

A1

A1

A1

A1

A2

A2

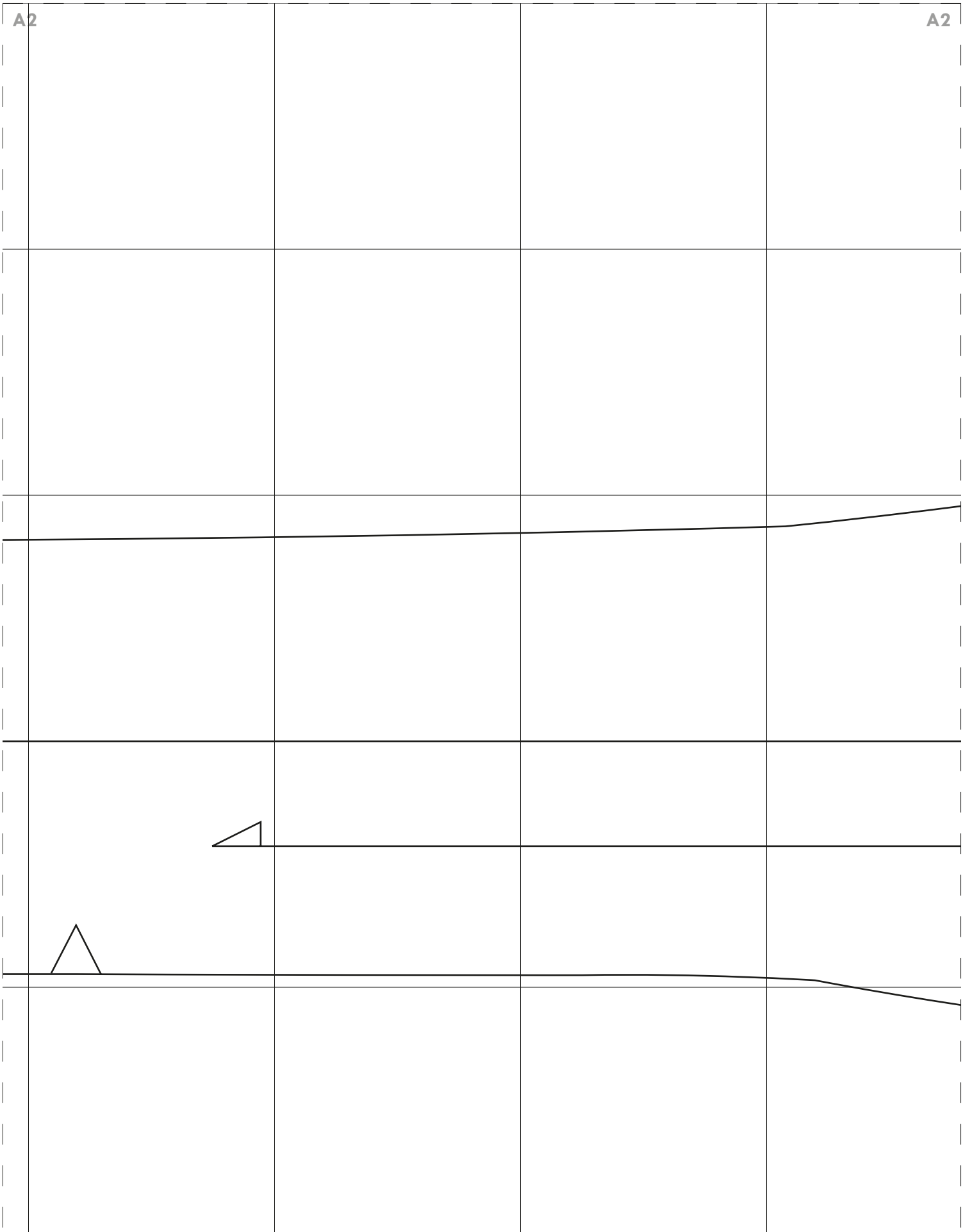

A2

A2

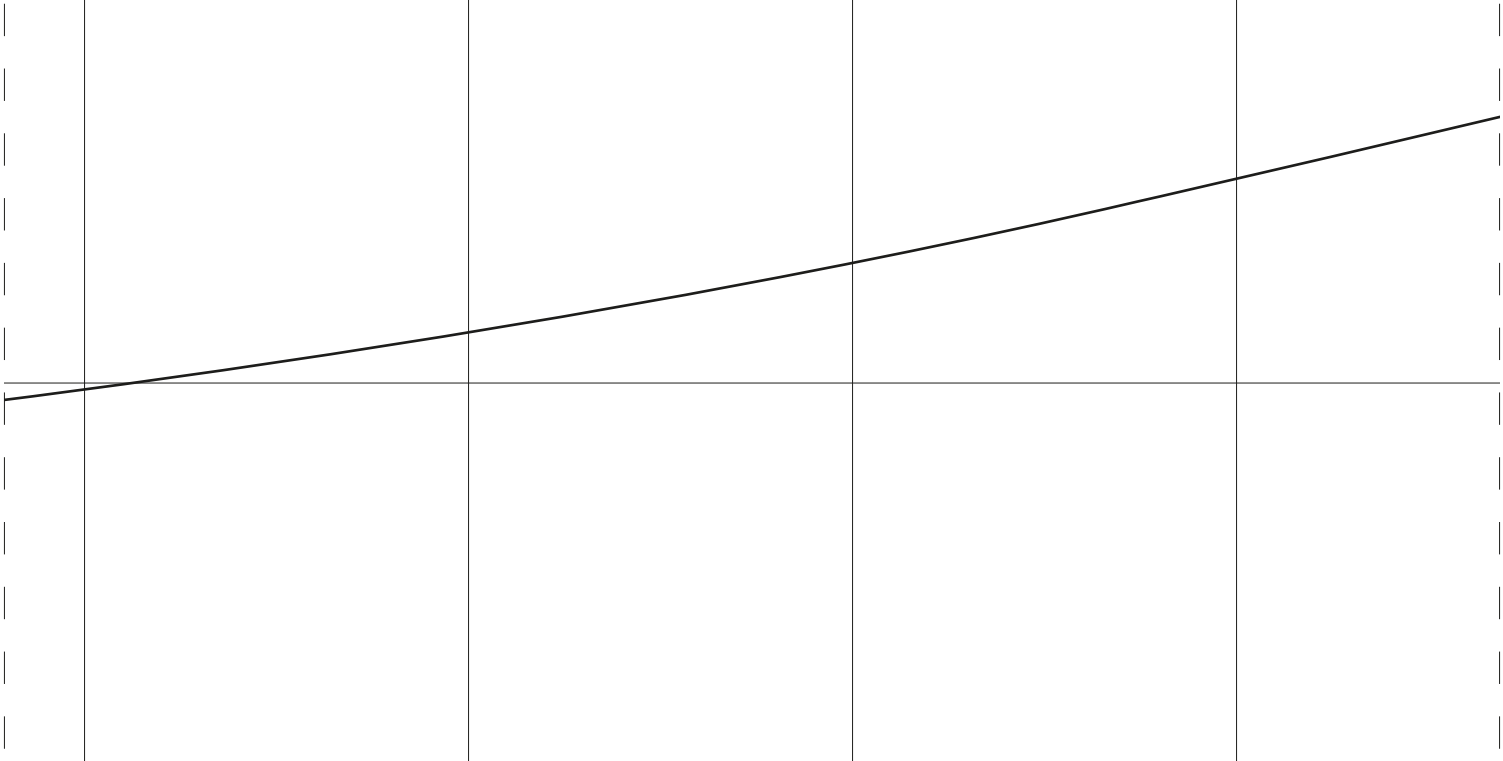

FRONT FACING  
Cut 2 fabric

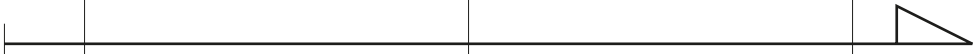

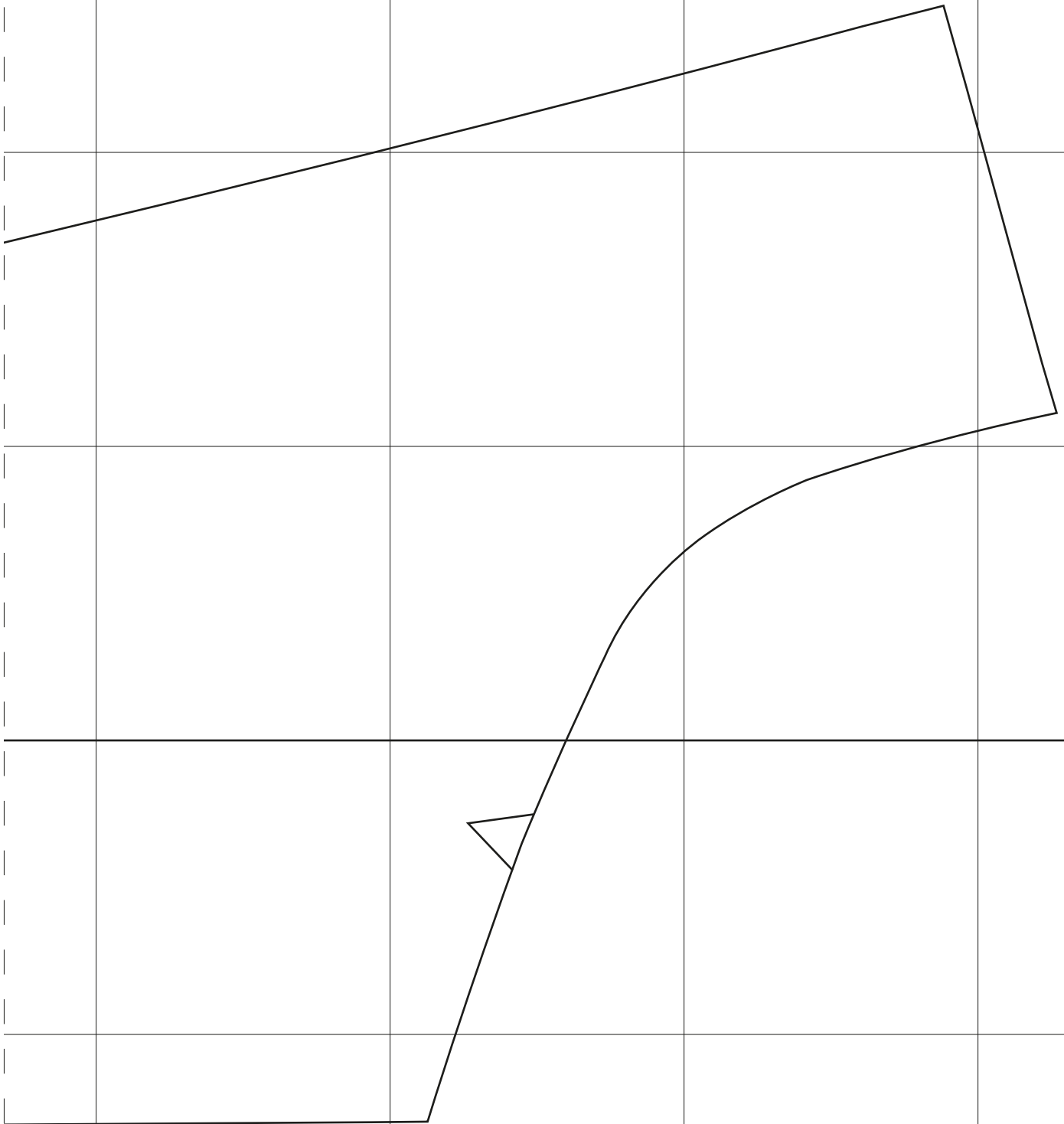

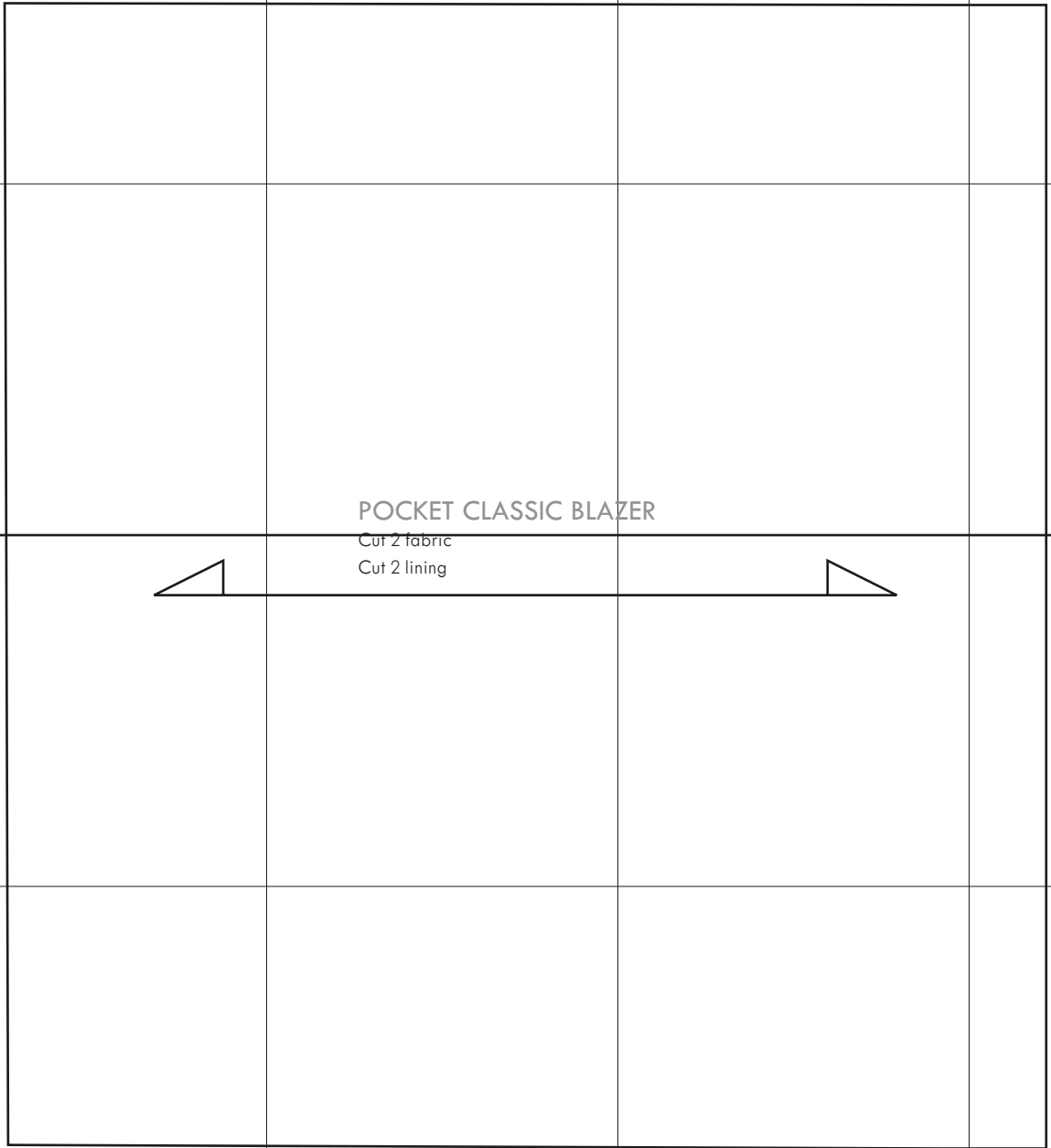

POCKET CLASSIC BLAZER

Cut 2 fabric

Cut 2 lining

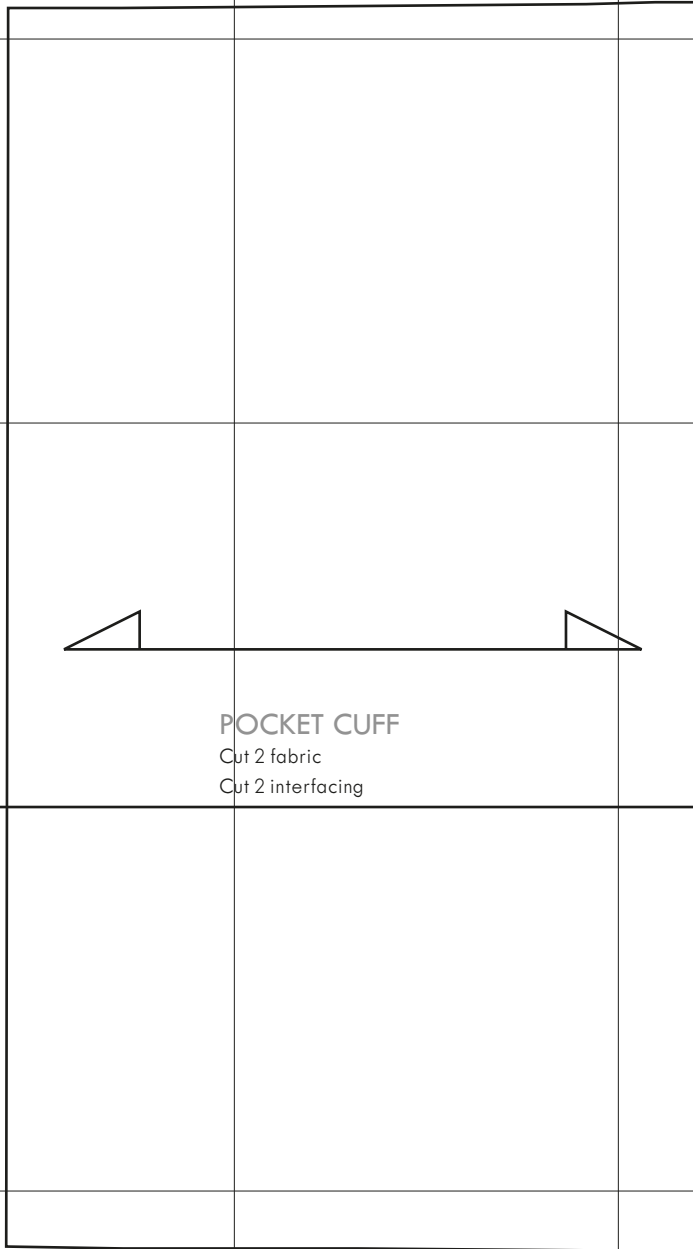

POCKET CUFF

Cut 2 fabric

Cut 2 interfacing

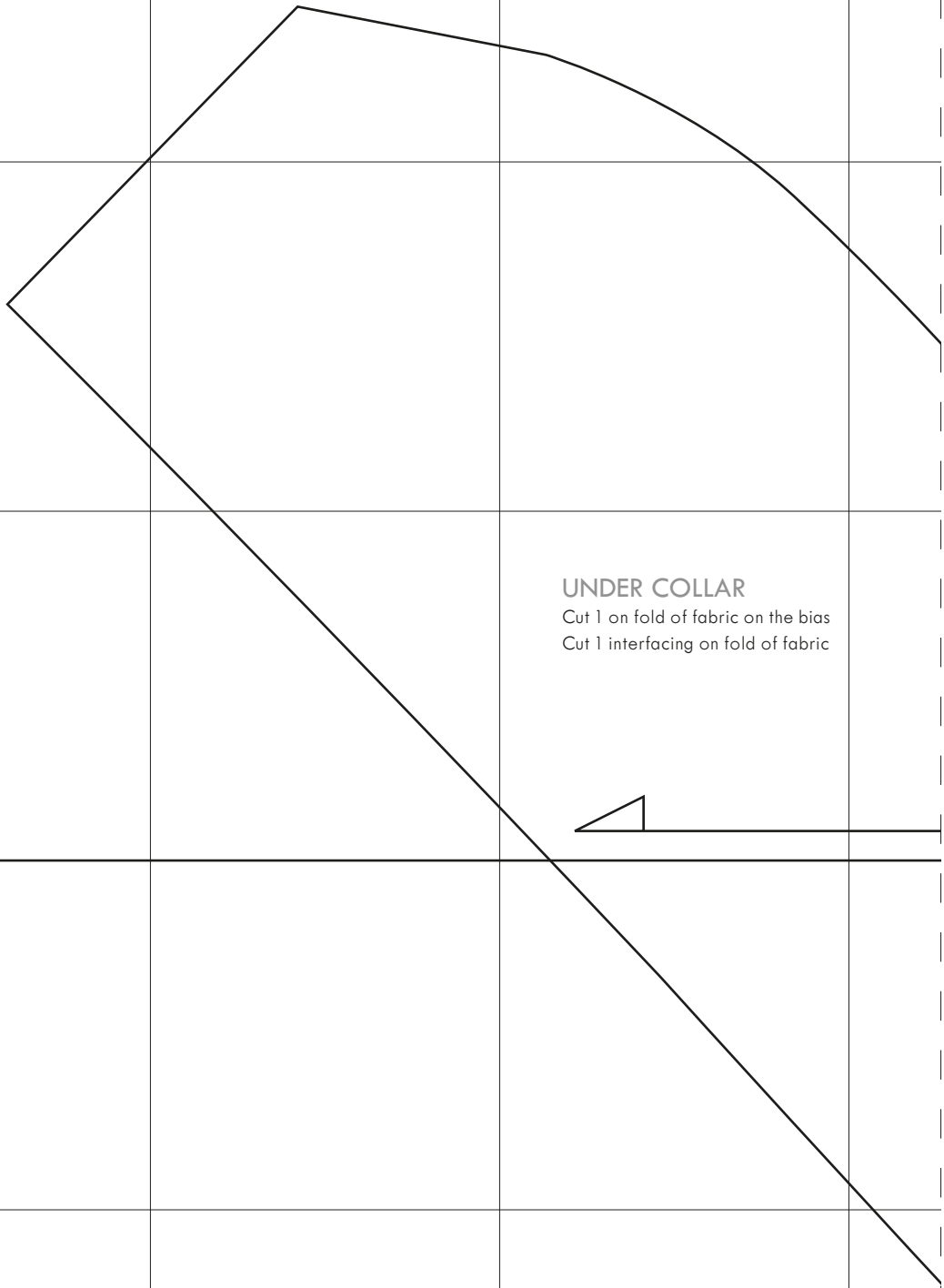

UNDER COLLAR

Cut 1 on fold of fabric on the bias  
Cut 1 interfacing on fold of fabric

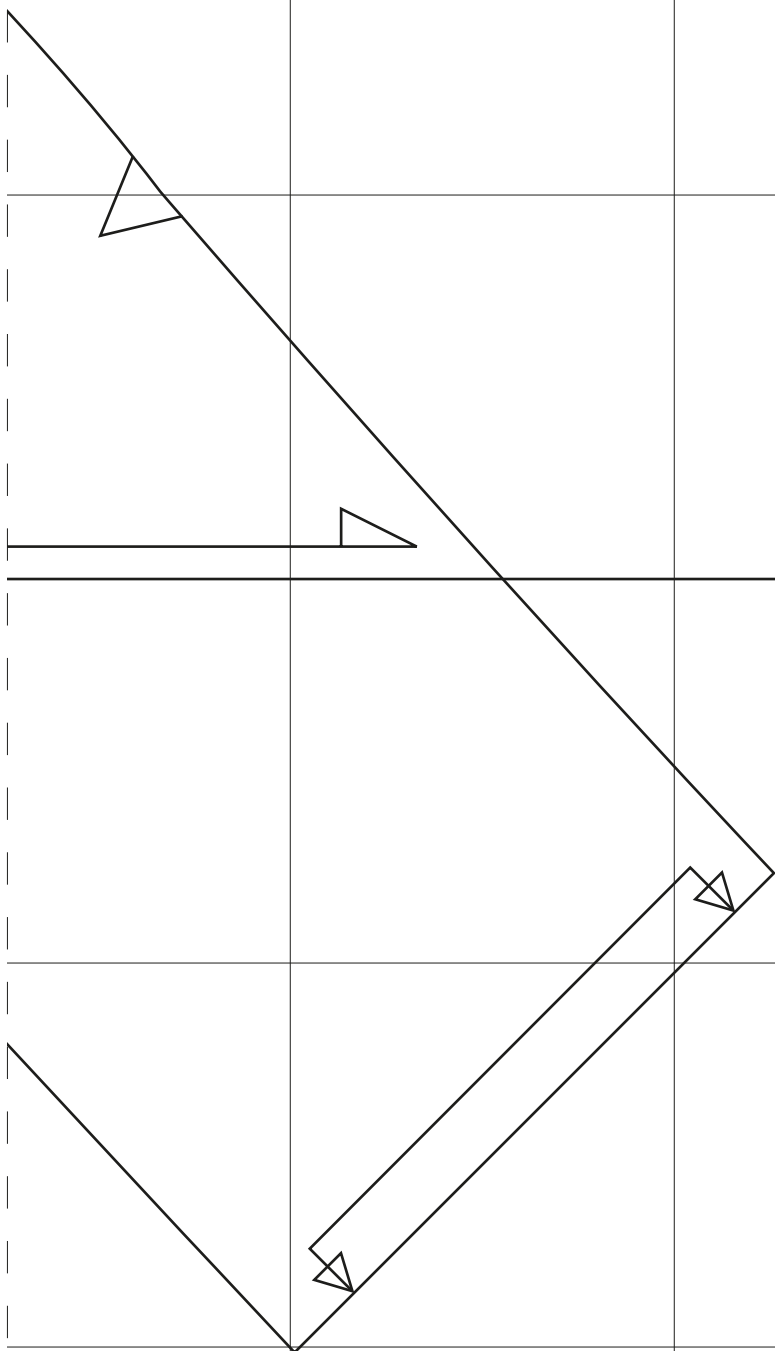



B1

B1

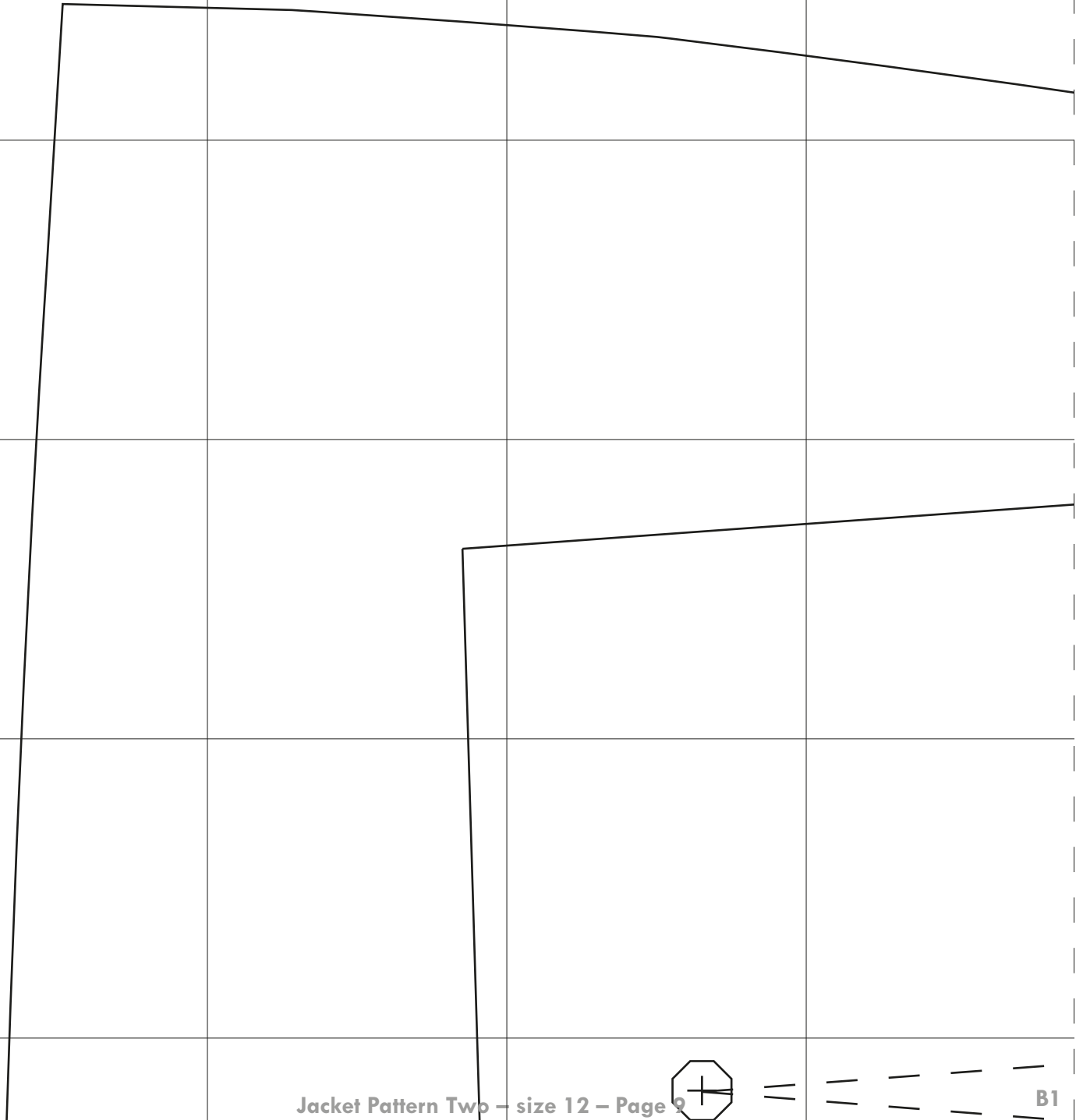

B1



B1

B2

B2

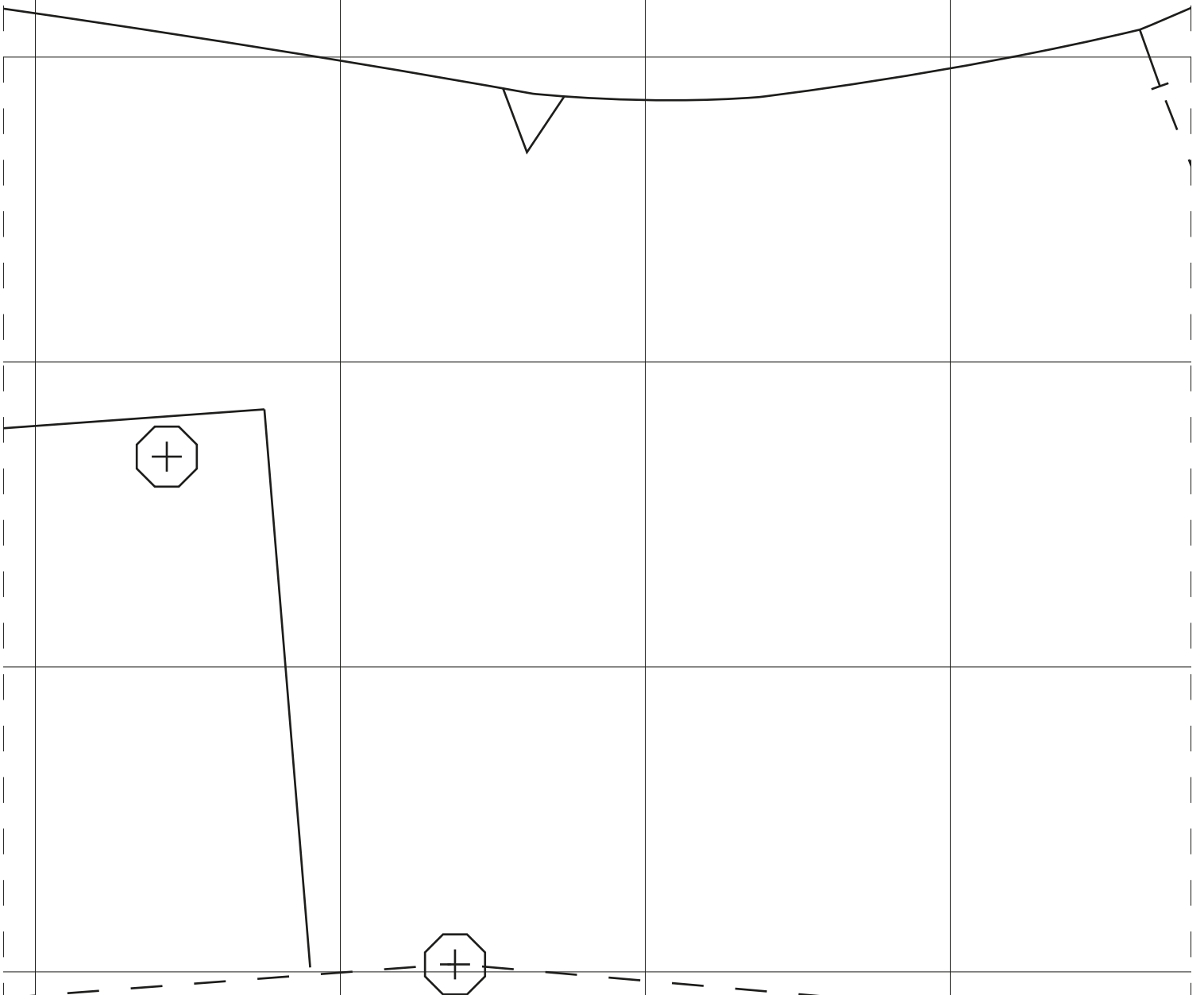

B2

B2

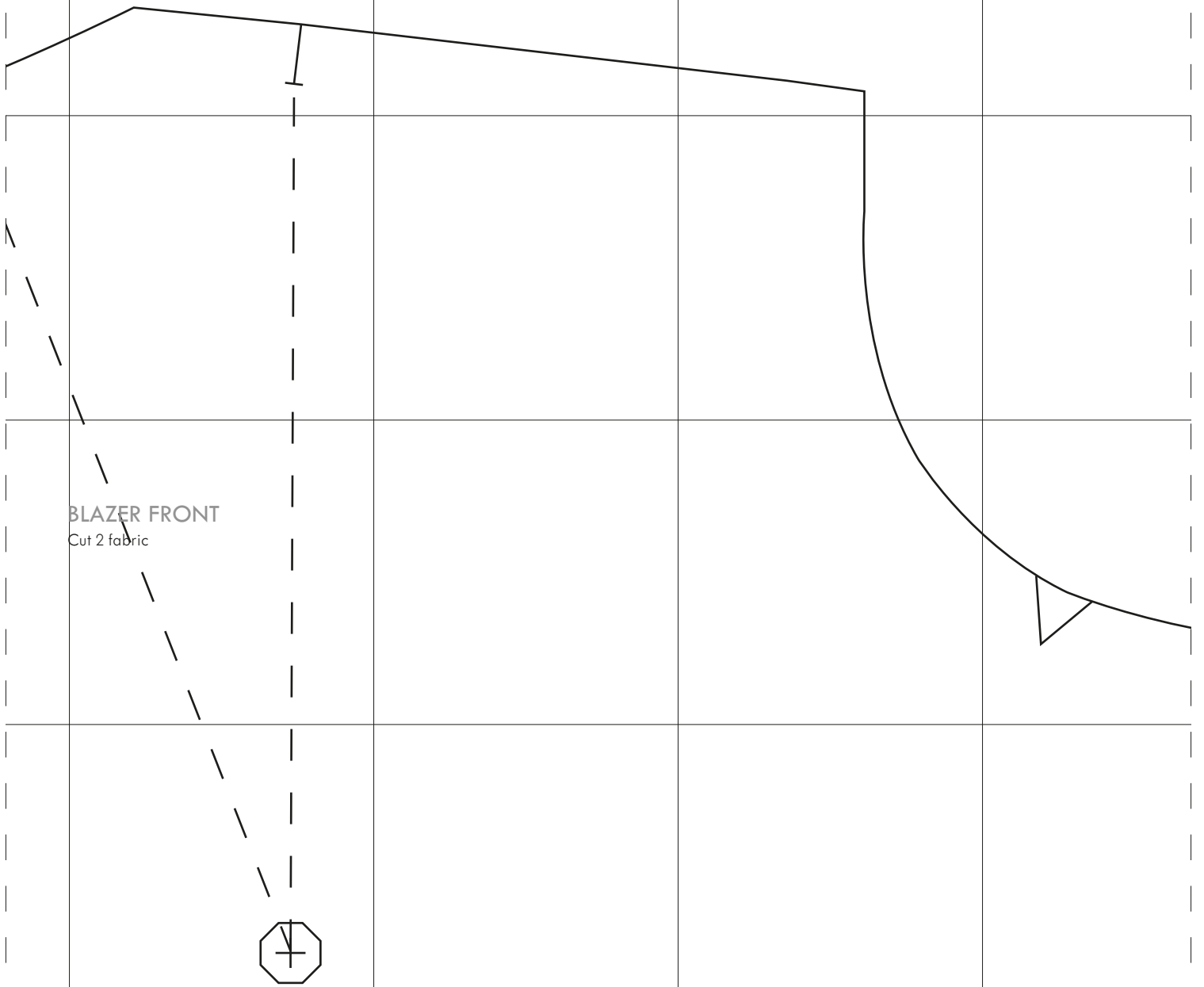

**BLAZER FRONT**  
Cut 2 fabric



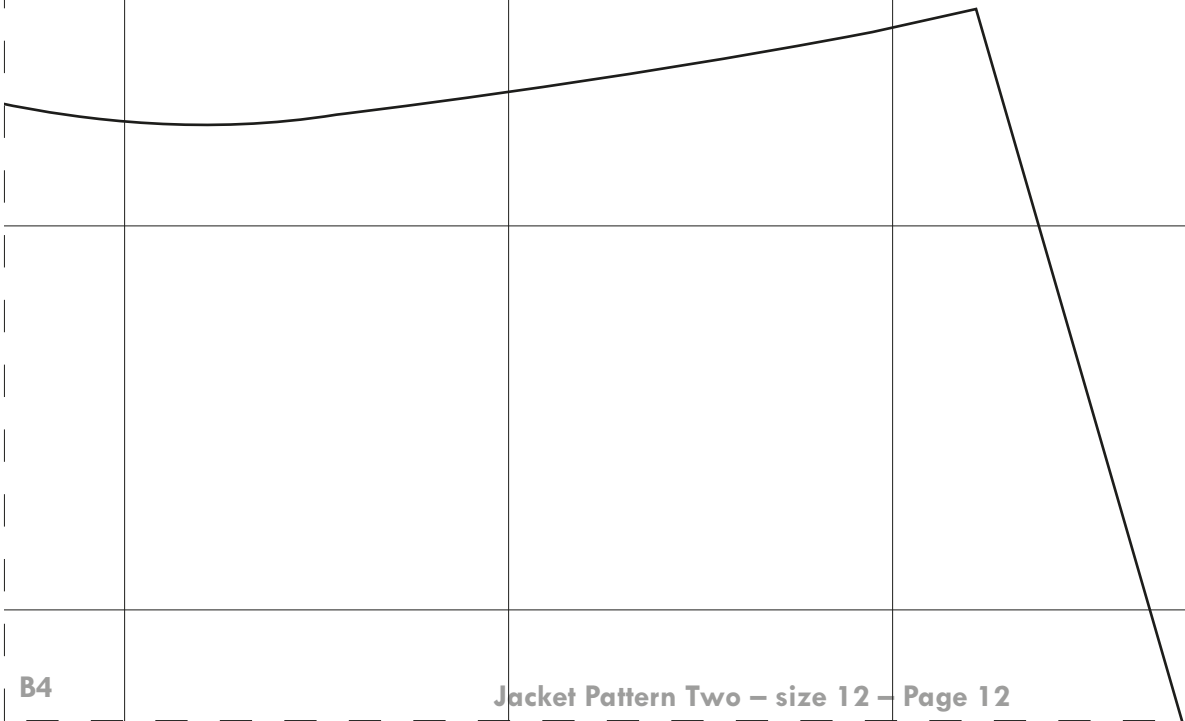

B5

B5

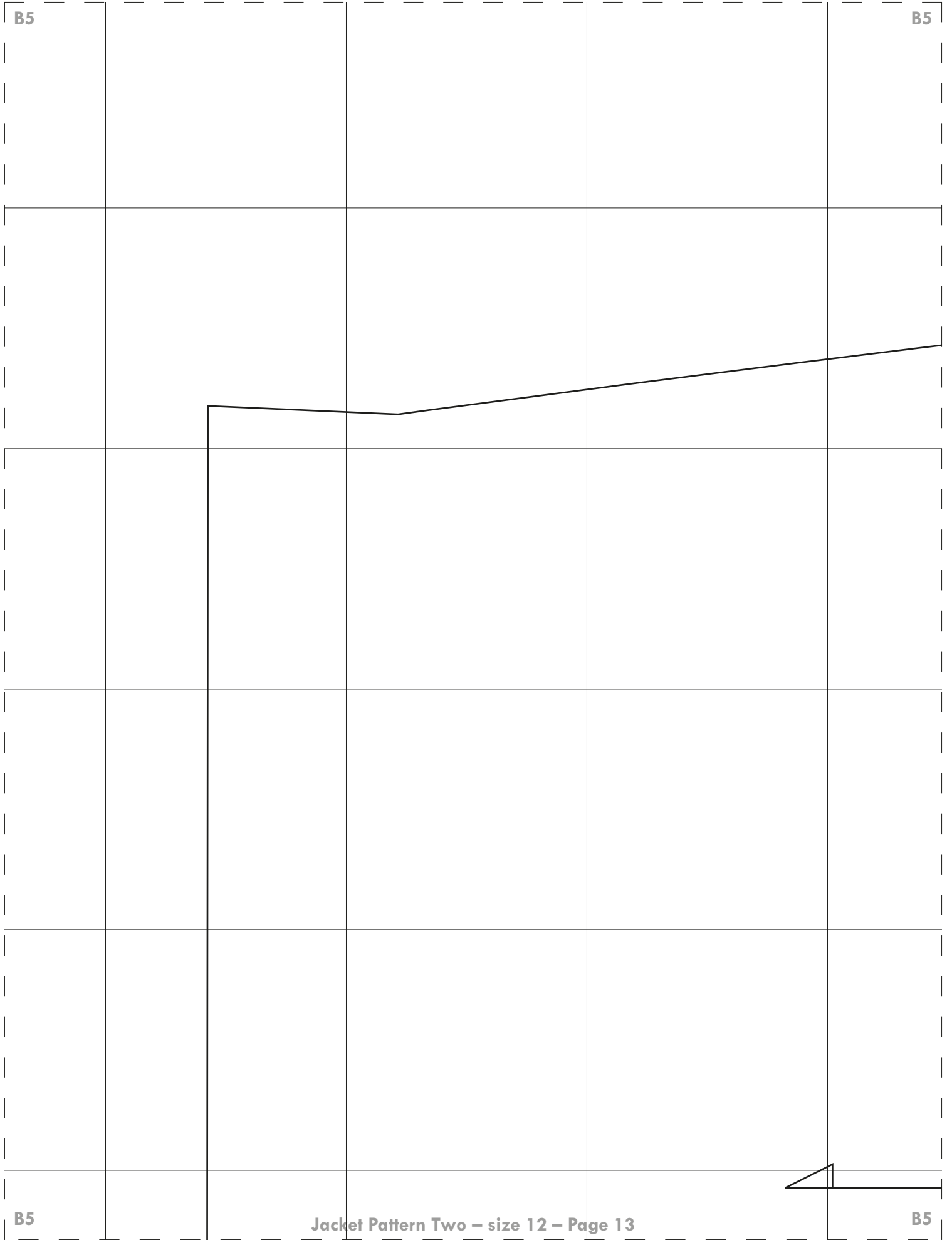

B5

B5

B6

B6

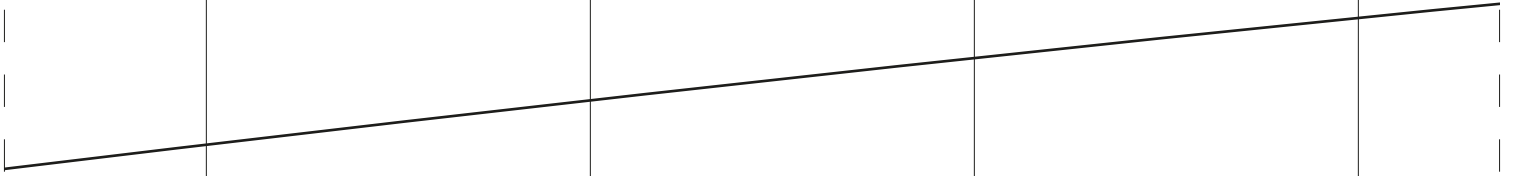

SLEEVE  
Cut 2 fabric

B6

B6

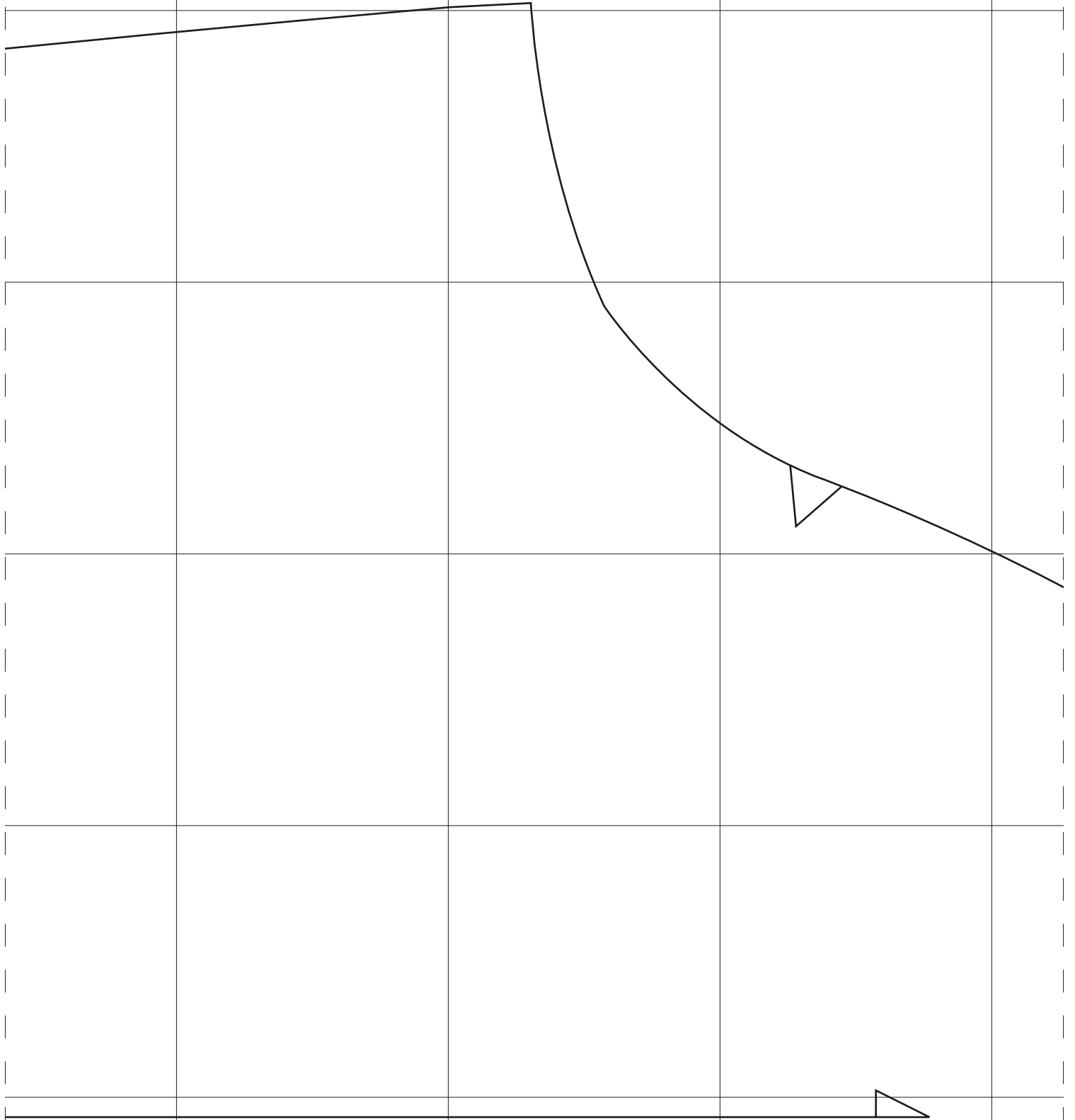

B8

B8

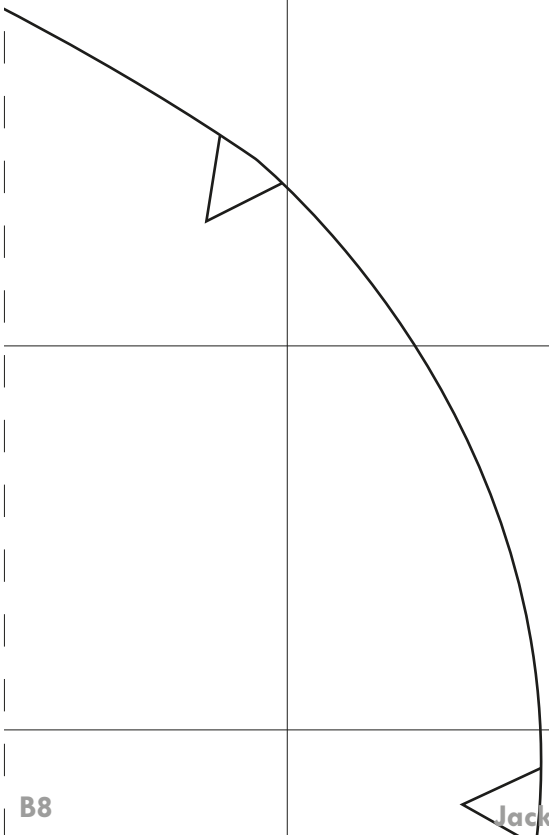

B8

B8



C1

C1

C1

C1

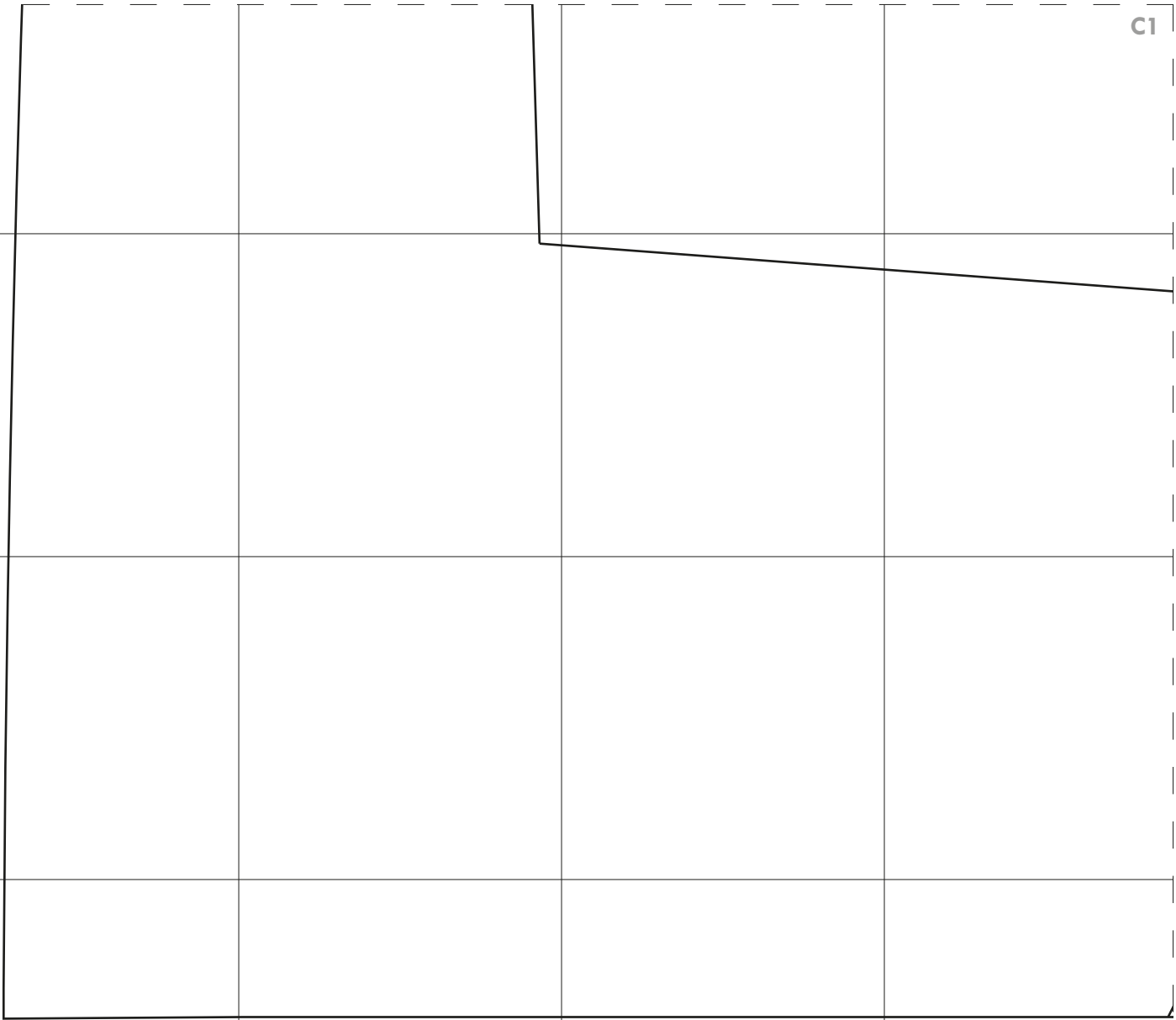

C2

C2

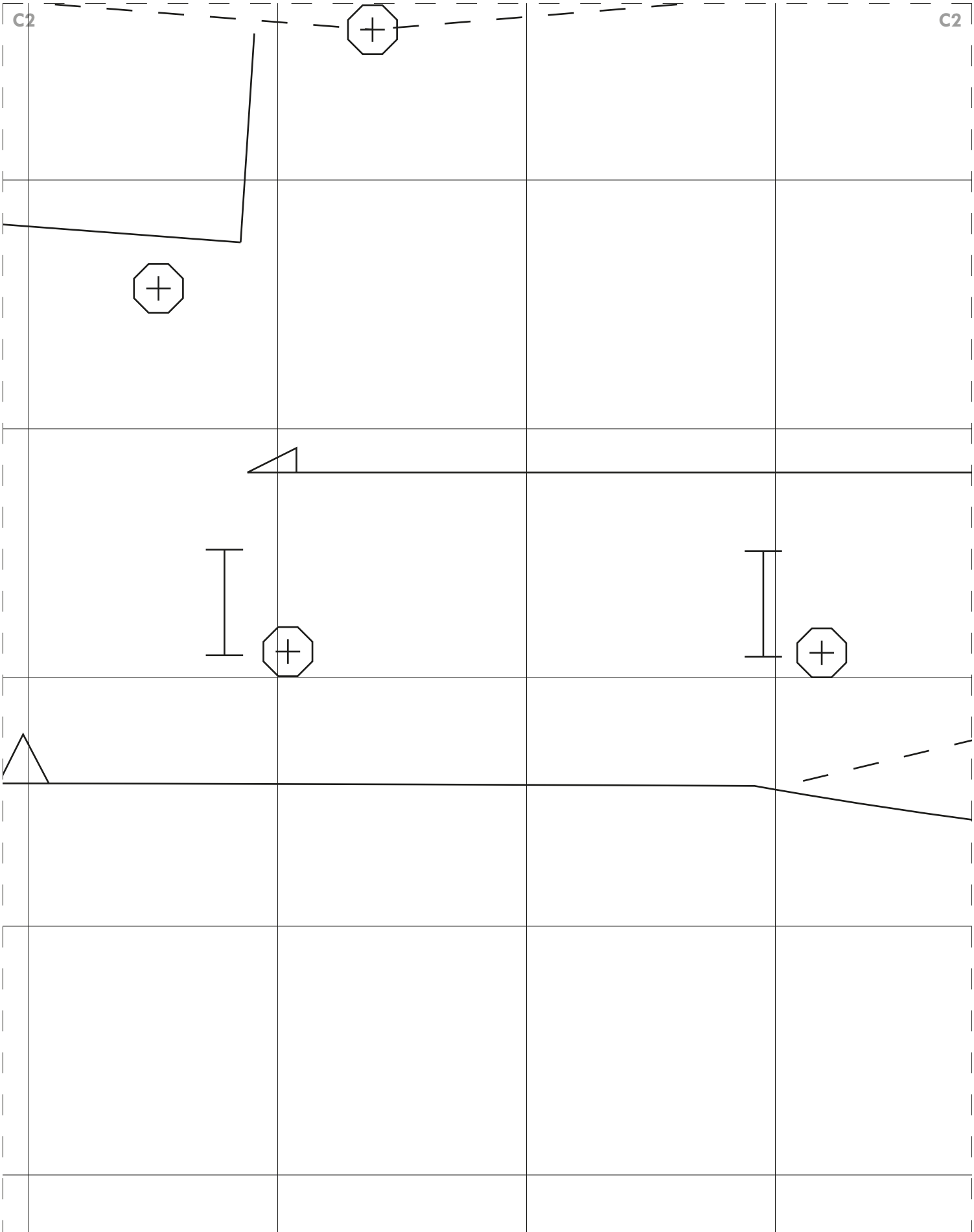

C2

C2

C3

C3

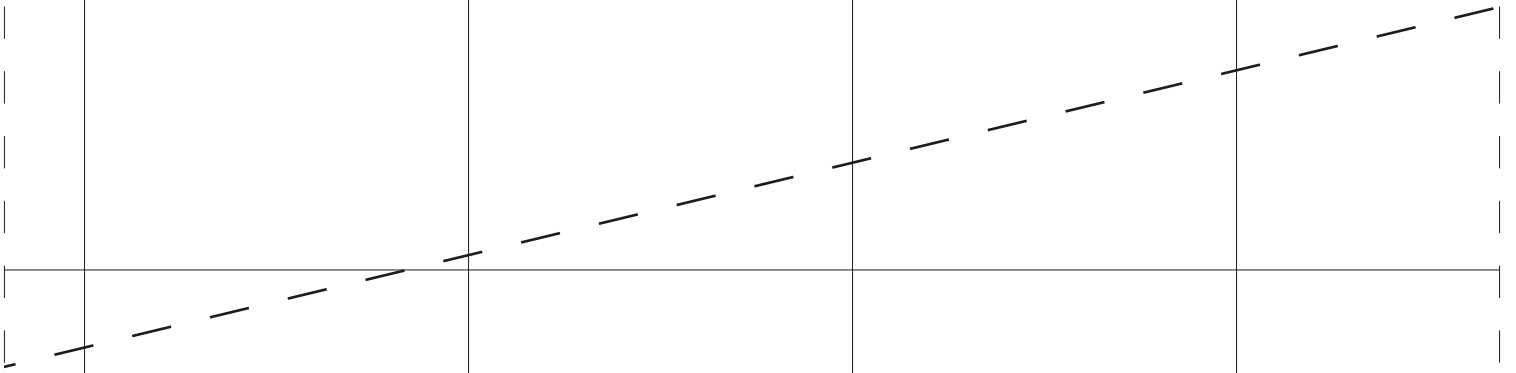

C3

C3

C4

C4

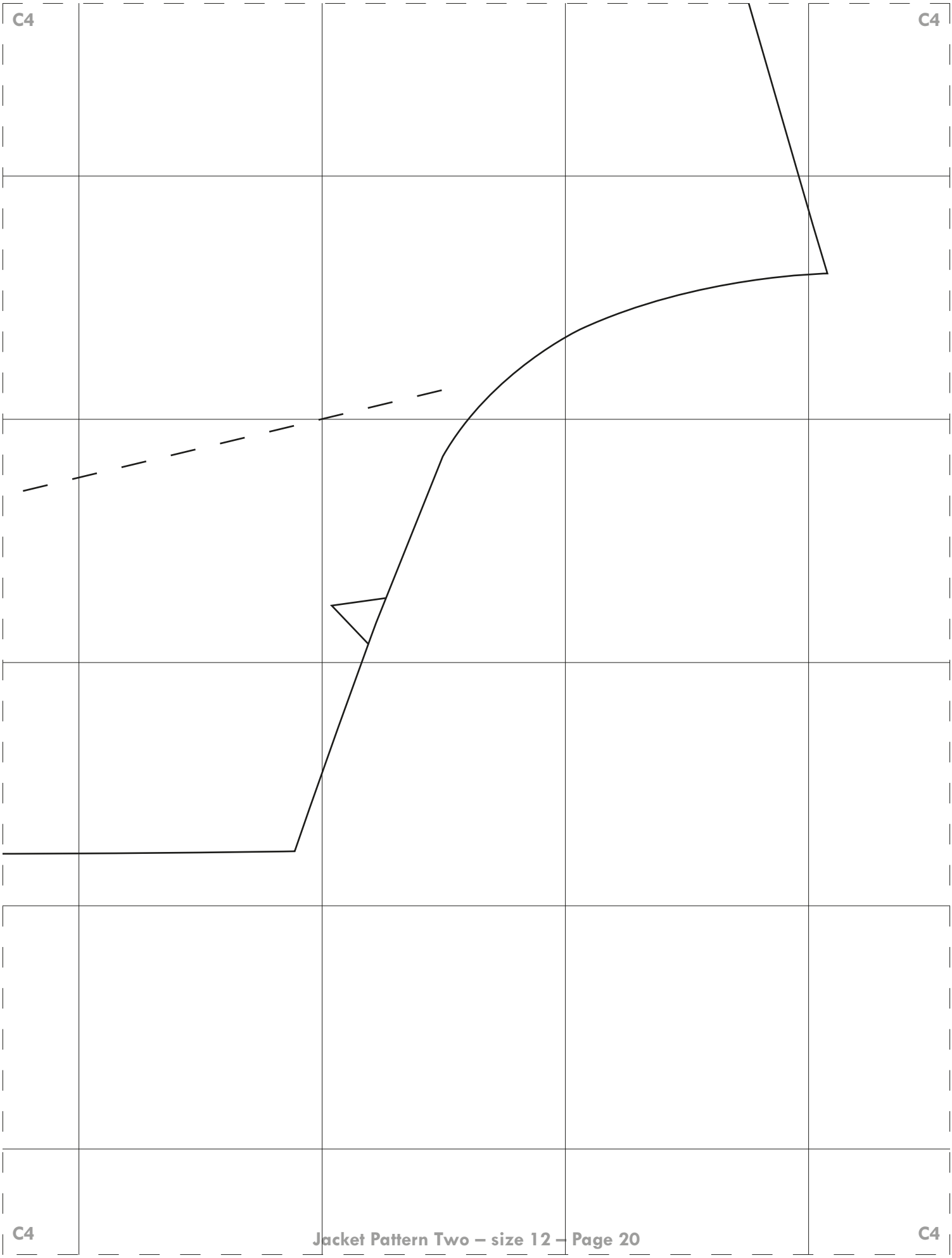

C4

C4

C5

C5



C5

C5

C6

C6

C6

C6

C7

C7

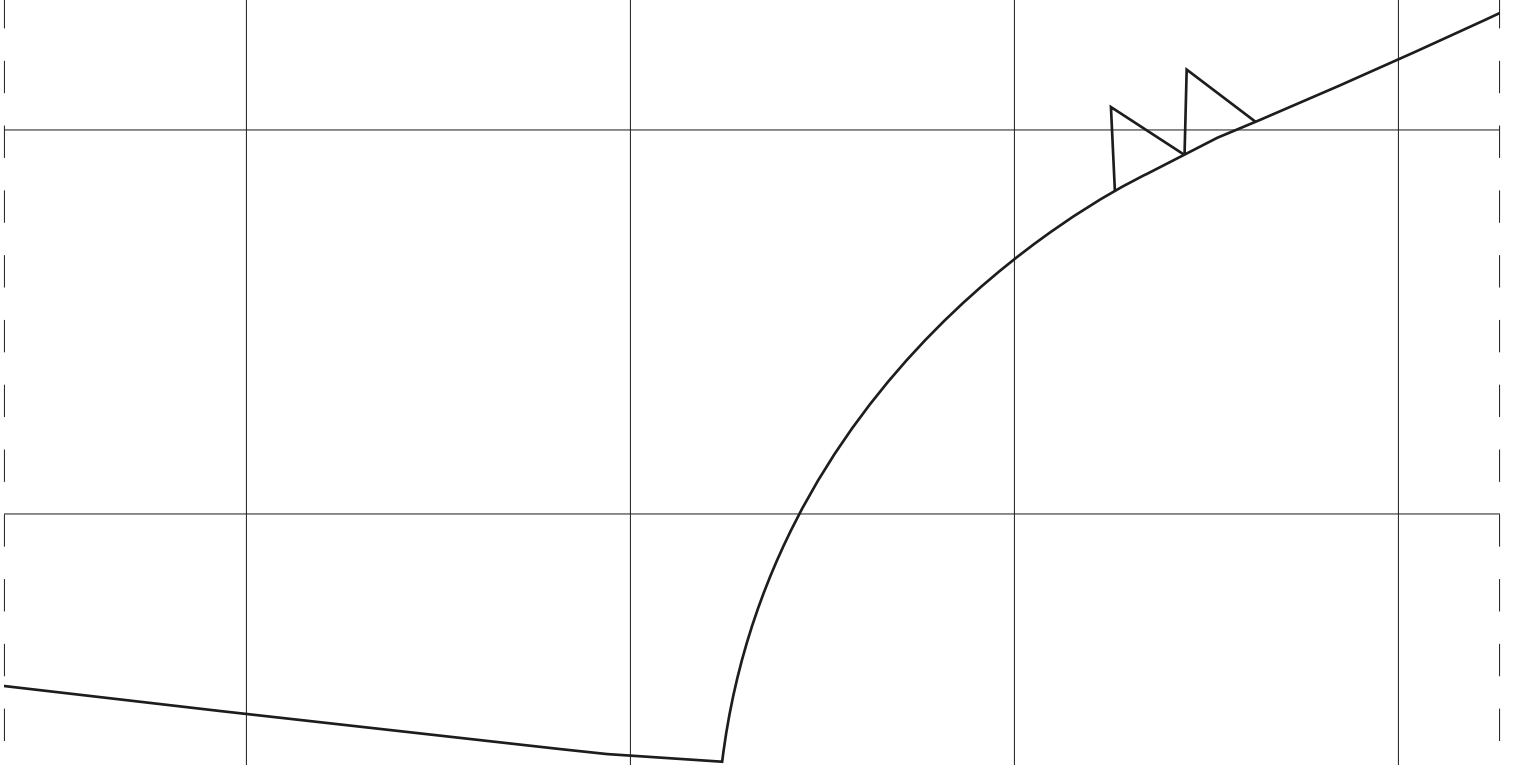

C7

C7

C8

C8

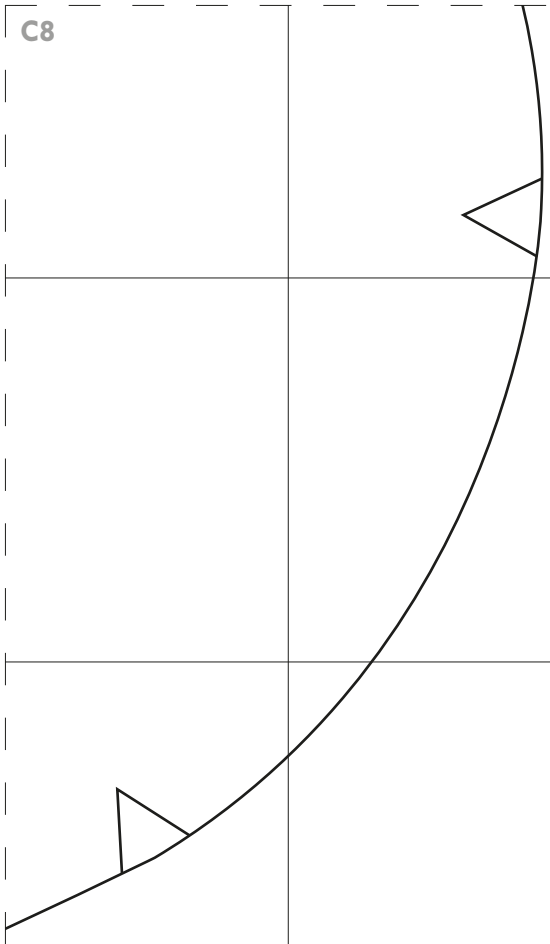

C8

C8



D1

D1

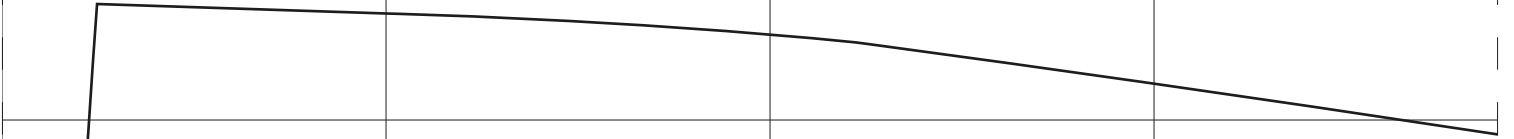

D1

D1

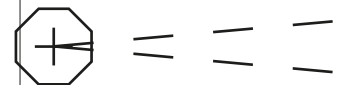

D2

D2

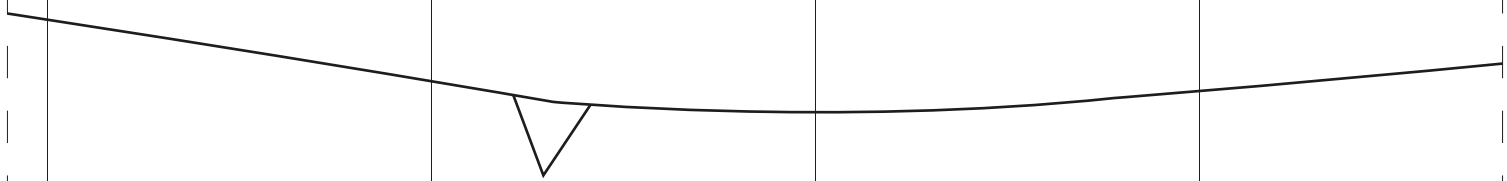

BLAZER BACK  
Cut 2 fabric

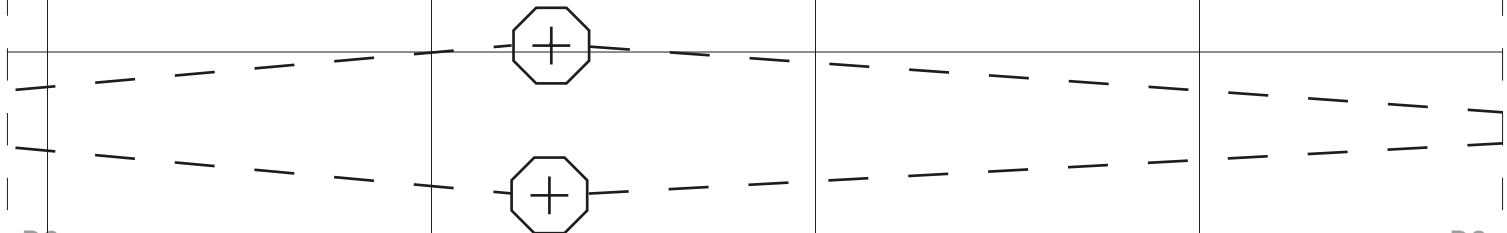

D2

D2

D3

D3

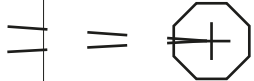
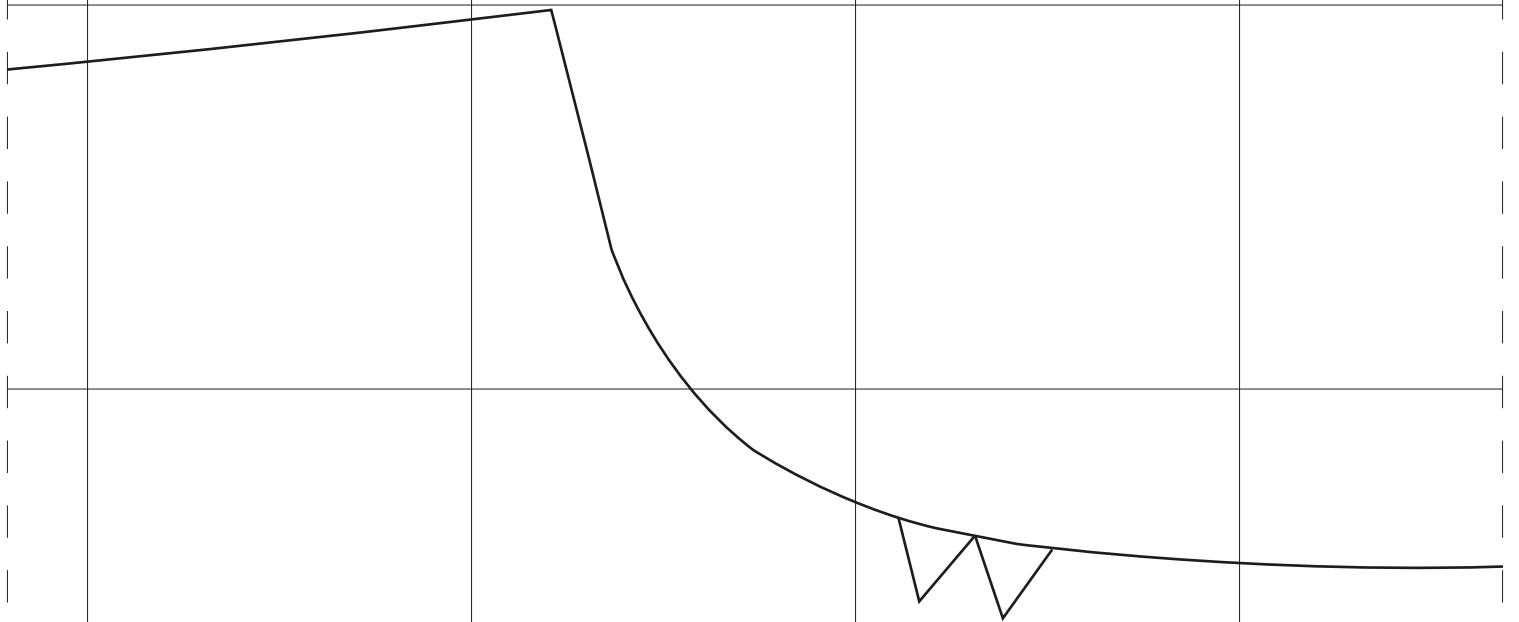

D3

D3

D4

D4

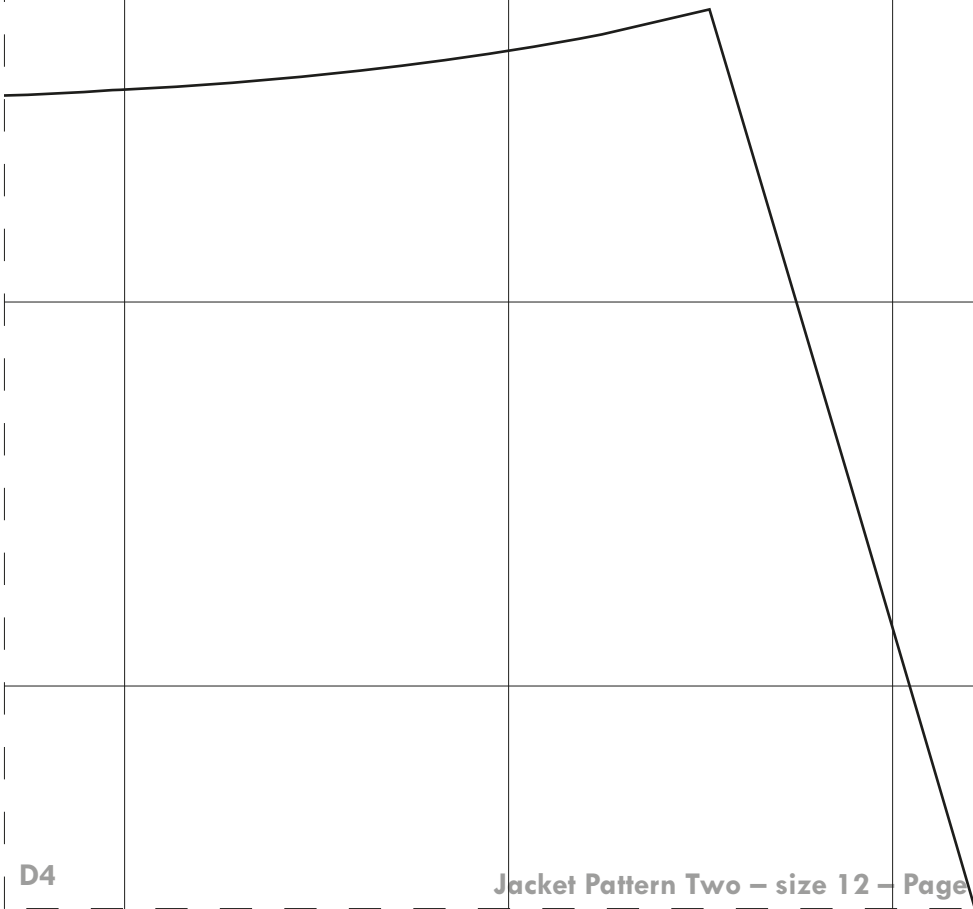

D4

D4

**BACK NECK FACING**

Cut 1 on fold of fabric

Cut 1 on fold of interfacing

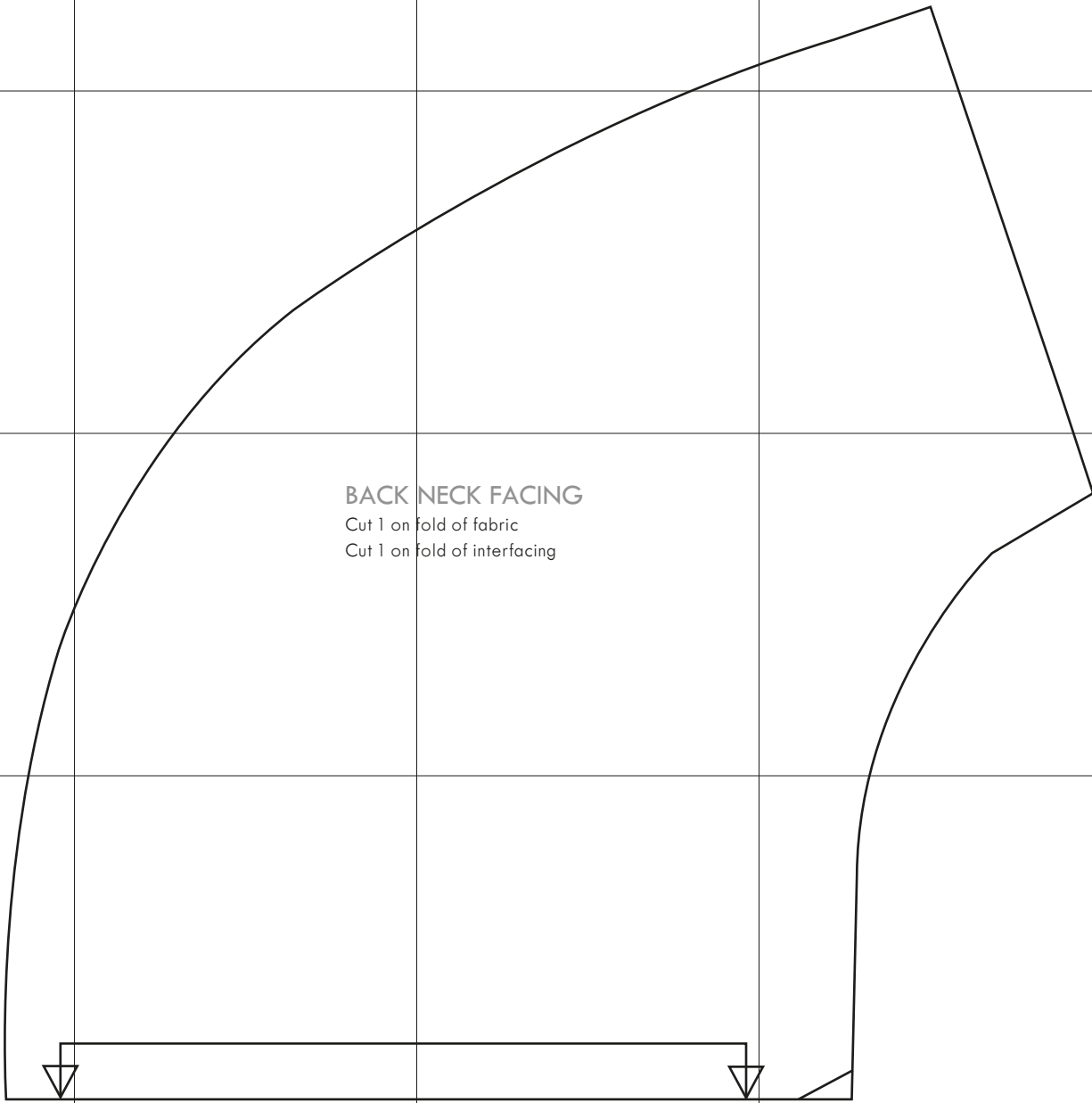

E1

E1

E1

E1



E3

E3

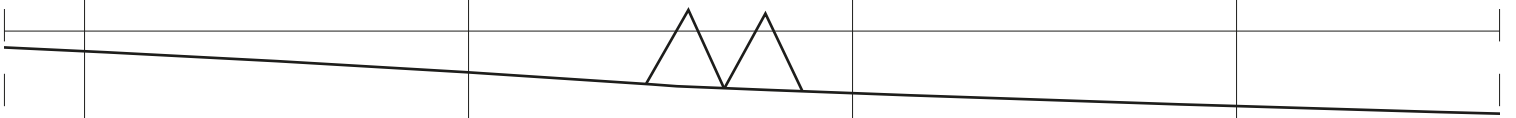

E3

E3



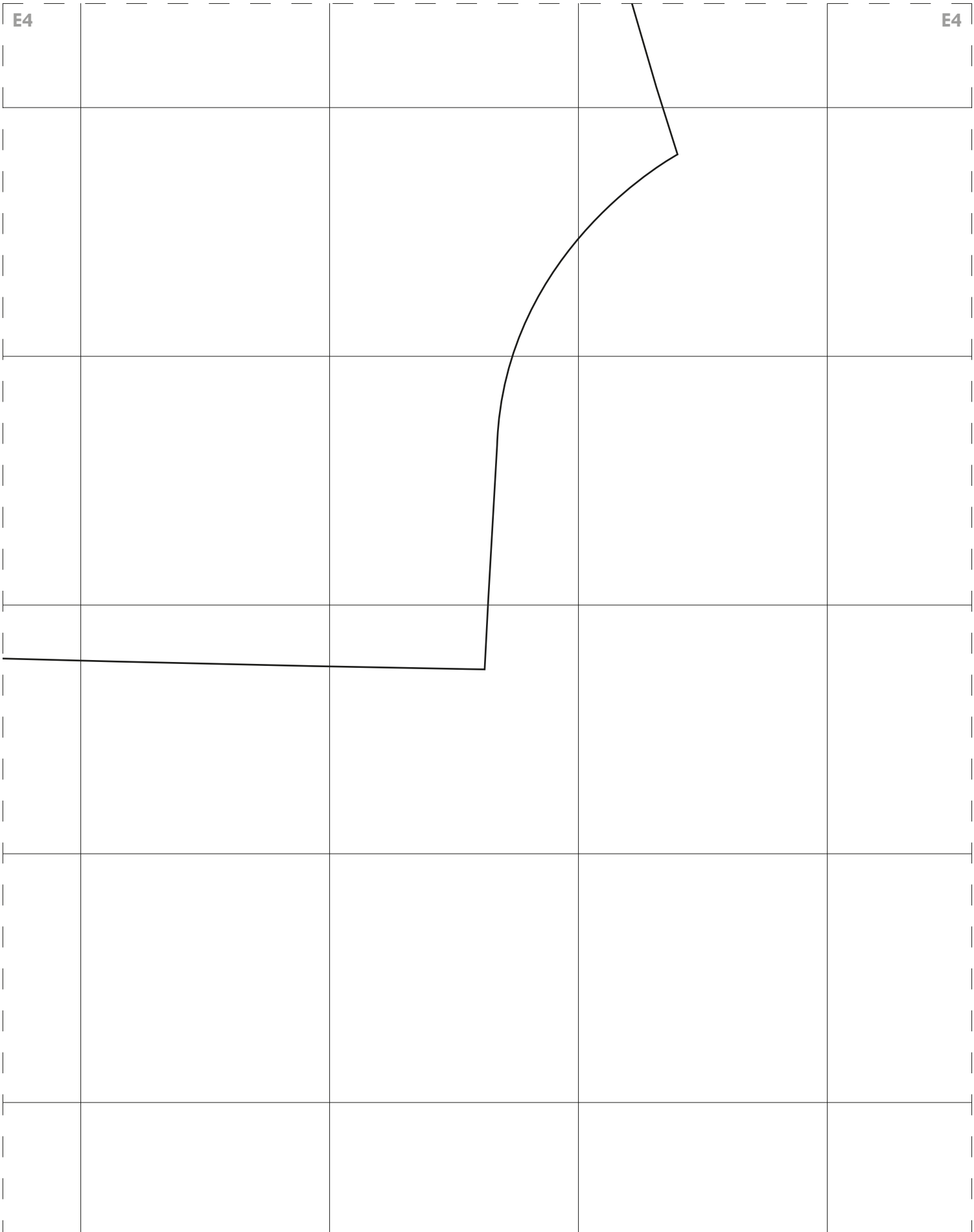

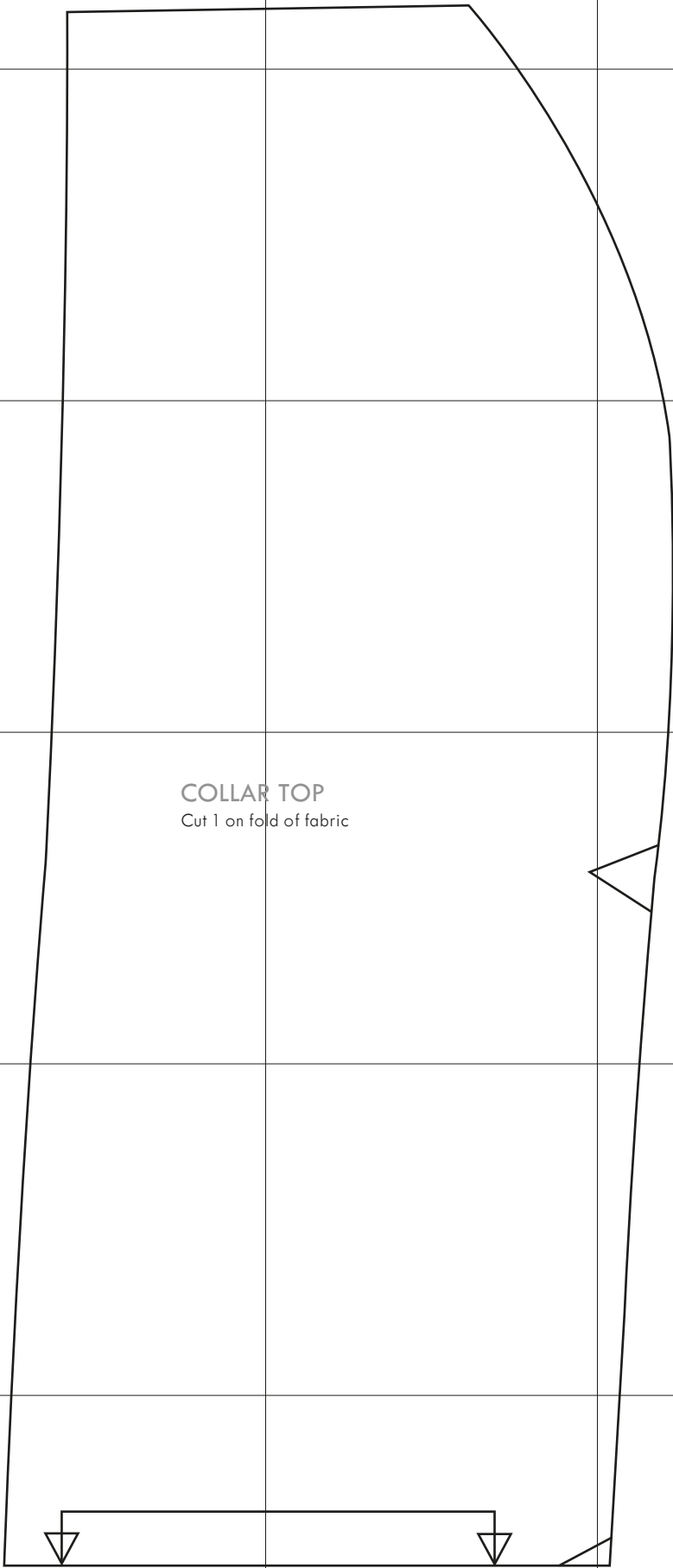

COLLAR TOP  
Cut 1 on fold of fabric