

A1

A1

A1

A1

A2

A2

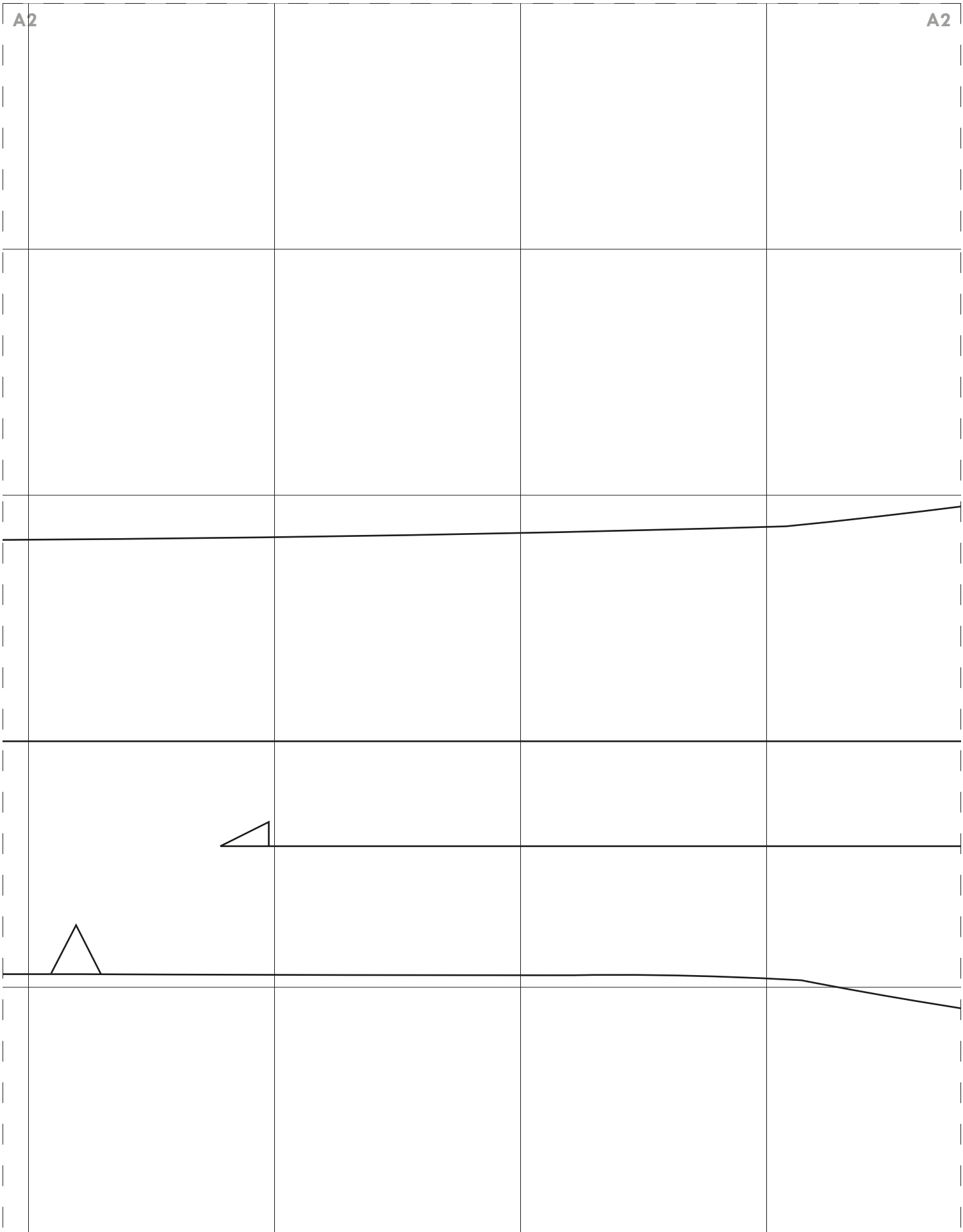

A2

A2

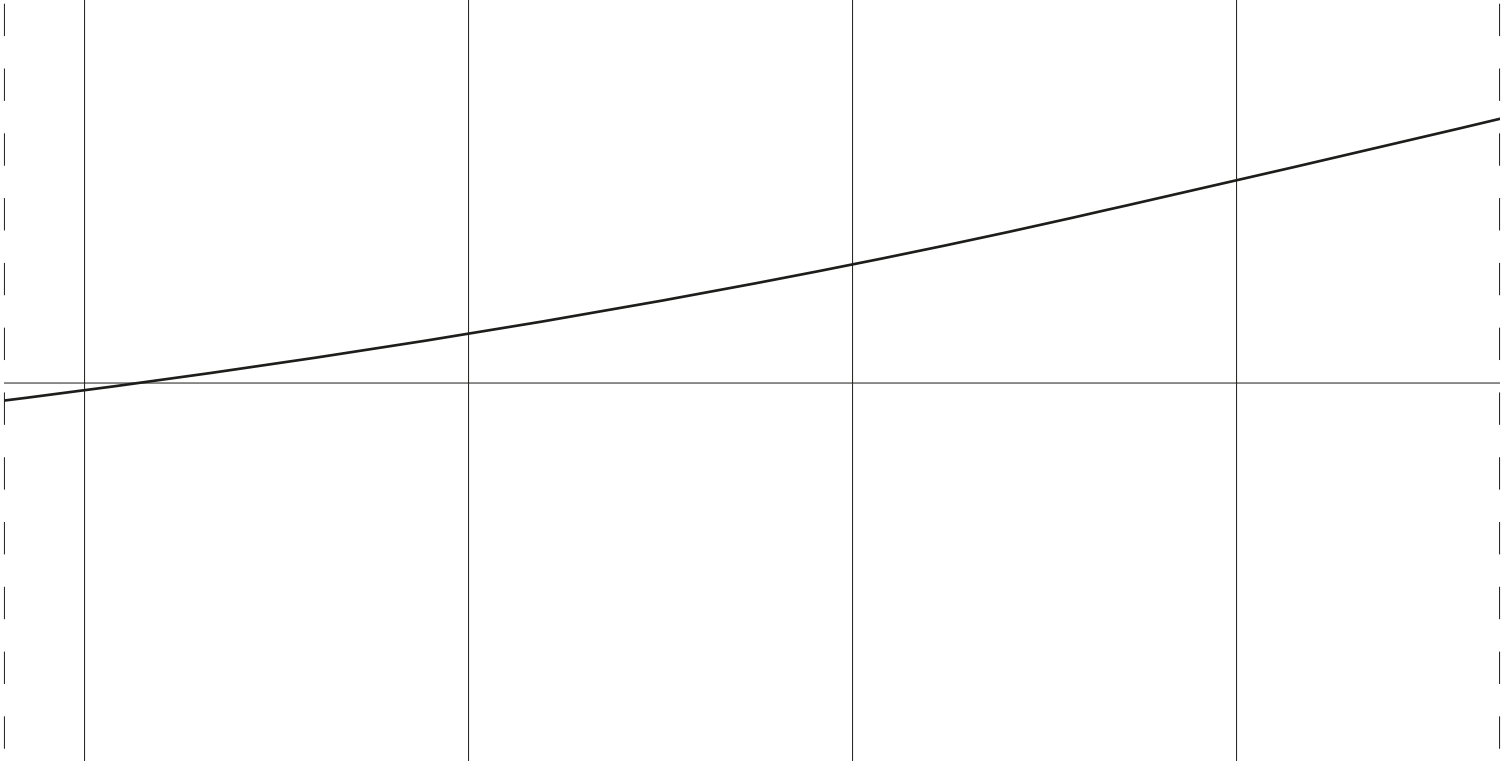

FRONT FACING
Cut 2 fabric

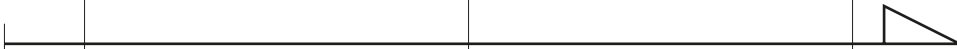

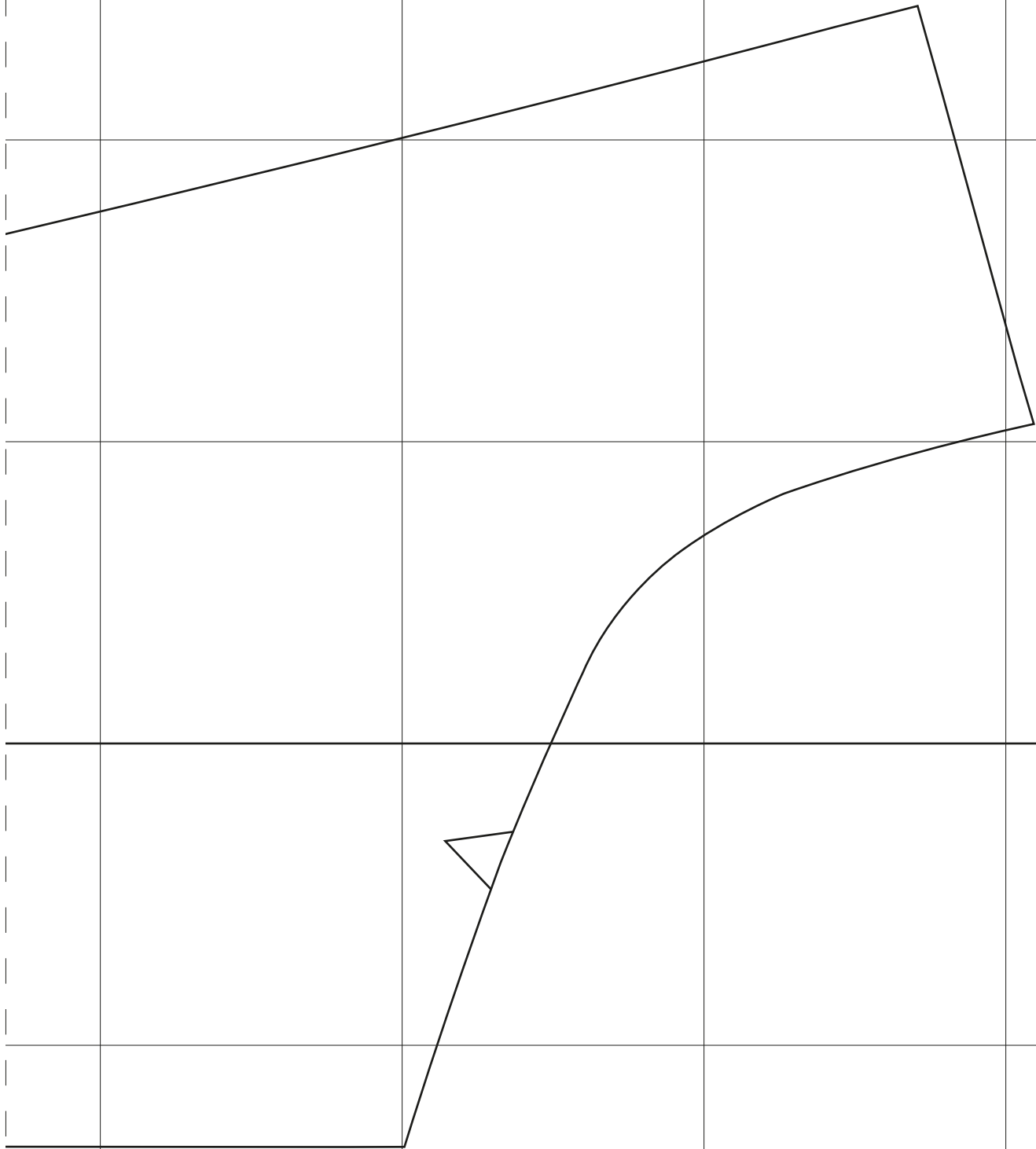

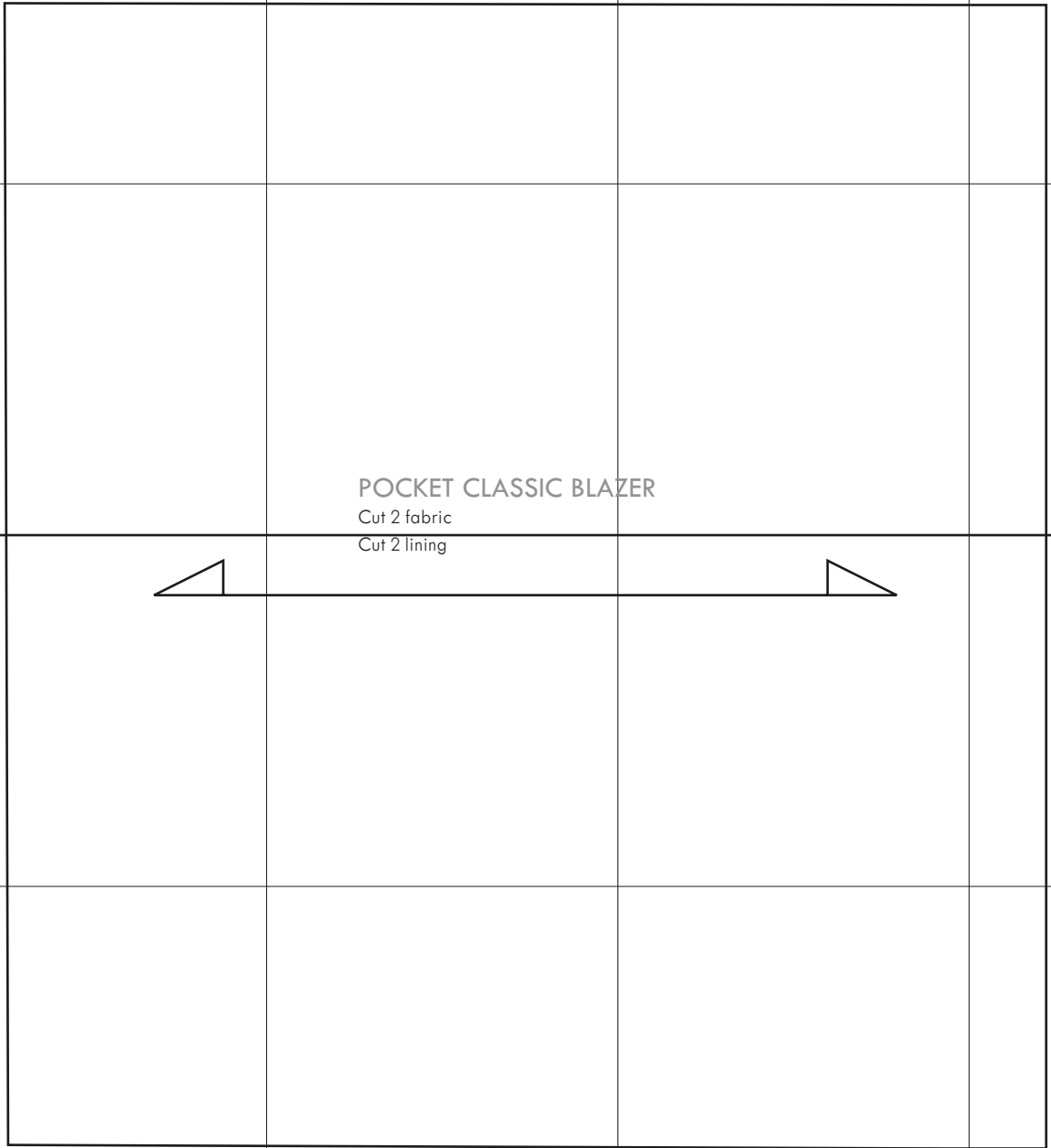

POCKET CLASSIC BLAZER

Cut 2 fabric

Cut 2 lining

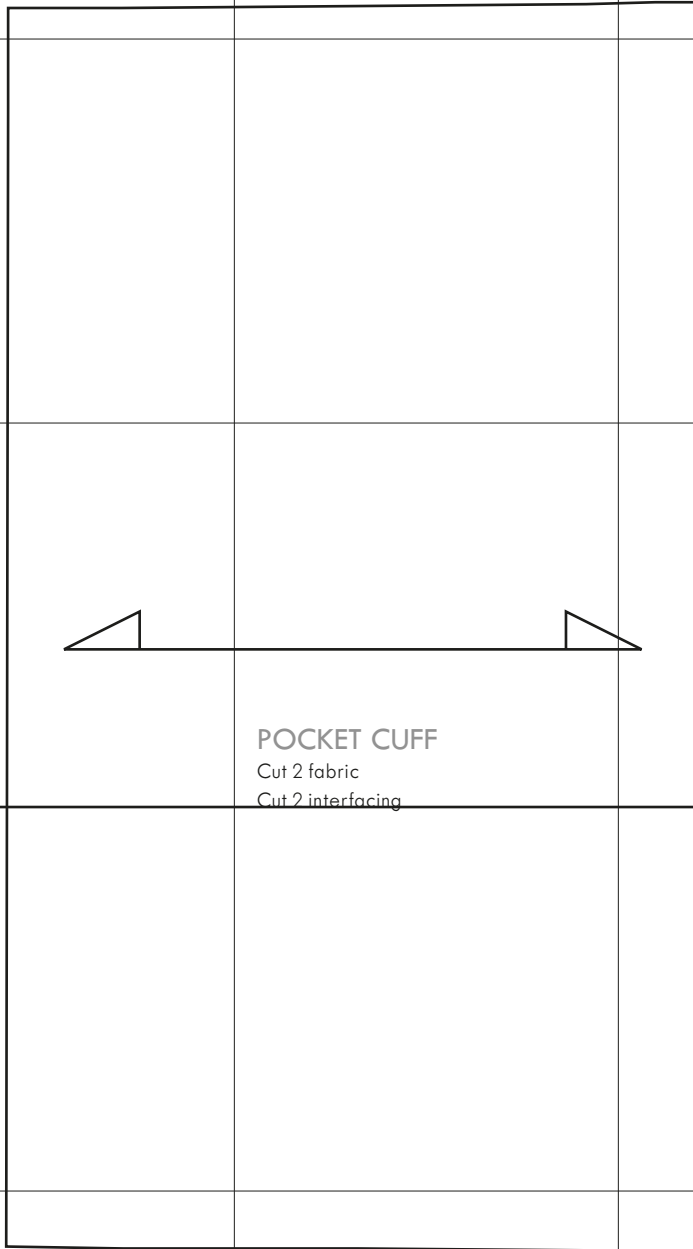

POCKET CUFF

Cut 2 fabric

Cut 2 interfacing

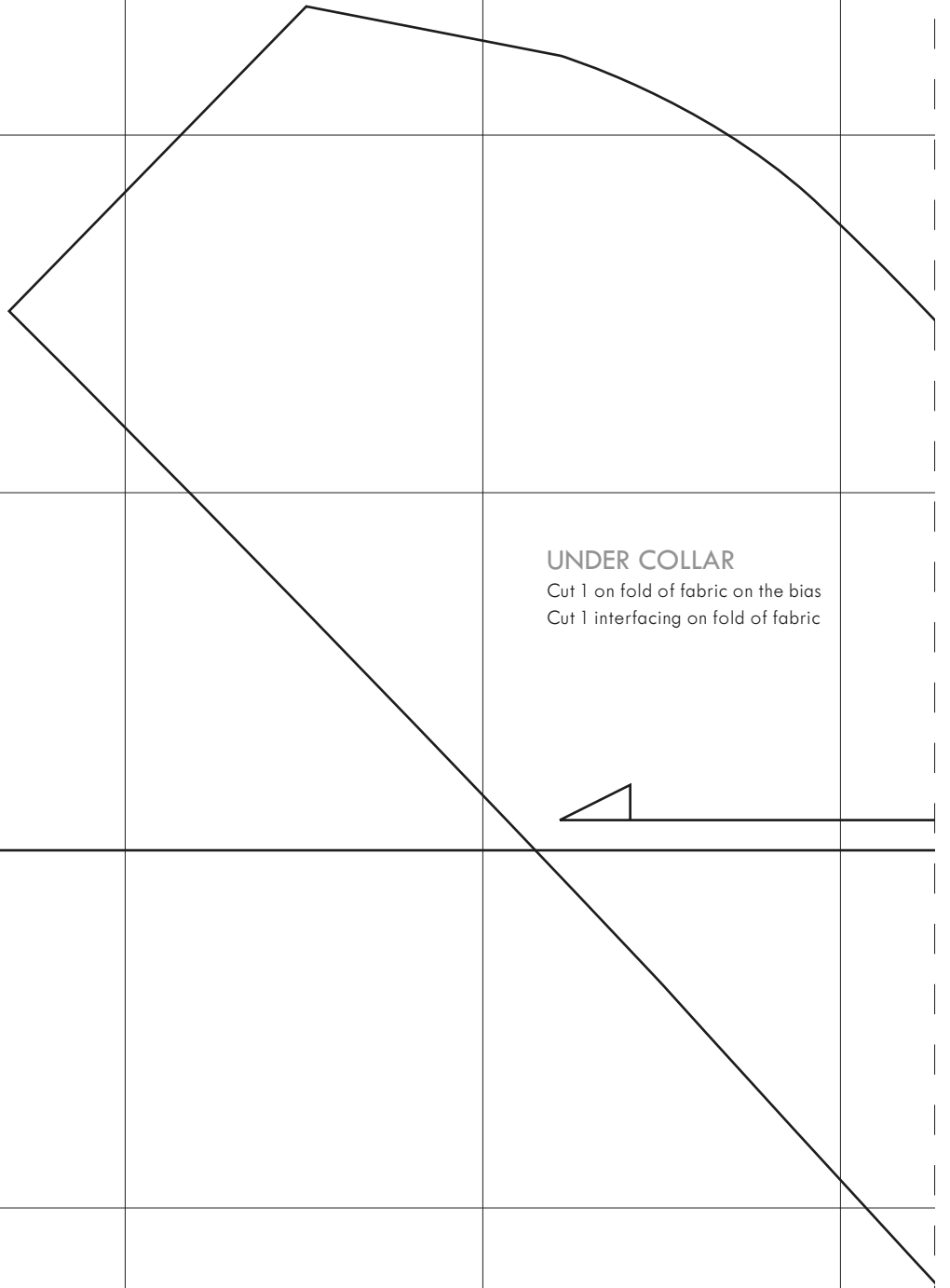

UNDER COLLAR

Cut 1 on fold of fabric on the bias
Cut 1 interfacing on fold of fabric

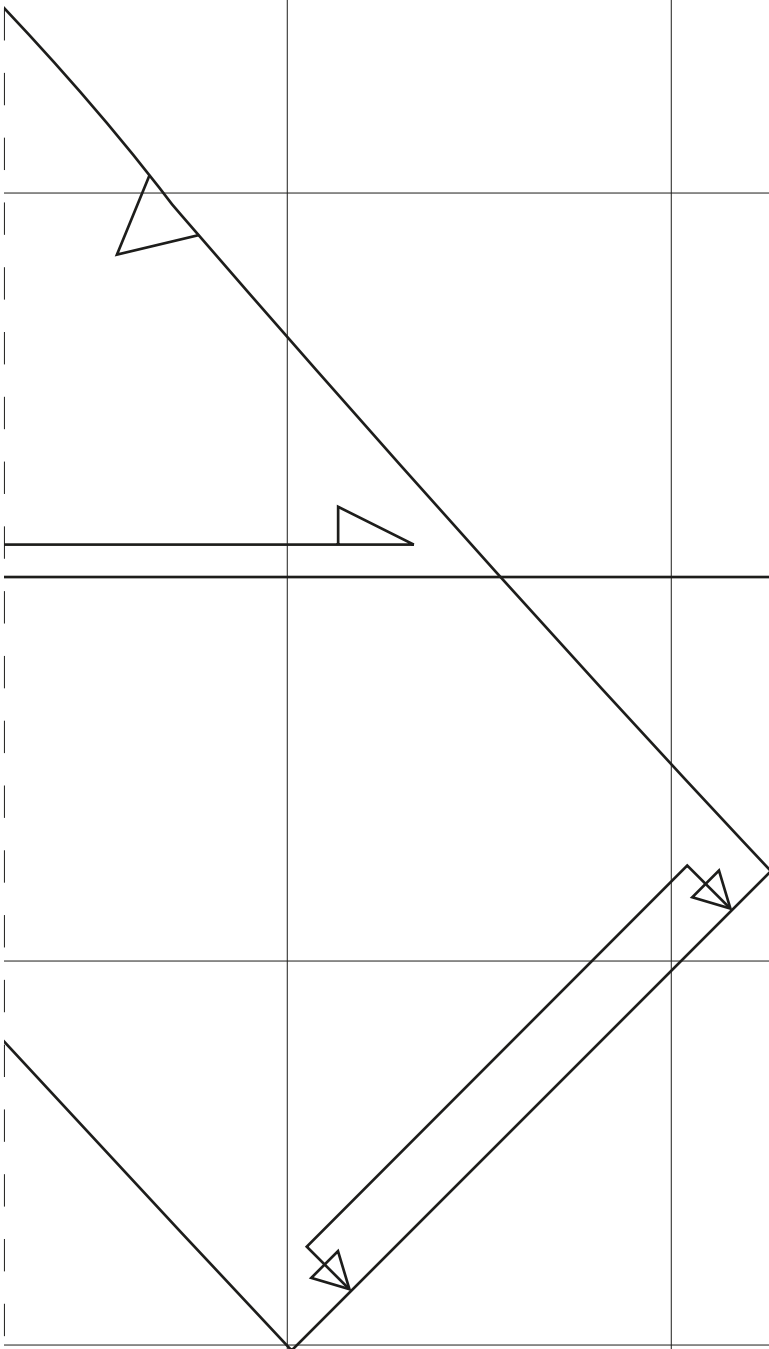

B1

B1

B1

B1



B2

B2

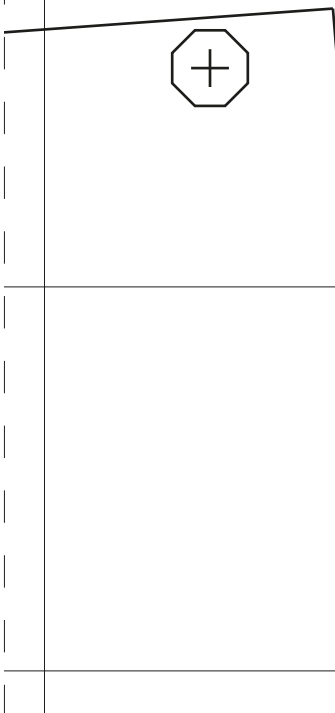
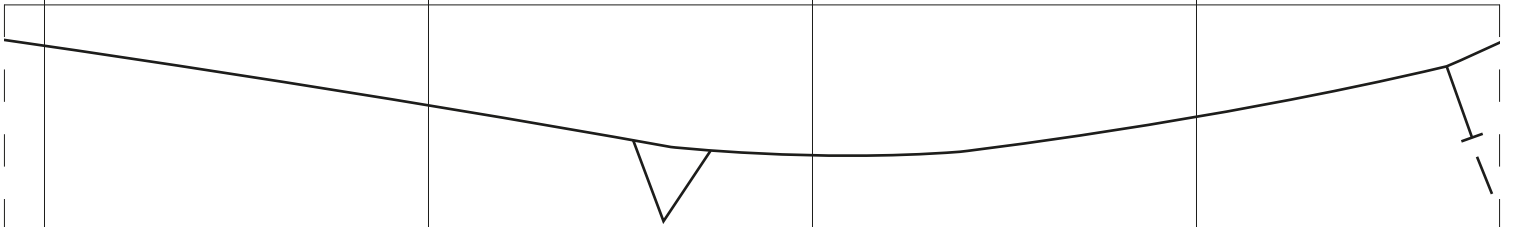

B2

B2

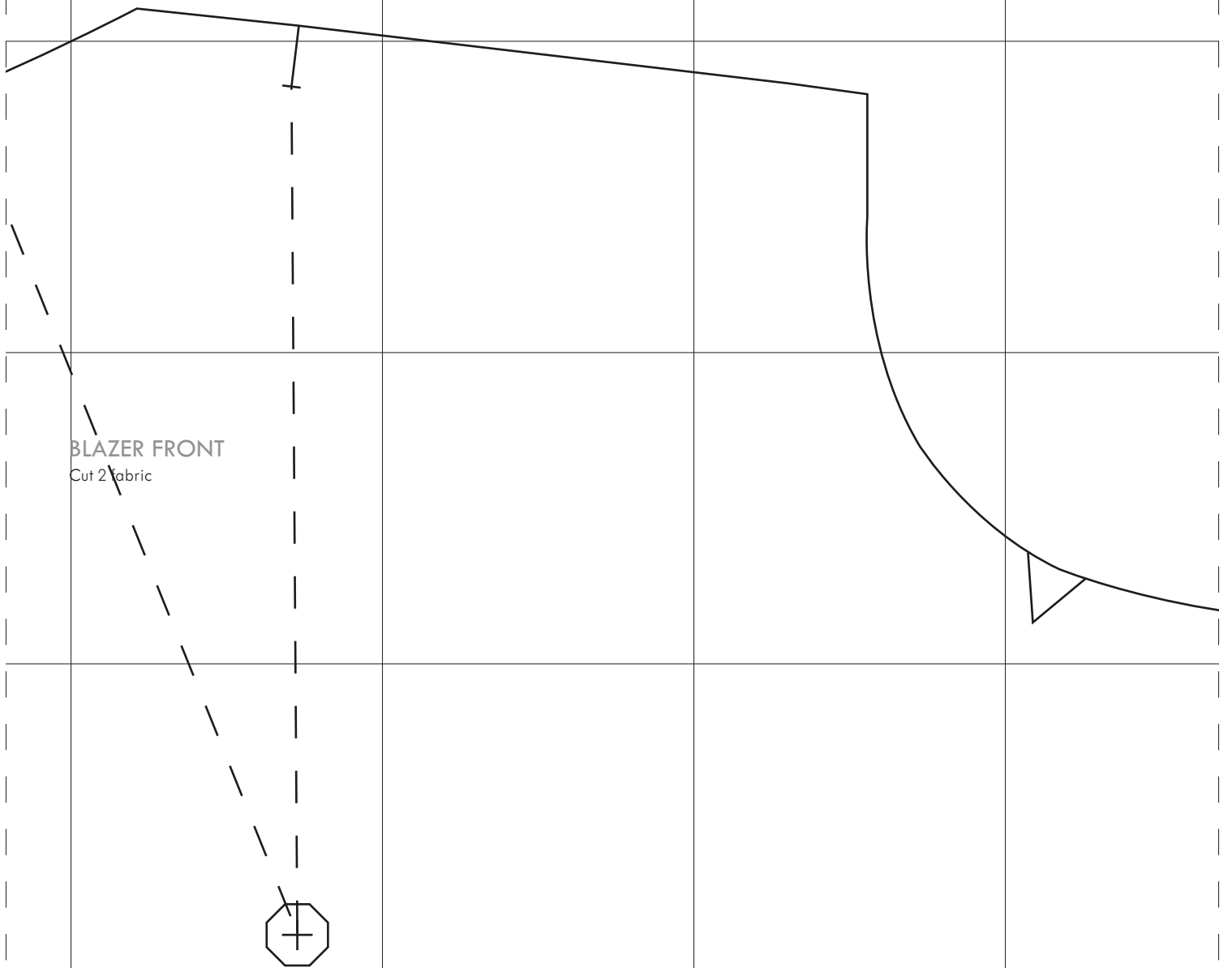

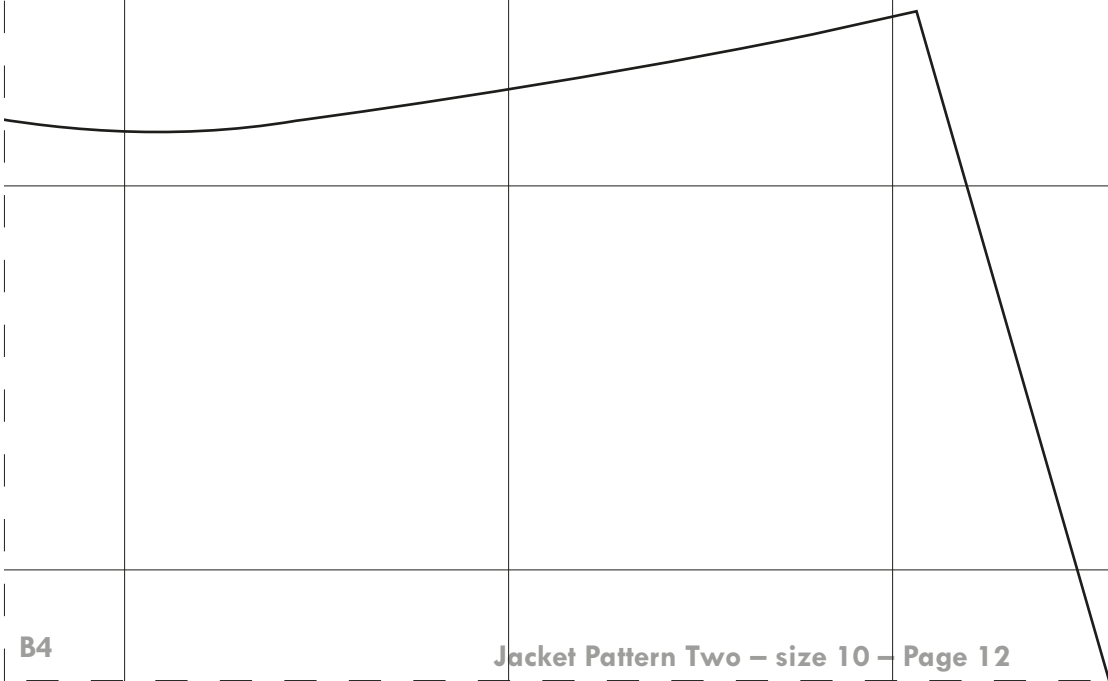

B5

B5



B5

B5

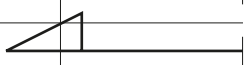

B6

B6

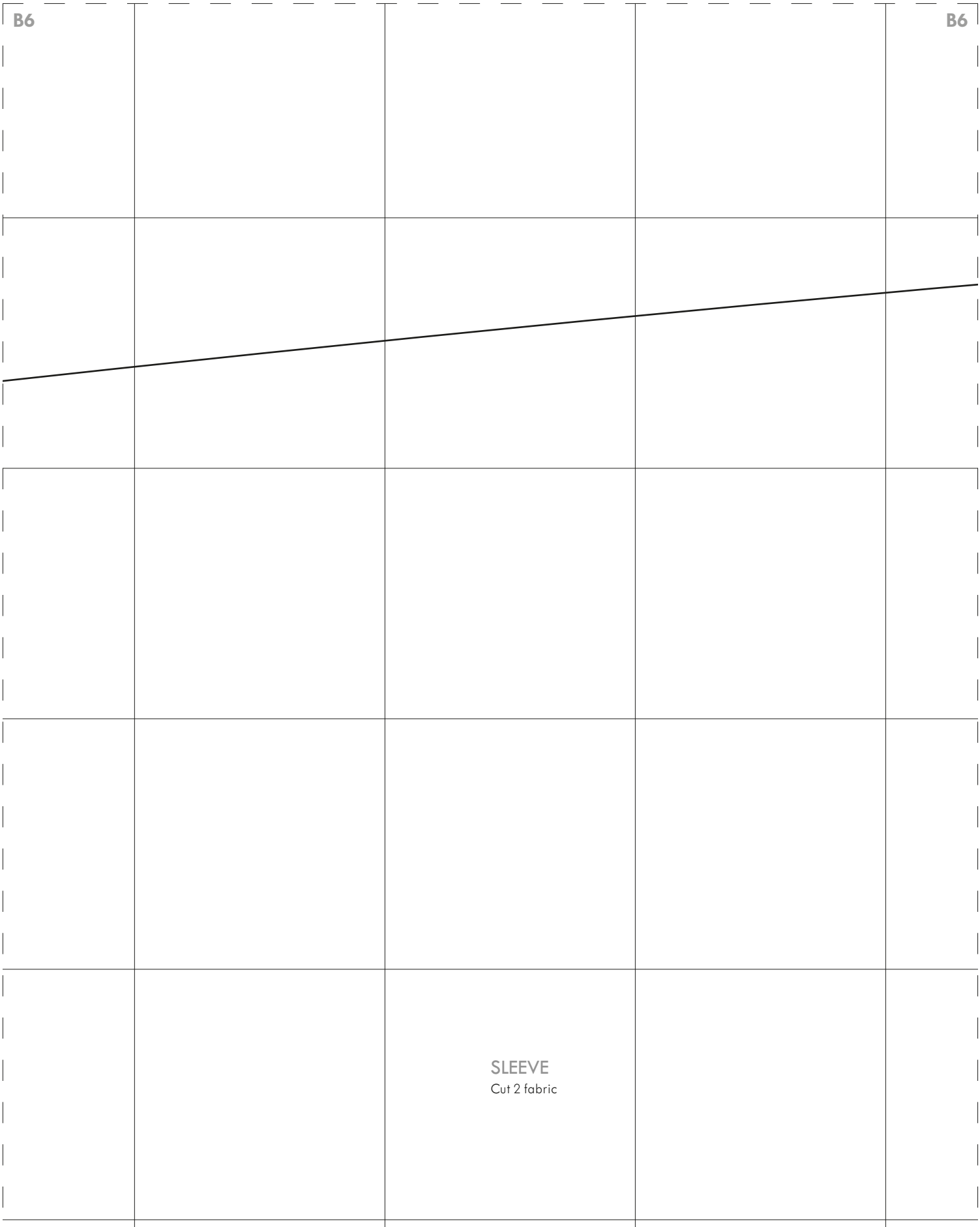

SLEEVE
Cut 2 fabric

B6

B6

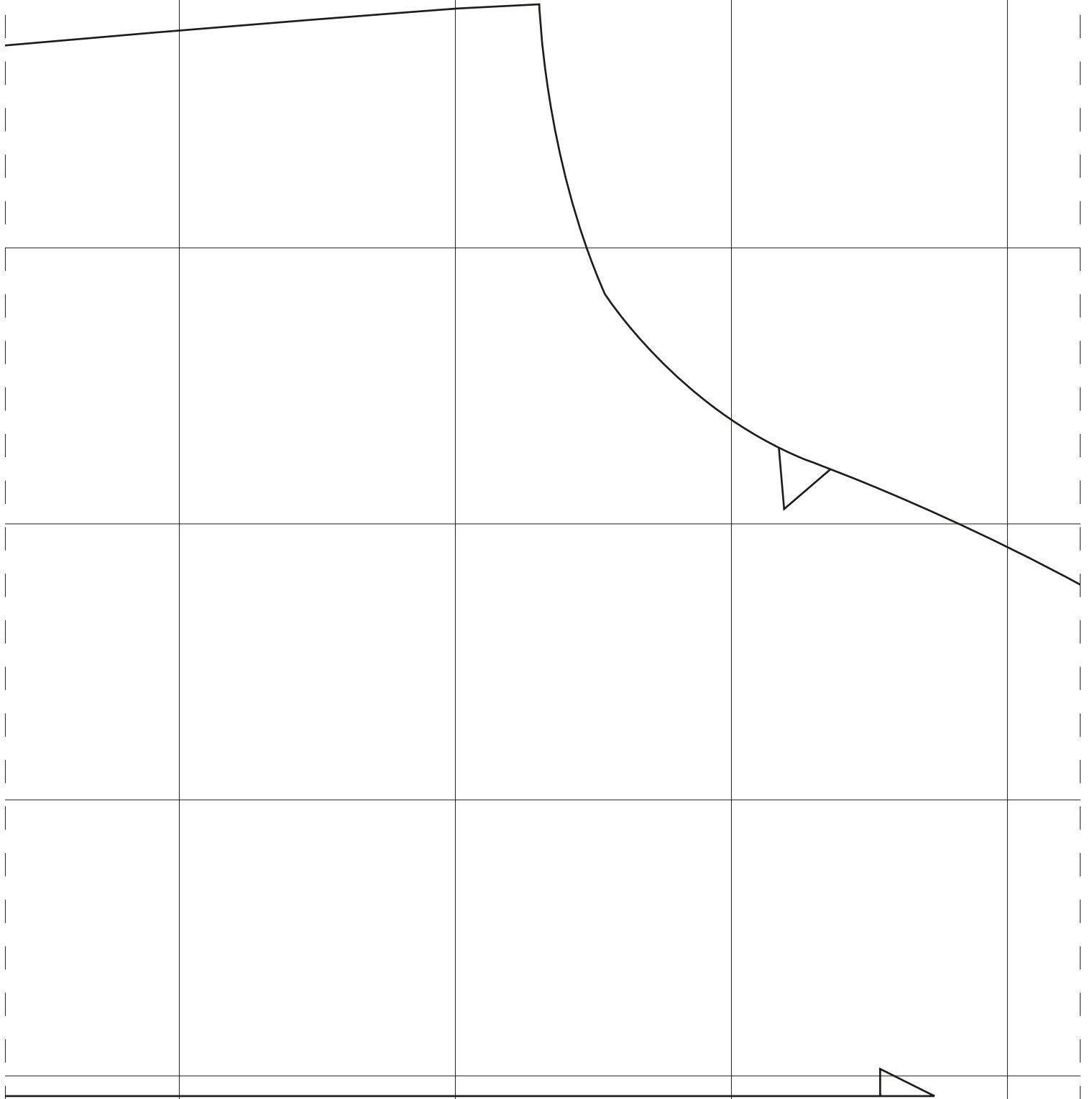

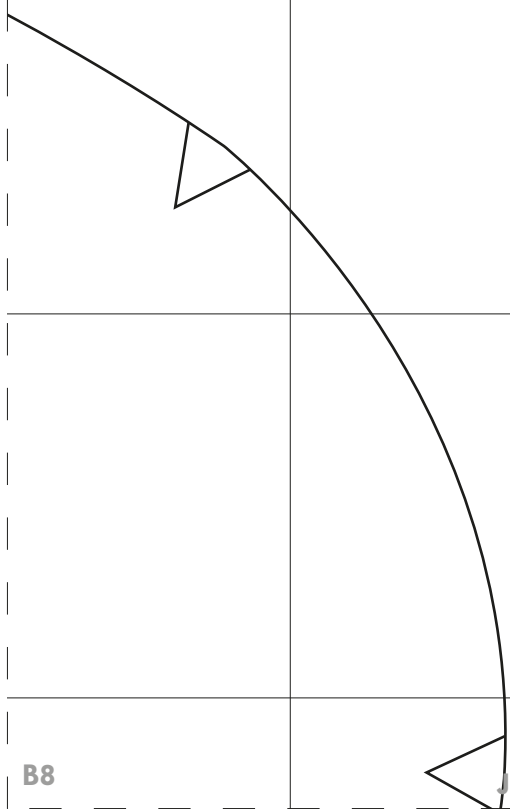

C1

C1



C1

C1

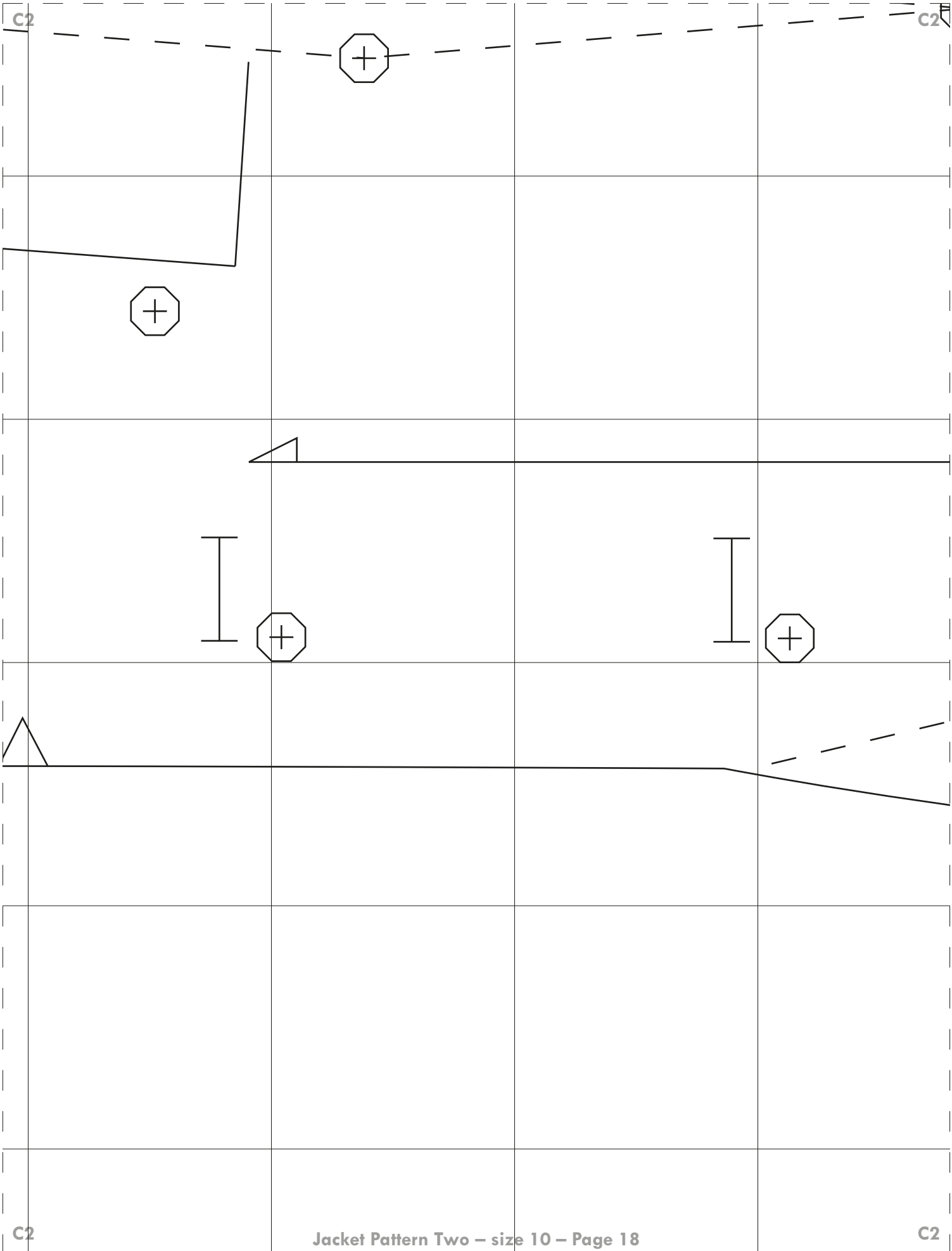

C2

C2

C2

C2

C3

C3

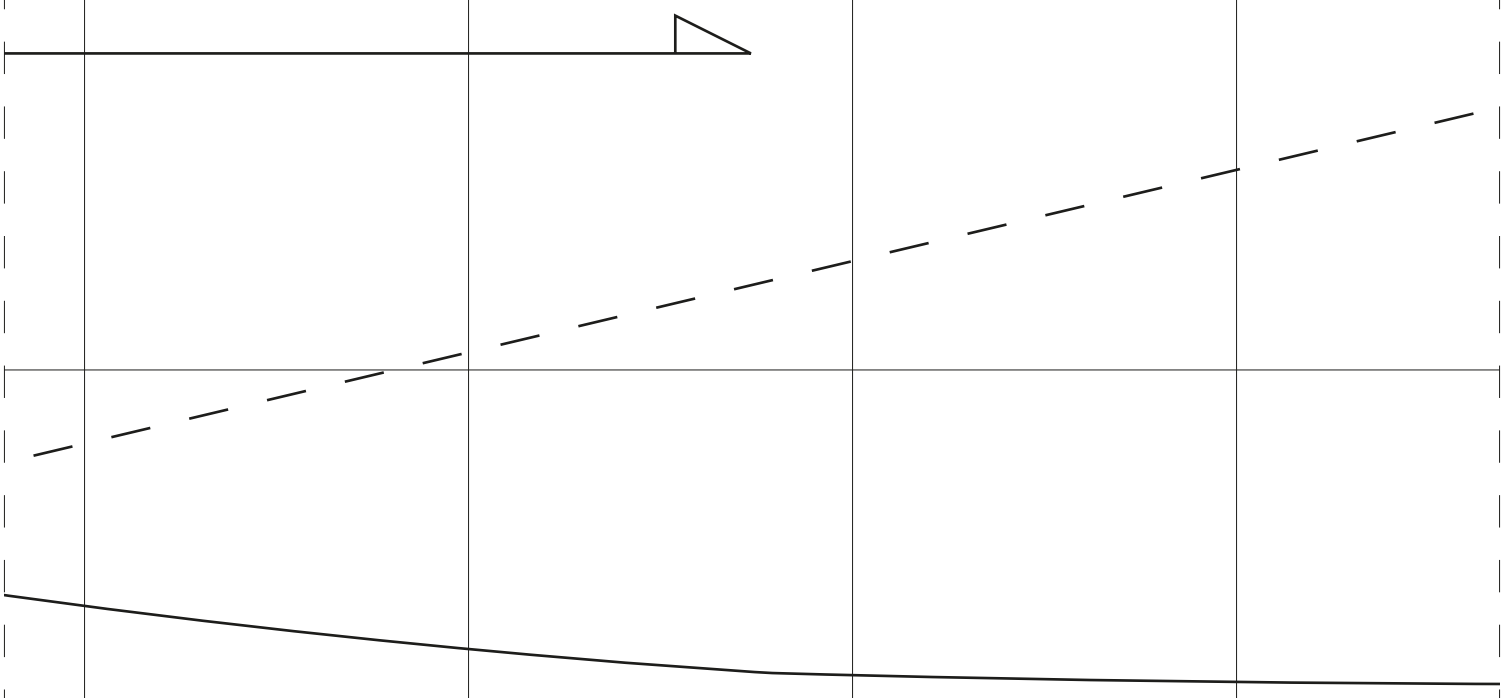

C3

C3

C4

C4

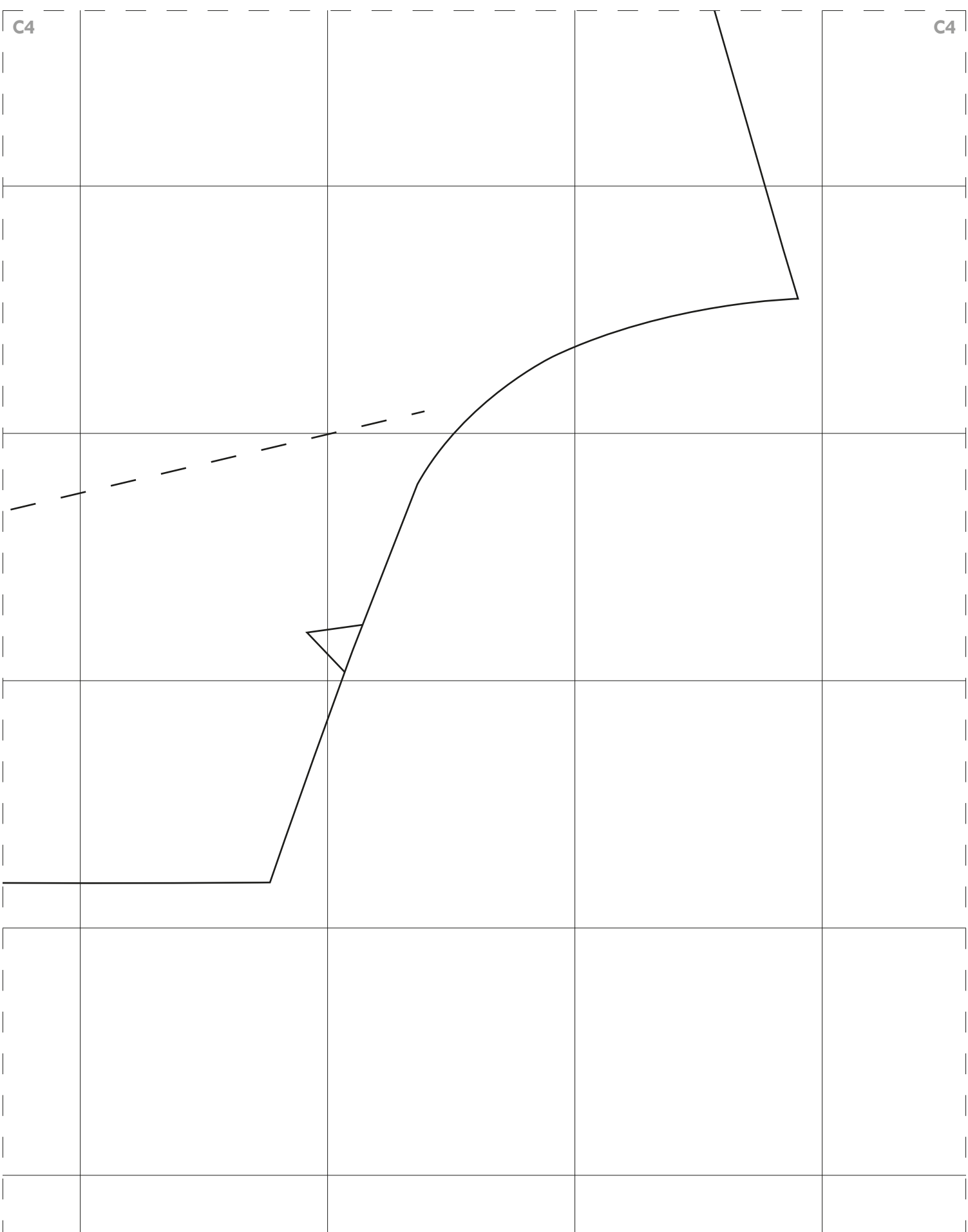

C4

C4

C5

C5



C5

C5

C6

C6

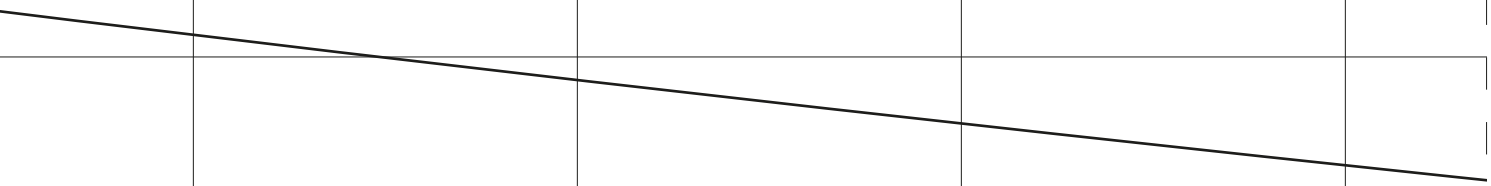

C6

C6

C7

C7

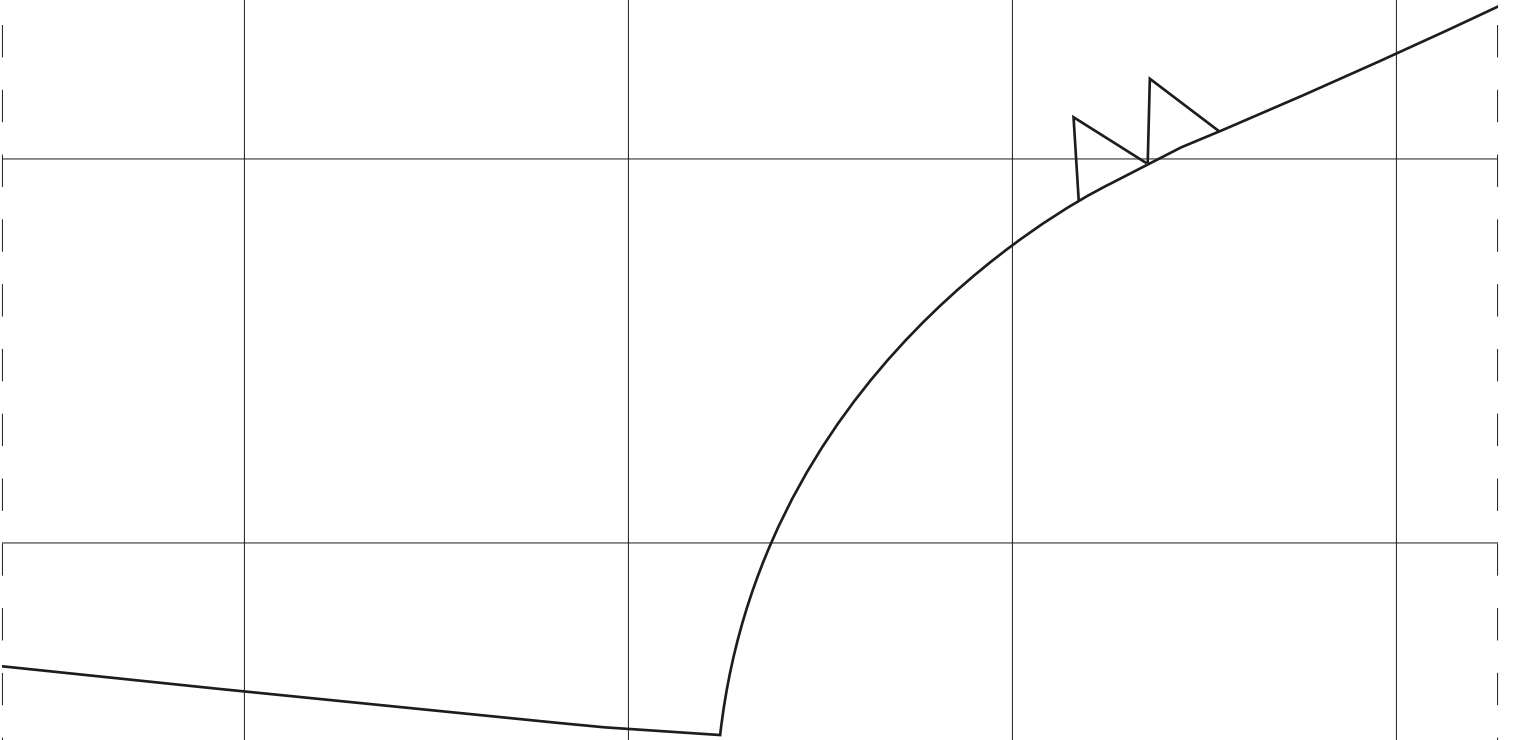
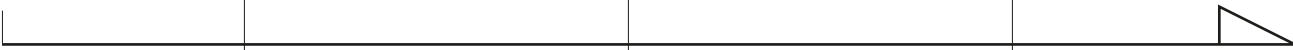

C7

C7

C8

C8

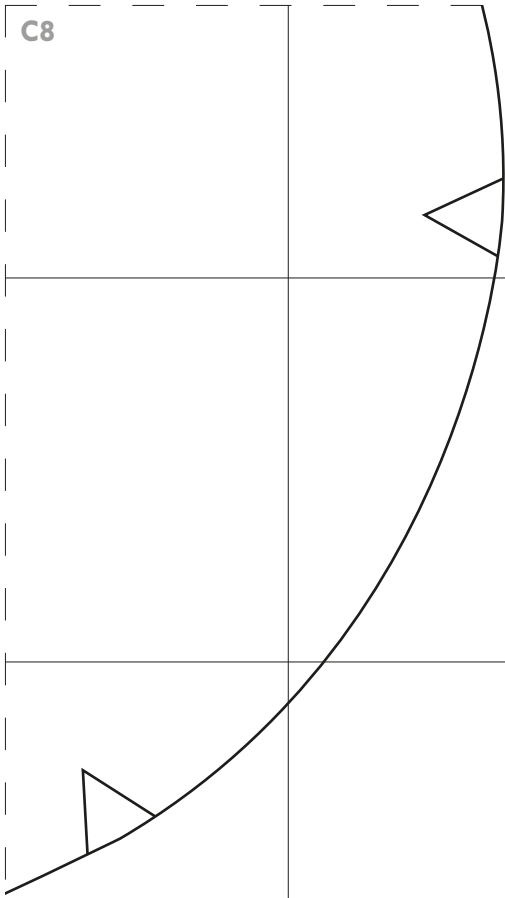

C8

C8

D1

D1

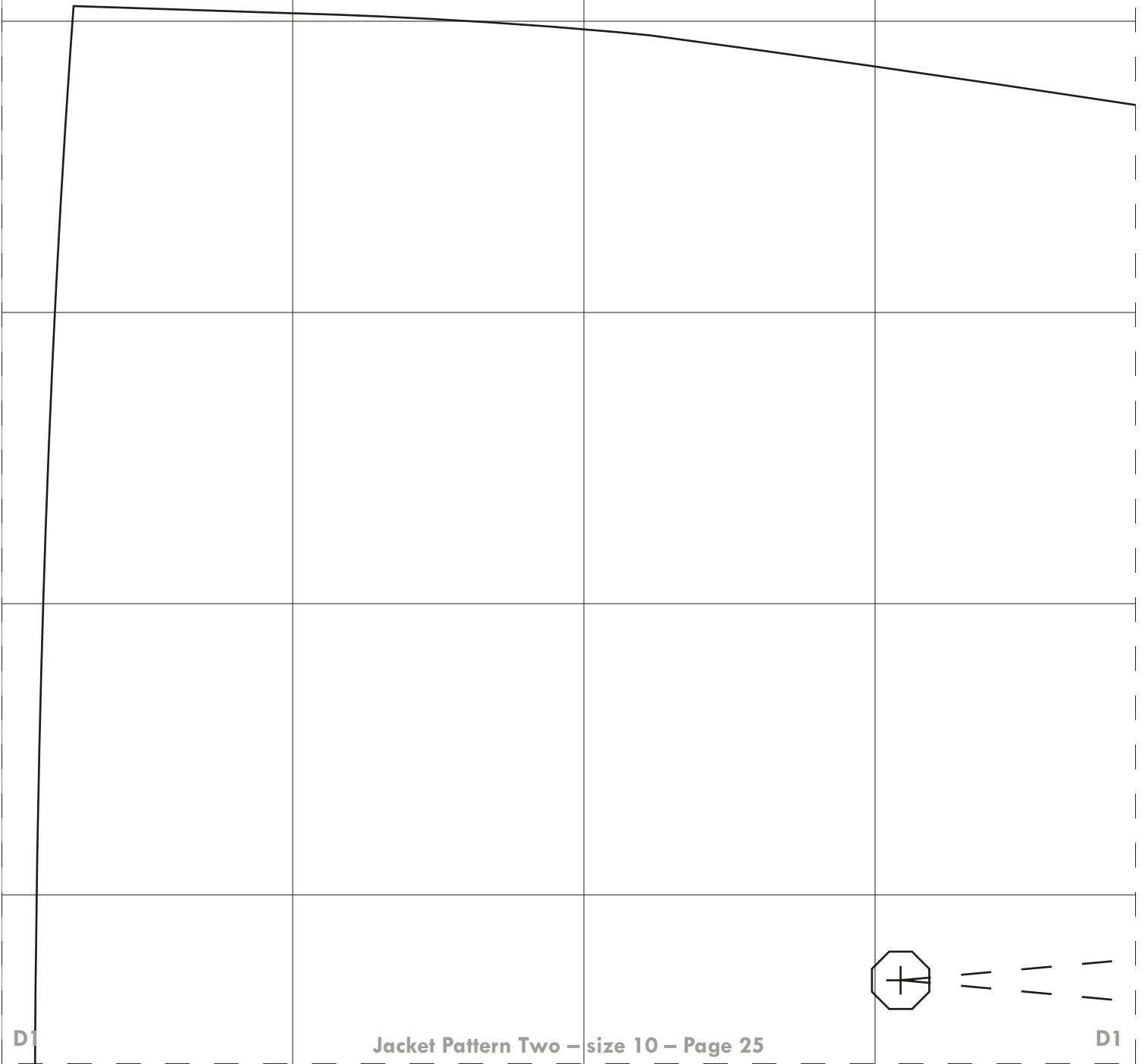

D1

D1

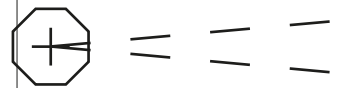

D2

D2

BLAZER BACK
Cut 2 fabric



D2

D2

D3

D3

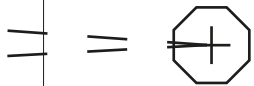
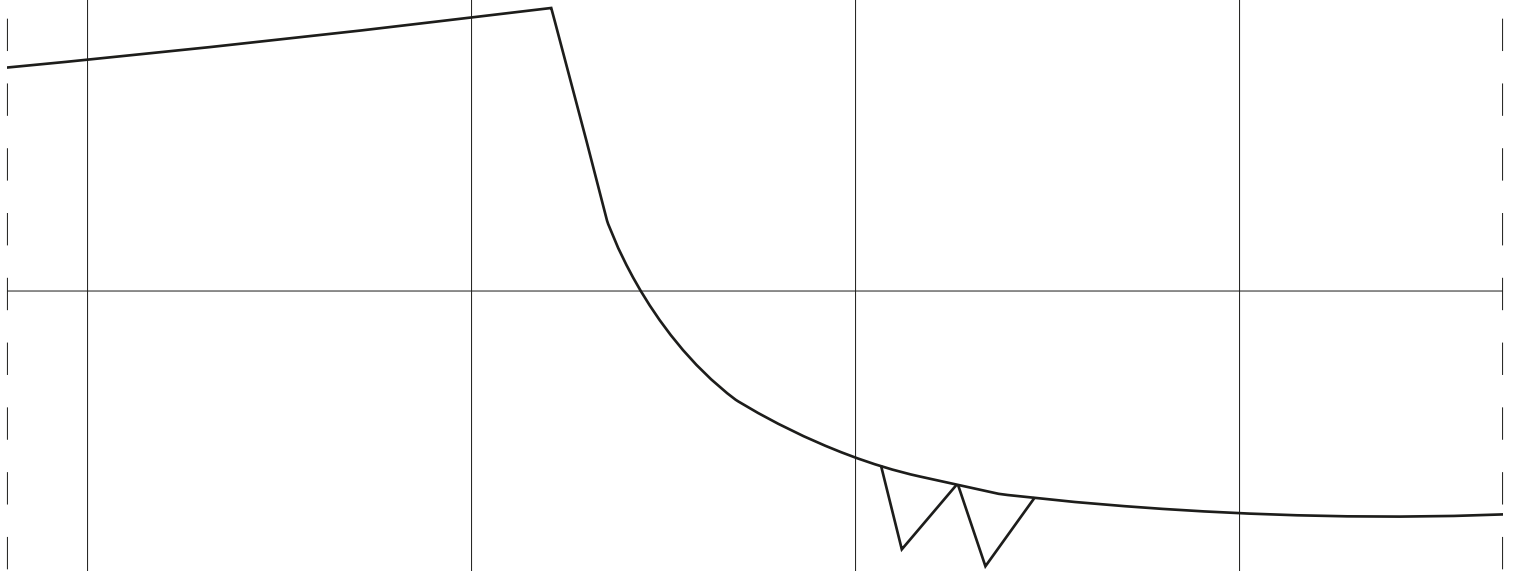

D3

D3

D4

D4

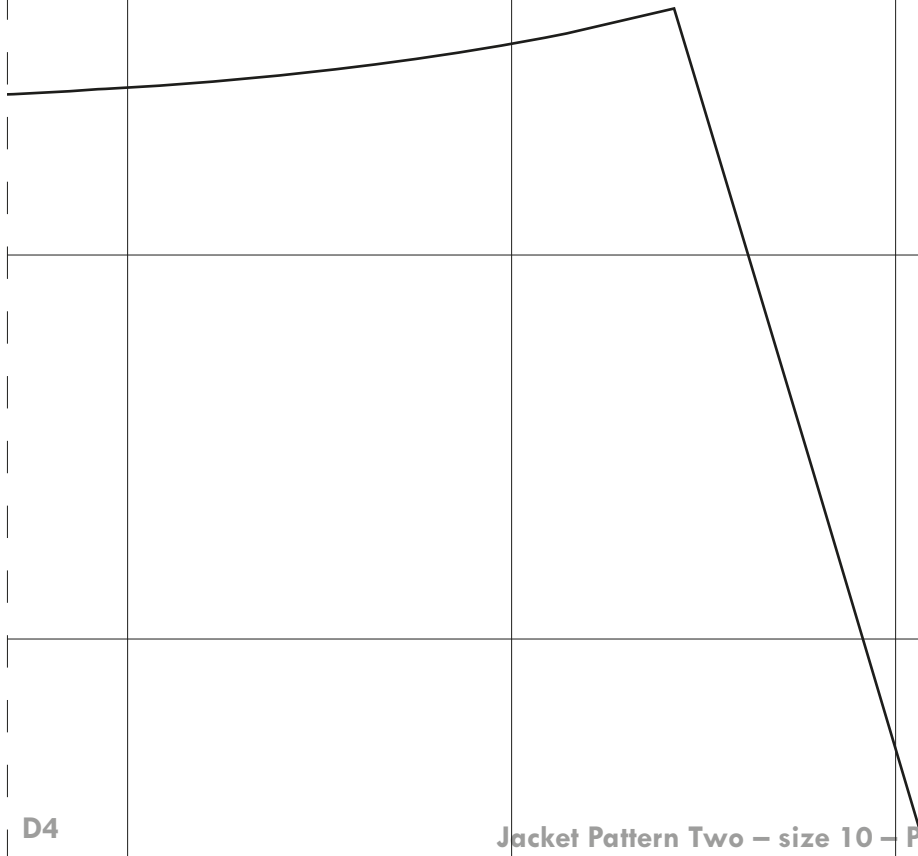

D4

D4

BACK NECK FACING

Cut 1 on fold of fabric
Cut 1 on fold of interfacing

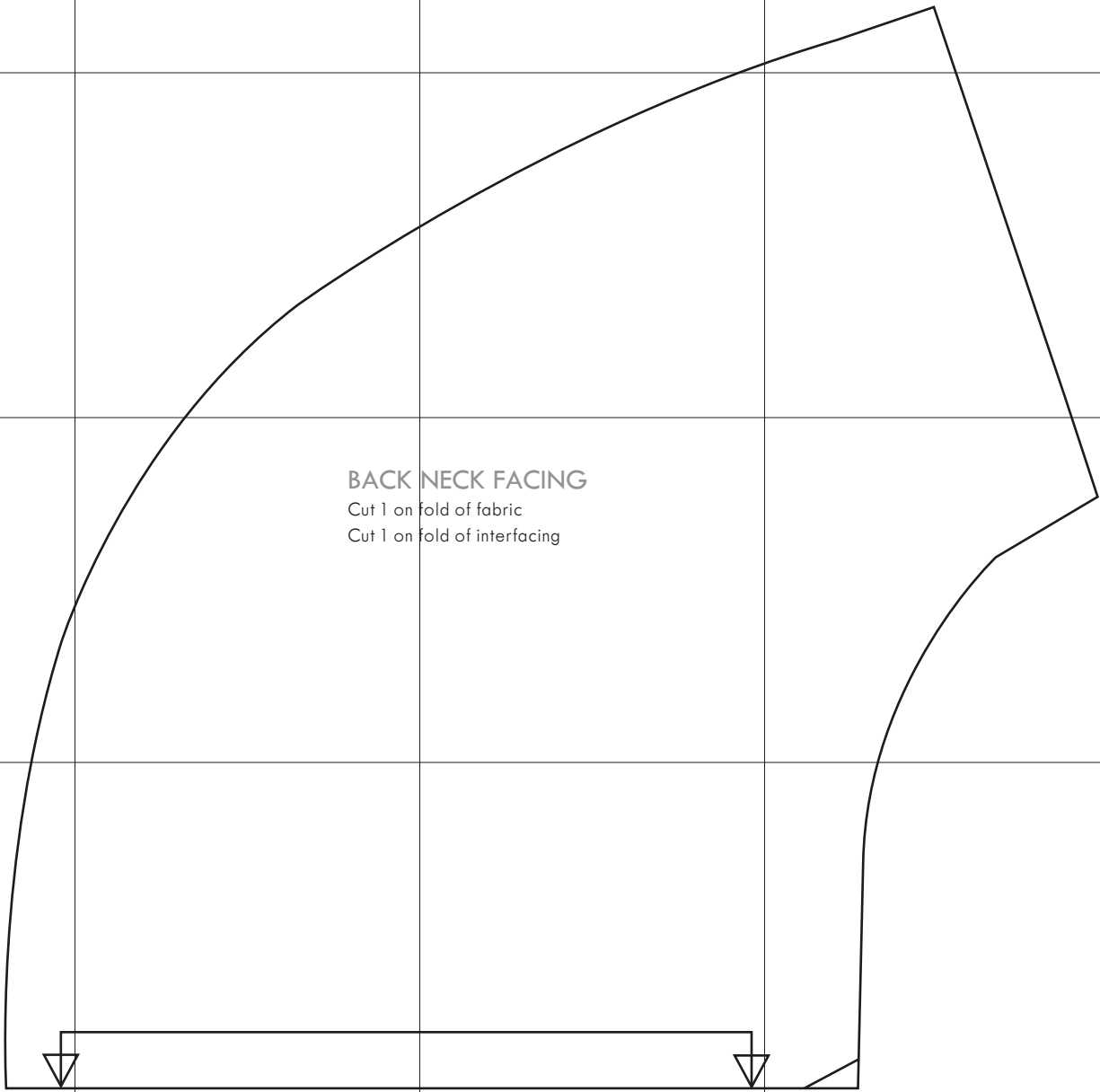

E1

E1

E1

E1

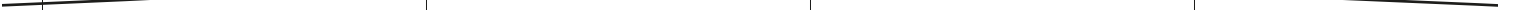

E3

E3

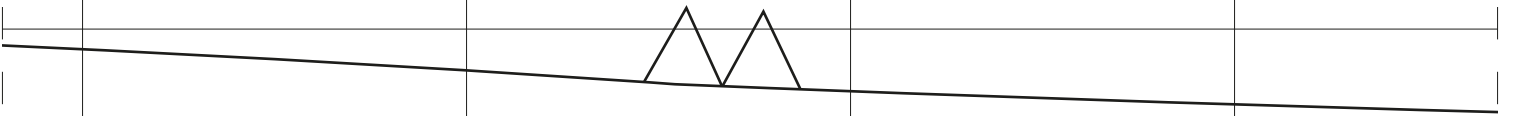

E3

E3

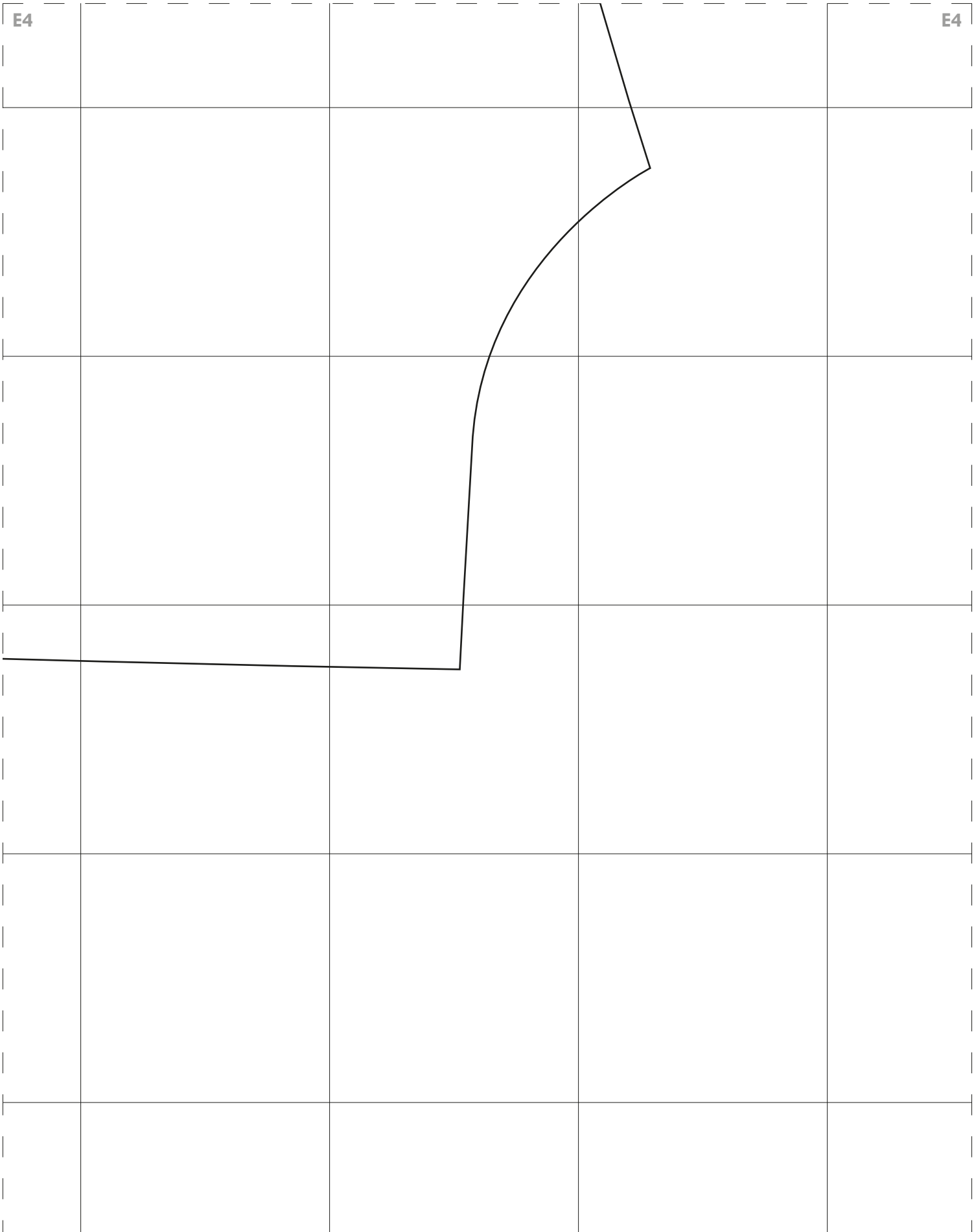

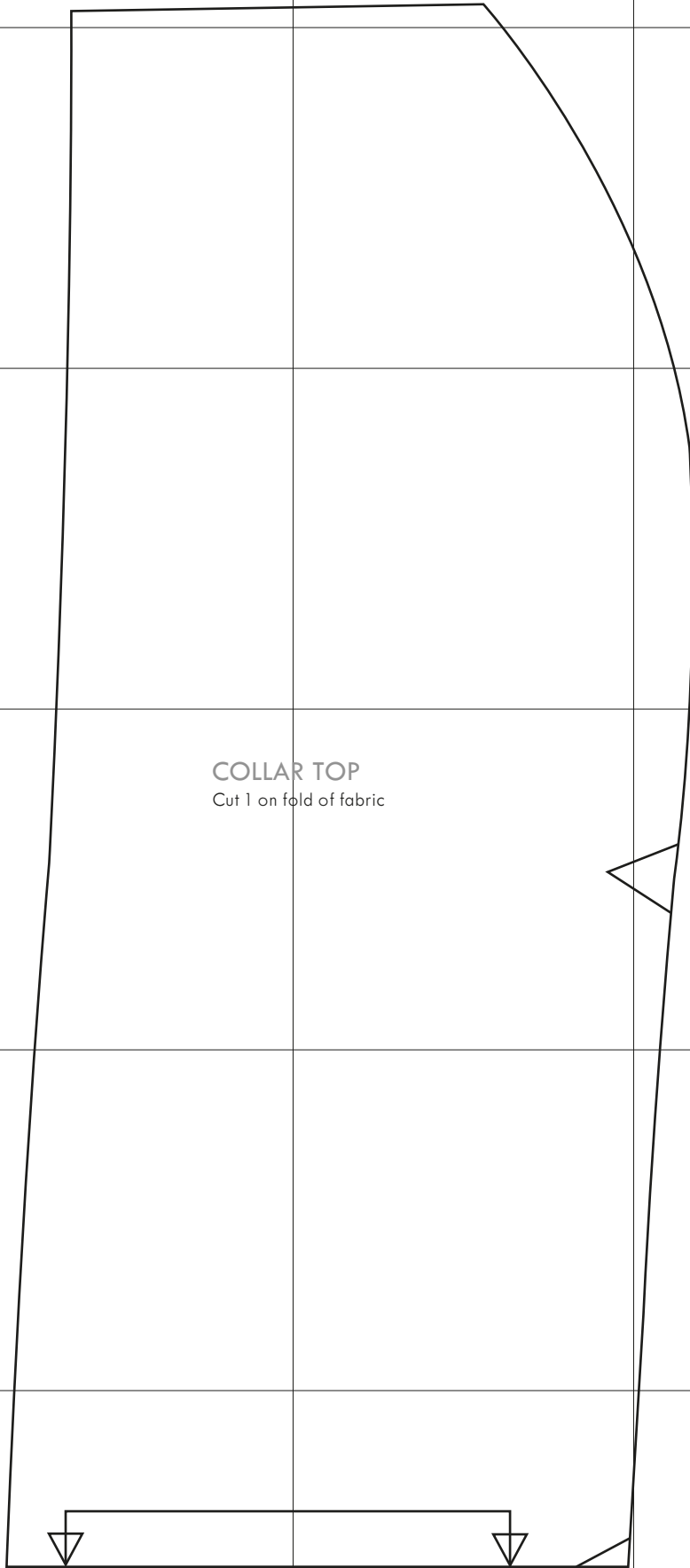

COLLAR TOP
Cut 1 on fold of fabric