

A1

A1

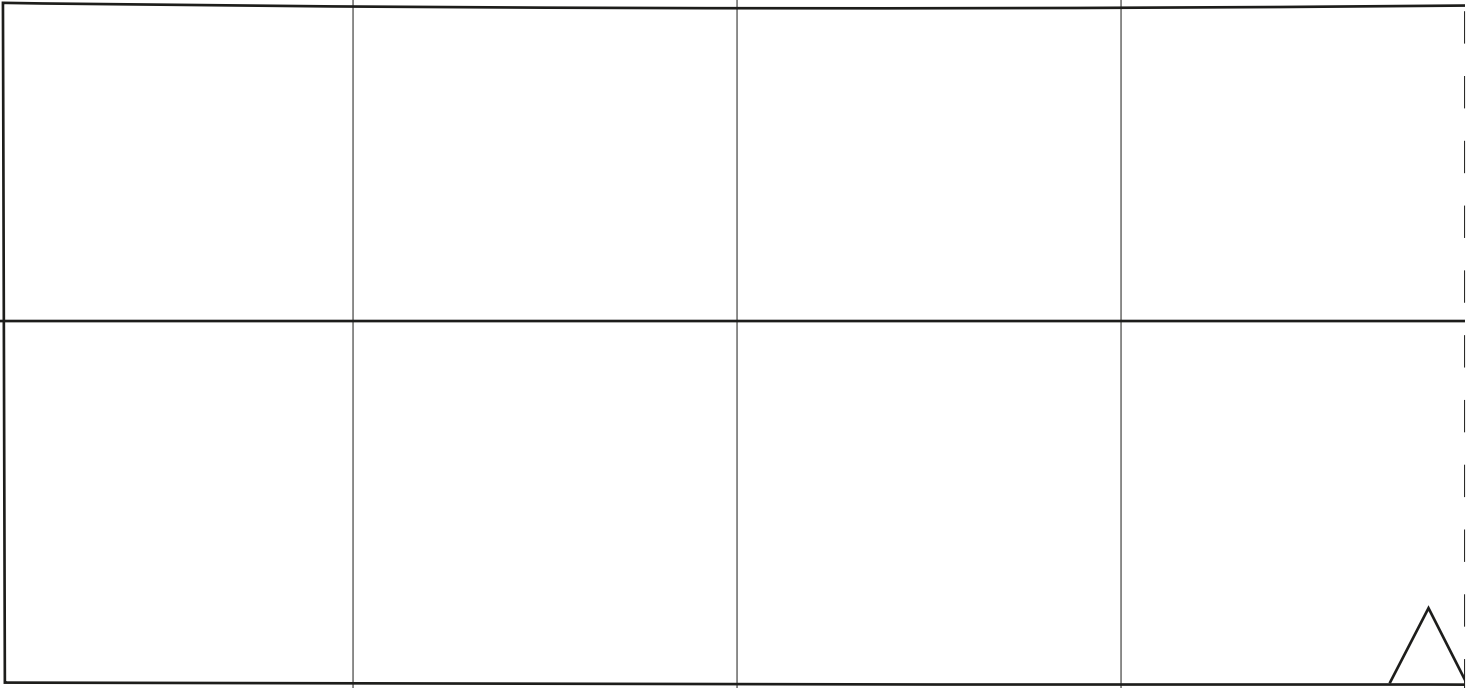

A1

A1

A2

A2



A2

A2

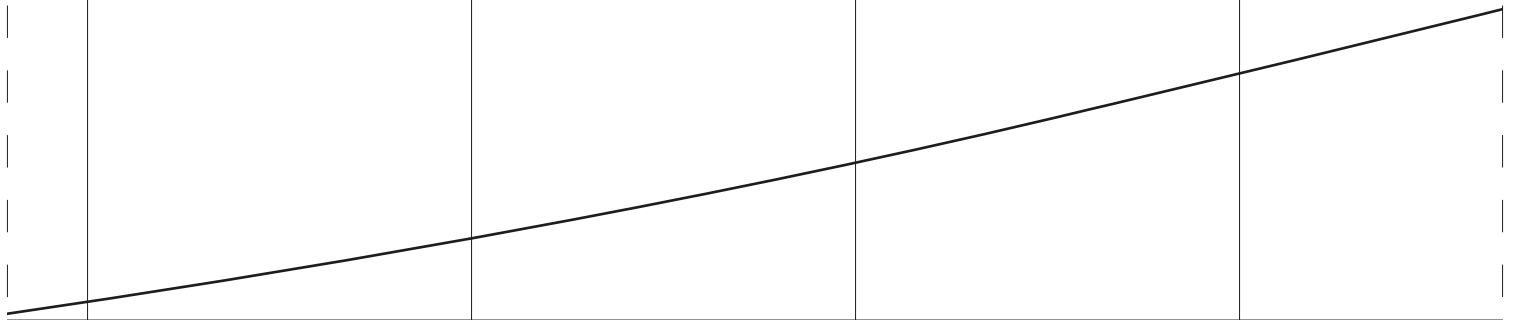

FRONT FACING  
Cut 2 fabric



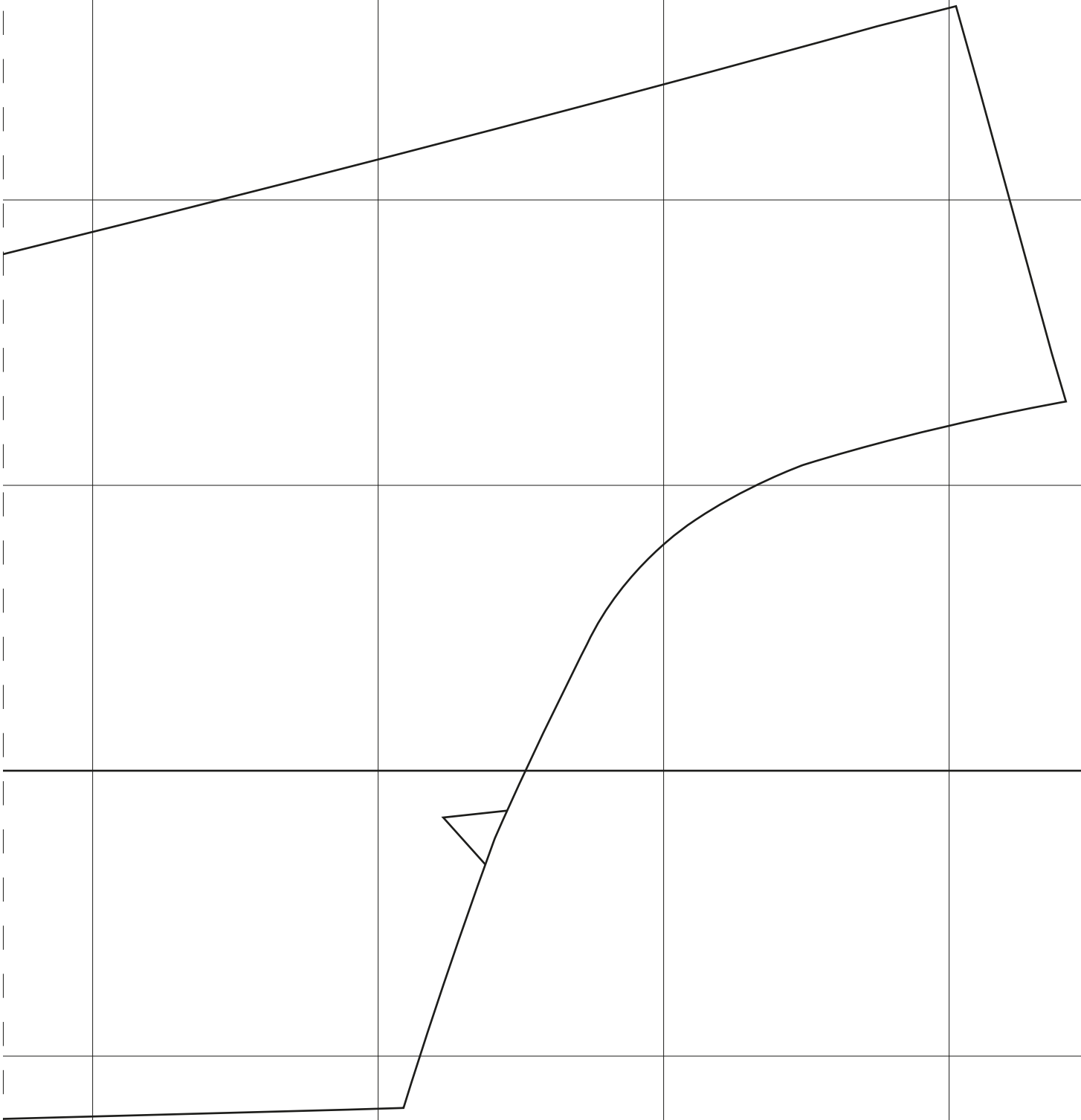

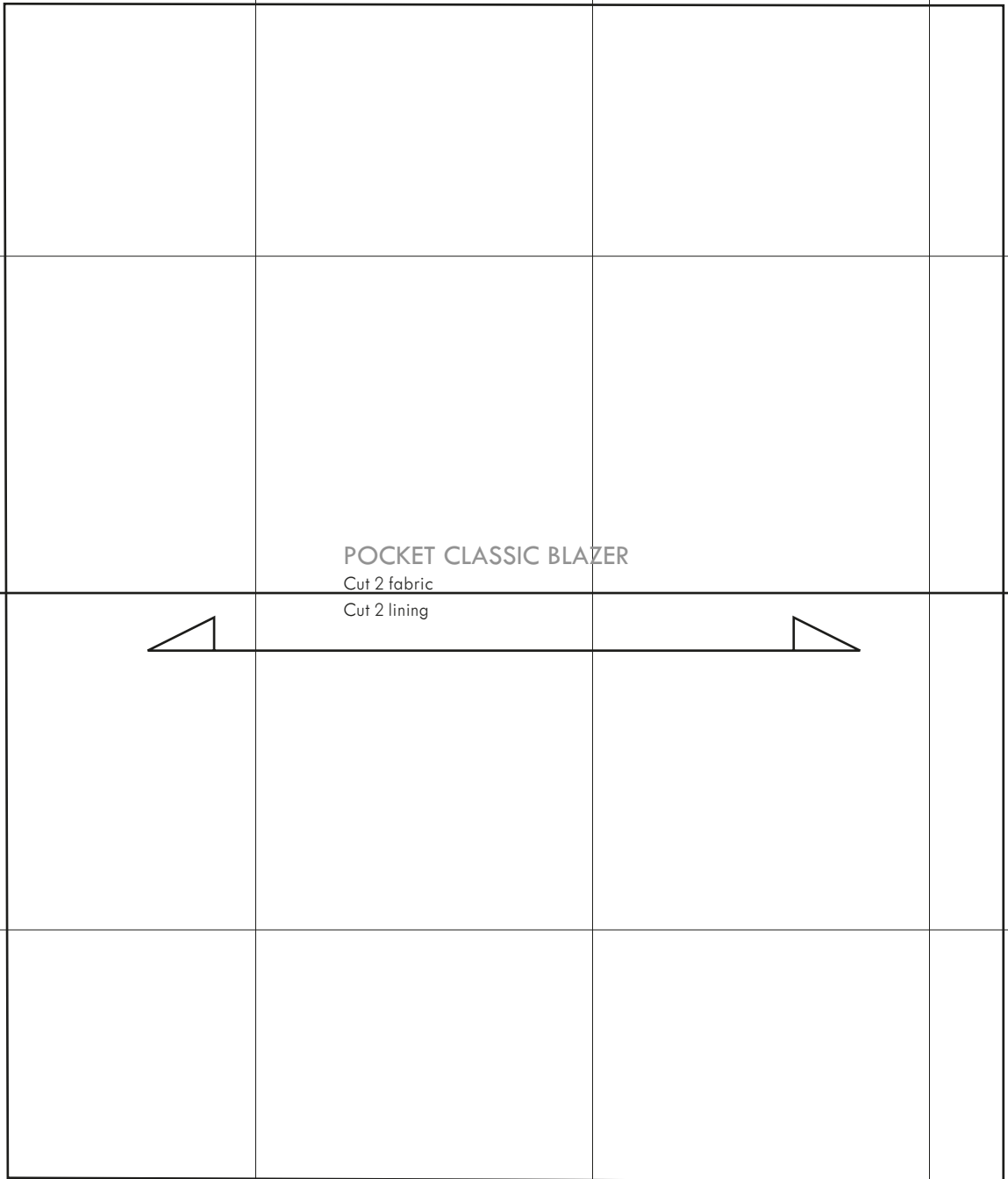

POCKET CLASSIC BLAZER

Cut 2 fabric

Cut 2 lining

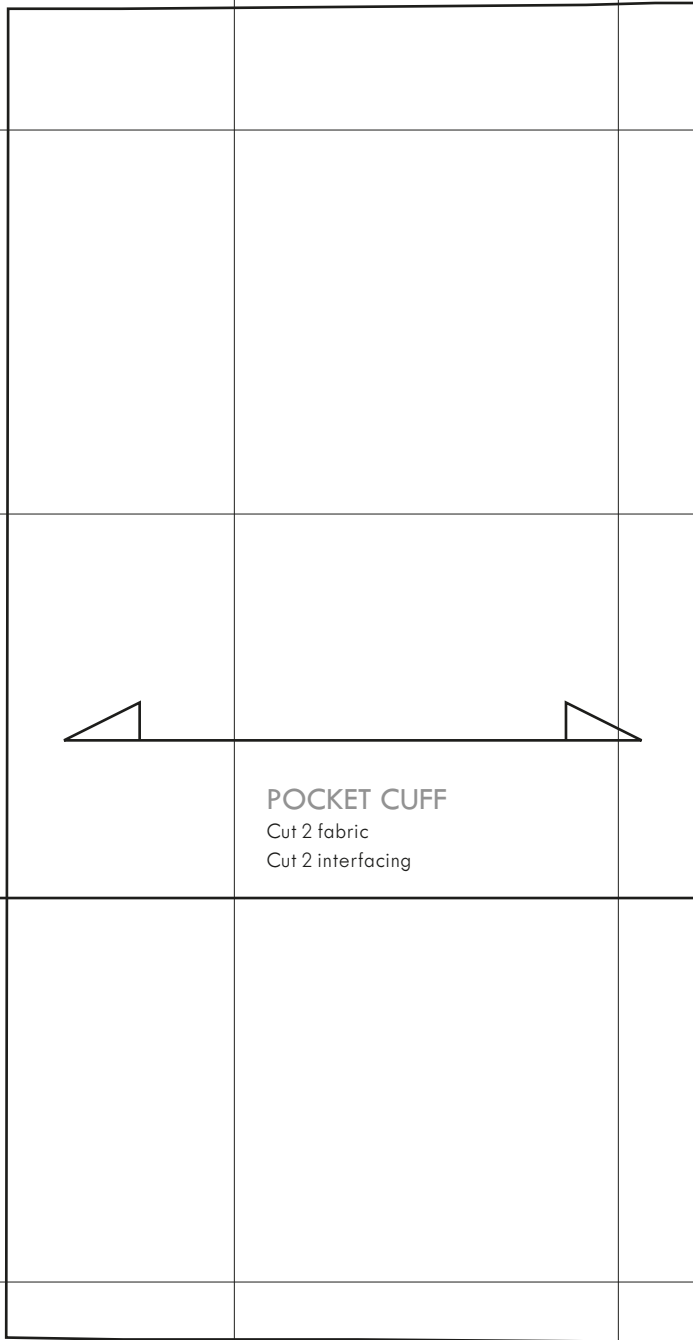

POCKET CUFF  
Cut 2 fabric  
Cut 2 interfacing

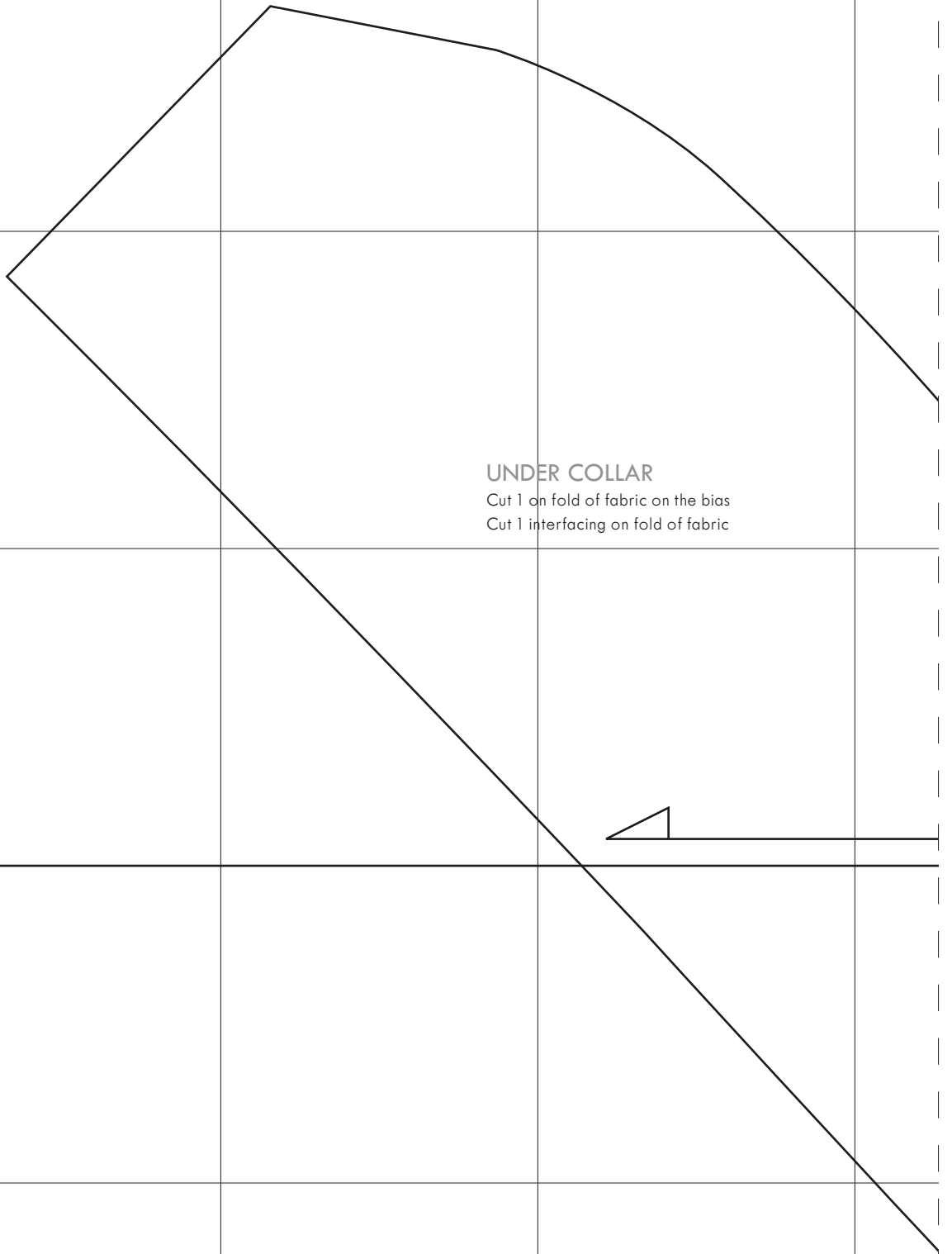

UNDER COLLAR

Cut 1 on fold of fabric on the bias  
Cut 1 interfacing on fold of fabric

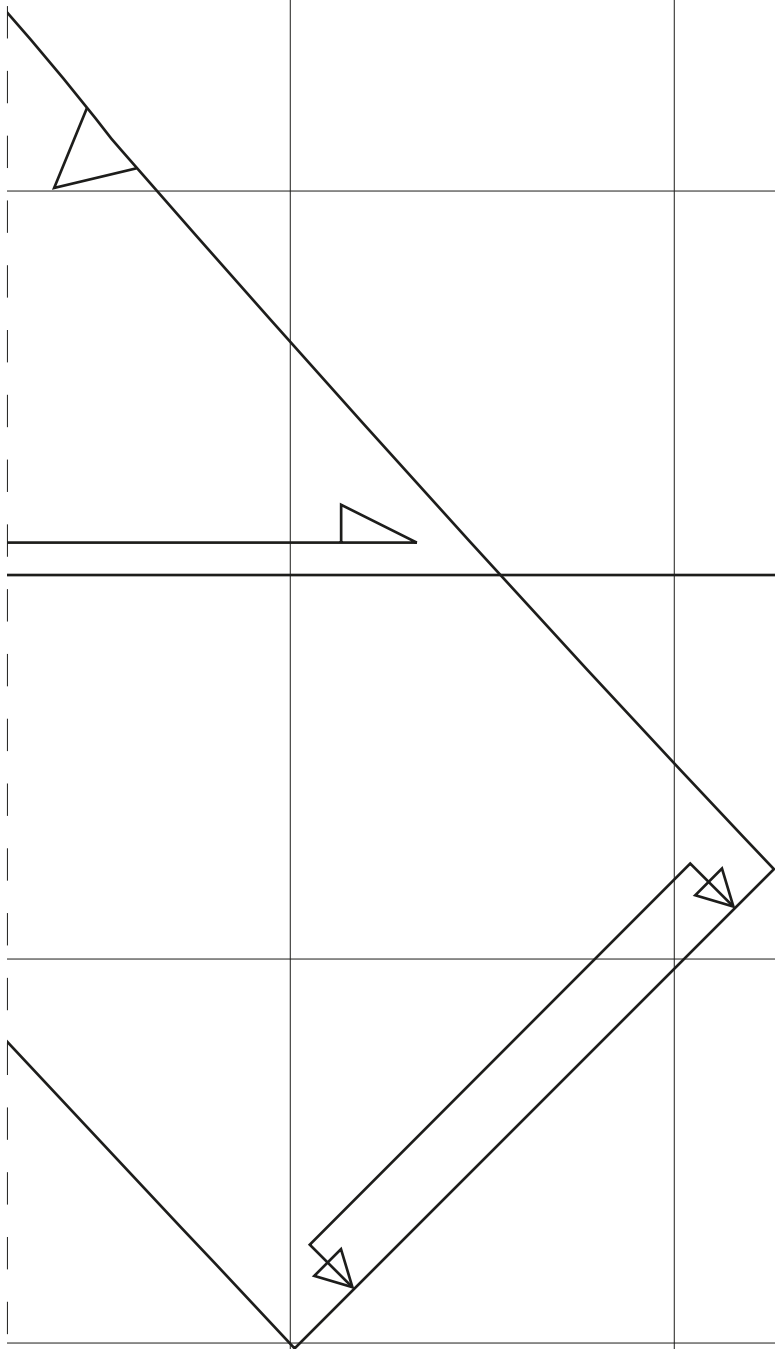



B1

B1

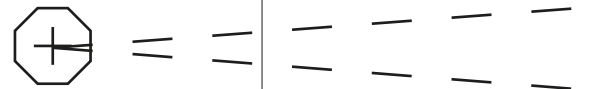
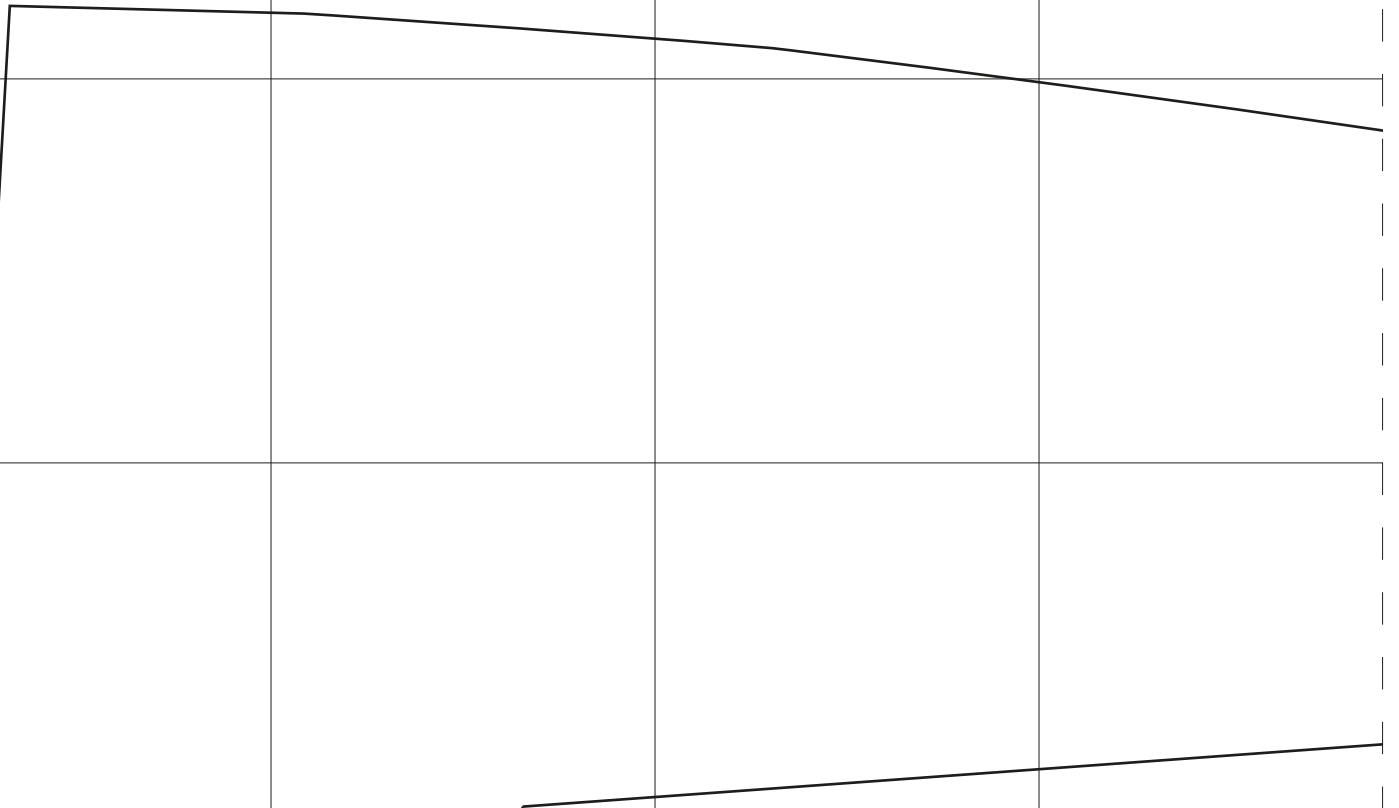

B1

B1

B2

B2

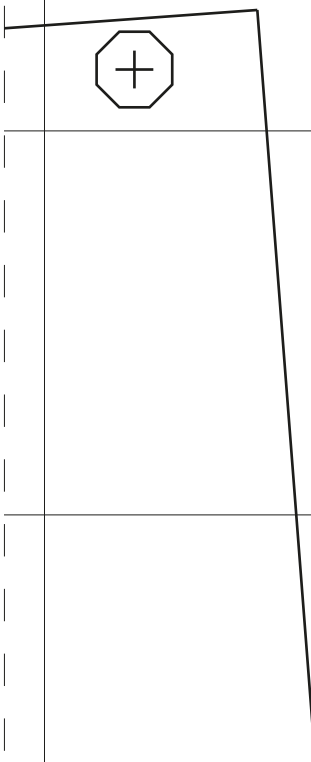
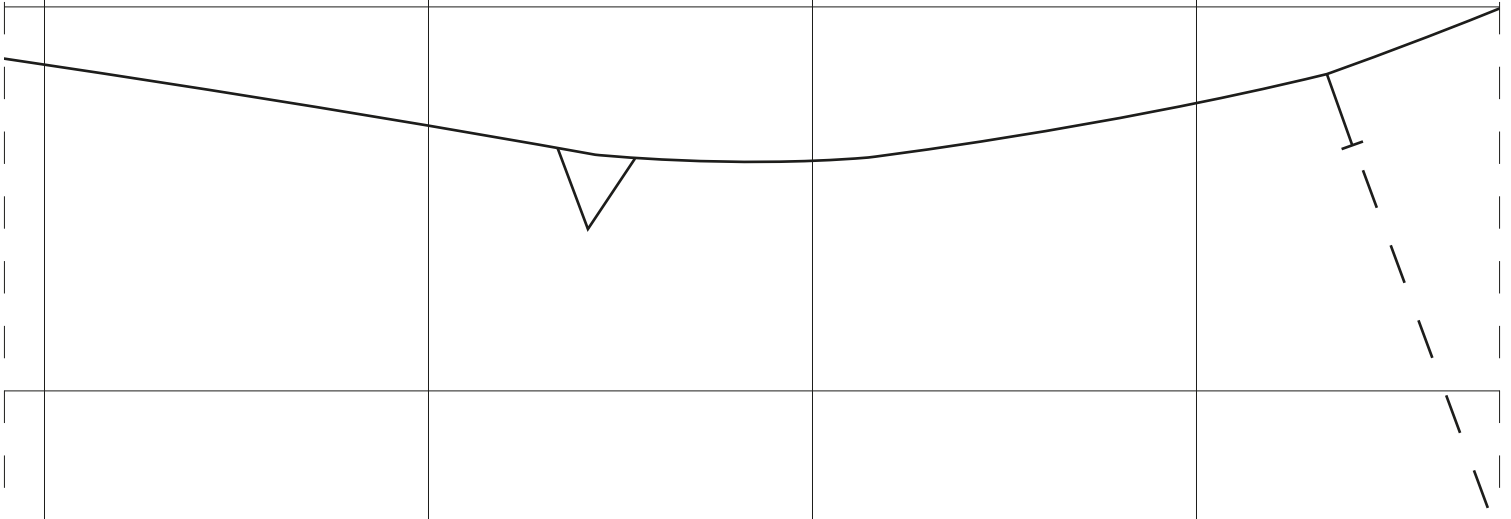

BLAZER FRONT  
Cut 2 fabric

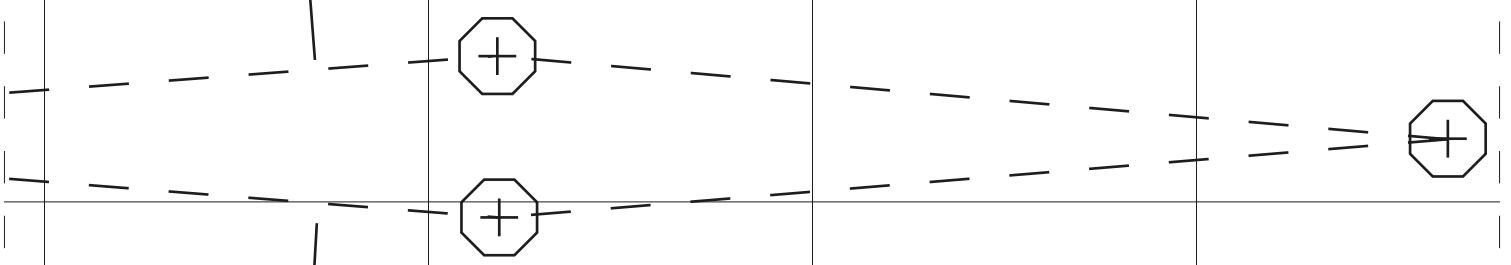

B2

B2

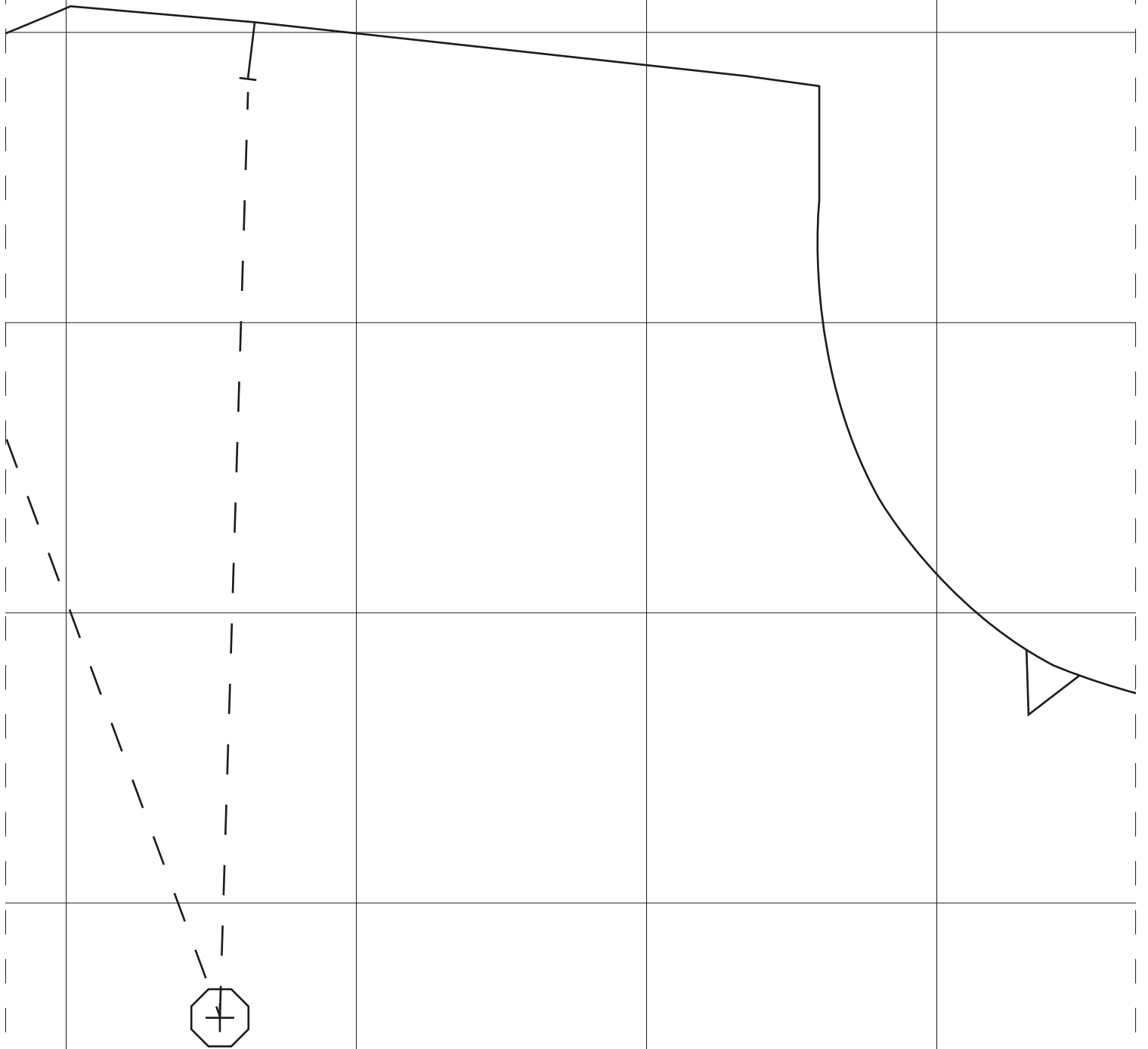

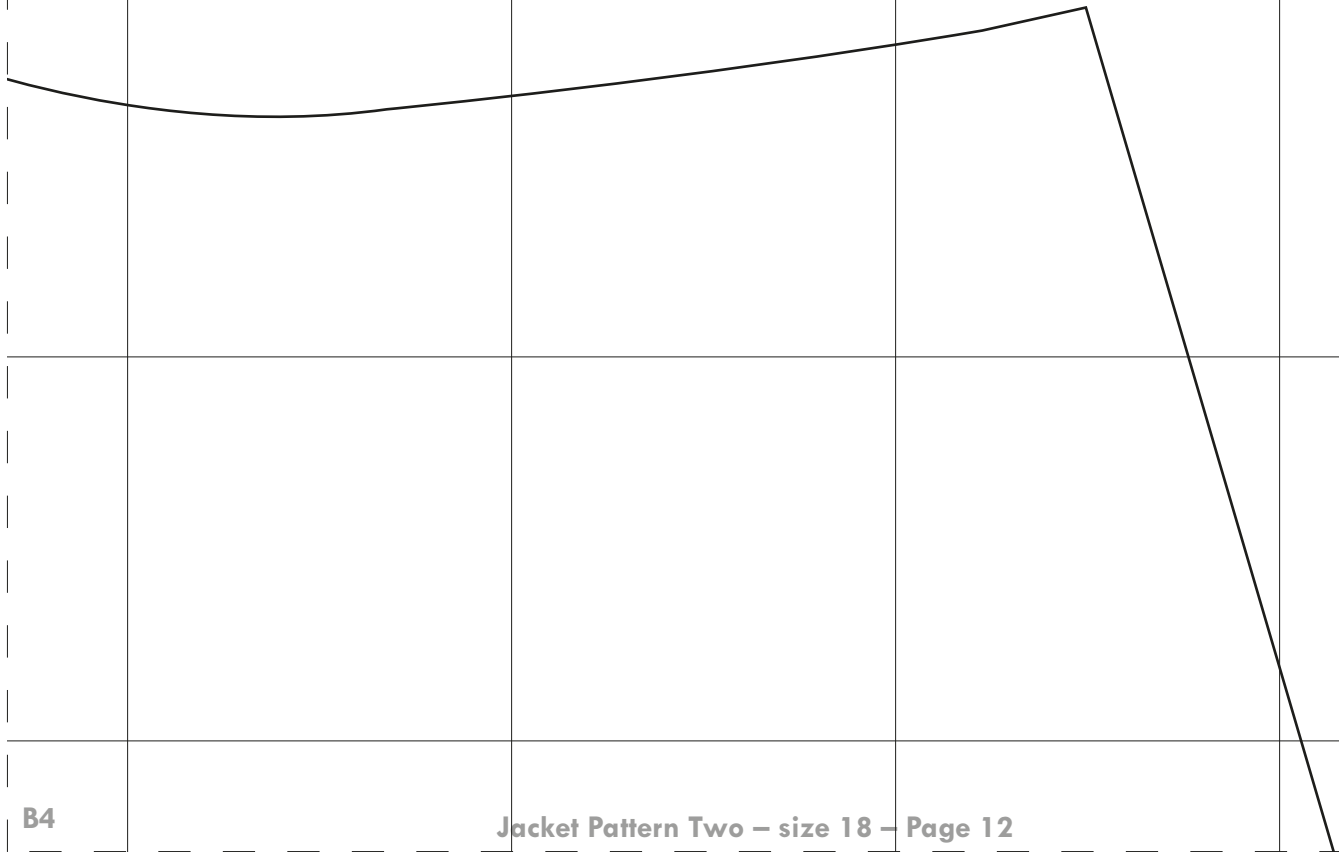

B5

B5

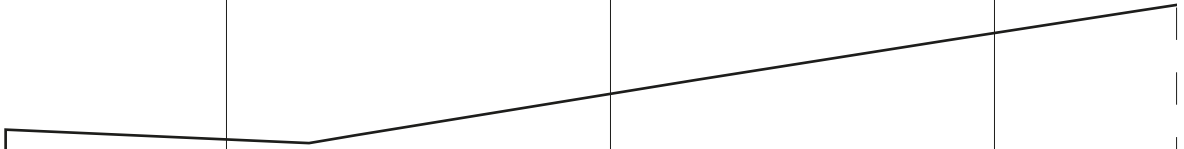

B5

B5

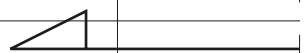

B6

B6

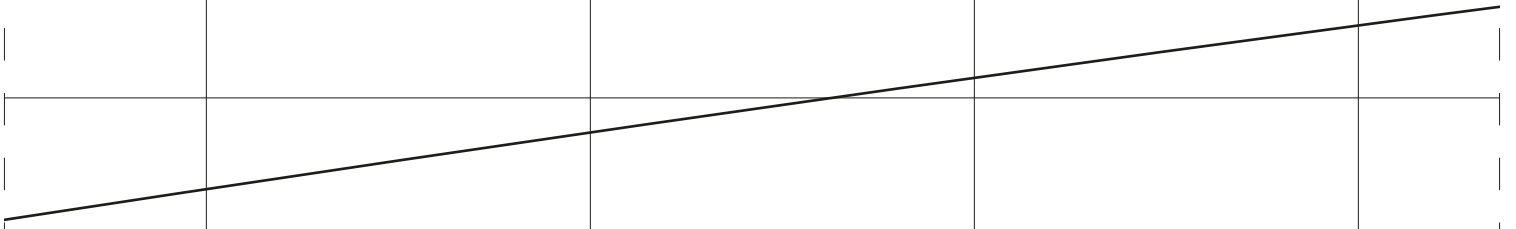

SLEEVE  
Cut 2 fabric

B6

B6

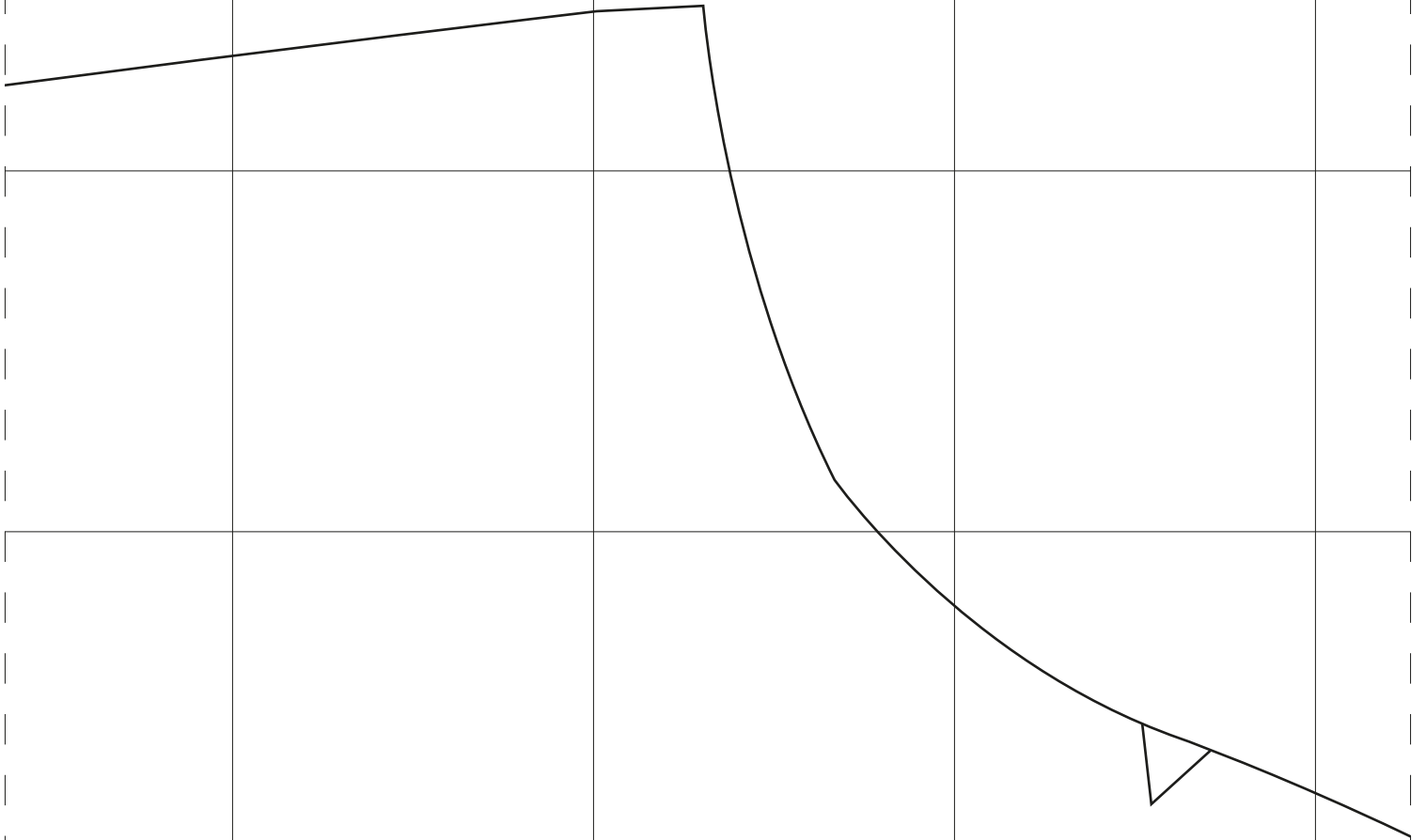

B8

B8

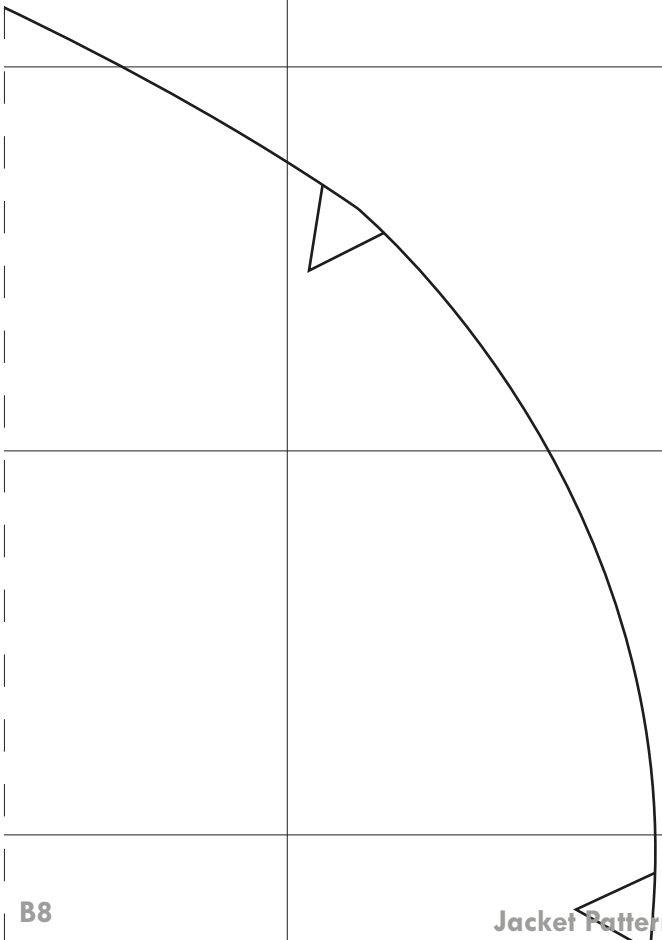

B8

B8



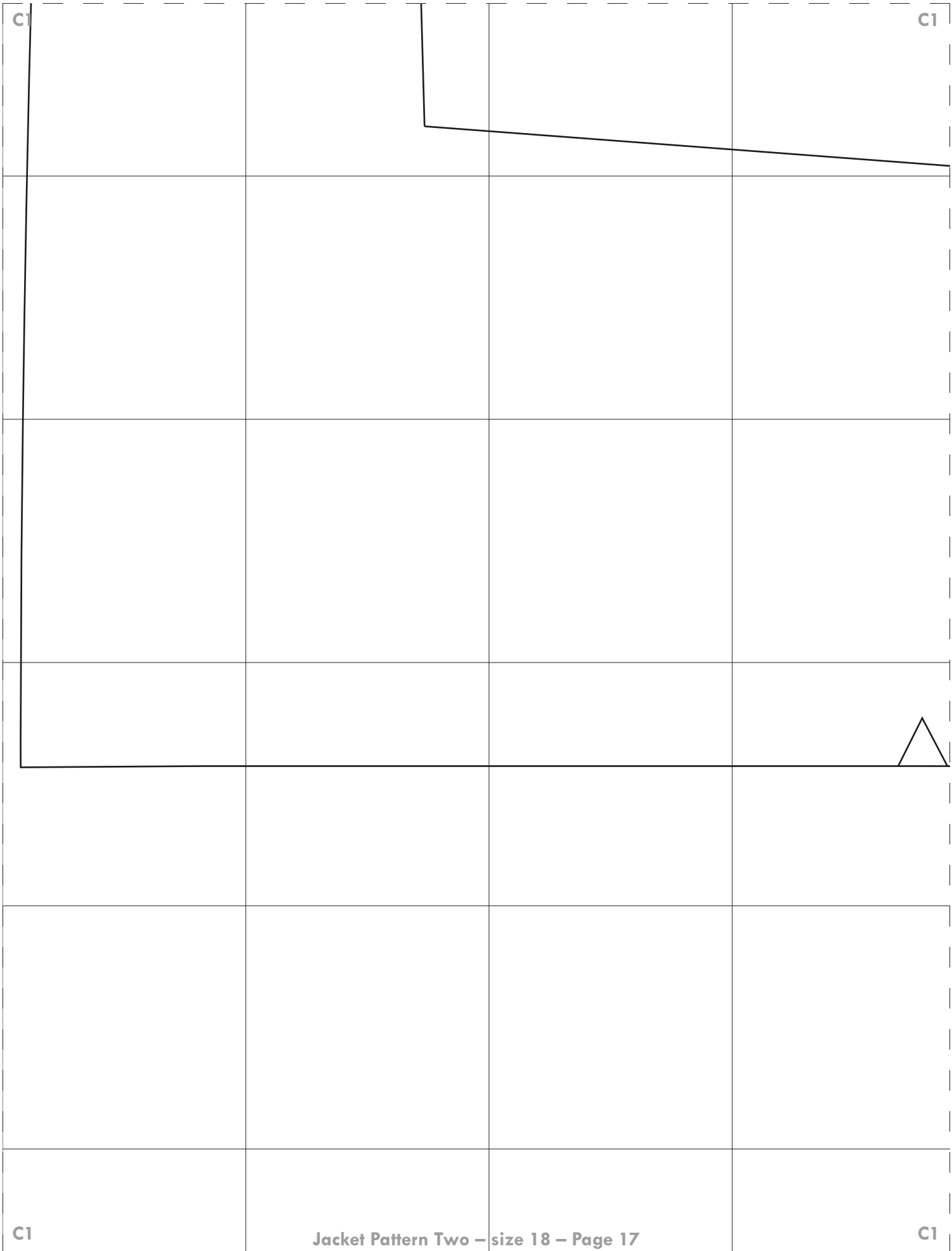

C1

C1

C1

C1

C2

C2

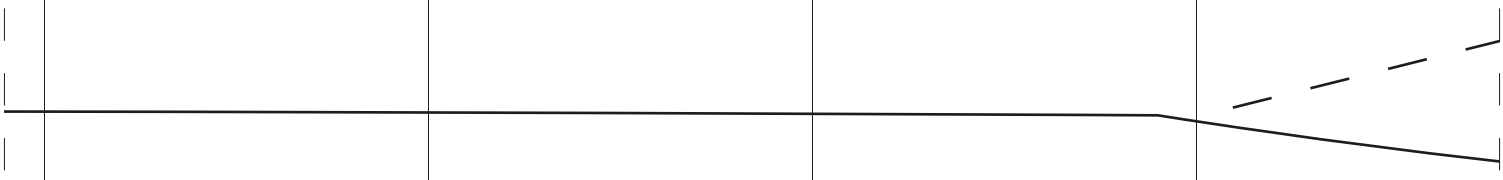
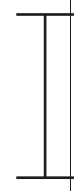
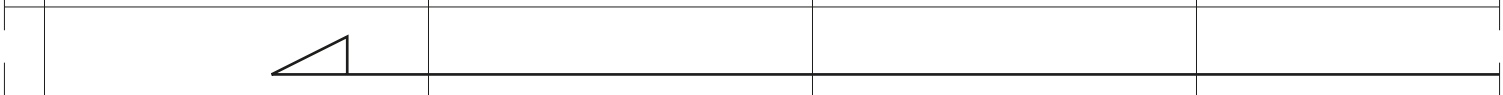

C2

C2

C3

C3

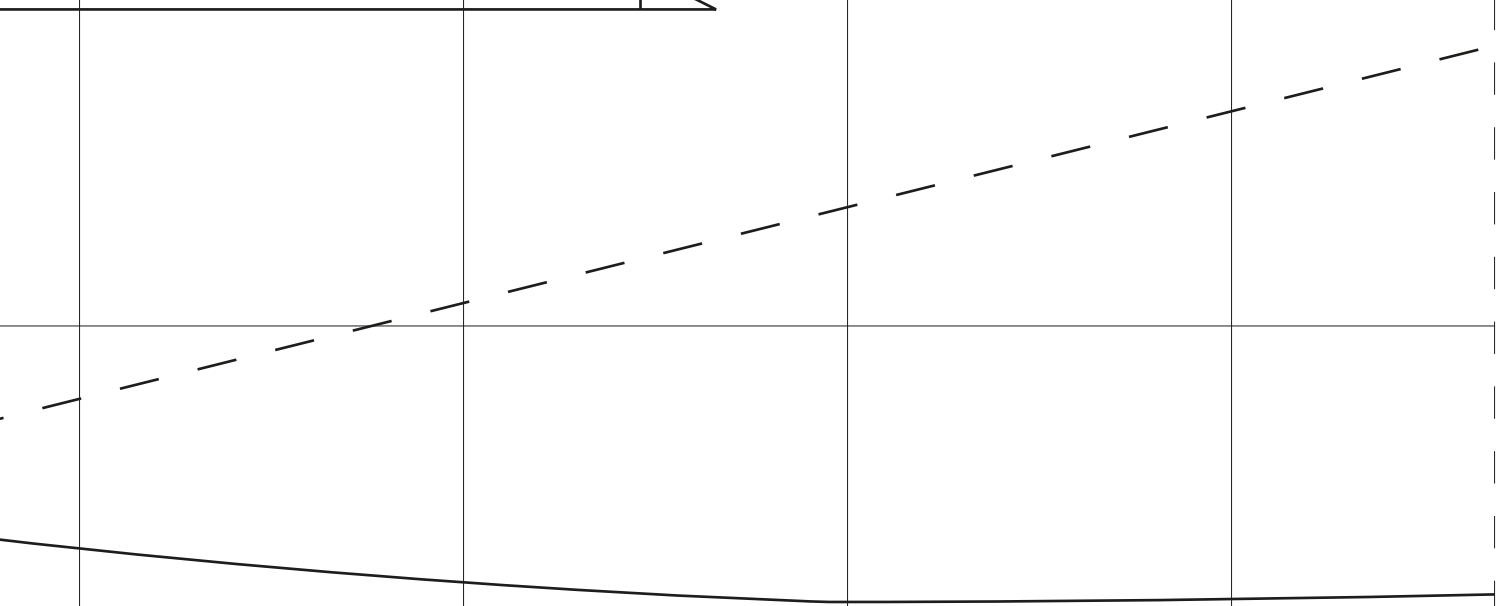

C3

C3

C4

C4

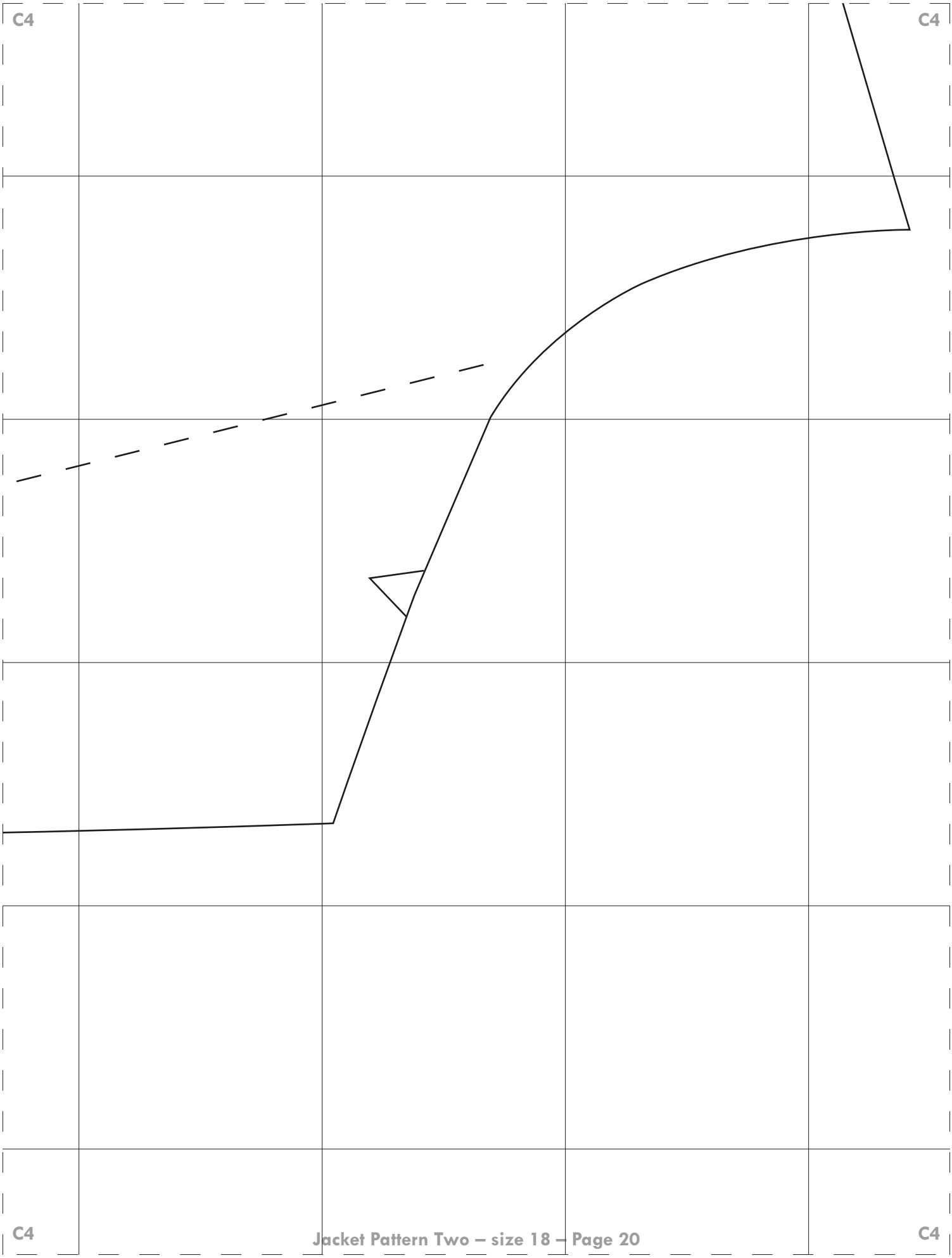

C4

C4

C5

C5

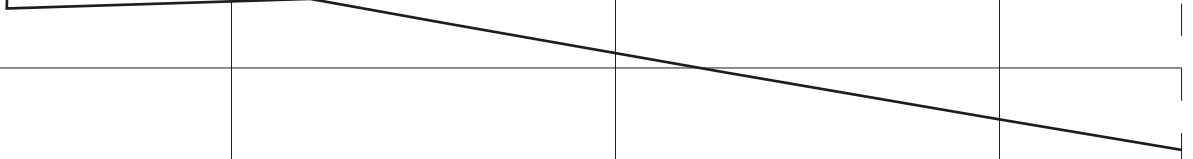

C5

C5

C6

C6

C6

C6

C7

C7

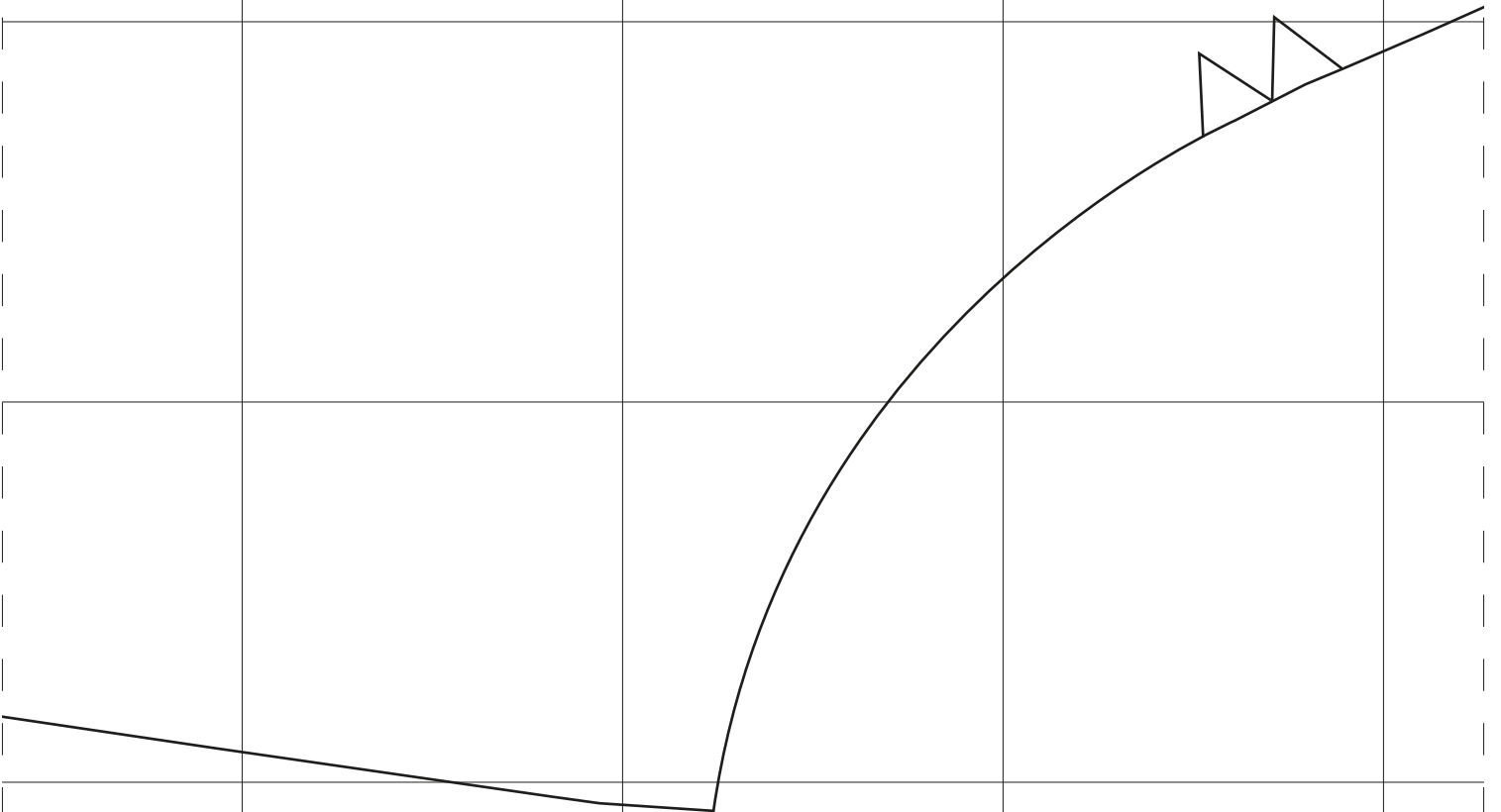

C7

C7

C8

C8

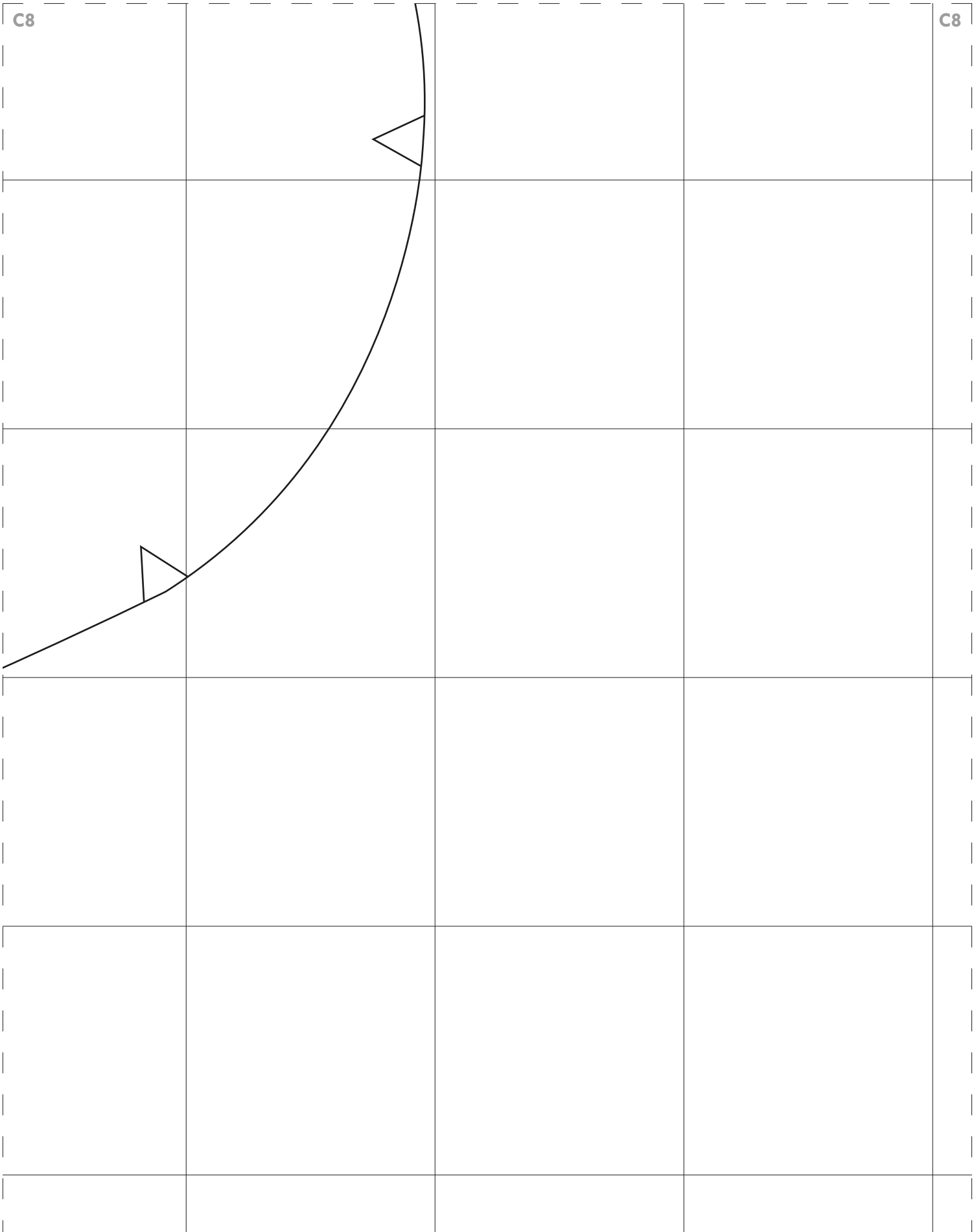

C8

C8



D1

D1

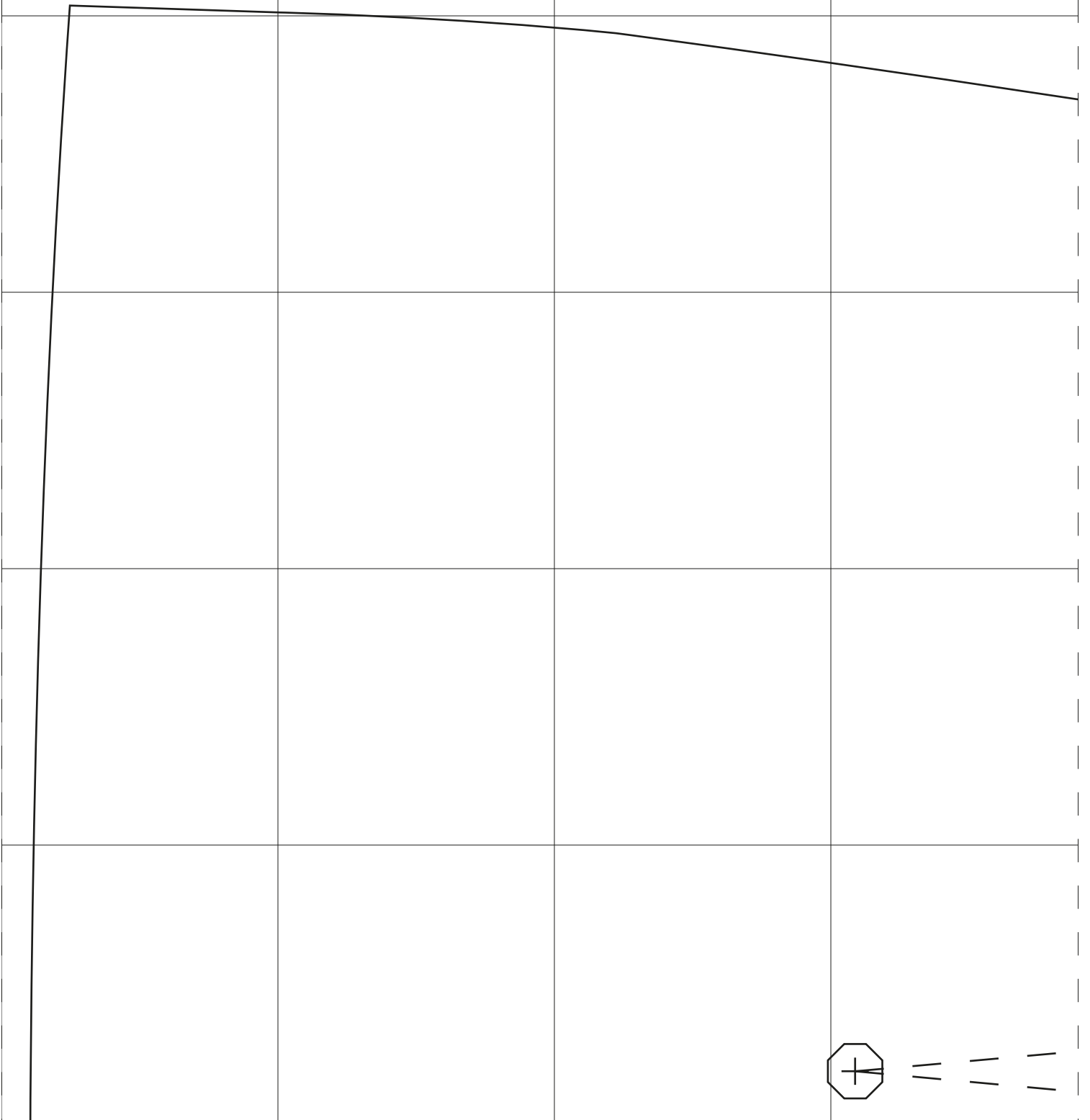

D1

D1

D2

D2

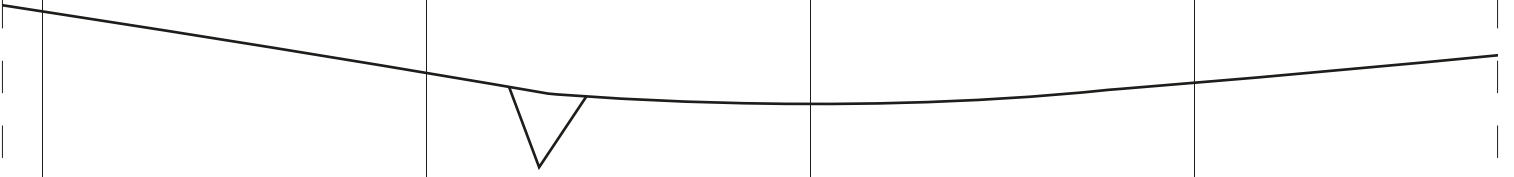

BLAZER BACK  
Cut 2 fabric

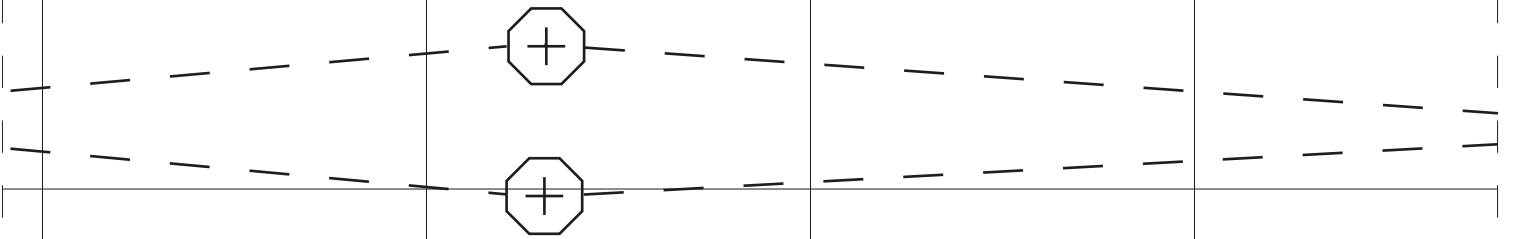

D2

D2

D3

D3

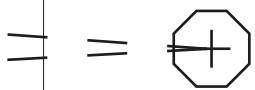
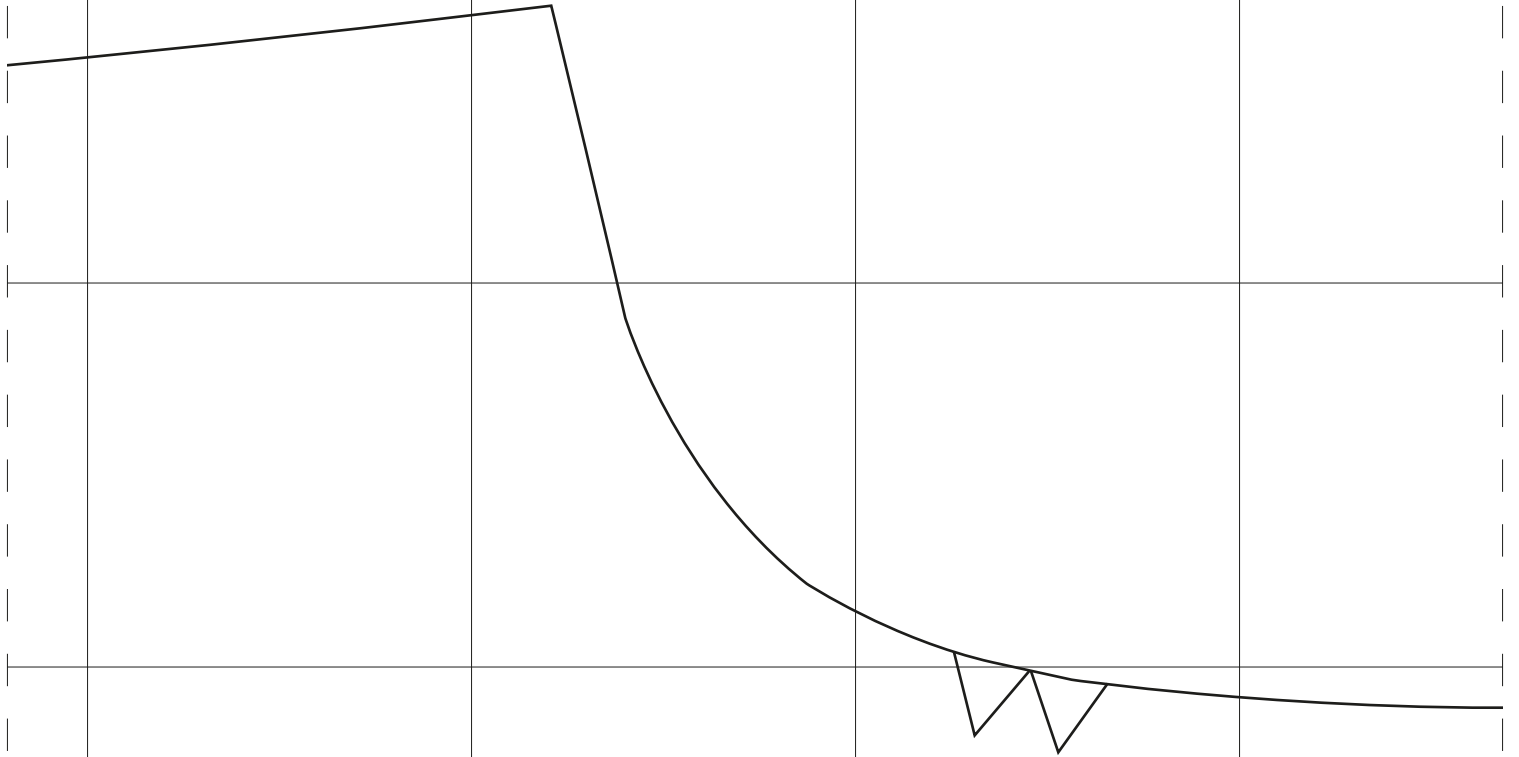

D3

D3

D4

D4

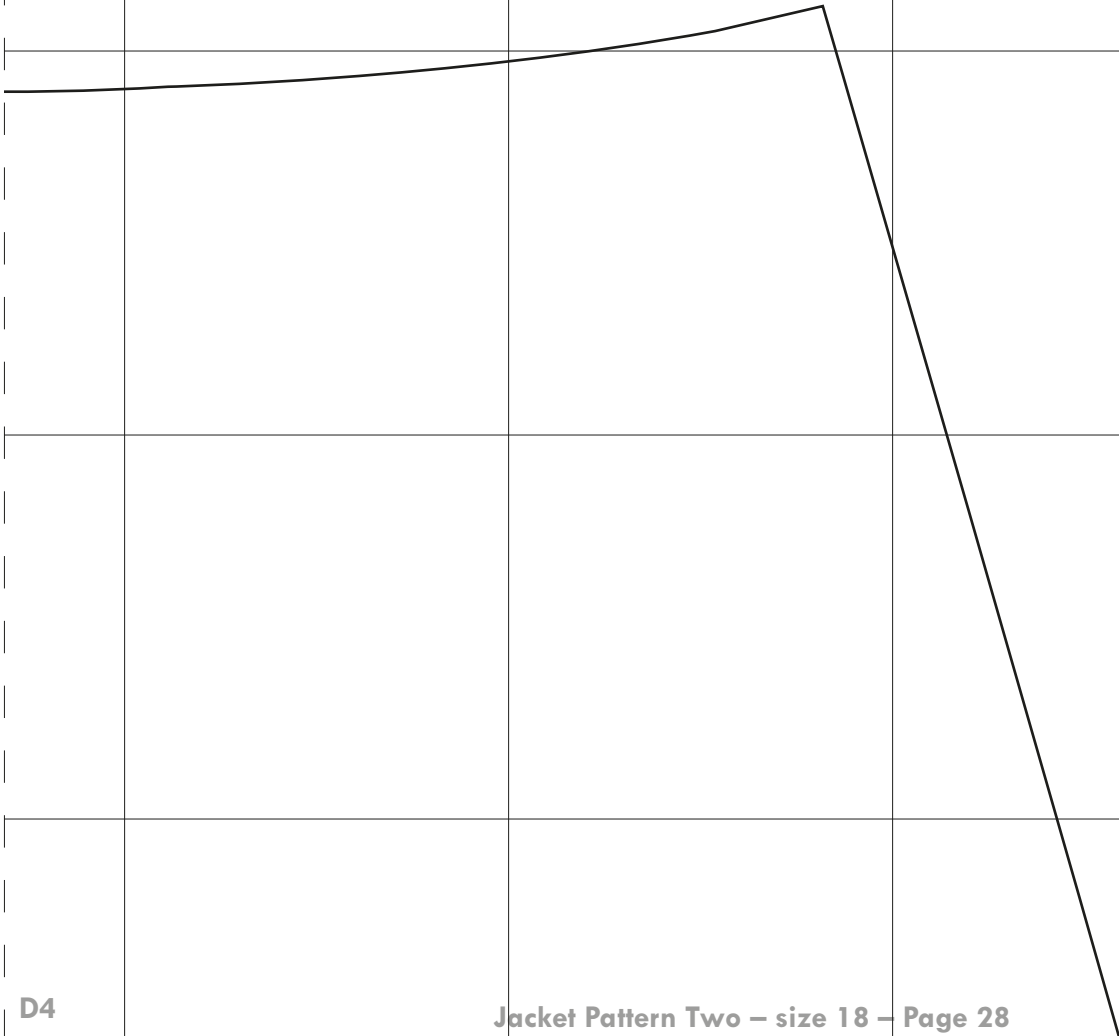

D4

D4

**BACK NECK FACING**

Cut 1 on fold of fabric  
Cut 1 on fold of interfacing

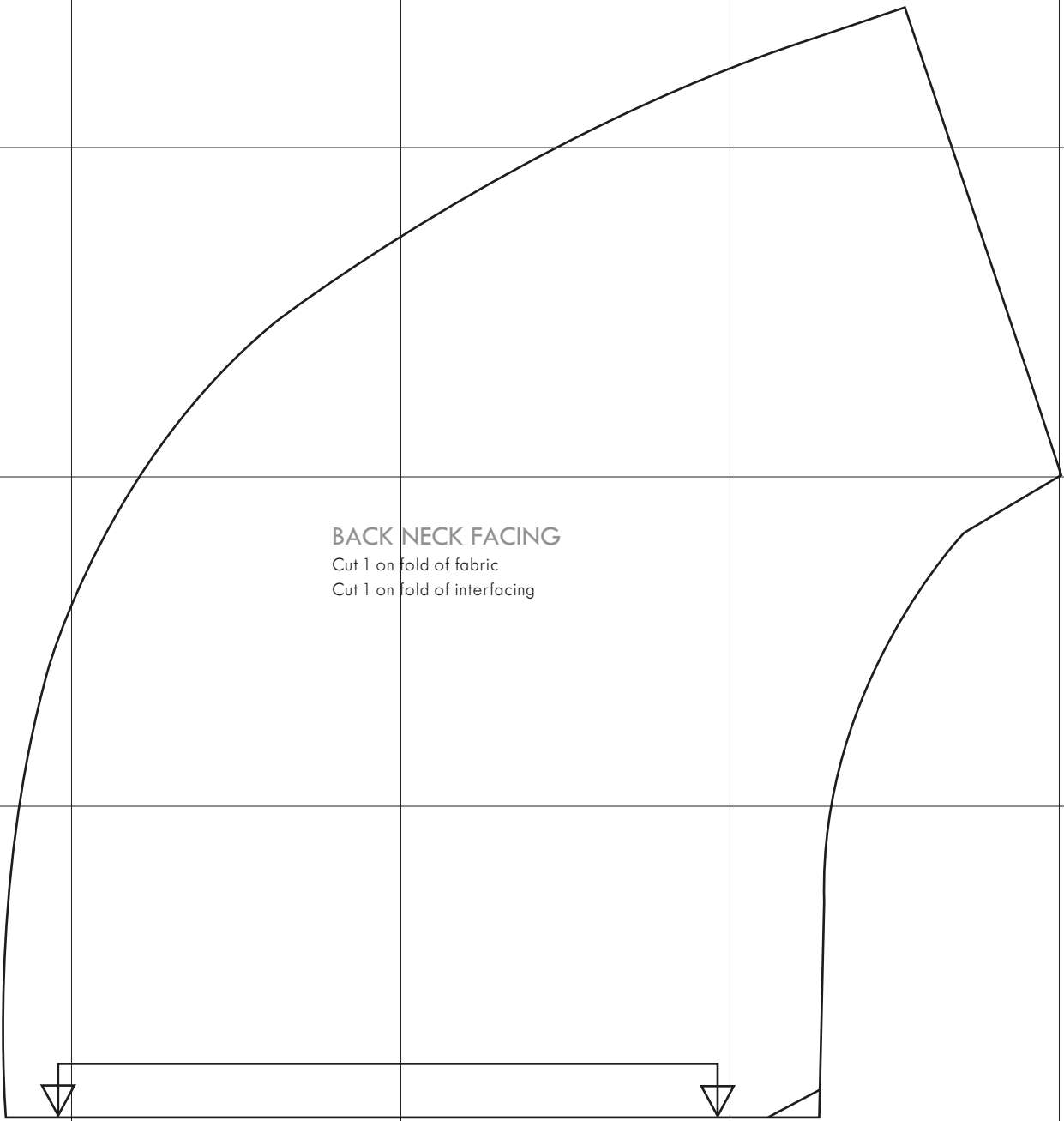

E1

E1

E1

E1



E3

E3

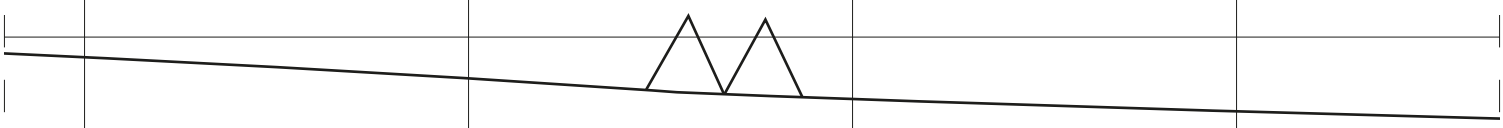

E3

E3



E4

E4

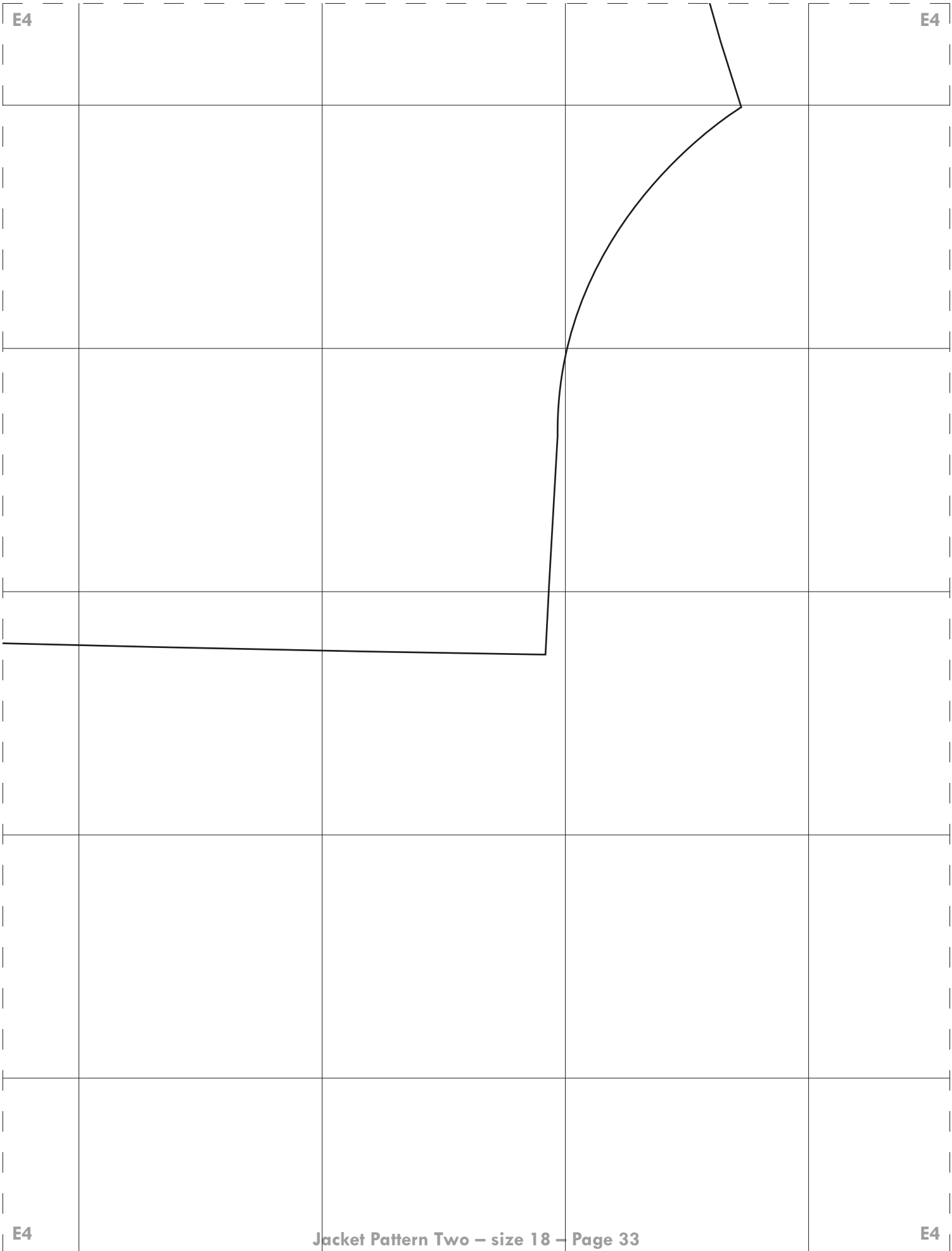

E4

E4

E5

E5

COLLAR TOP  
Cut 1 on fold of fabric



E5

E5

