



CB







WAISTBAND
Cut 1



CF



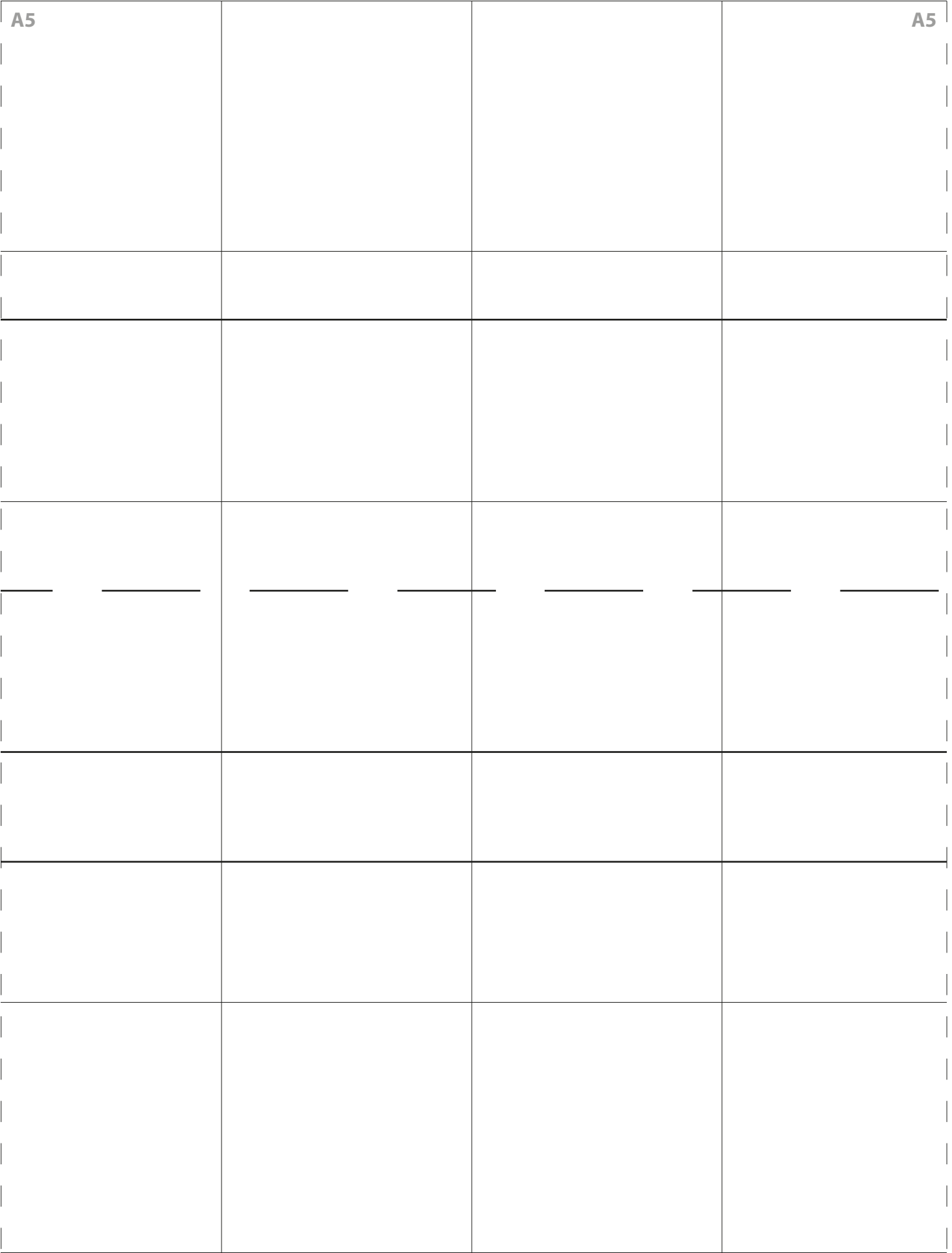

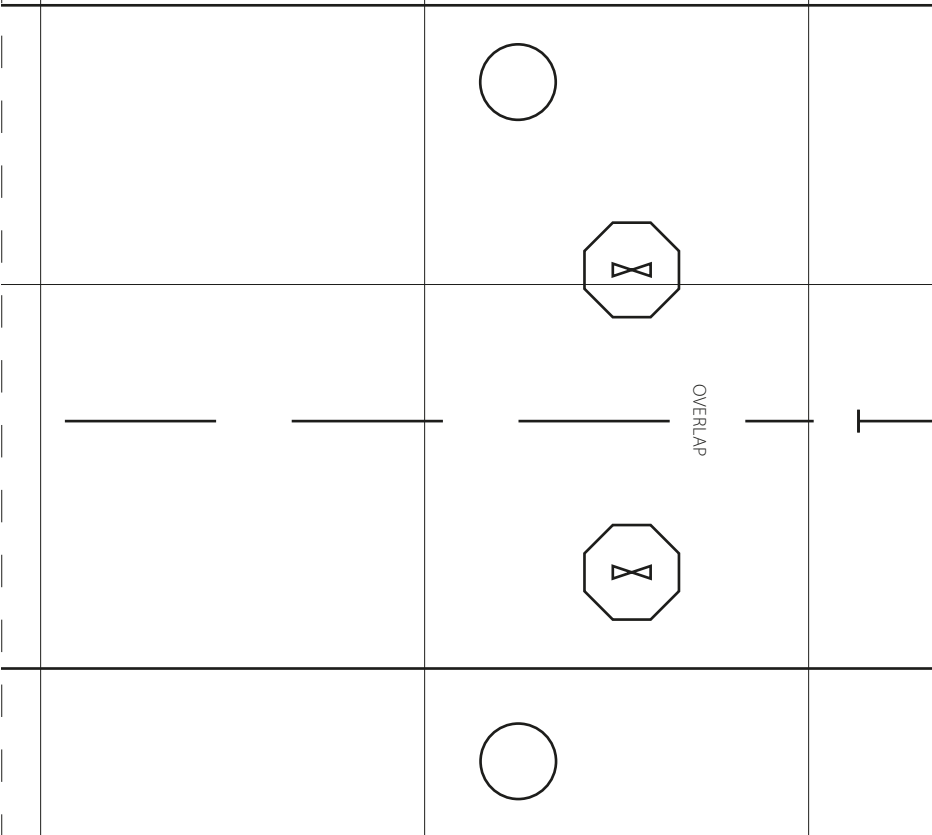

B1

B1

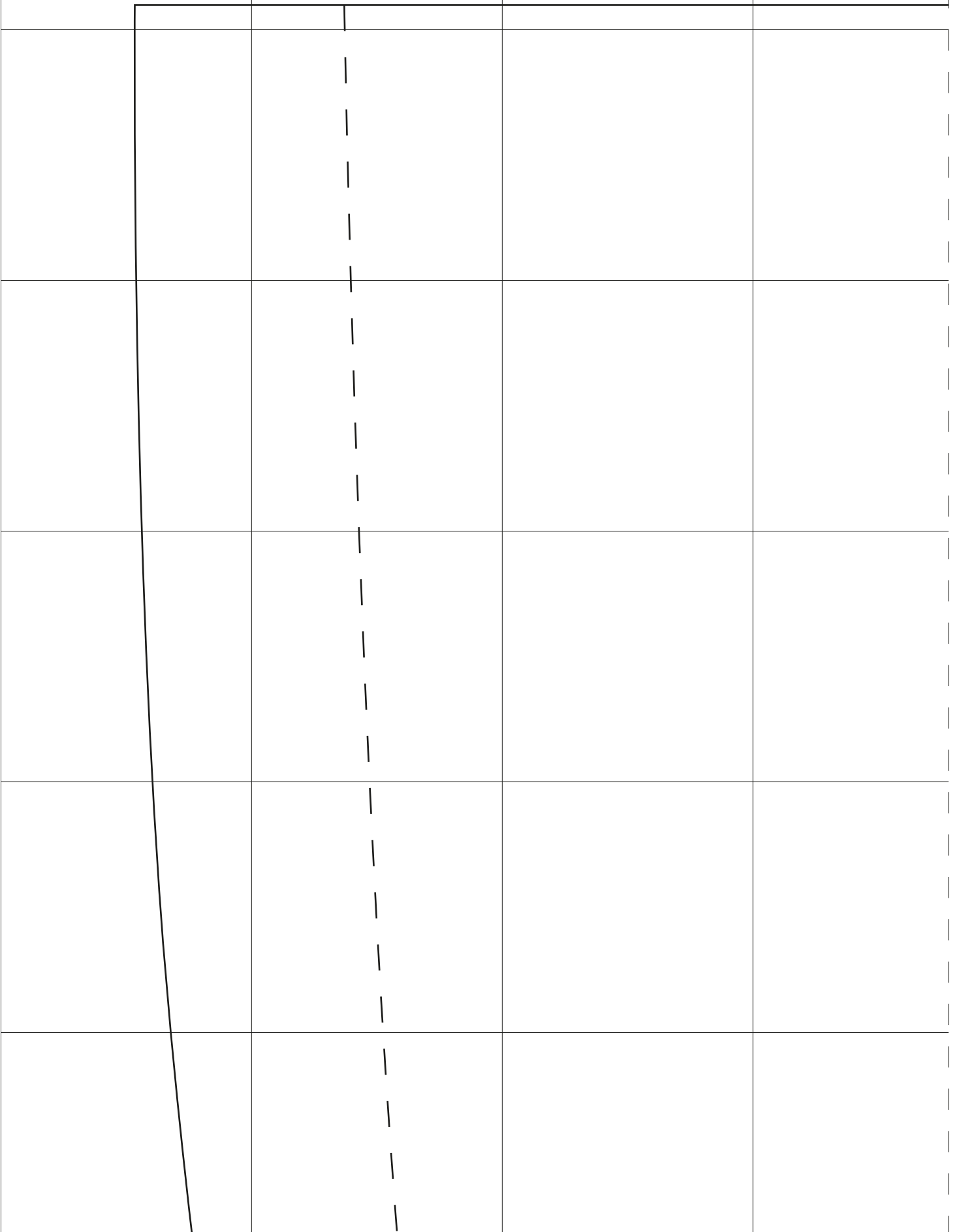

B1

B1

FOLD

SKIRT BACK
Cut 1 on folded fabric

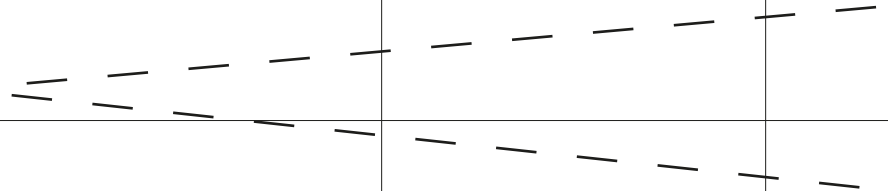

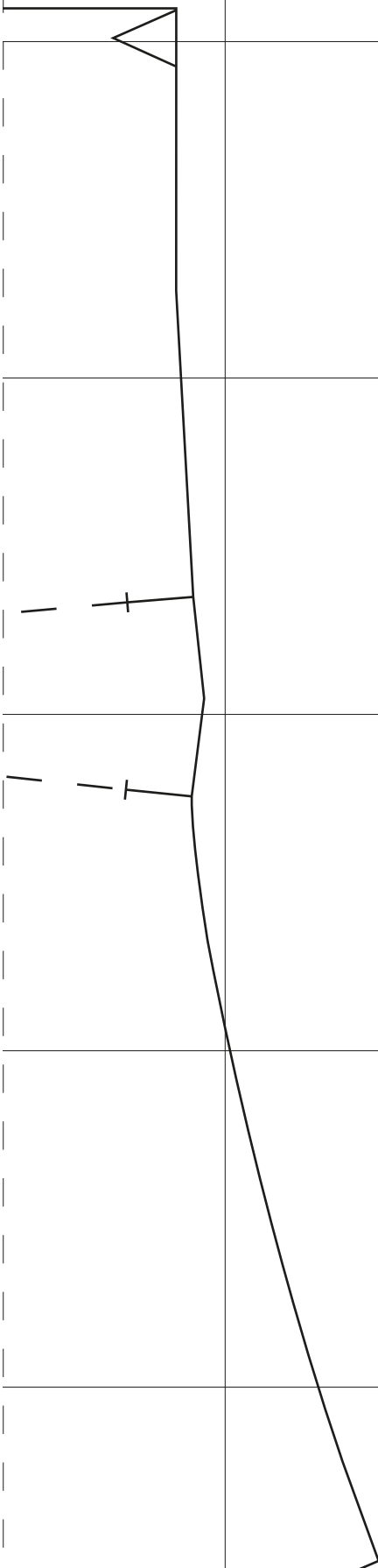

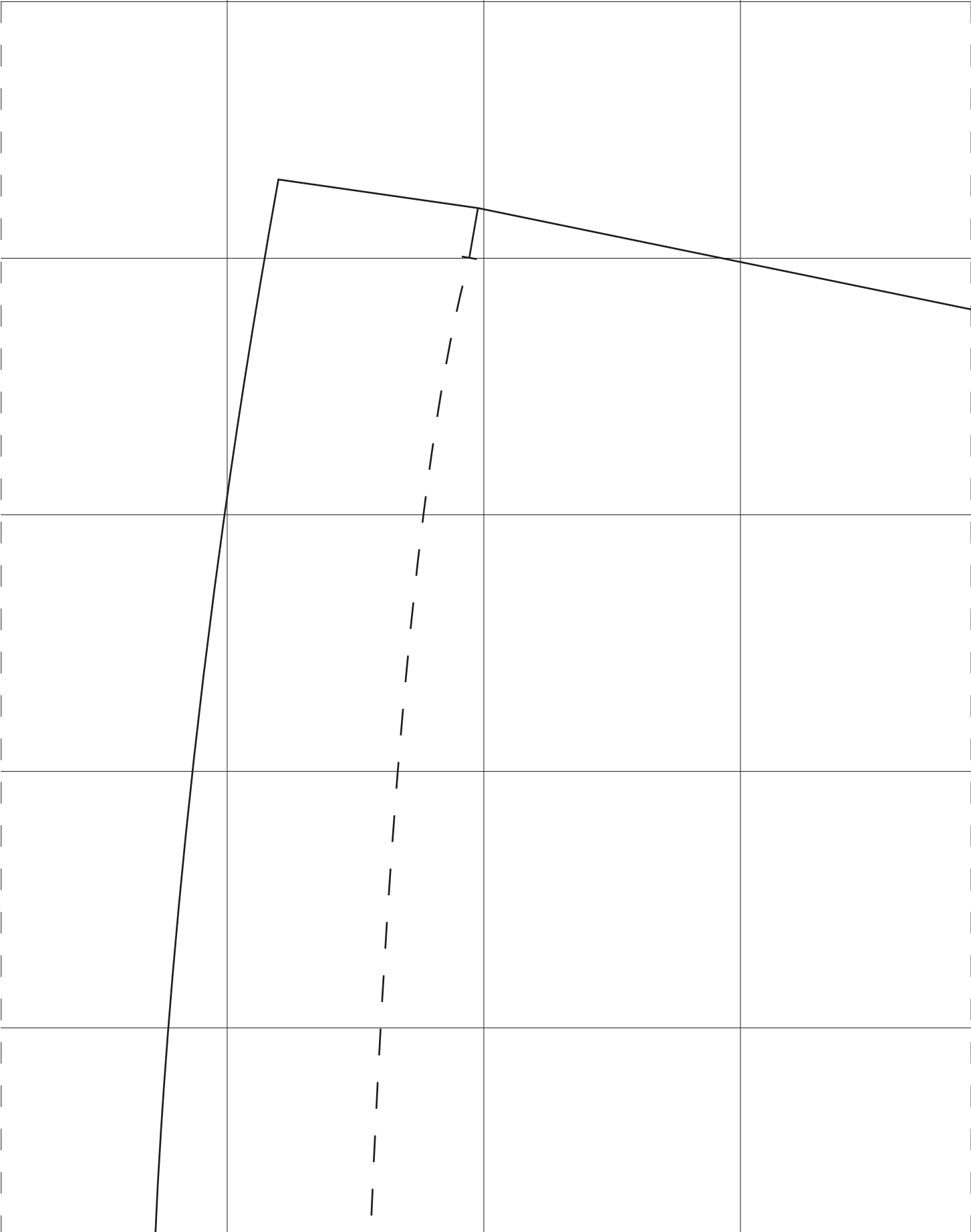

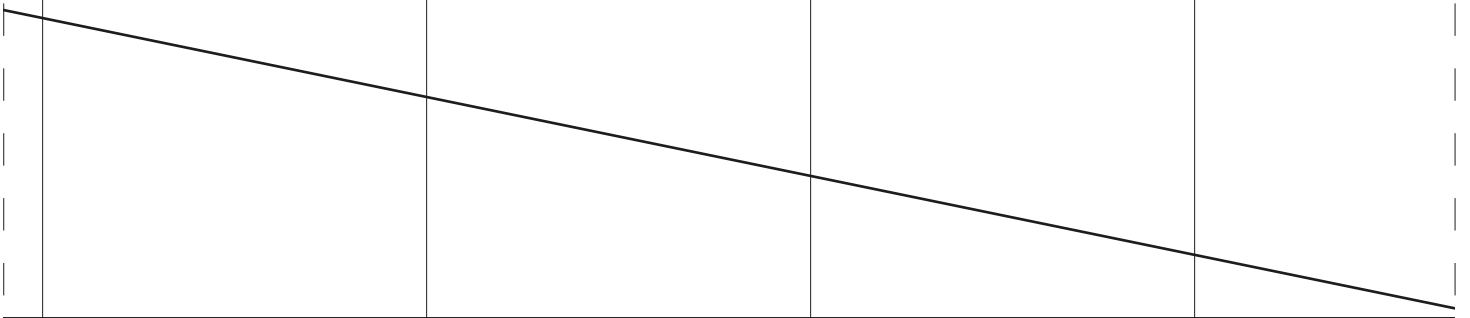

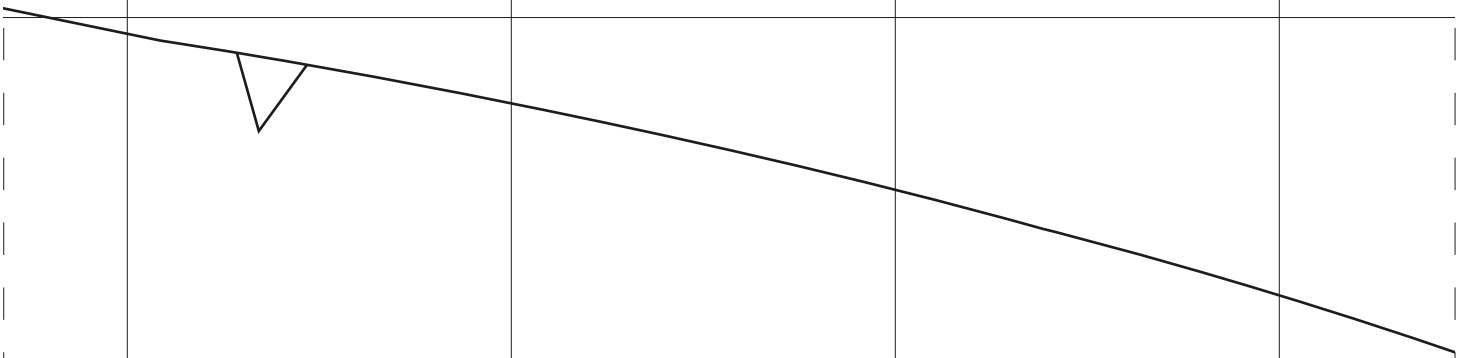

B8

B8

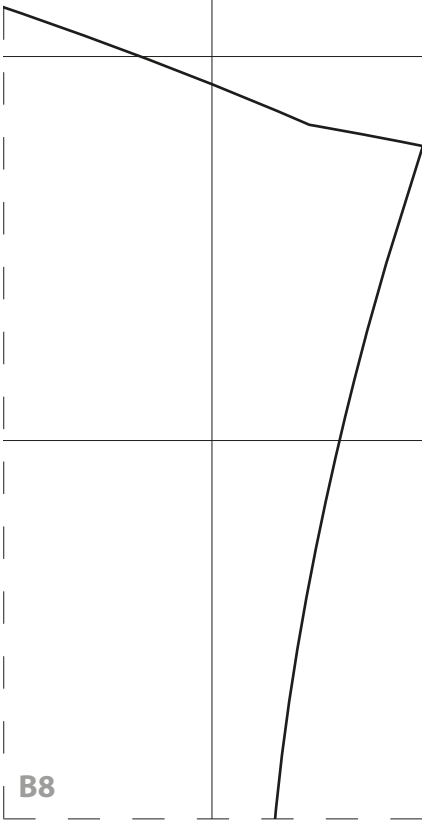

B8

B8

C1

C1

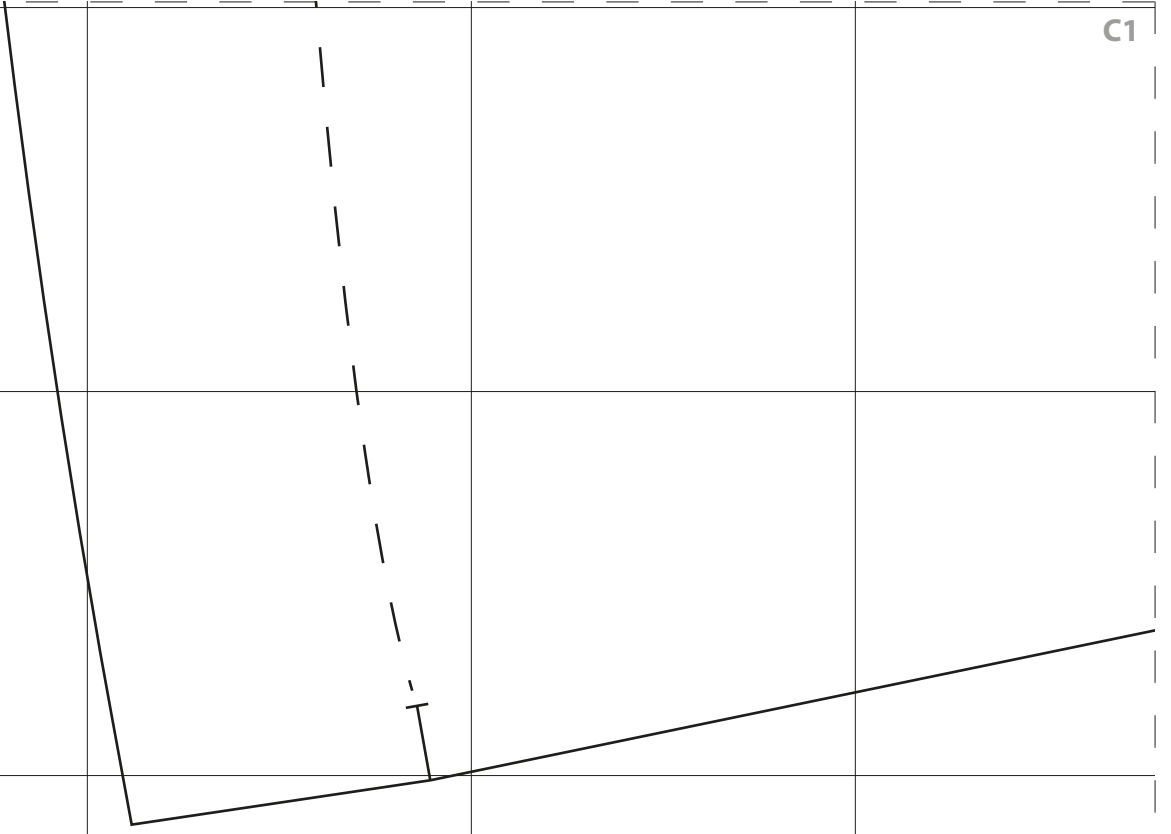

C1

C1

C2

C2

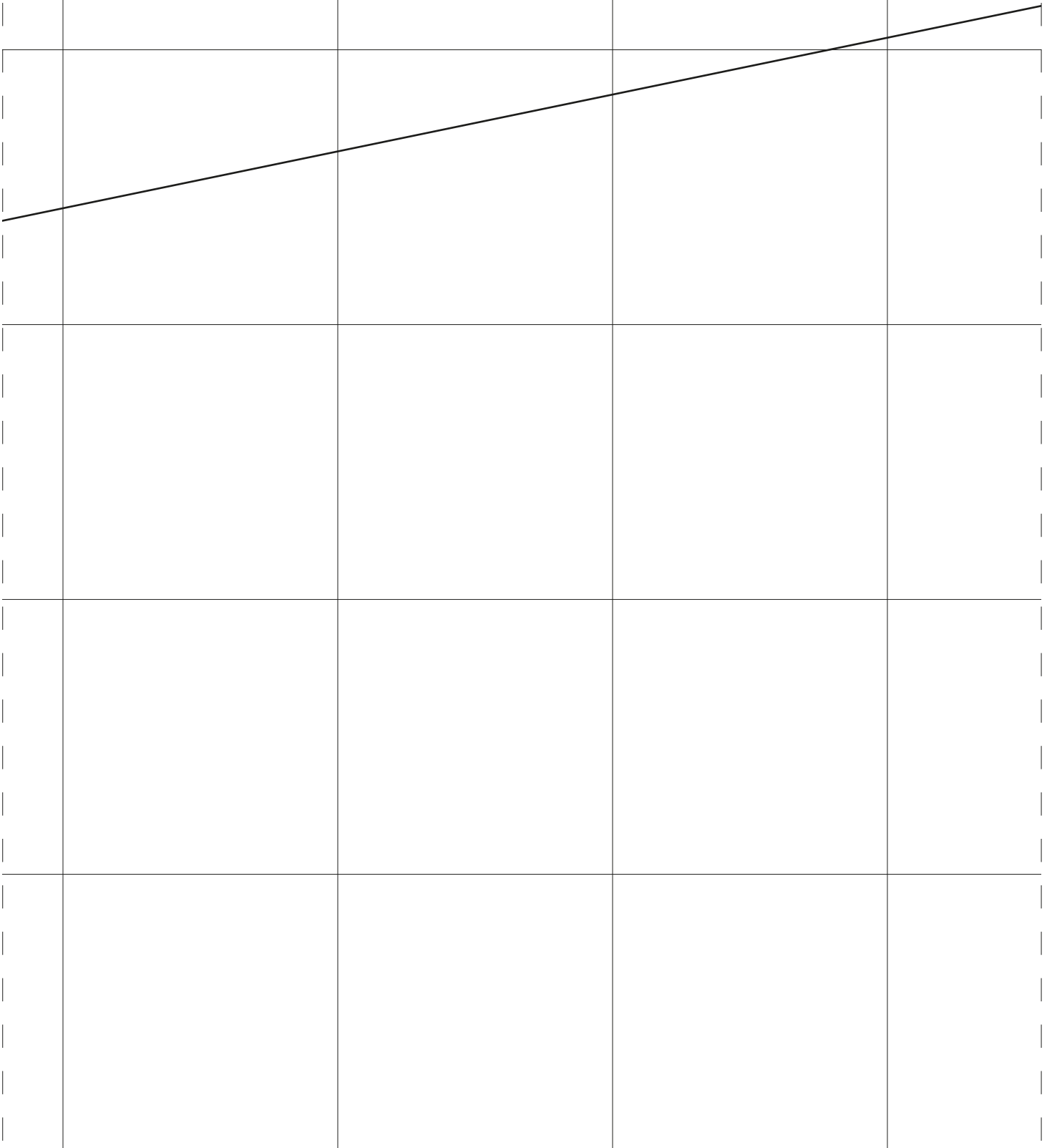

C2

C2

C3

C3

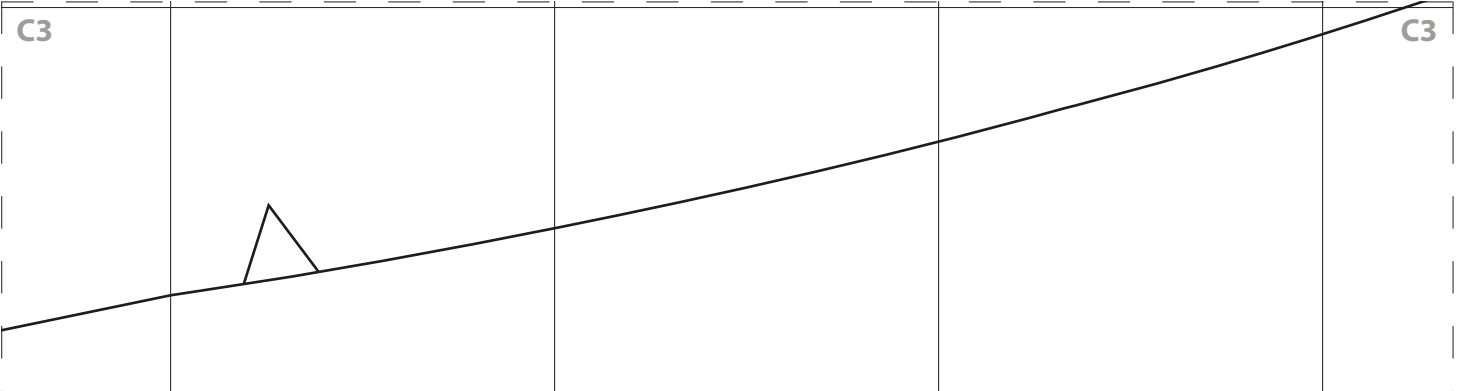

C3

C3

C4

C4

C4

C4

C5

C5

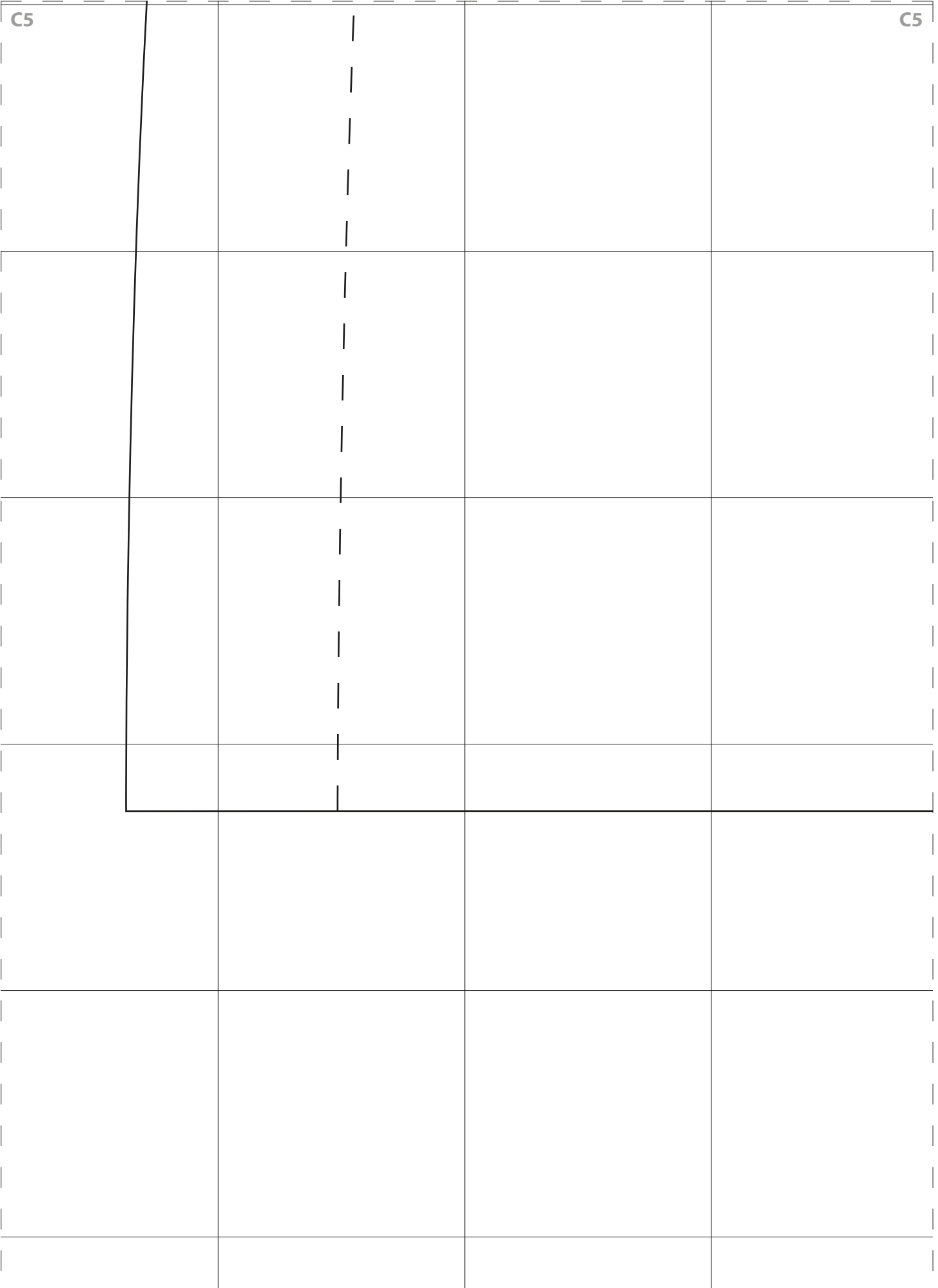

C5

C5

C6

C6

SKIRT FRONT
Cut 1 on folded fabric



C6

C6

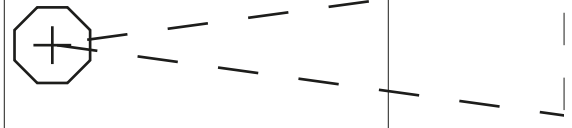

C8

C8

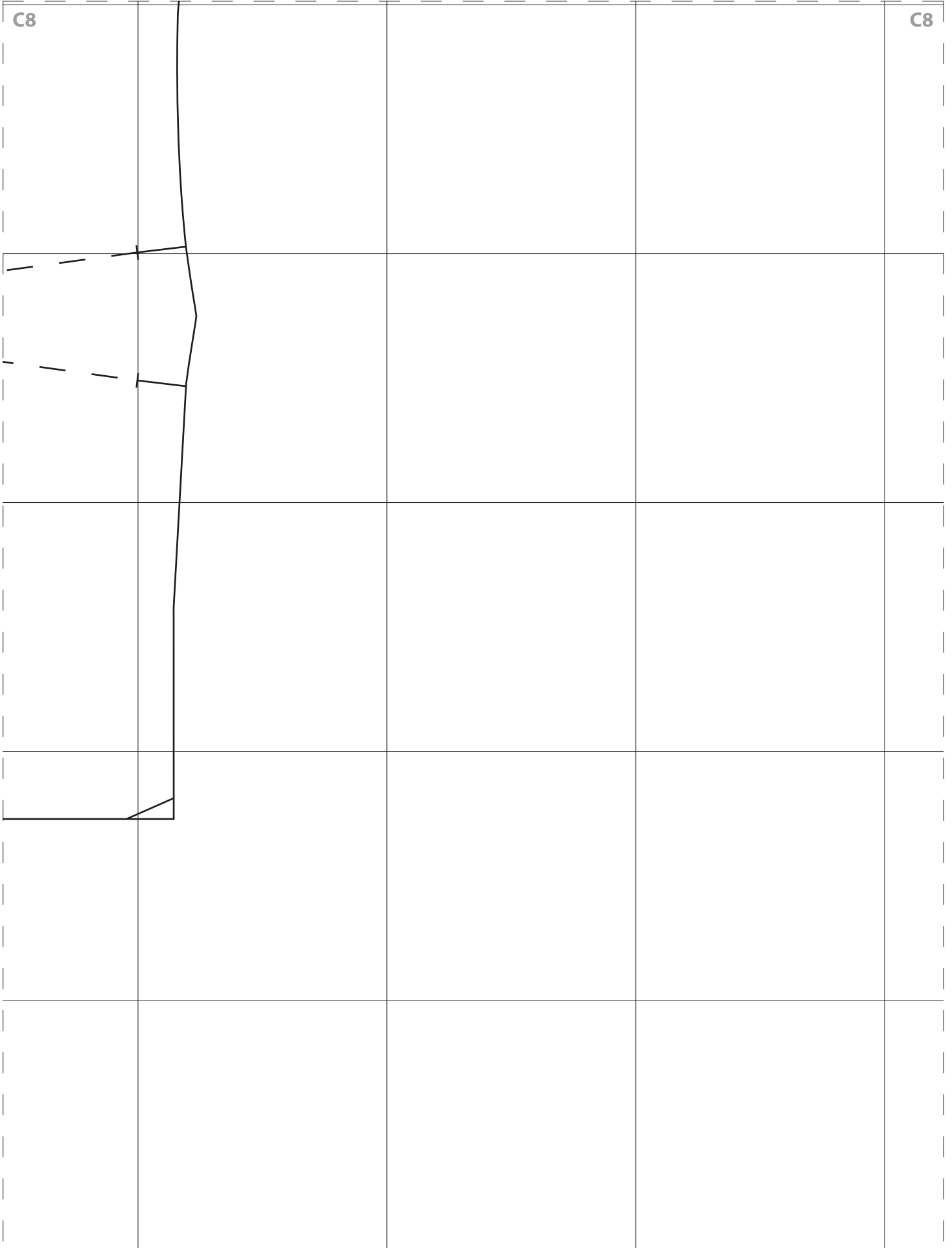

C8

C8