

A1

A1

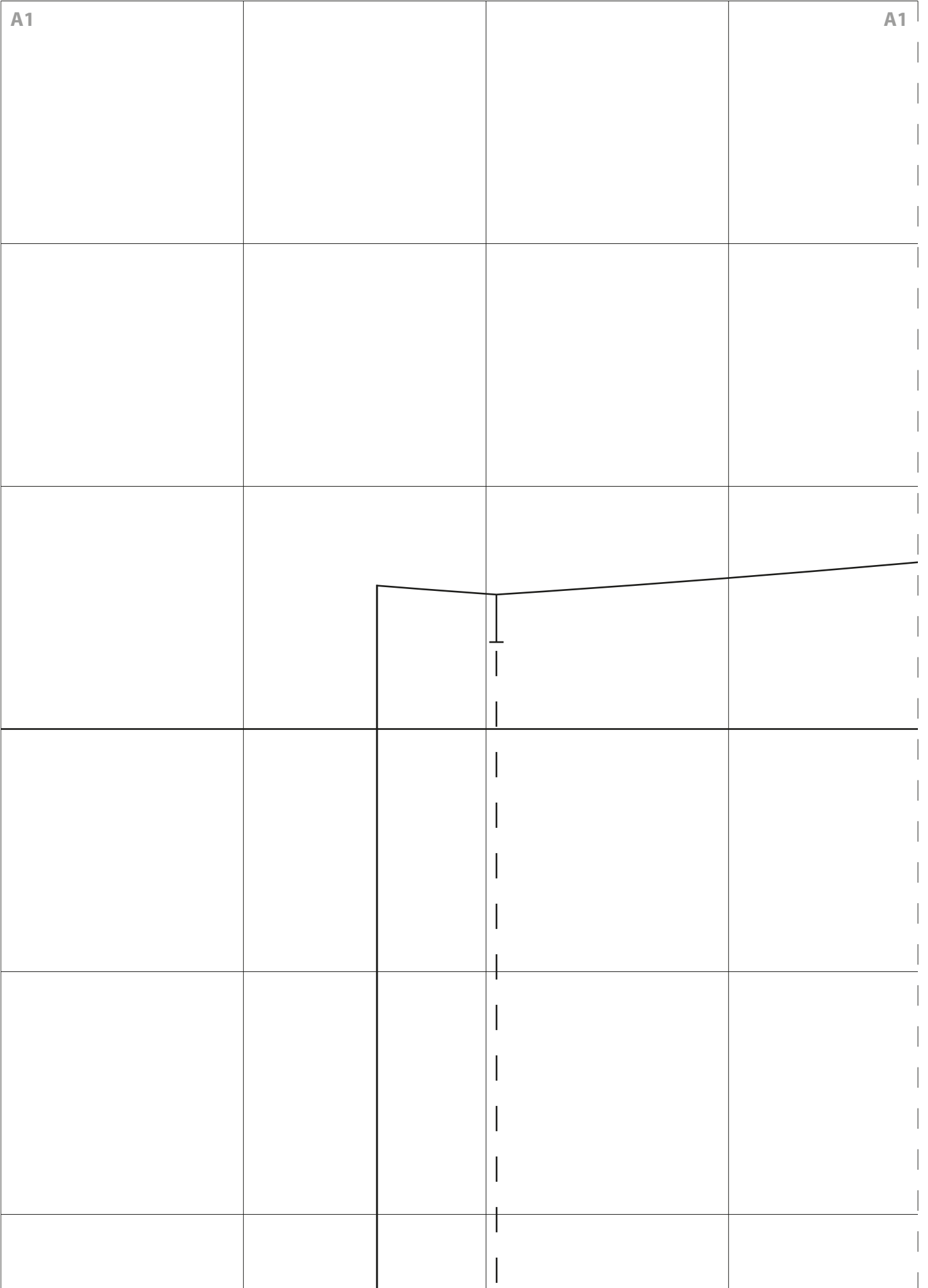

A1

A1

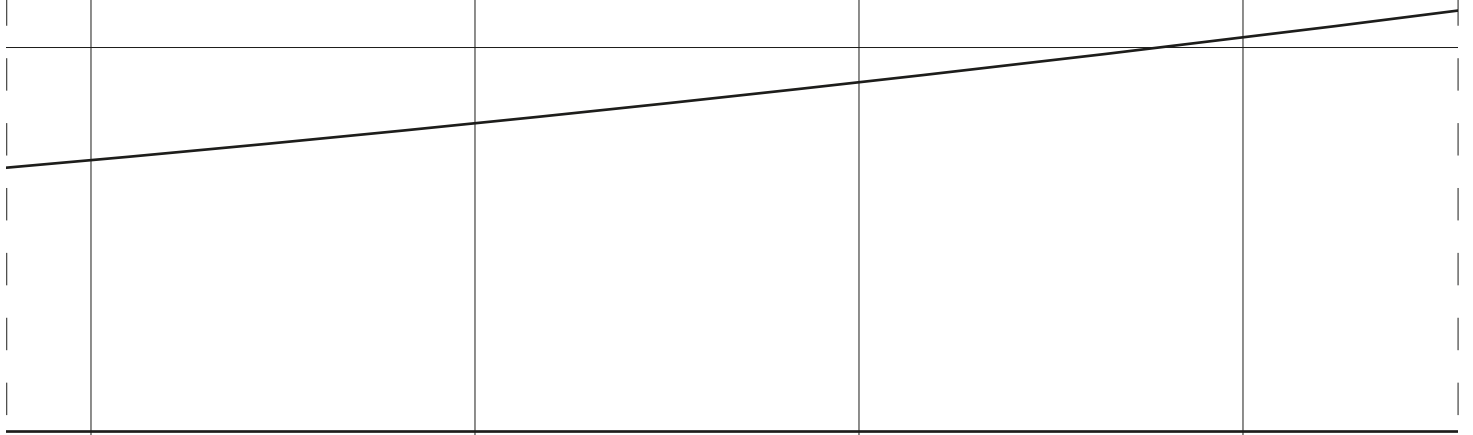

SLEEVE  
Cut 2 fabric



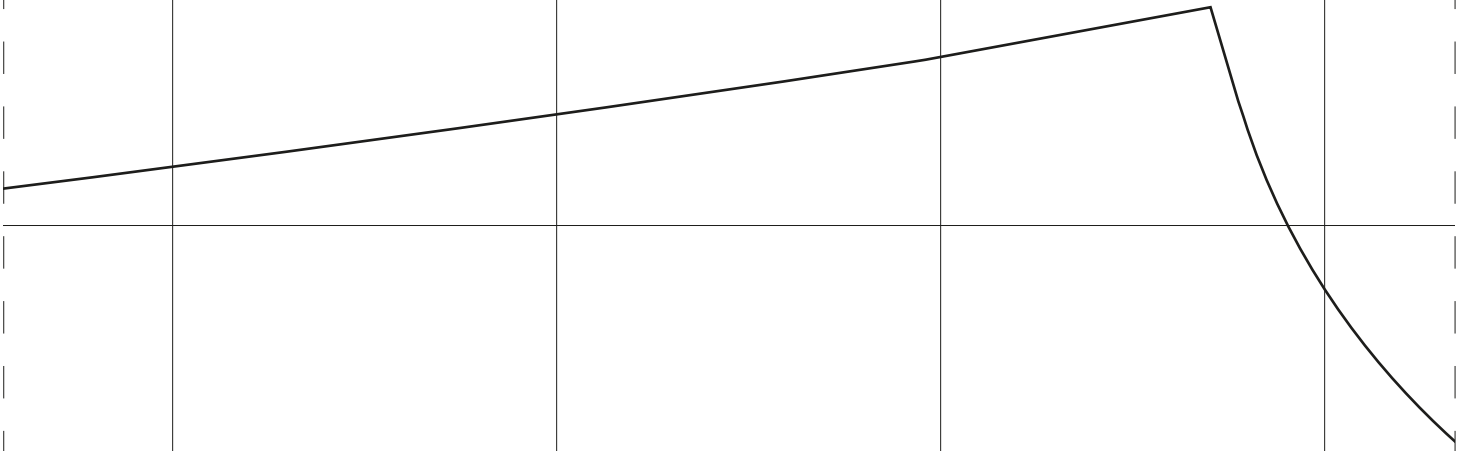

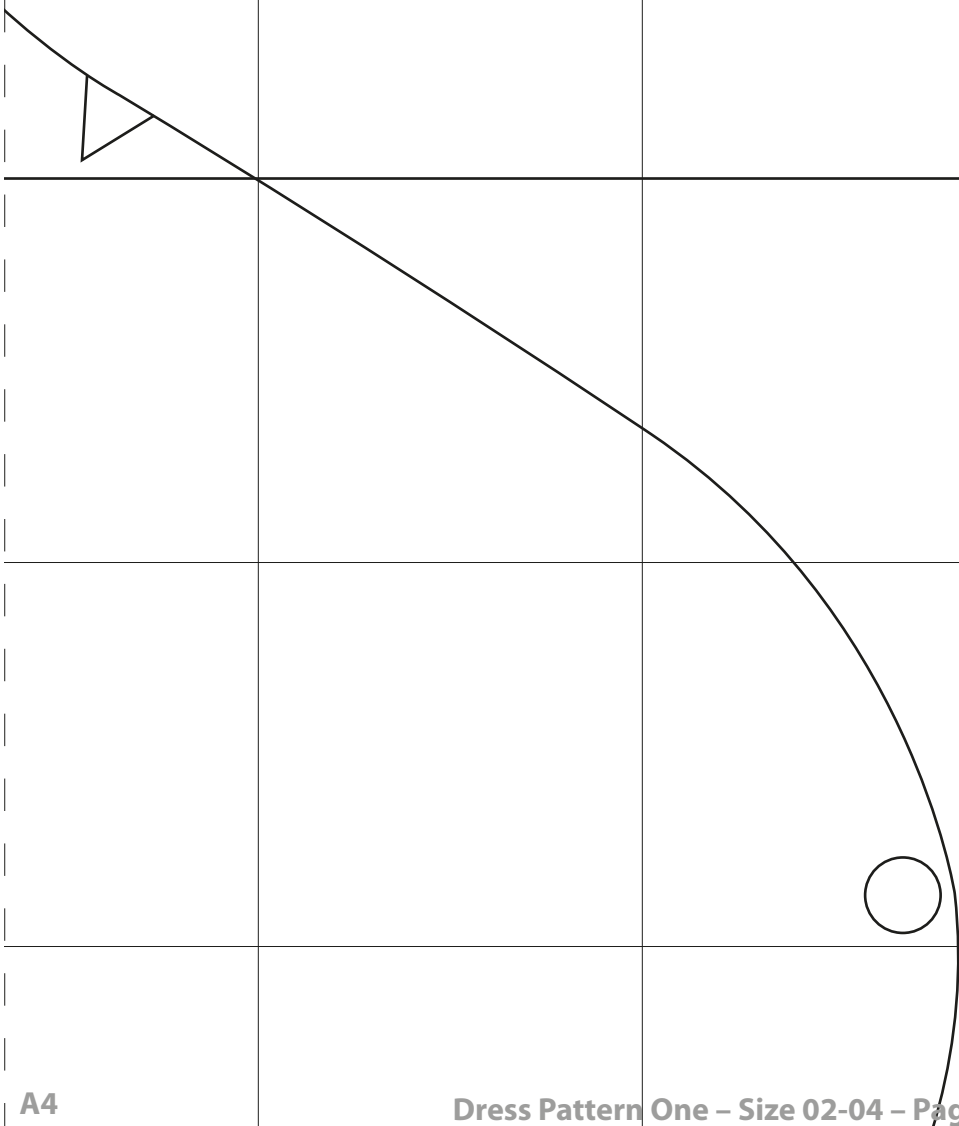

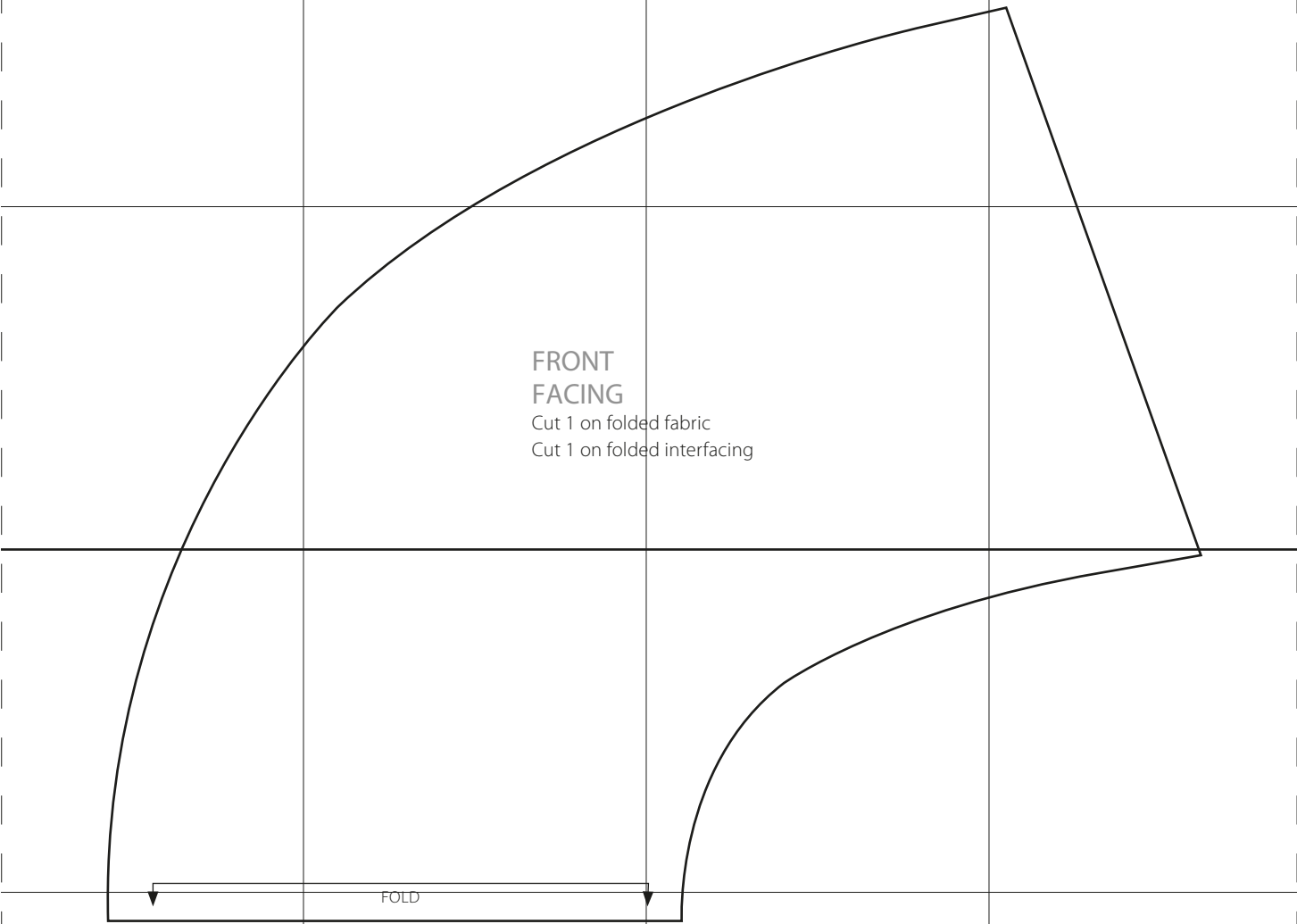

FRONT  
FACING  
Cut 1 on folded fabric  
Cut 1 on folded interfacing

FOLD

B1

B1

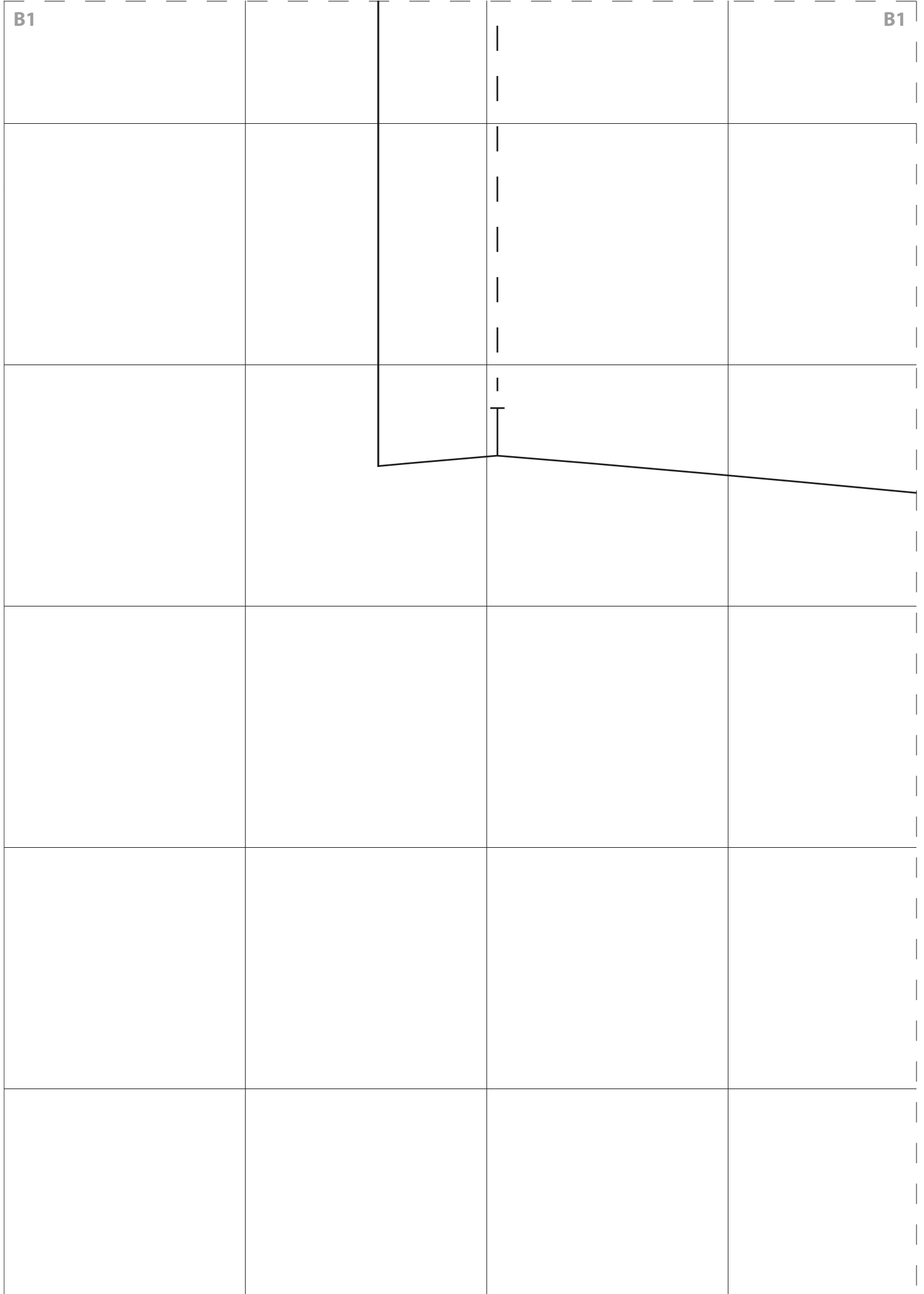

B1

B1

B2

B2

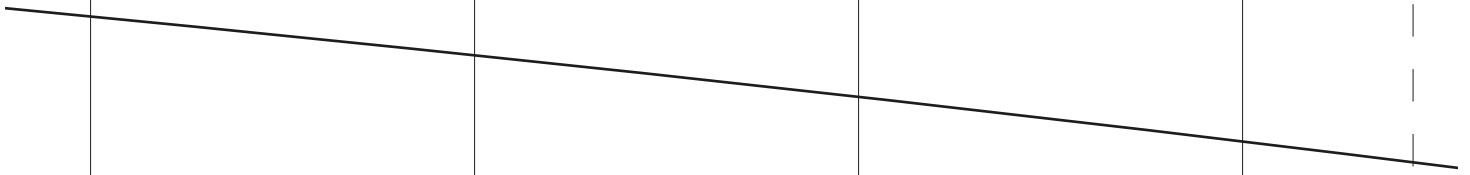

B2

B2

B3

B3

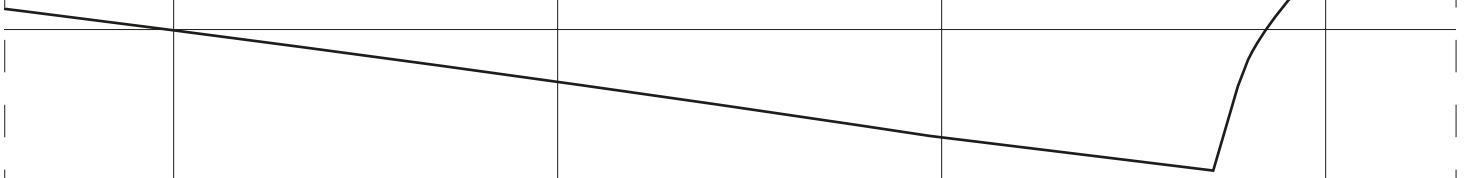

B3

B3



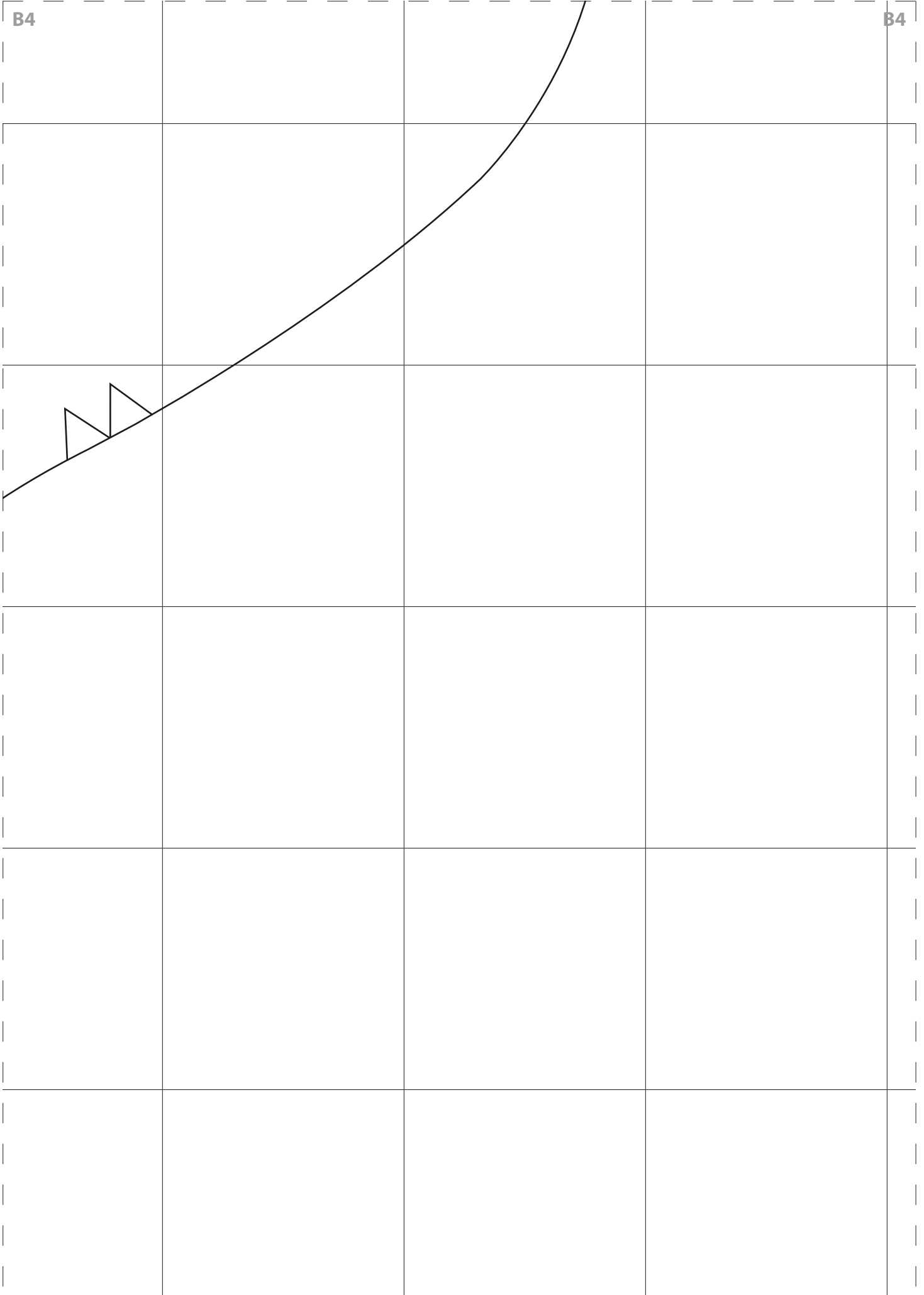

CB

BACK  
FACING  
Cut 2 fabric  
Cut 2 interfacing



C1

C1

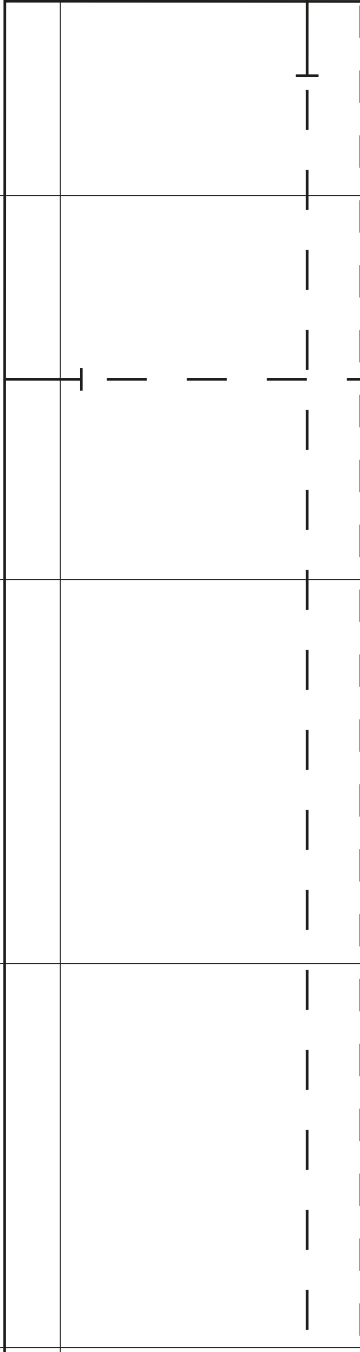

C1

C1

C2

C2

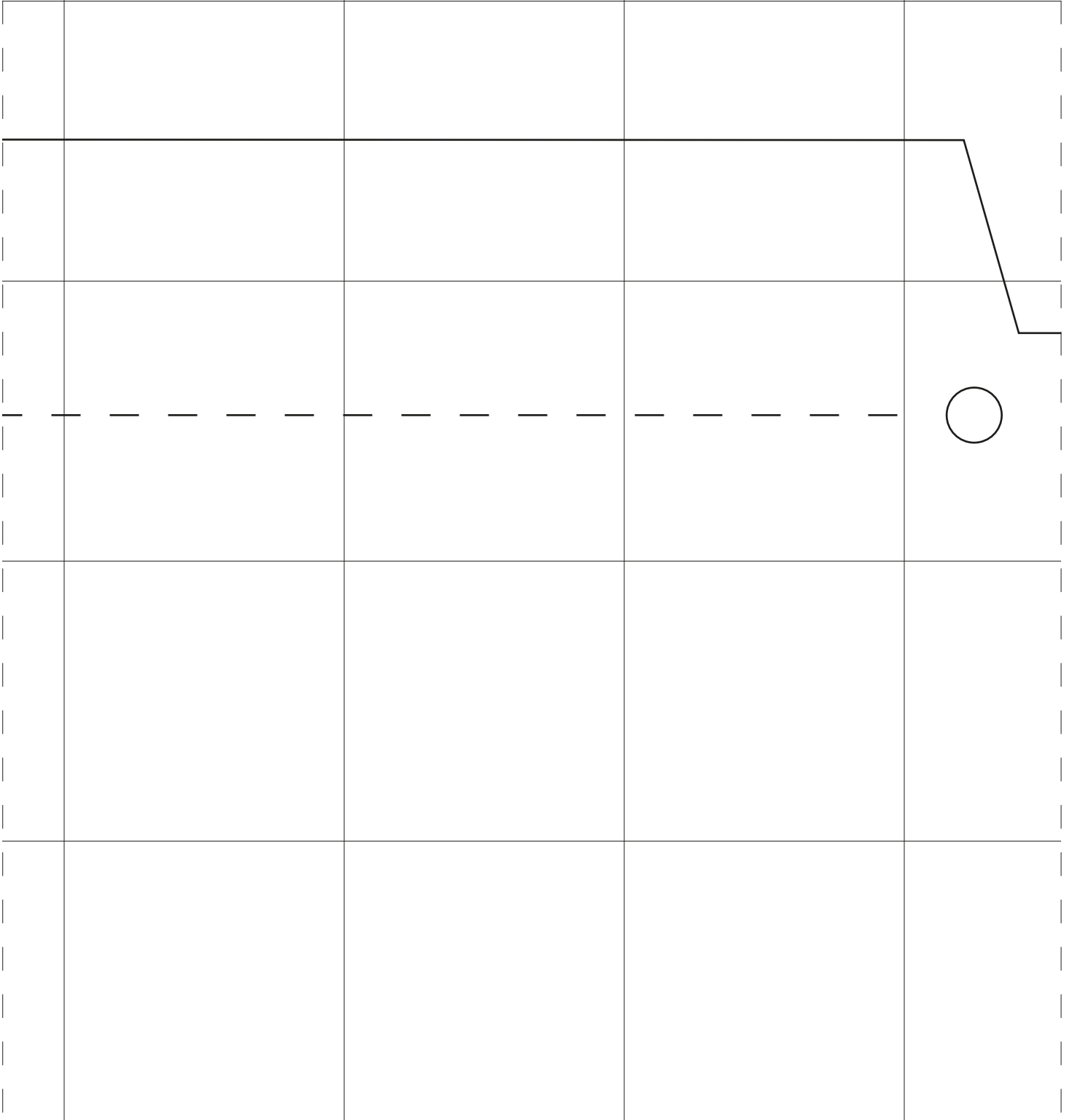

C2

C2

C3

C3

DRESS BACK  
Cut 2 fabric



C3

C3

C4

C4

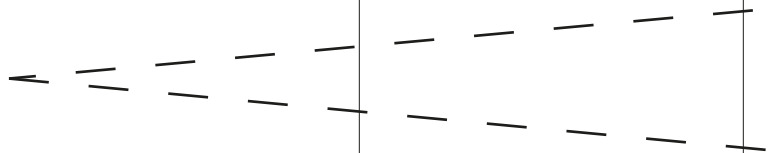

C4

C4

C5

C5

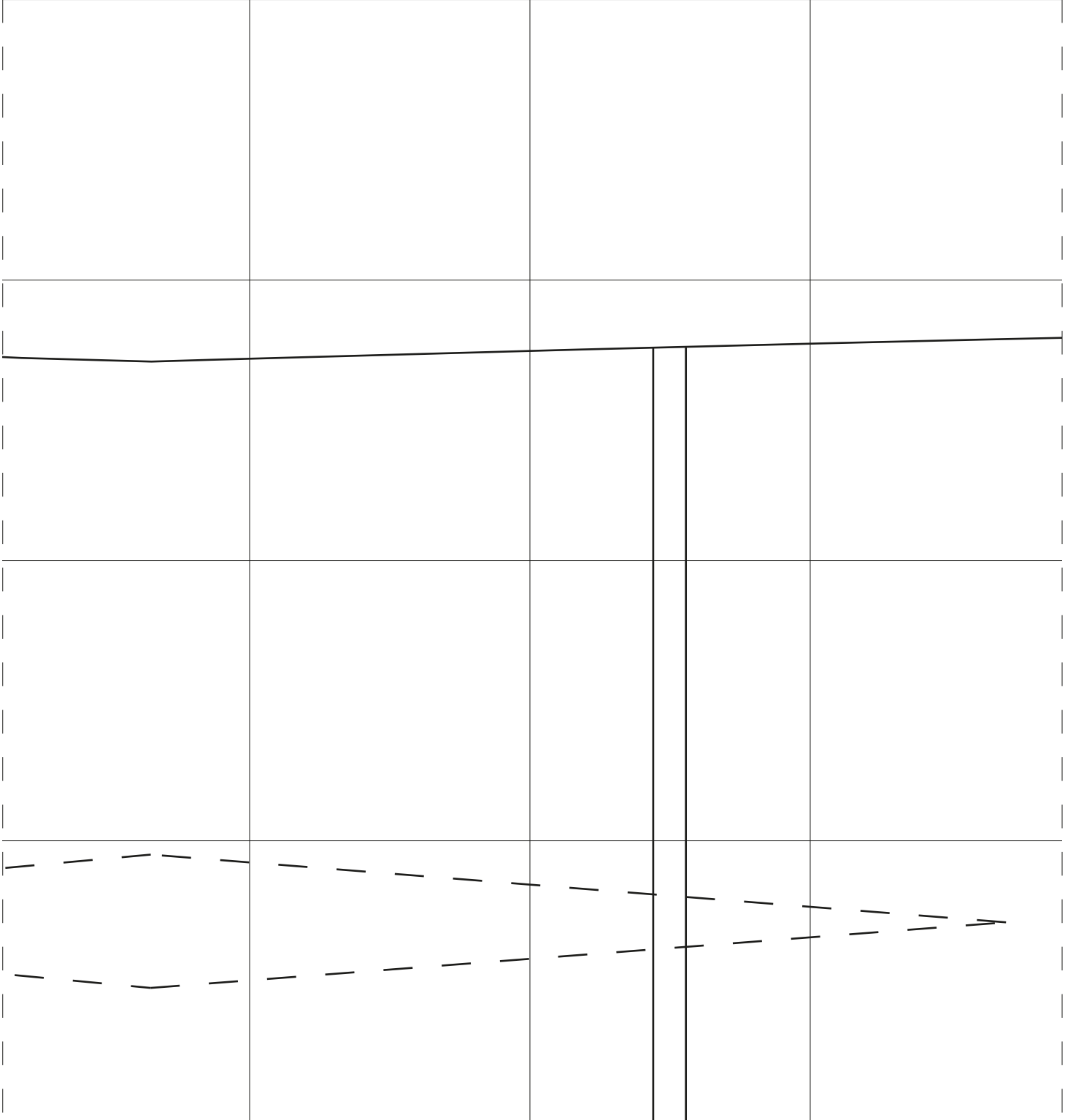

C5

C5

C6

C6

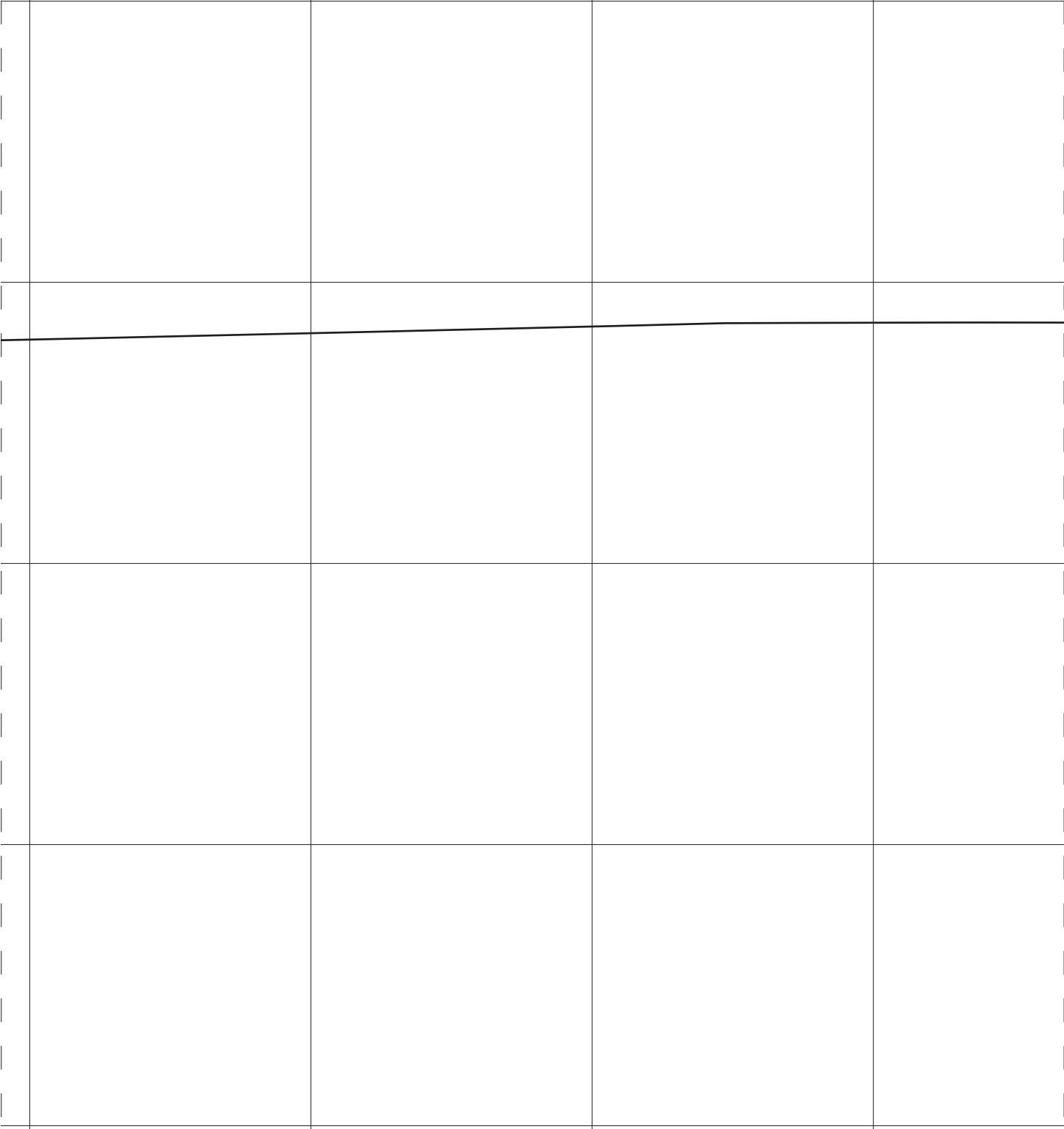

C6

C6



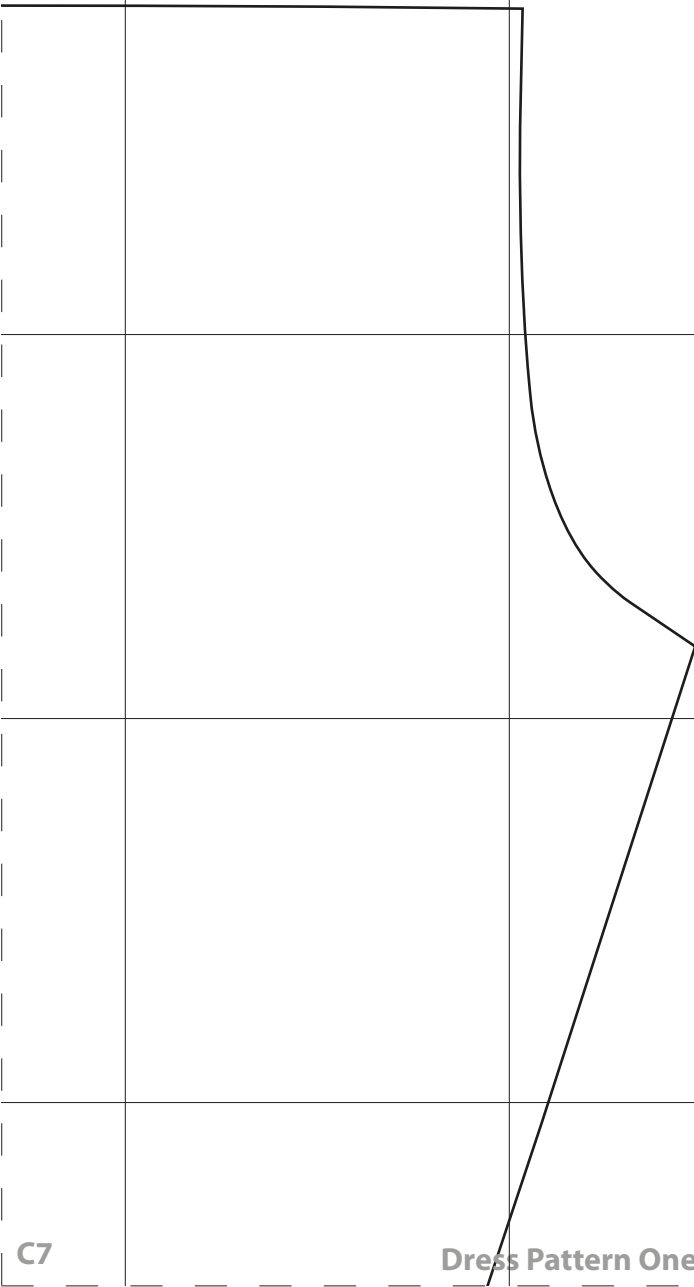

D1

D1

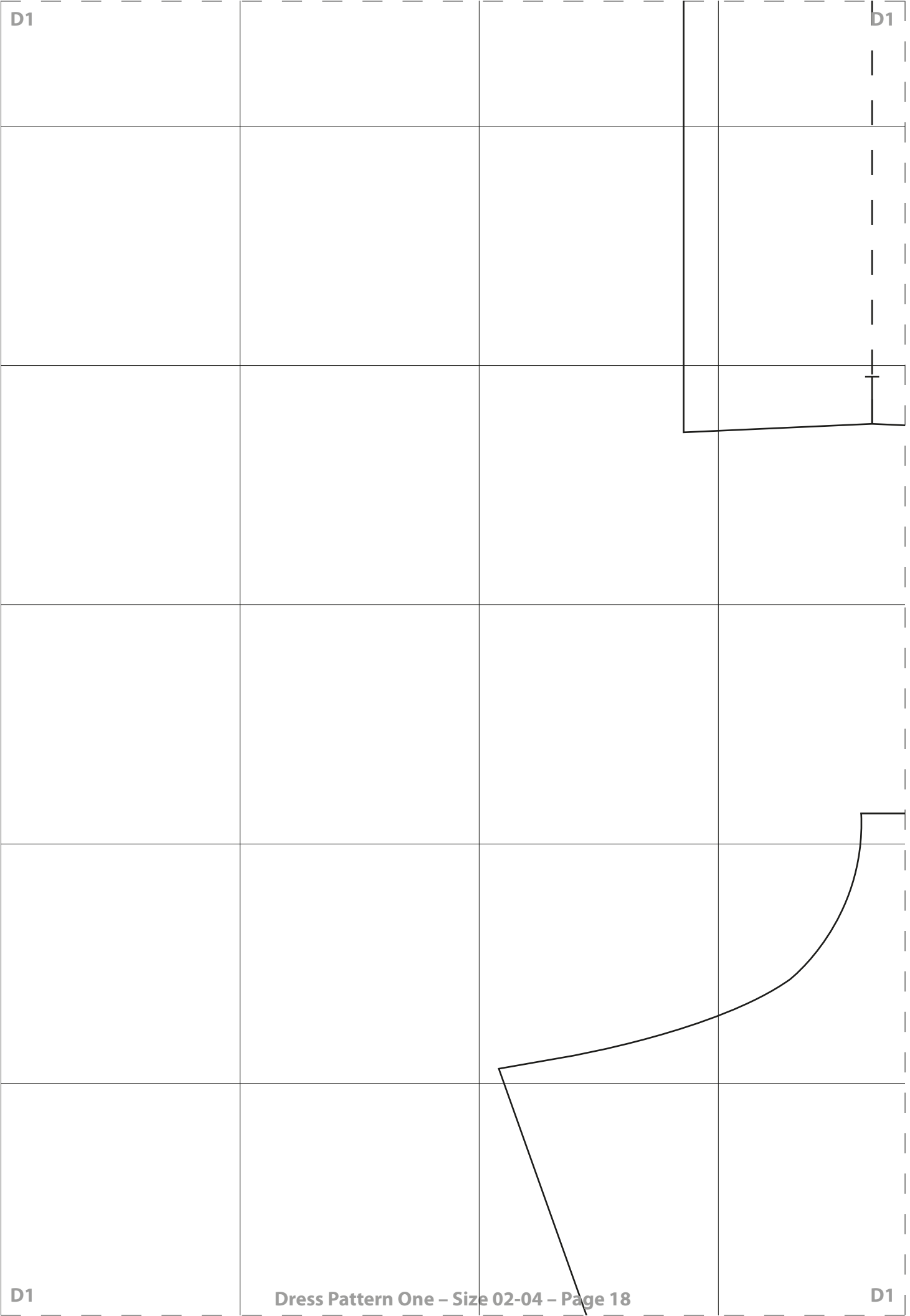

D1

D1

D2

D2



D2

D2

D3

D3

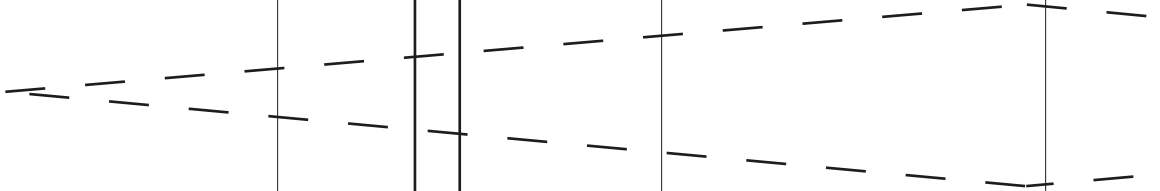

D3

D3

D4

D4

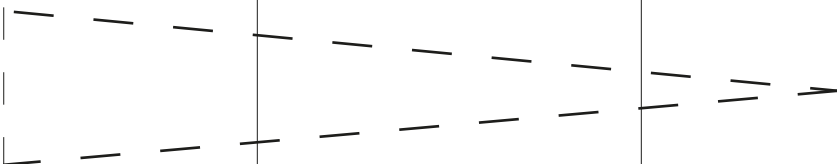
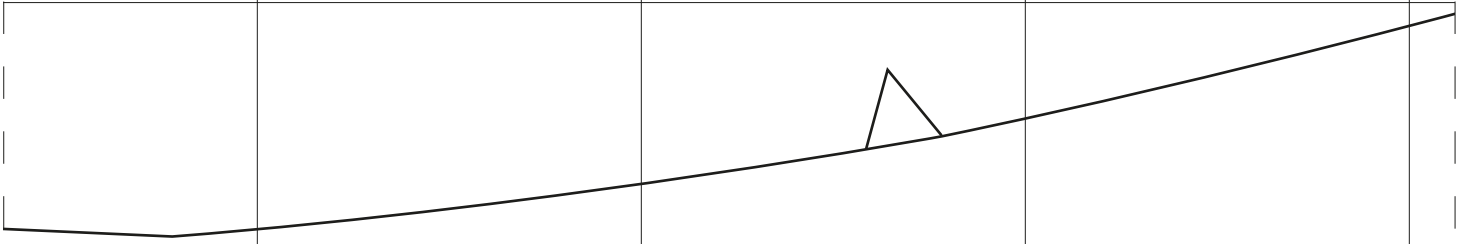

D4

D4

D5

D5

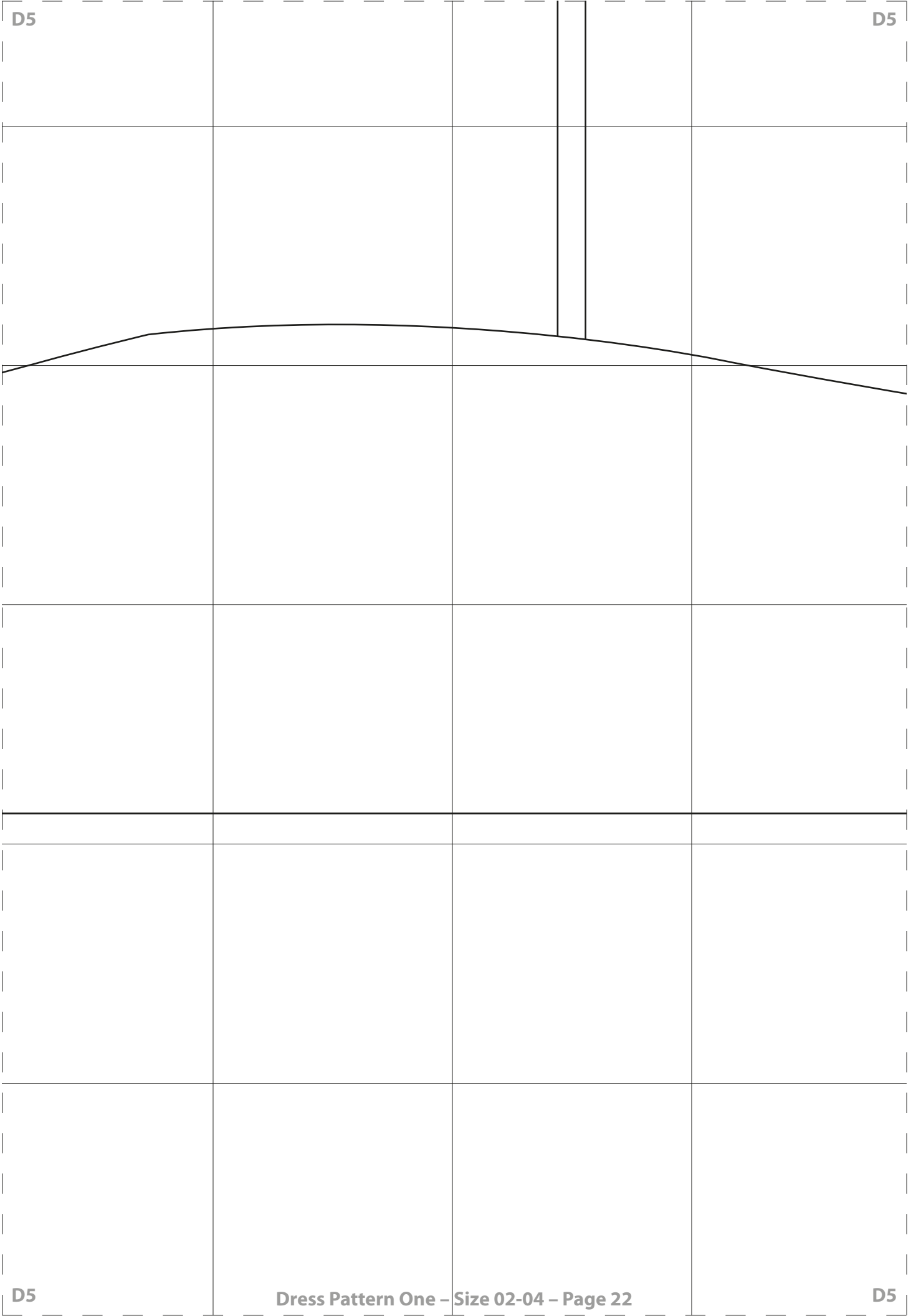

D5

D5

D6

D6

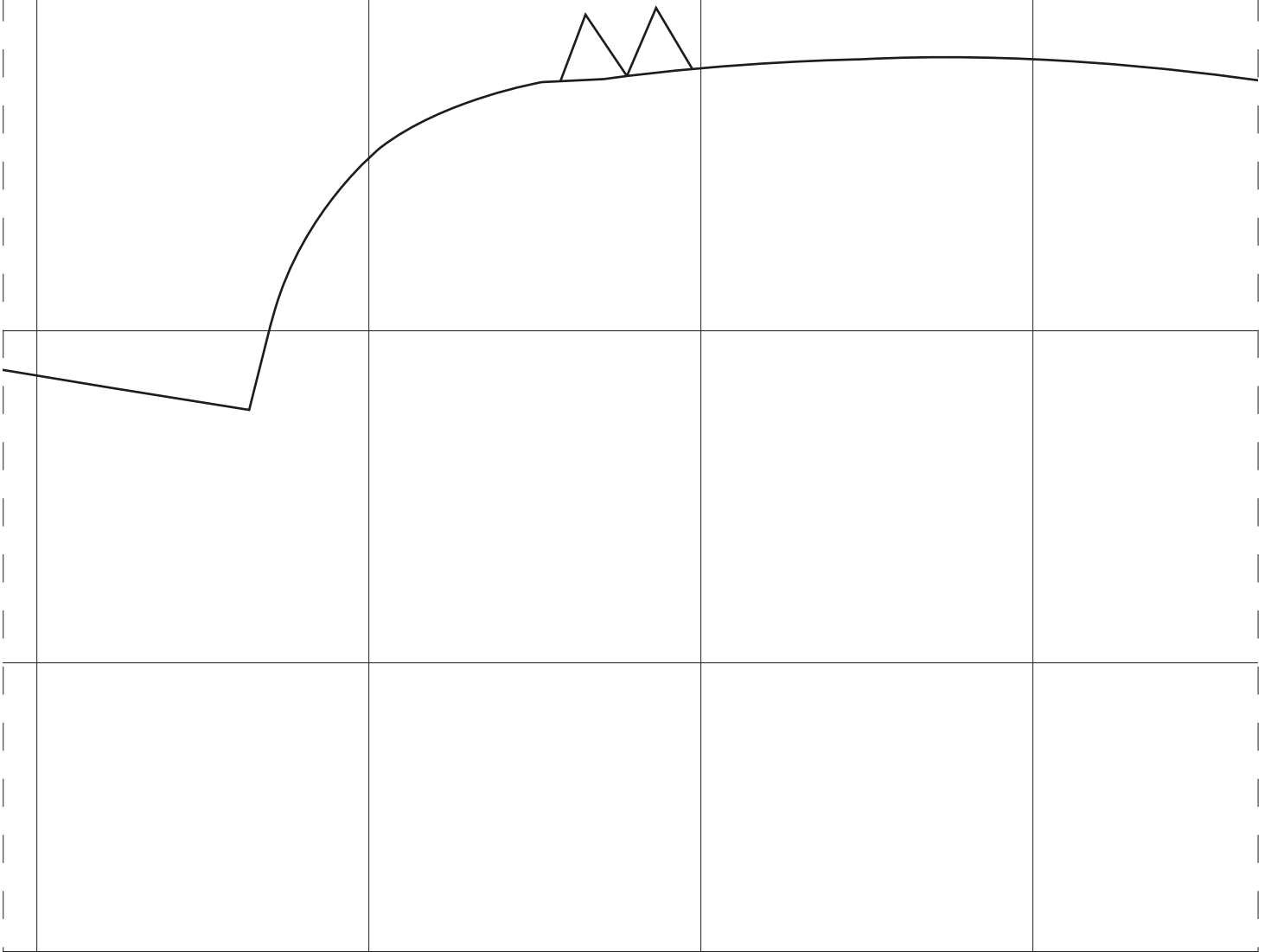

D6

D6





E1

E1

E1

E1

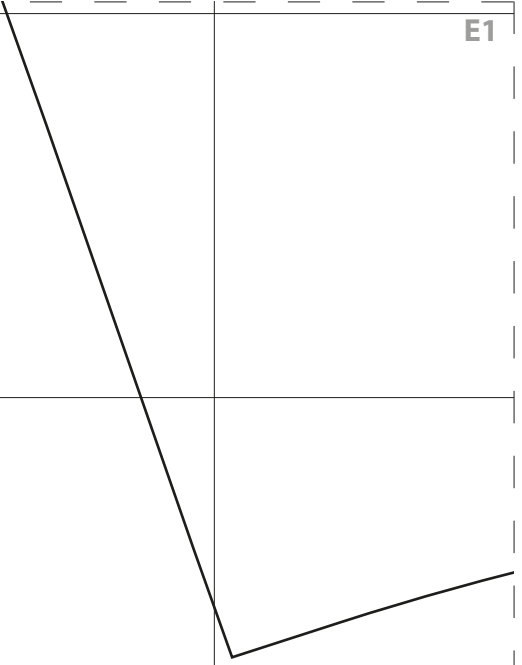

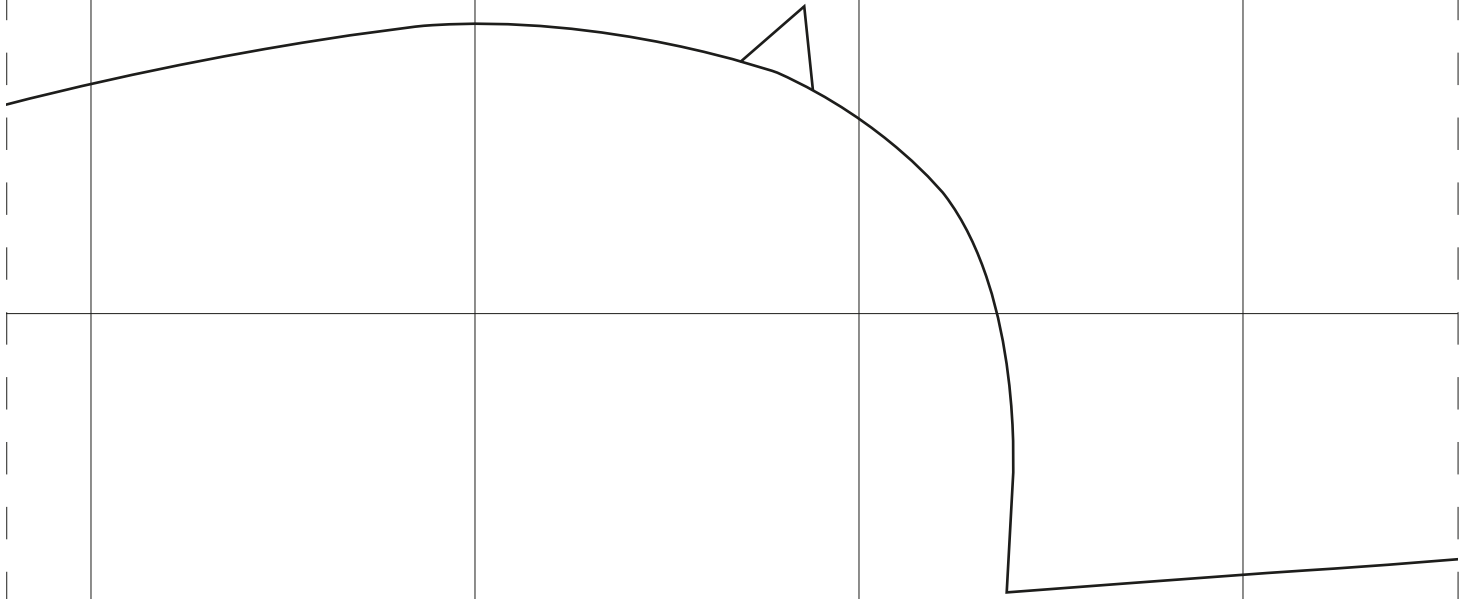

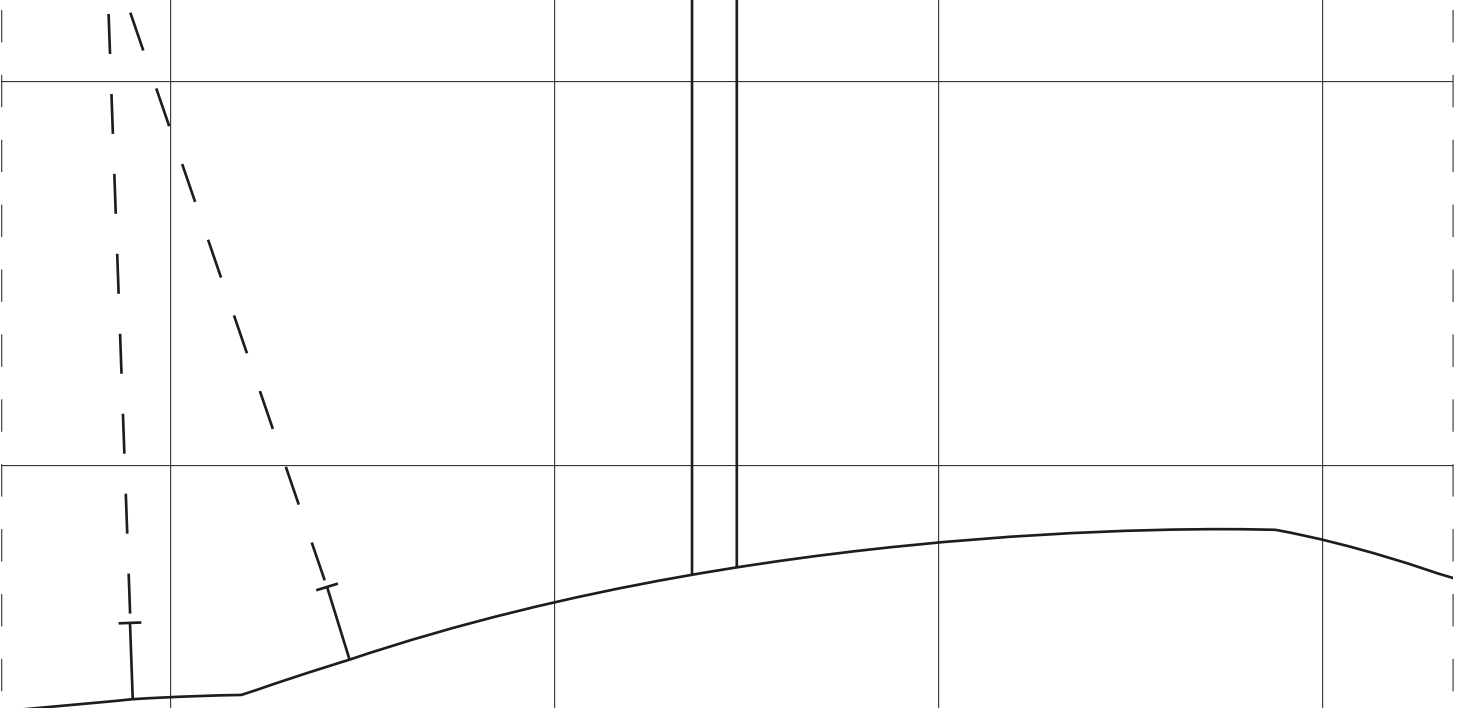

E4

E4

DRESS FRONT  
Cut 1 on folded fabric



E4

E4

E5

E5

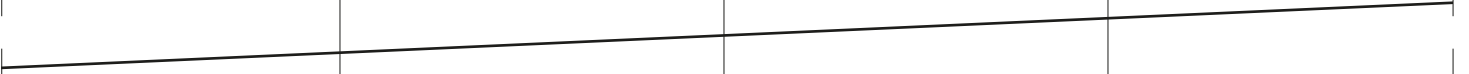

E5

E5

E6

E6

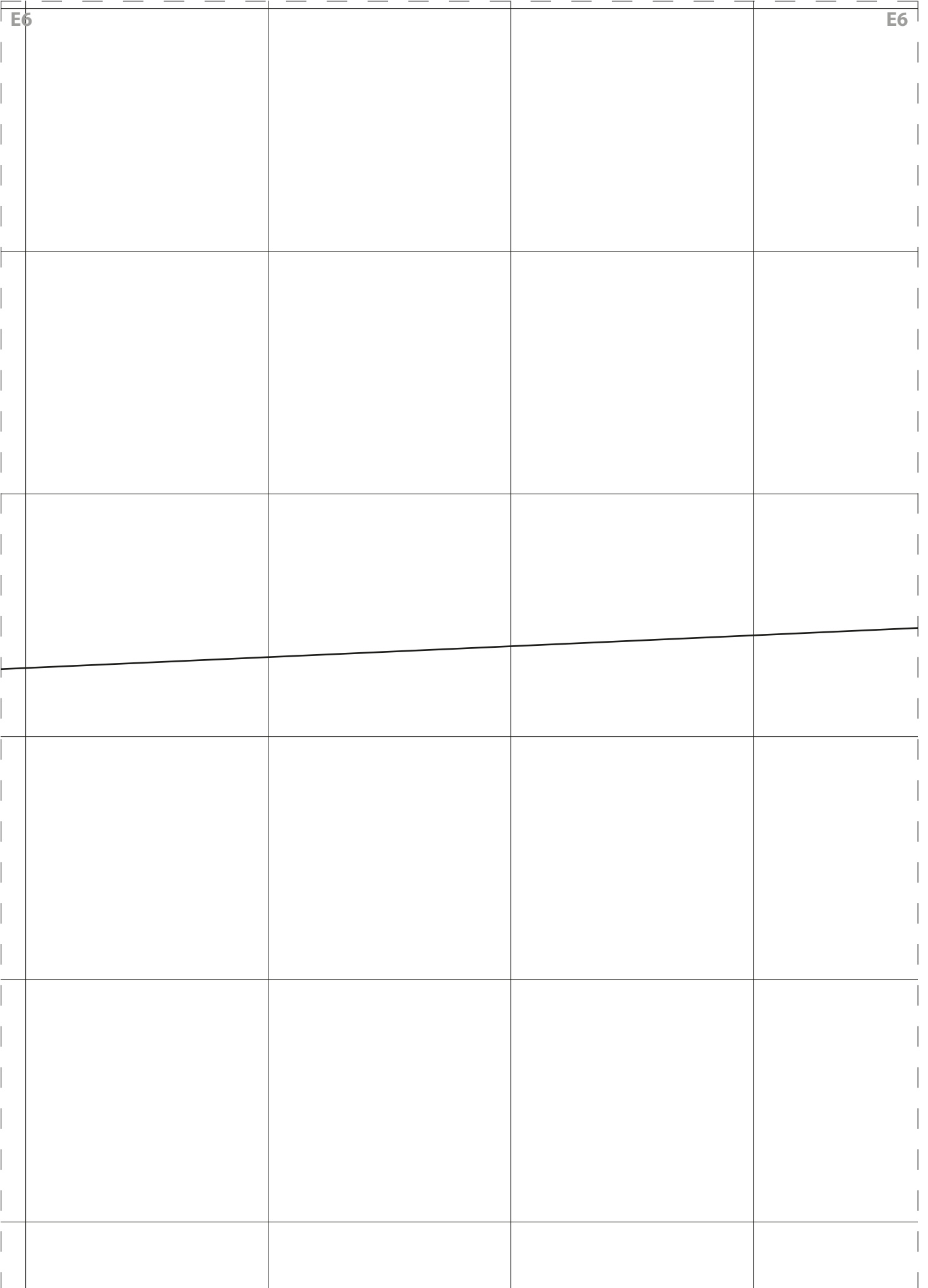

E6

E6

