

A1

A1

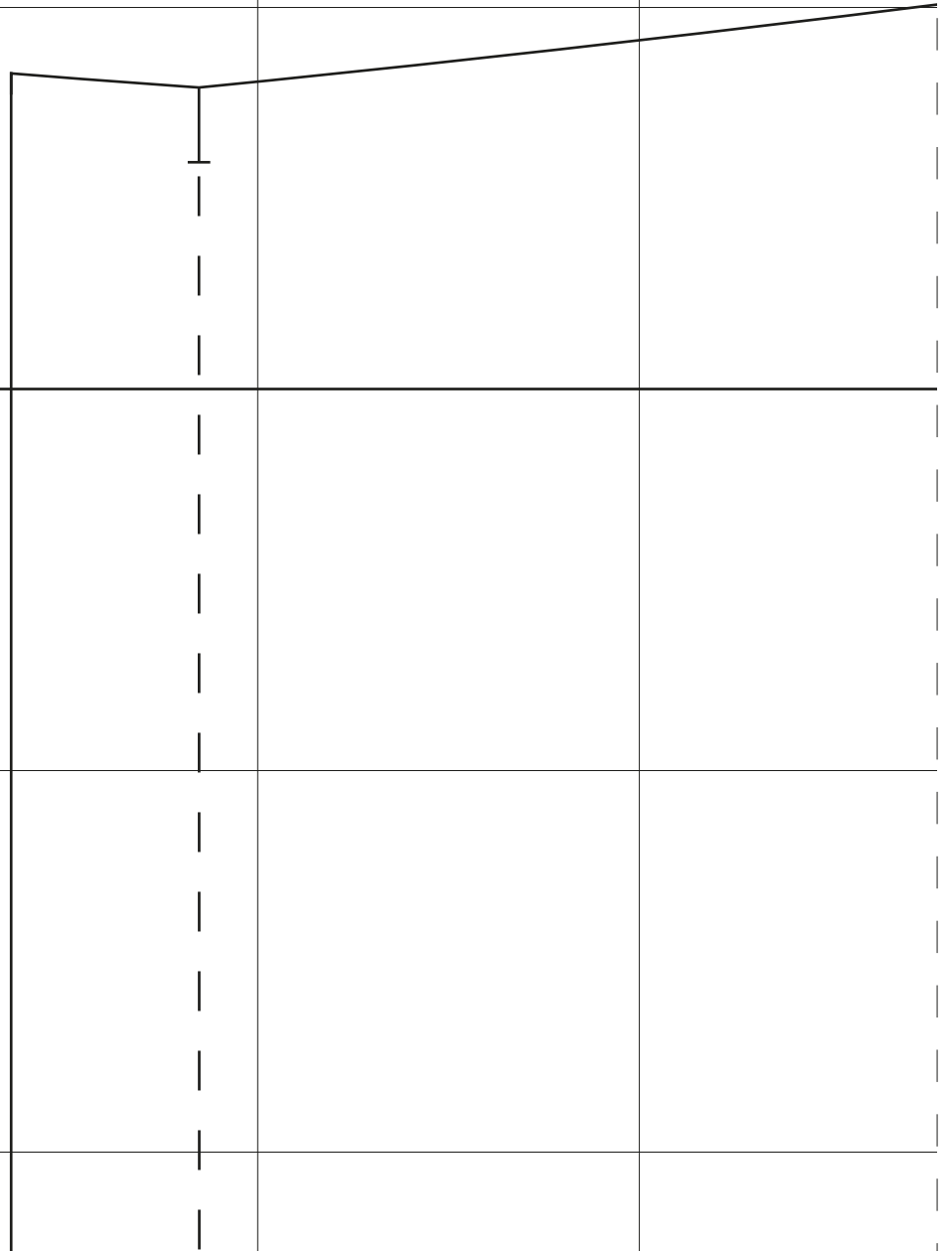

A1

A1

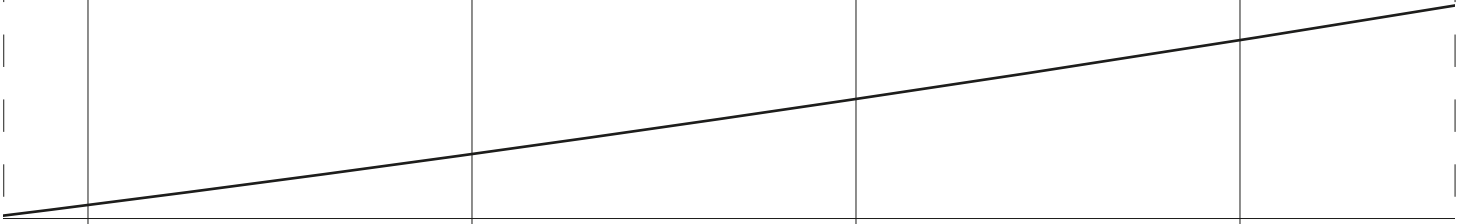

SLEEVE
Cut 2 fabric



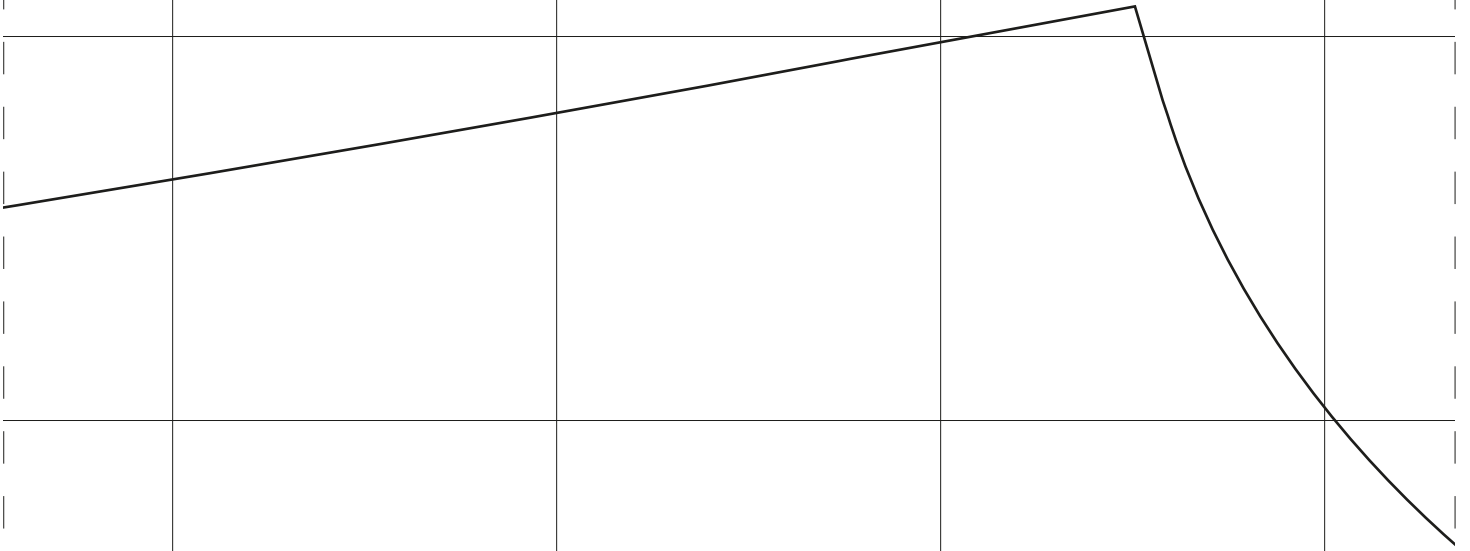

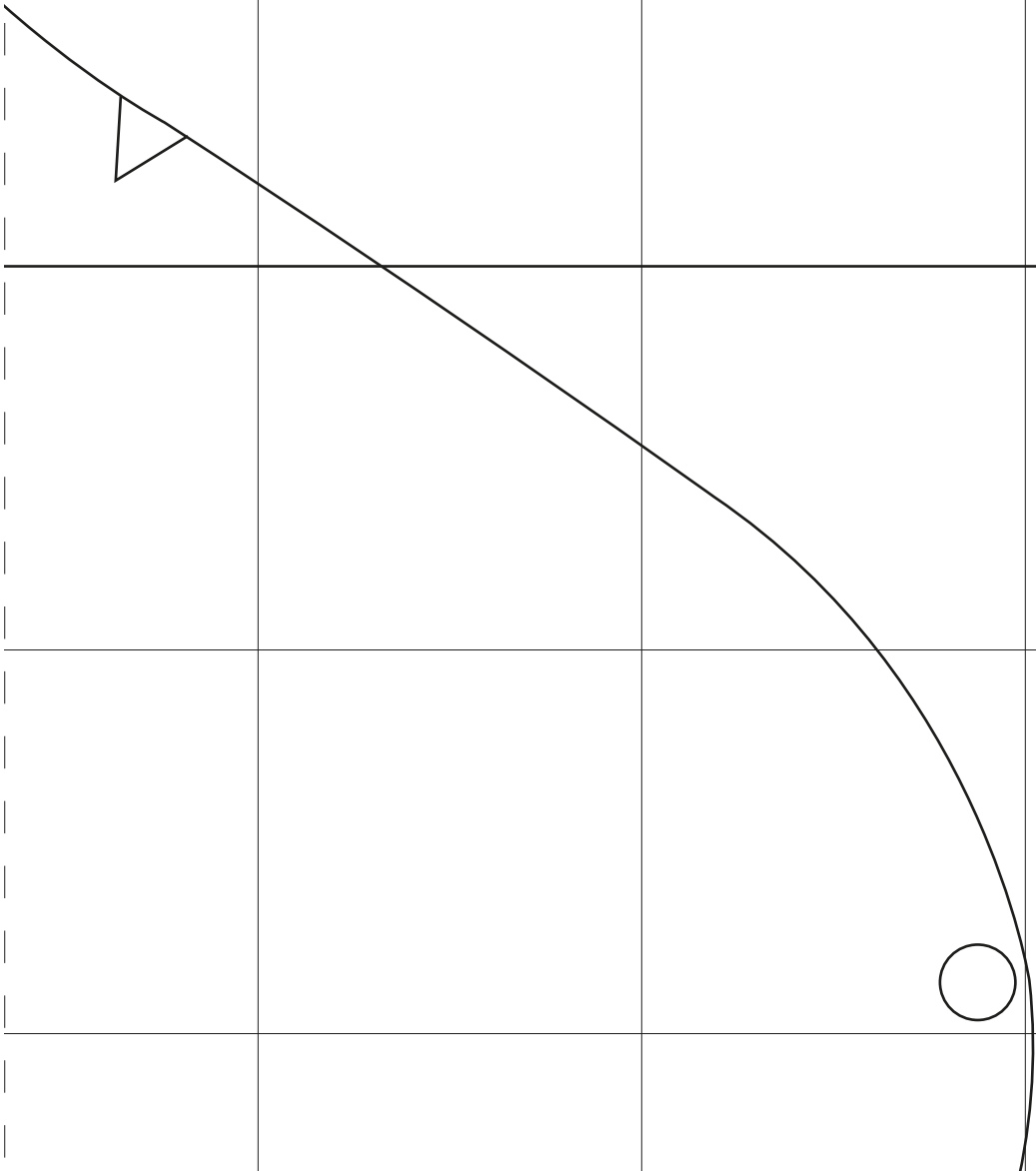

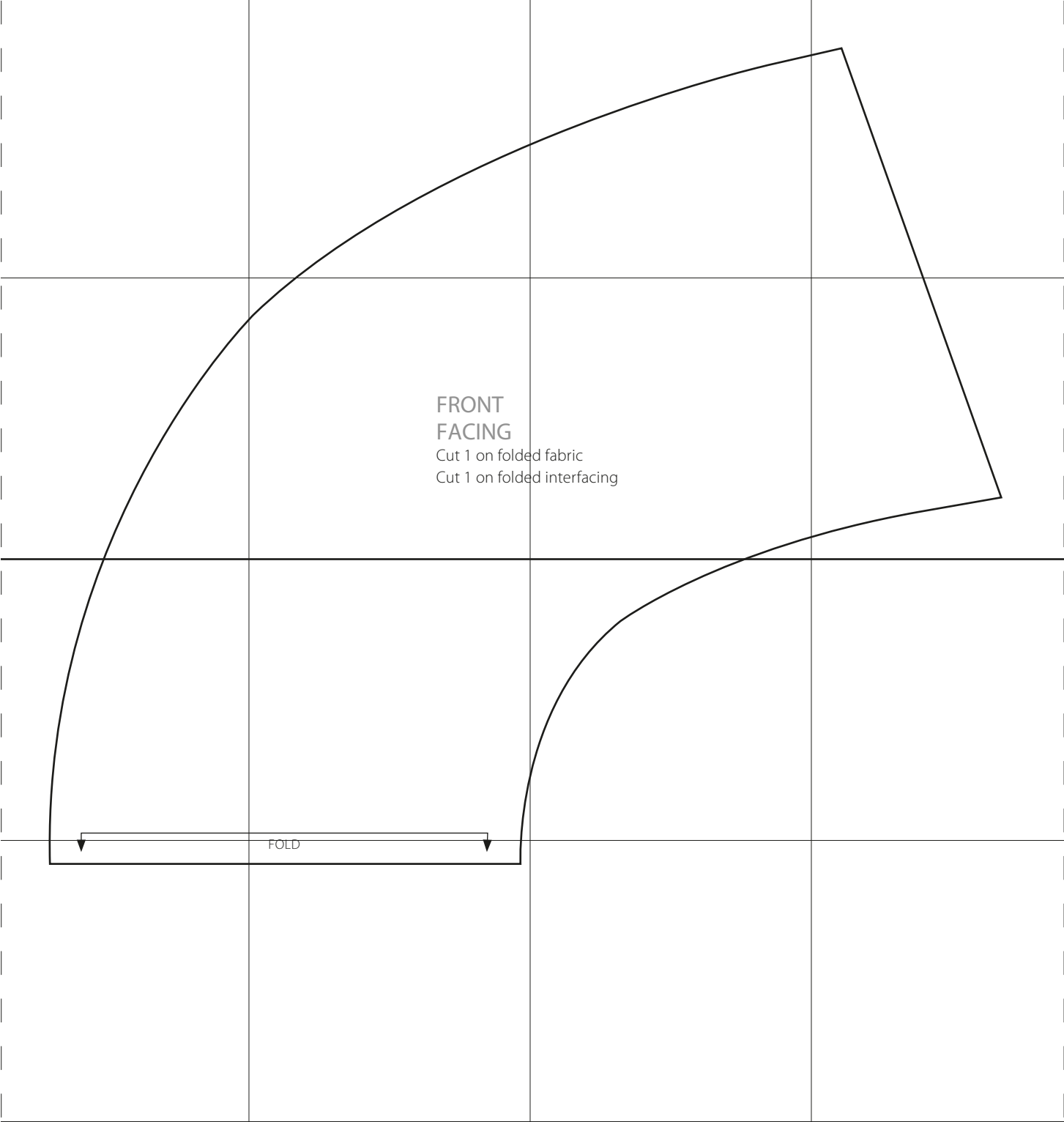

FRONT
FACING
Cut 1 on folded fabric
Cut 1 on folded interfacing

FOLD

B1

B1

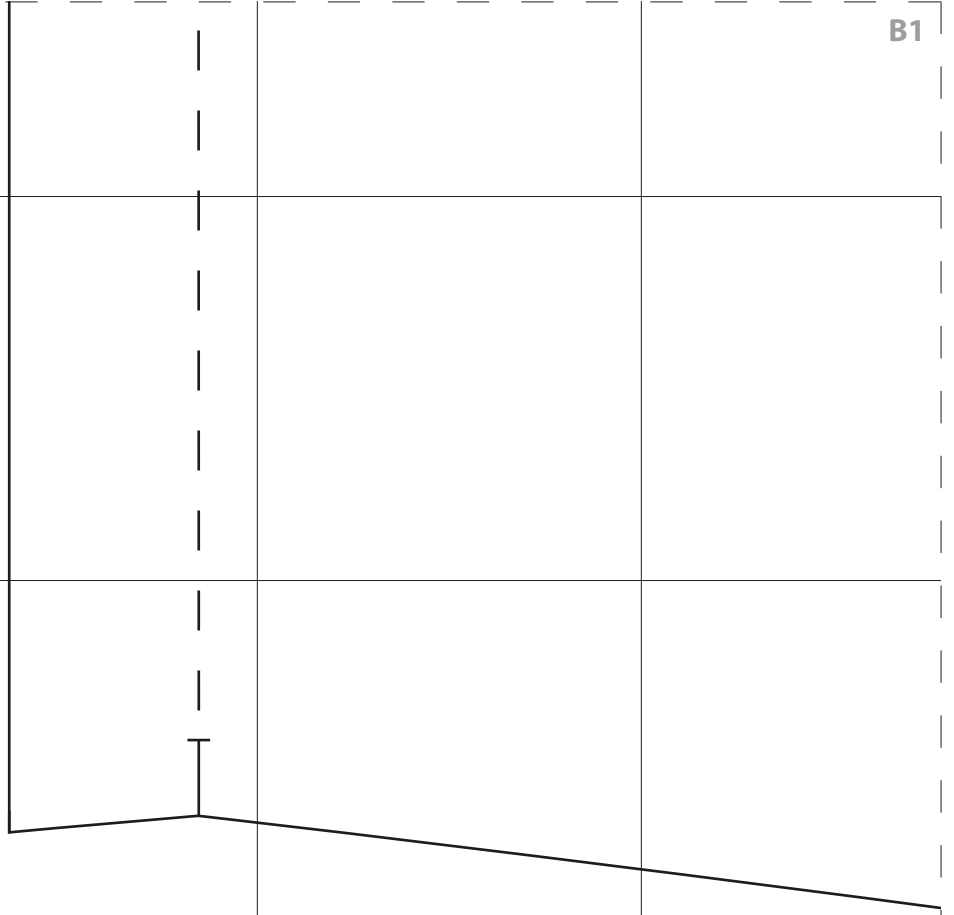

B1

B1

B2

B2

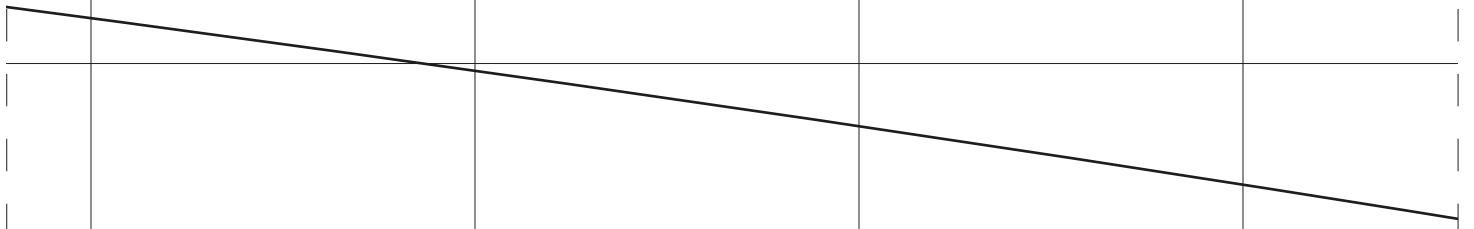

B2

B2

B3

B3

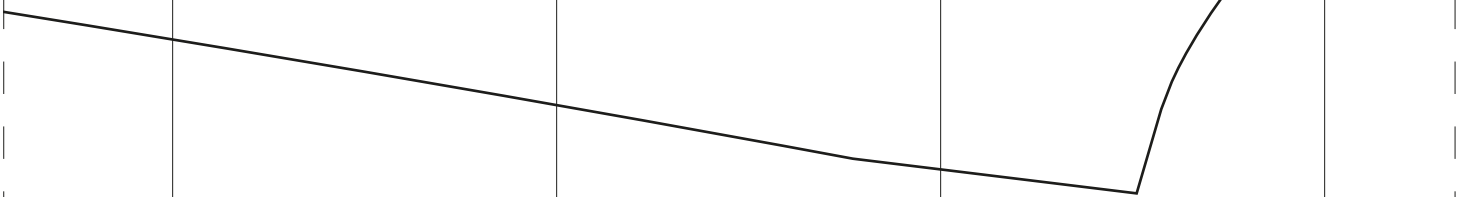

B3

B3

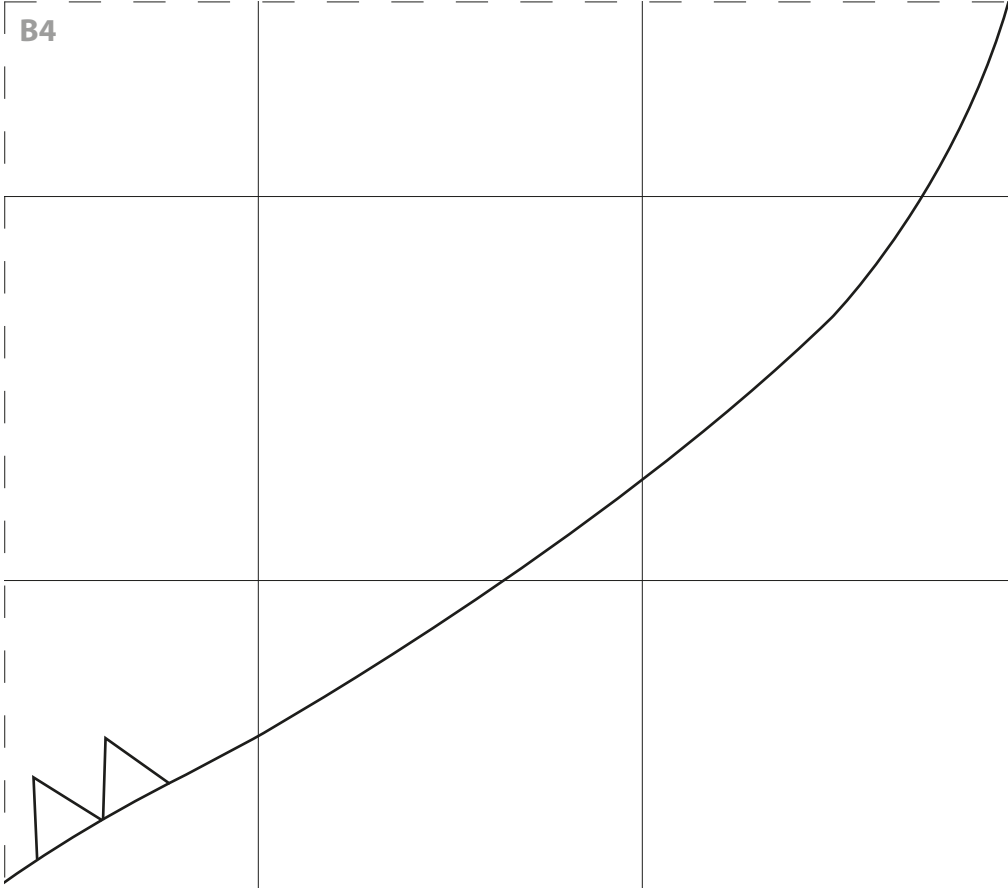

CB

BACK
FACING
Cut 2 fabric
Cut 2 interfacing



C1

C1

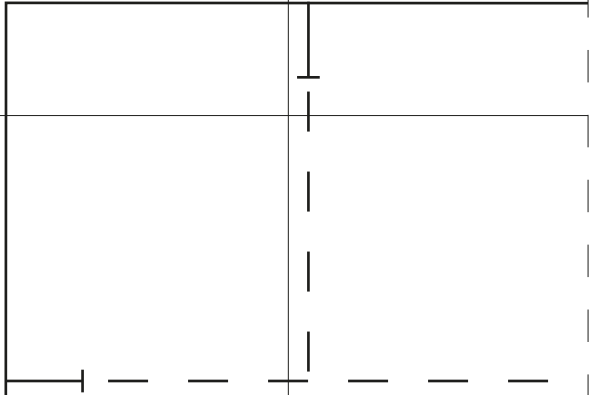

C1

C1

C2

C2

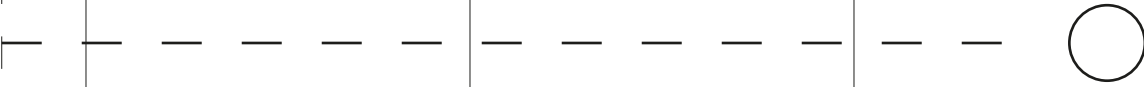

C2

C2

C3

C3

DRESS BACK
Cut 2 fabric



C3

C3

C4

C4

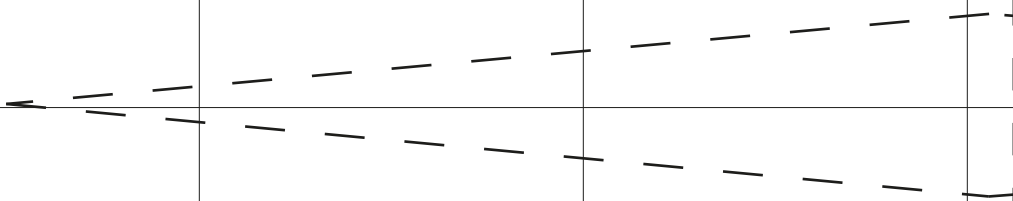

C4

C4

C5

C5

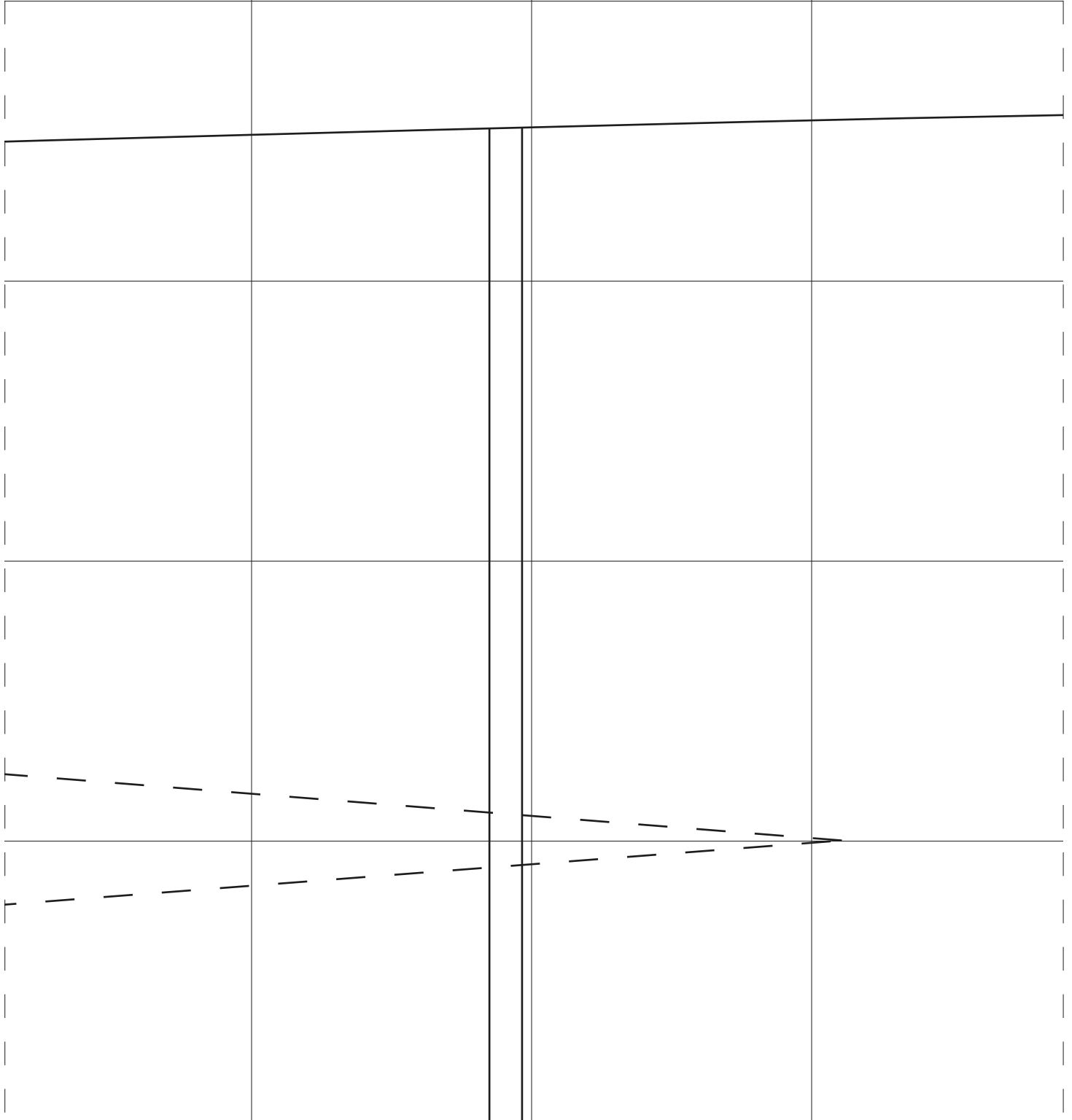

C5

C5

C6

C6



C6

C6

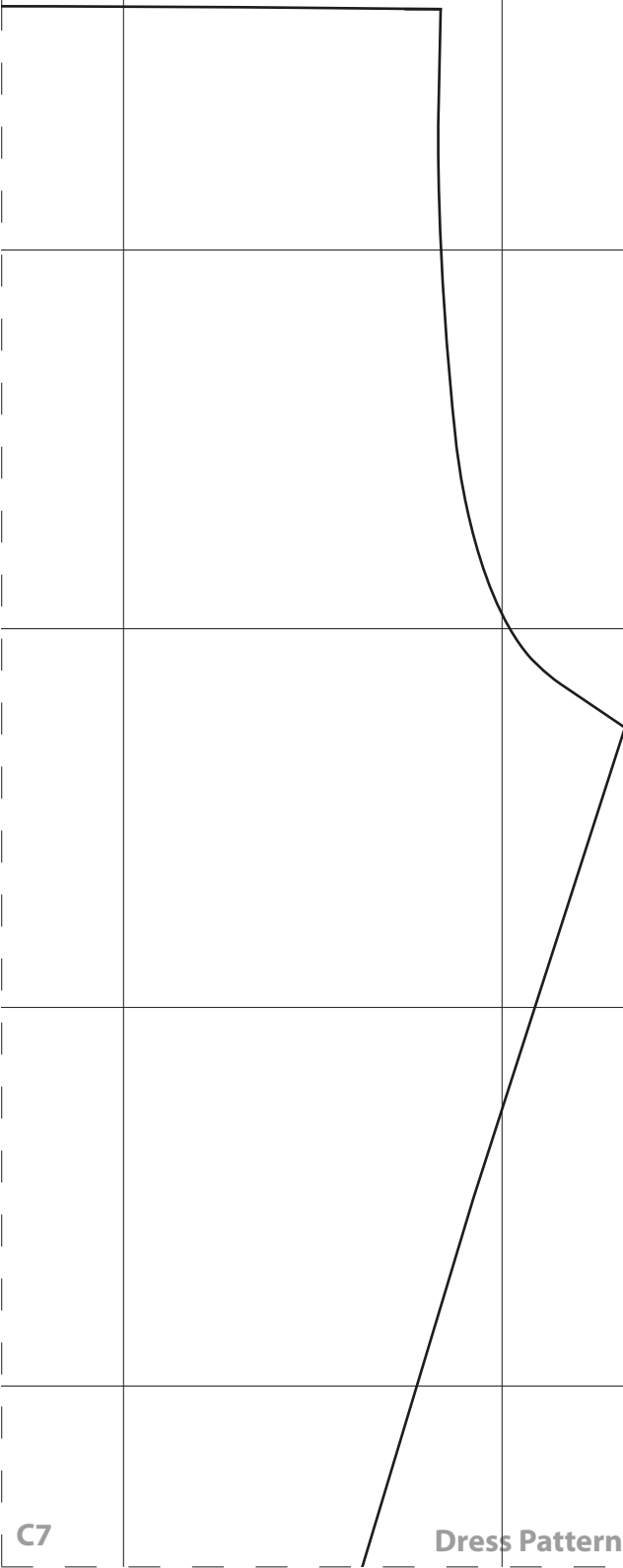

D1

D1

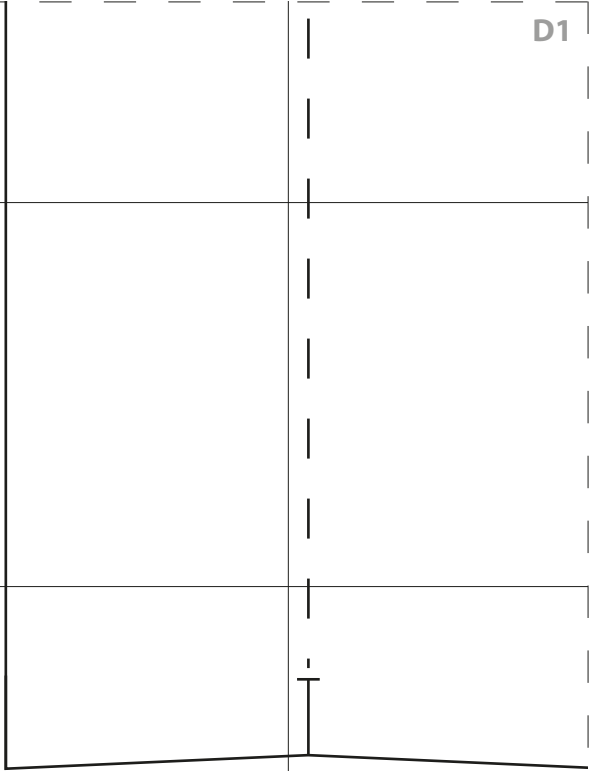

D1

D1

D2

D2



D2

D2

D3

D3



D3

D3

D4

D4

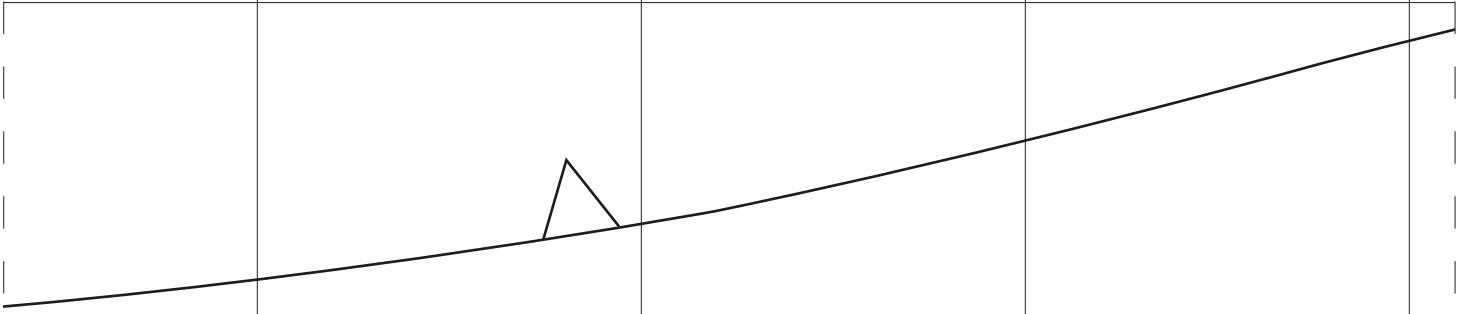

D4

D4

D5

D5

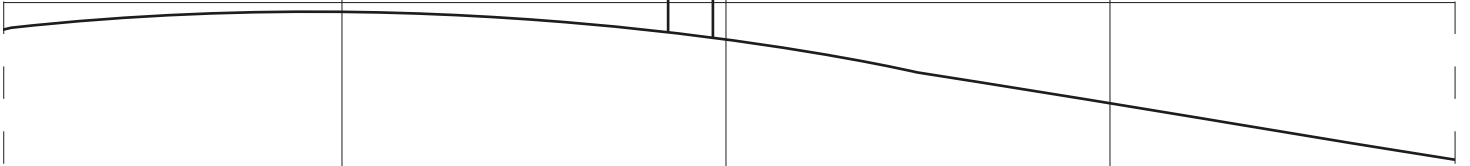

D5

D5

D6

D6

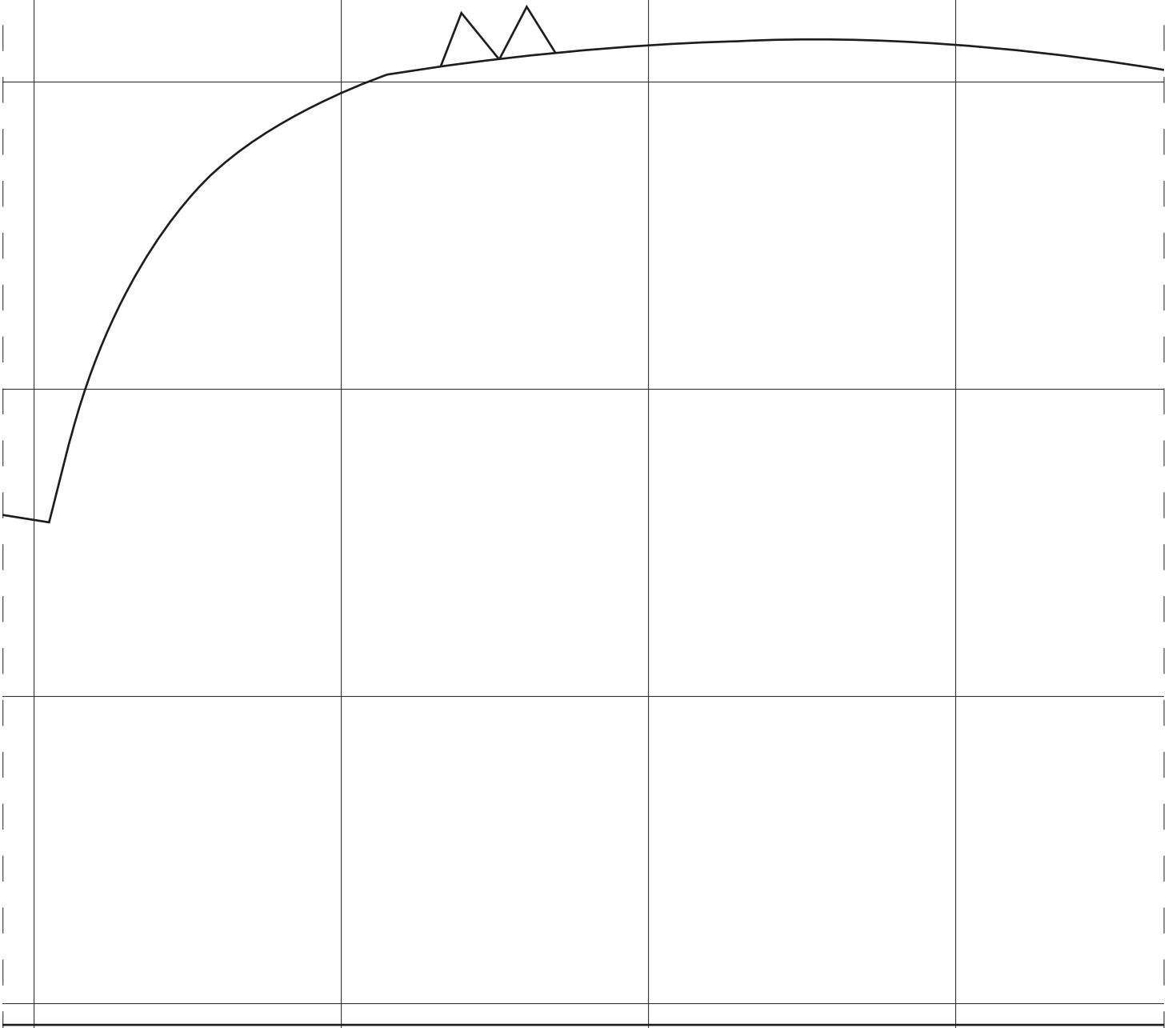

D6

D6

D7

D7

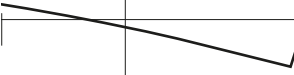

D7

D7

E1

E1

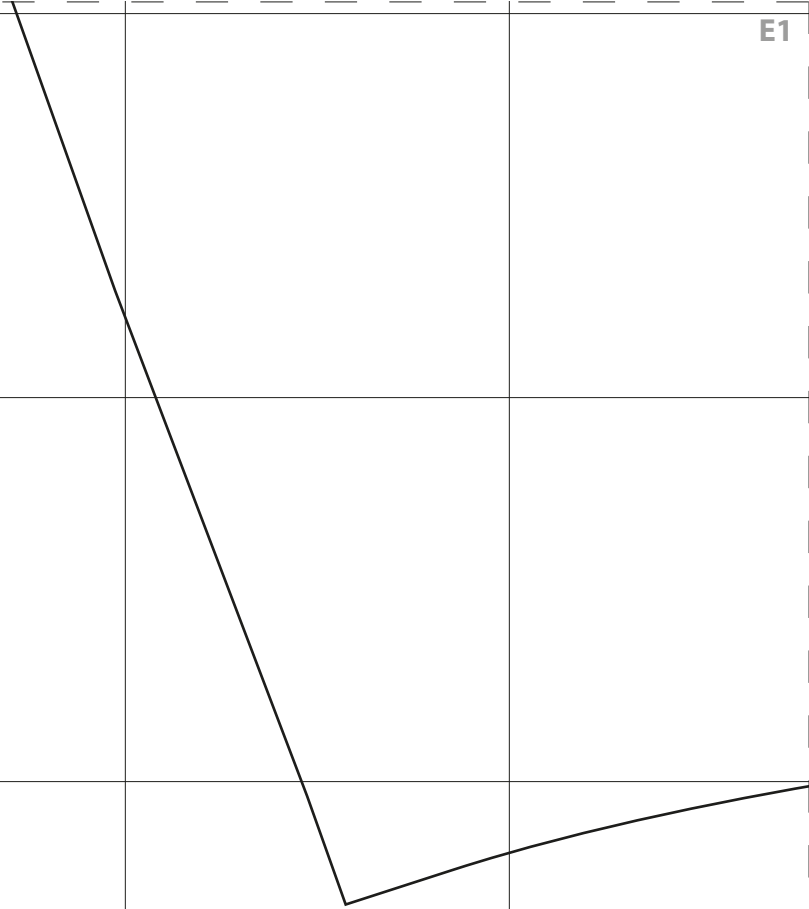

E1

E1

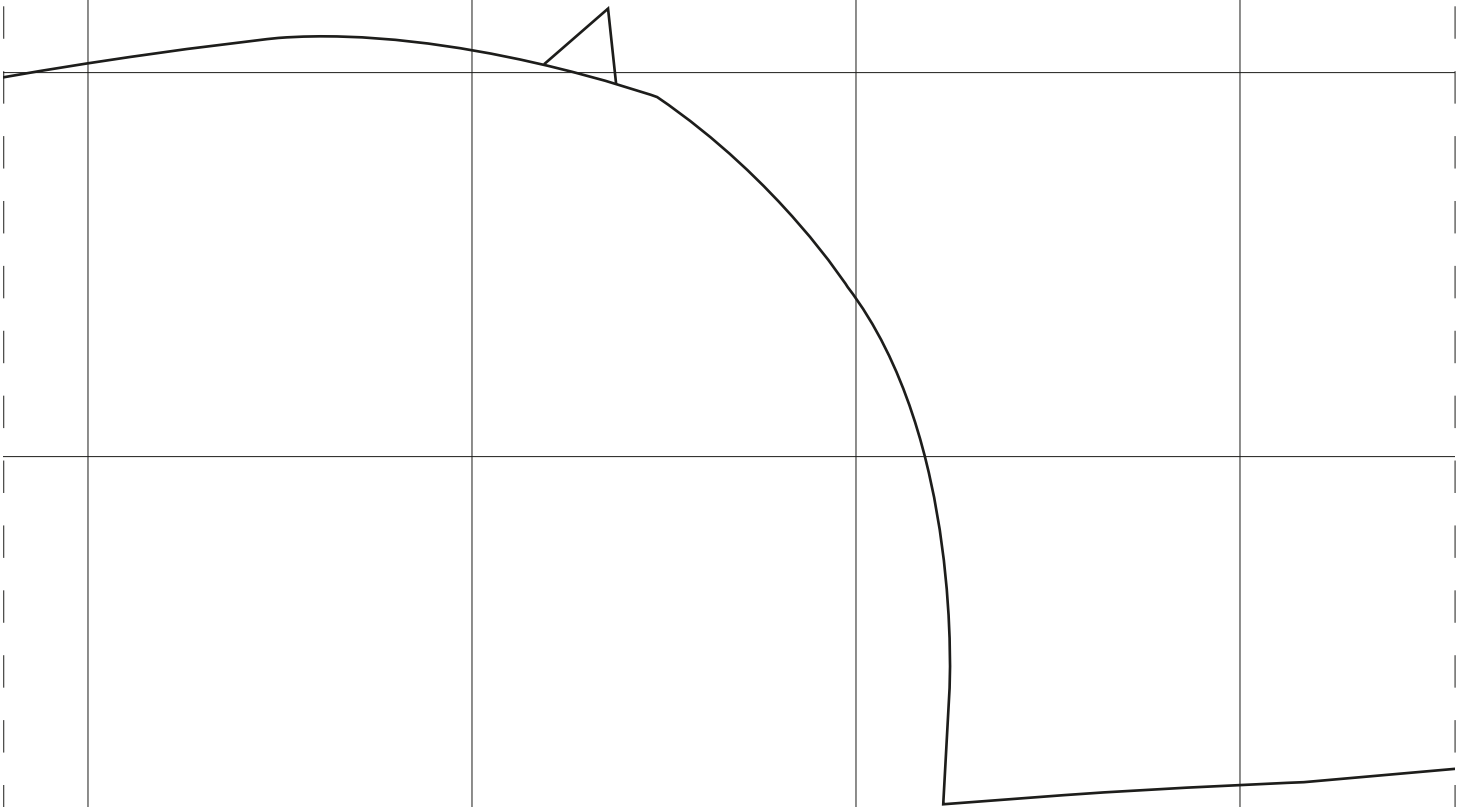

E3

E3

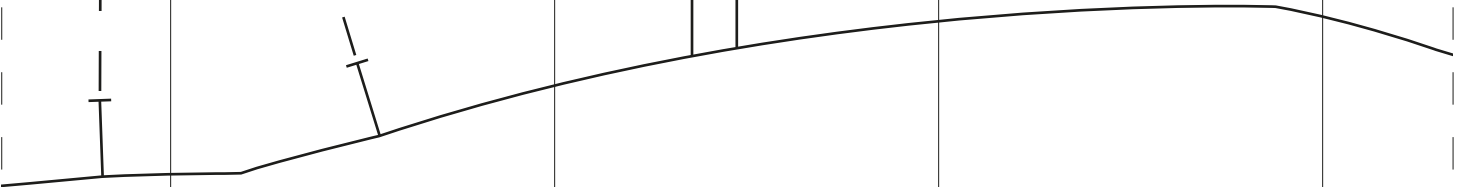
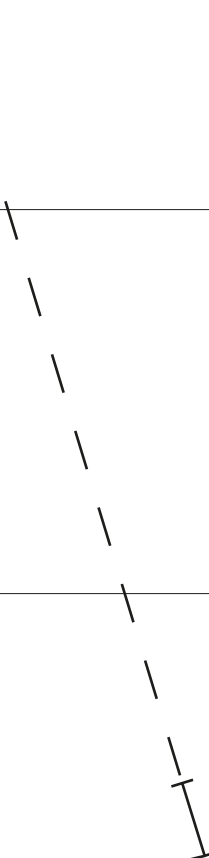
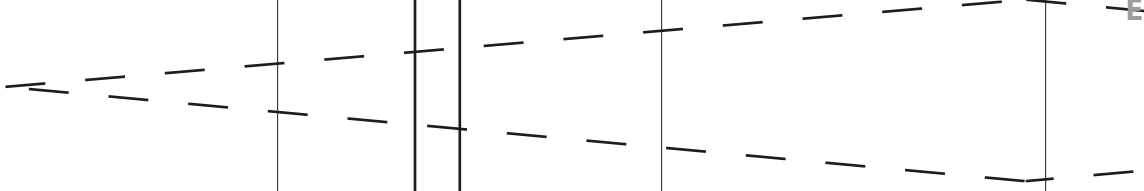

E3

E3

E4

E4

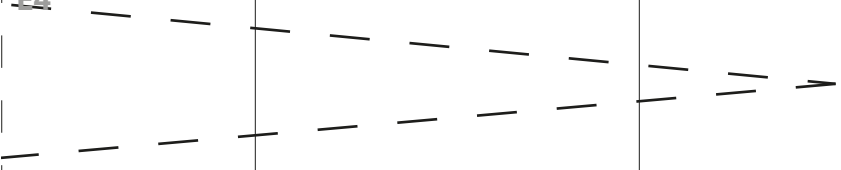

DRESS FRONT
 Cut 1 on folded fabric

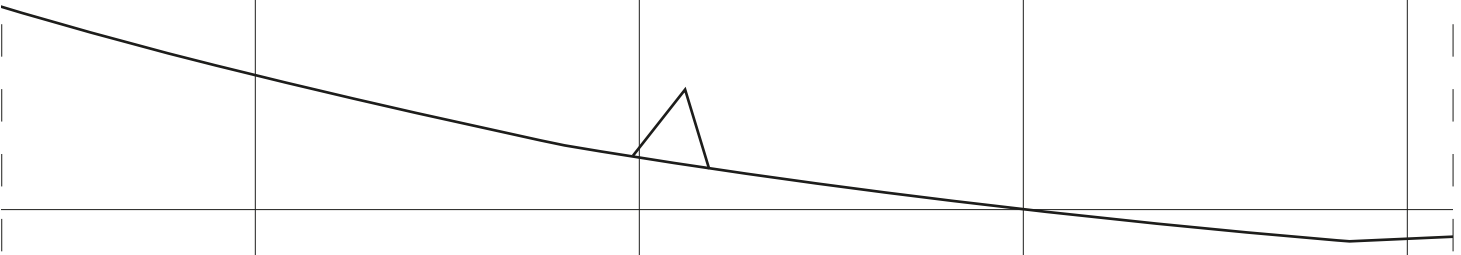

E4

E4

E5

E5

E5

E5

E6

E6

E6

E6

