

A1

A1

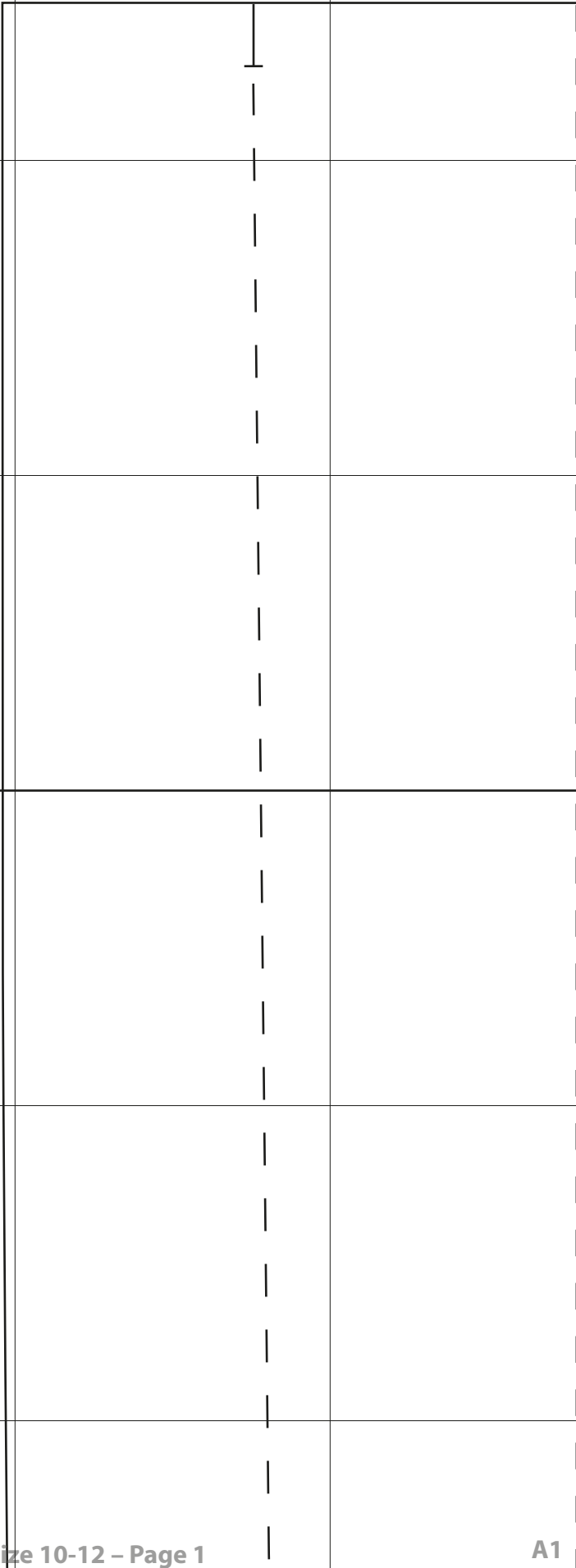

A1

A1

A2

A2

CB

SKIRT BACK
Cut 2 fabric



A2

A2



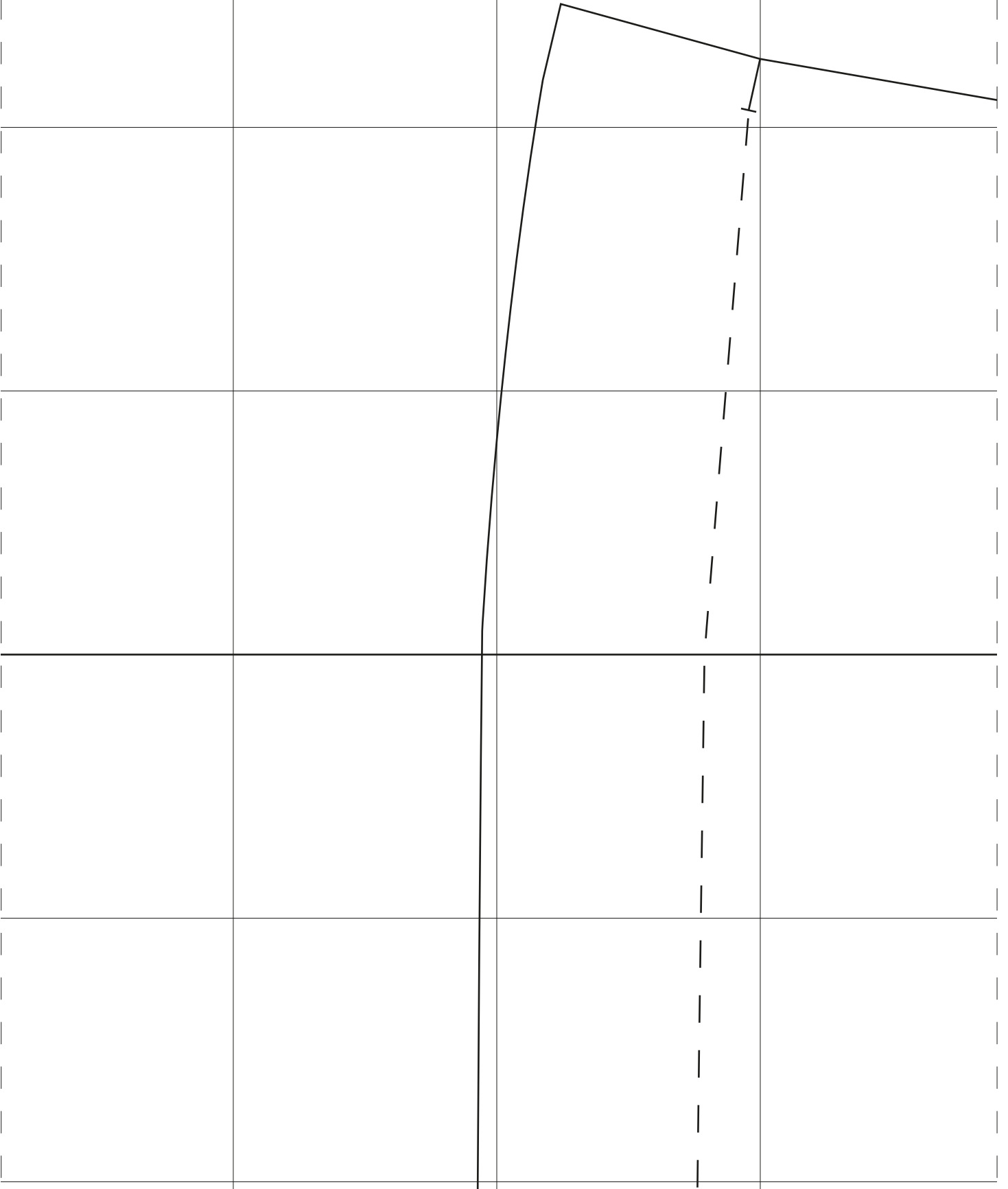

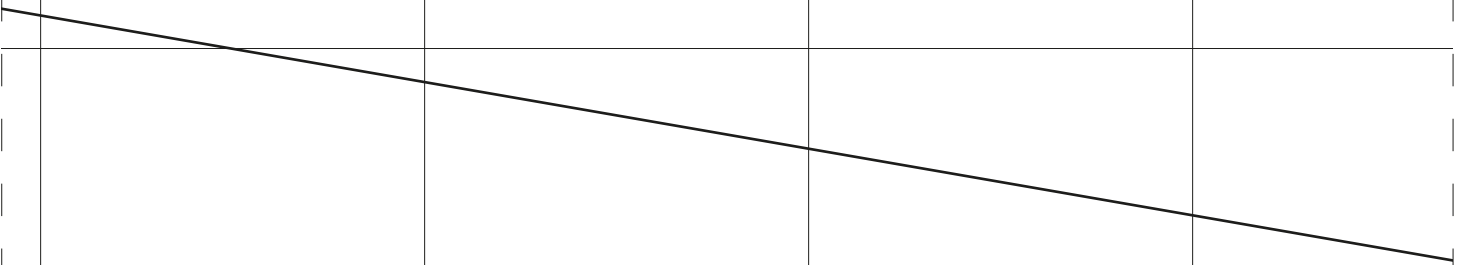

SKIRT FRONT
Cut 1 on folded fabric

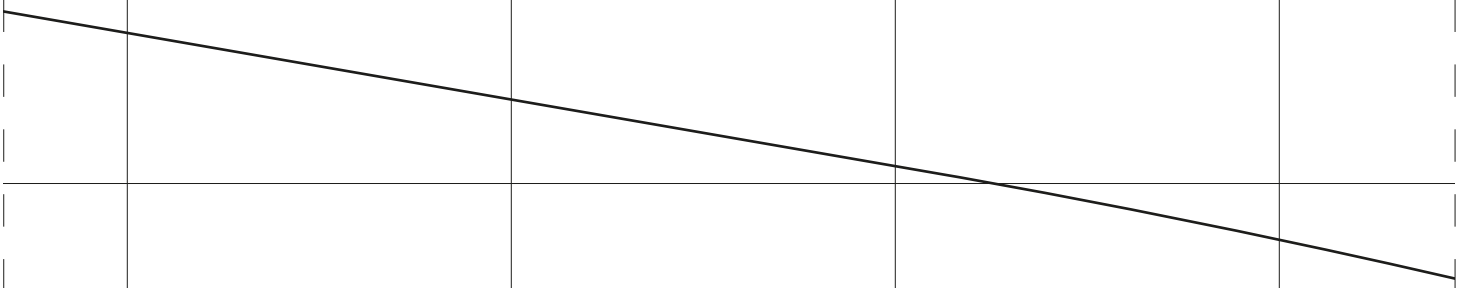

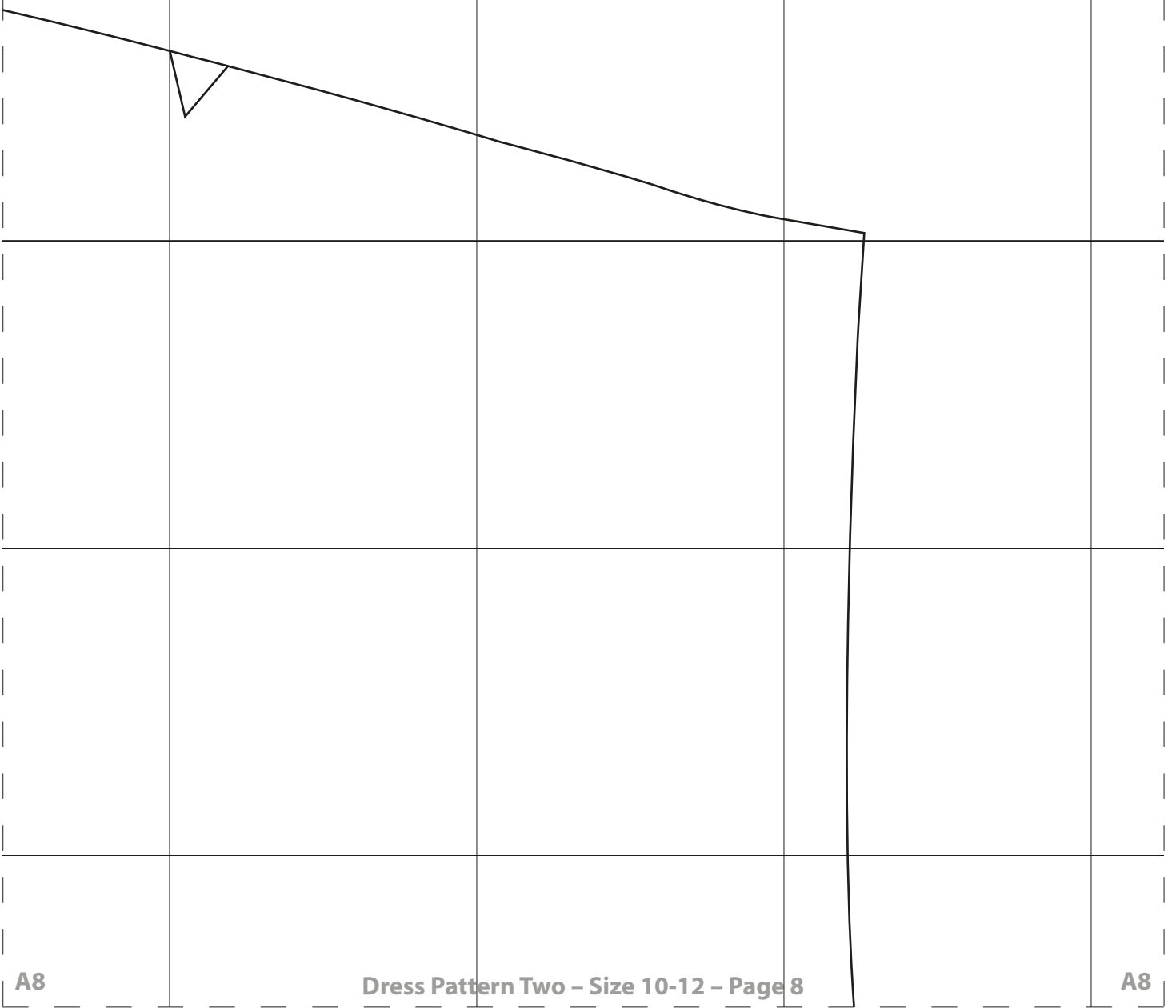

B1

B1

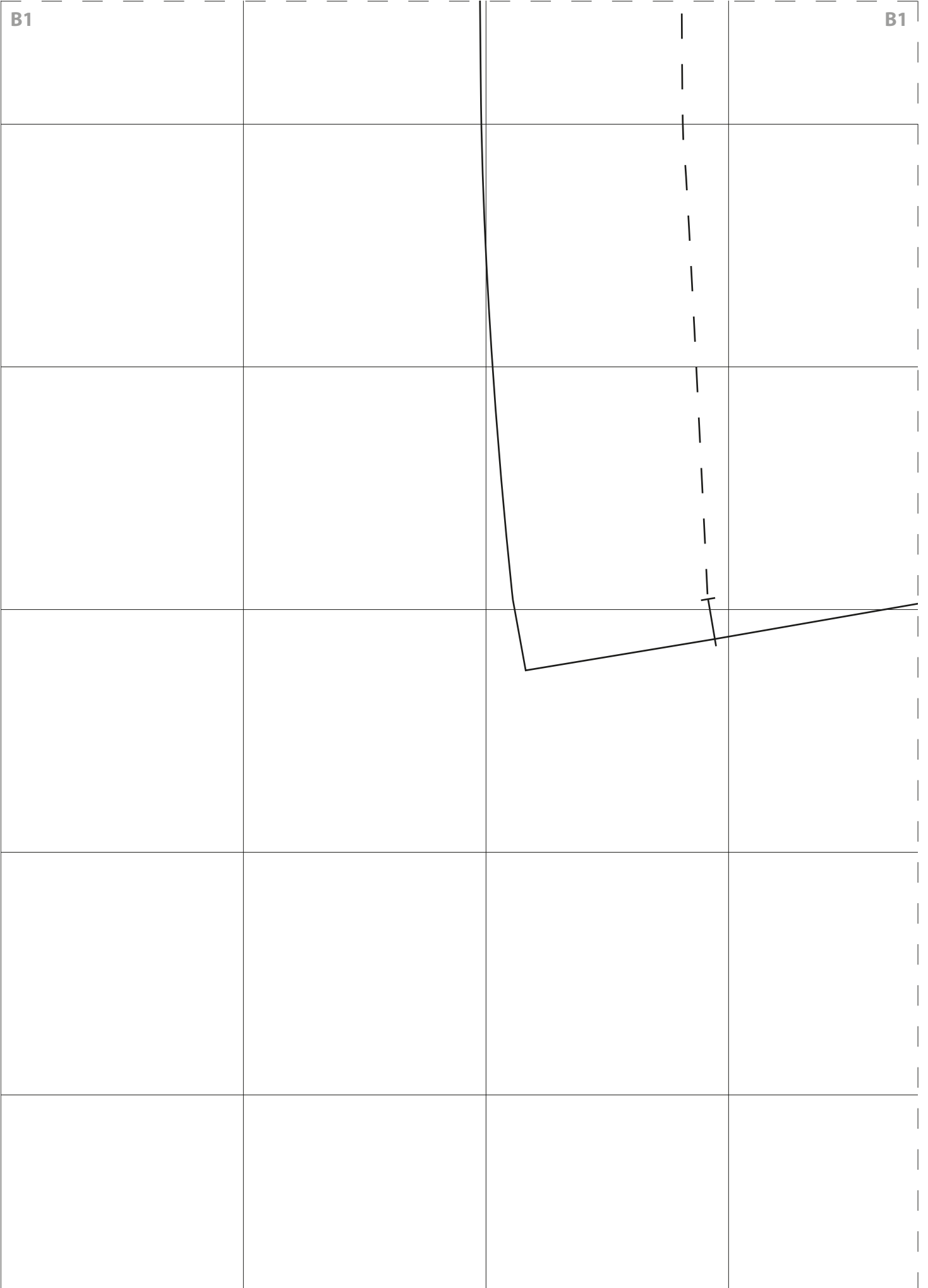

B1

B1

B2

B2

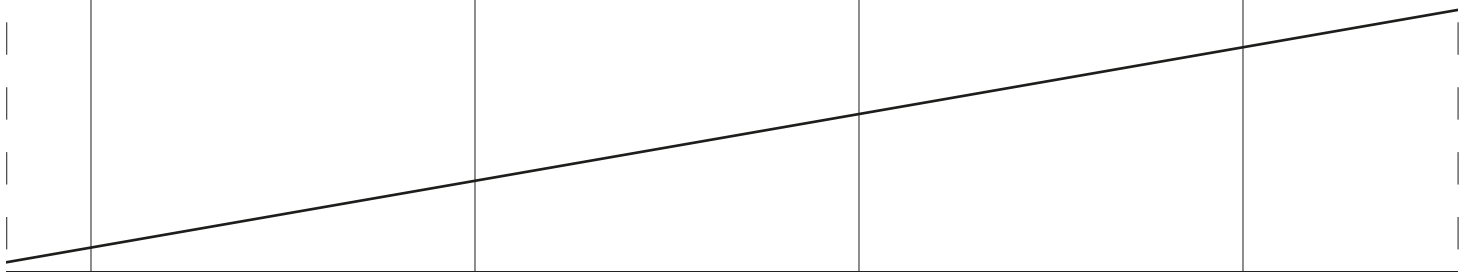

B2

B2

B3

B3

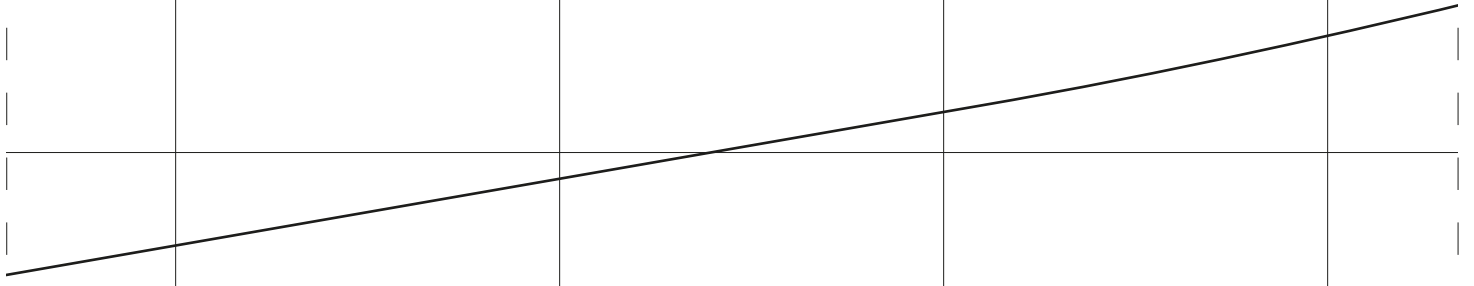

B3

B3

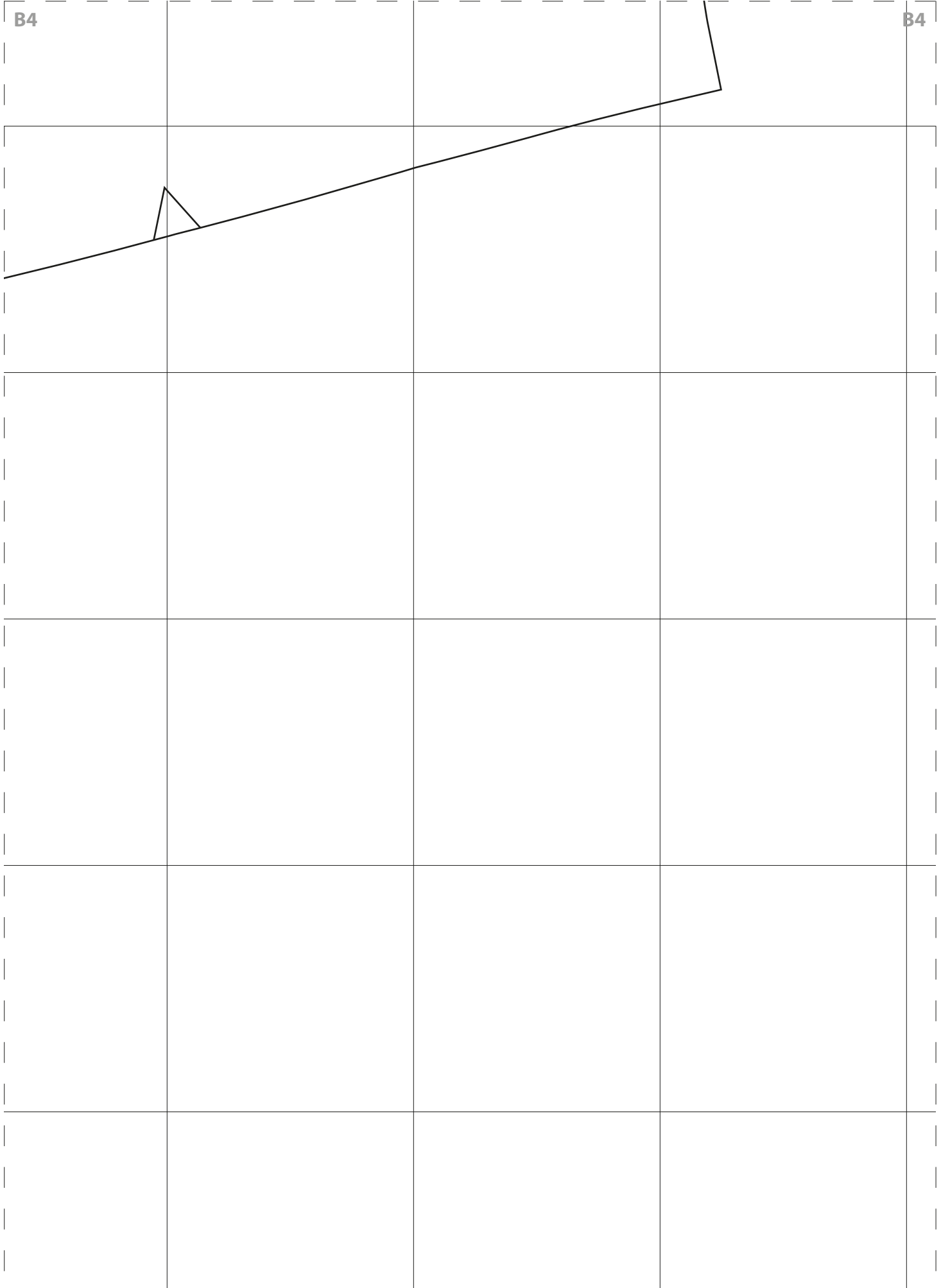

B5

B5

B5

B5

B6

B6



B6

B6

B8

B8

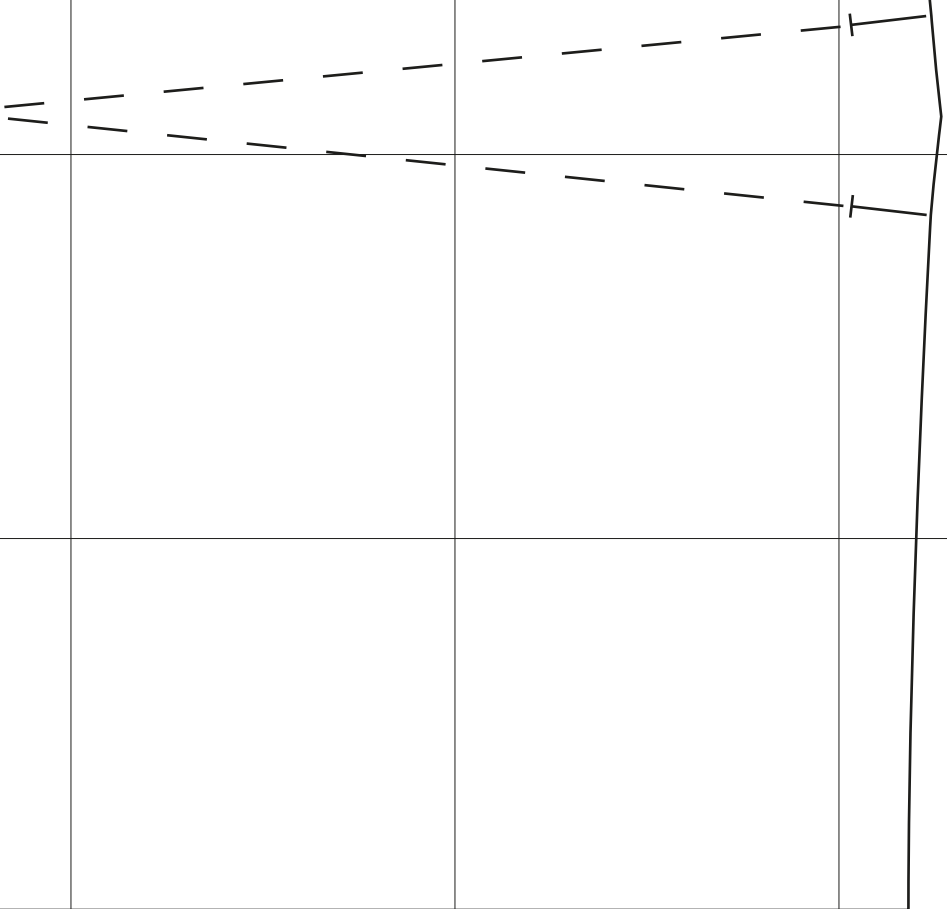

B8

B8

C2

C2

CB

BODICE BACK
Cut 2 fabric

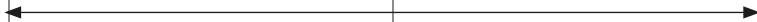

C2

C2

C3

C3

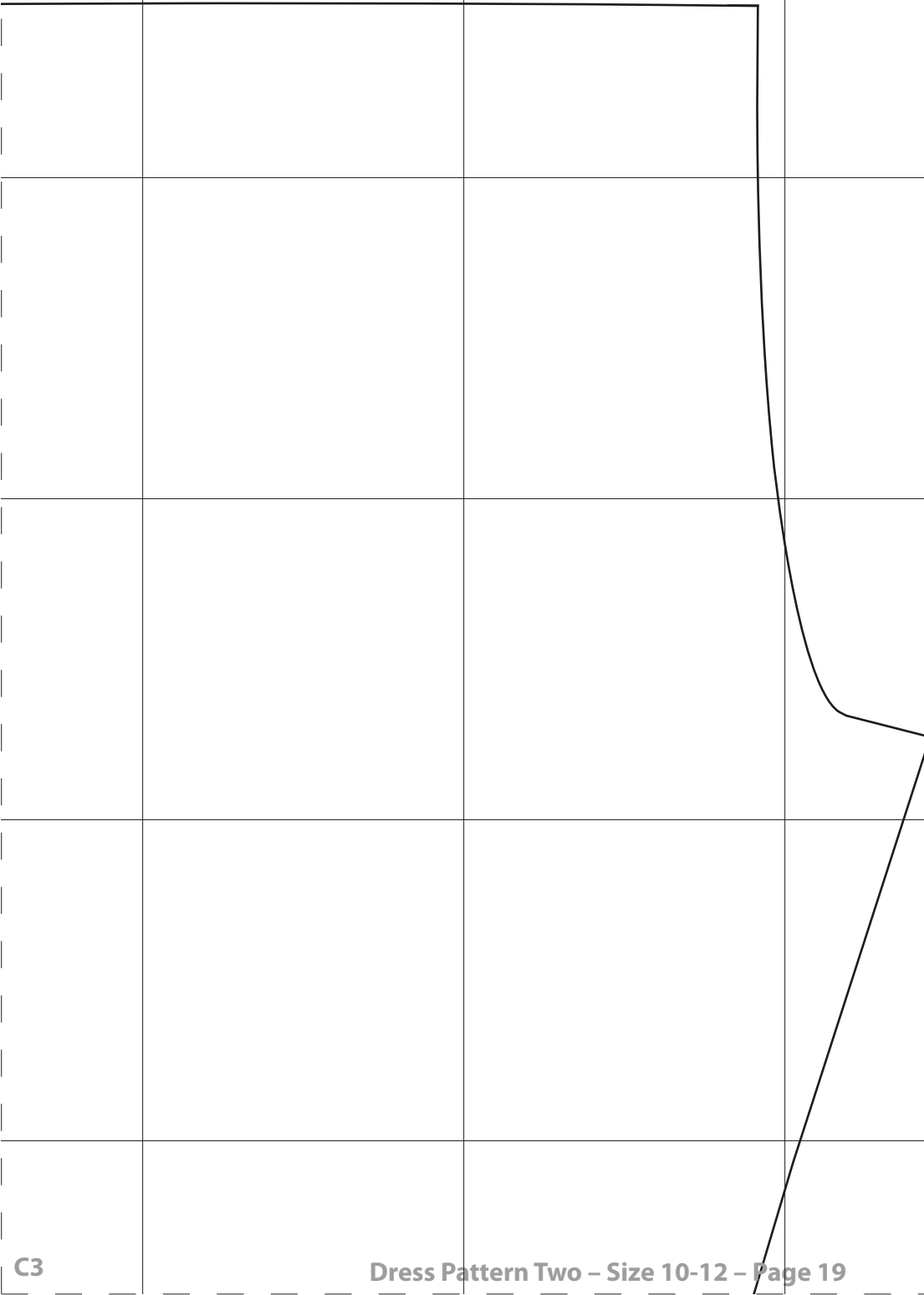

C3

C3

C4

C4

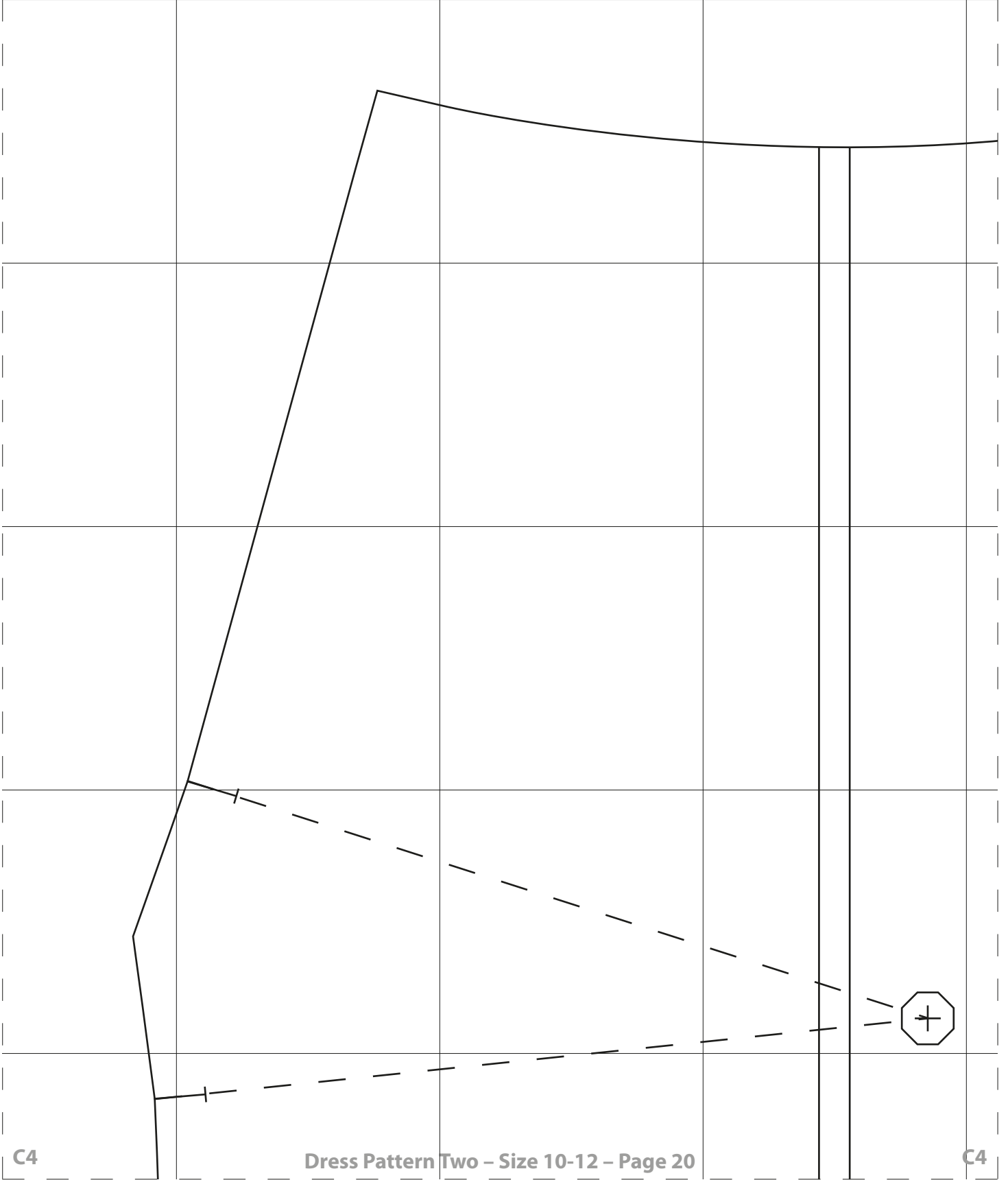

C4

C4

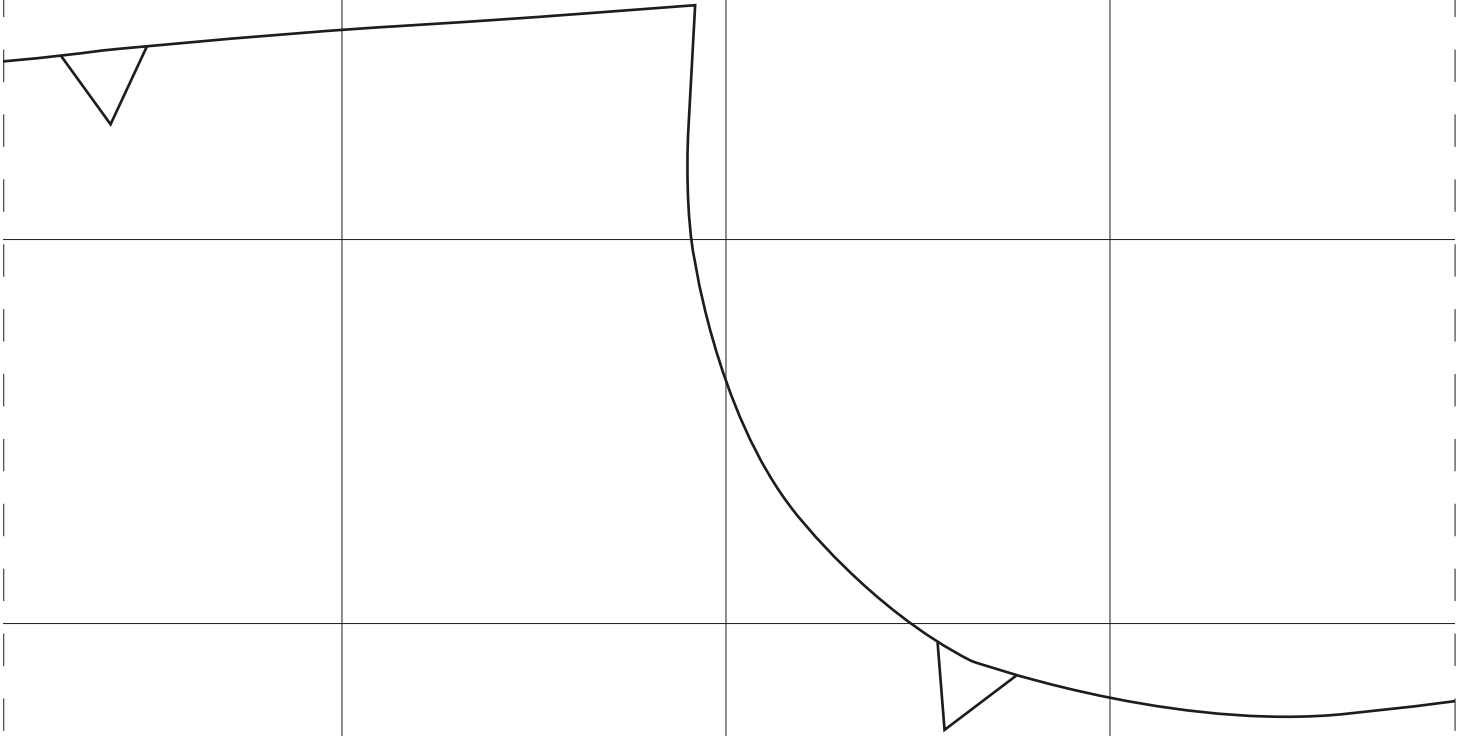

BODICE FRONT
Cut 1 on folded fabric

C6

C6

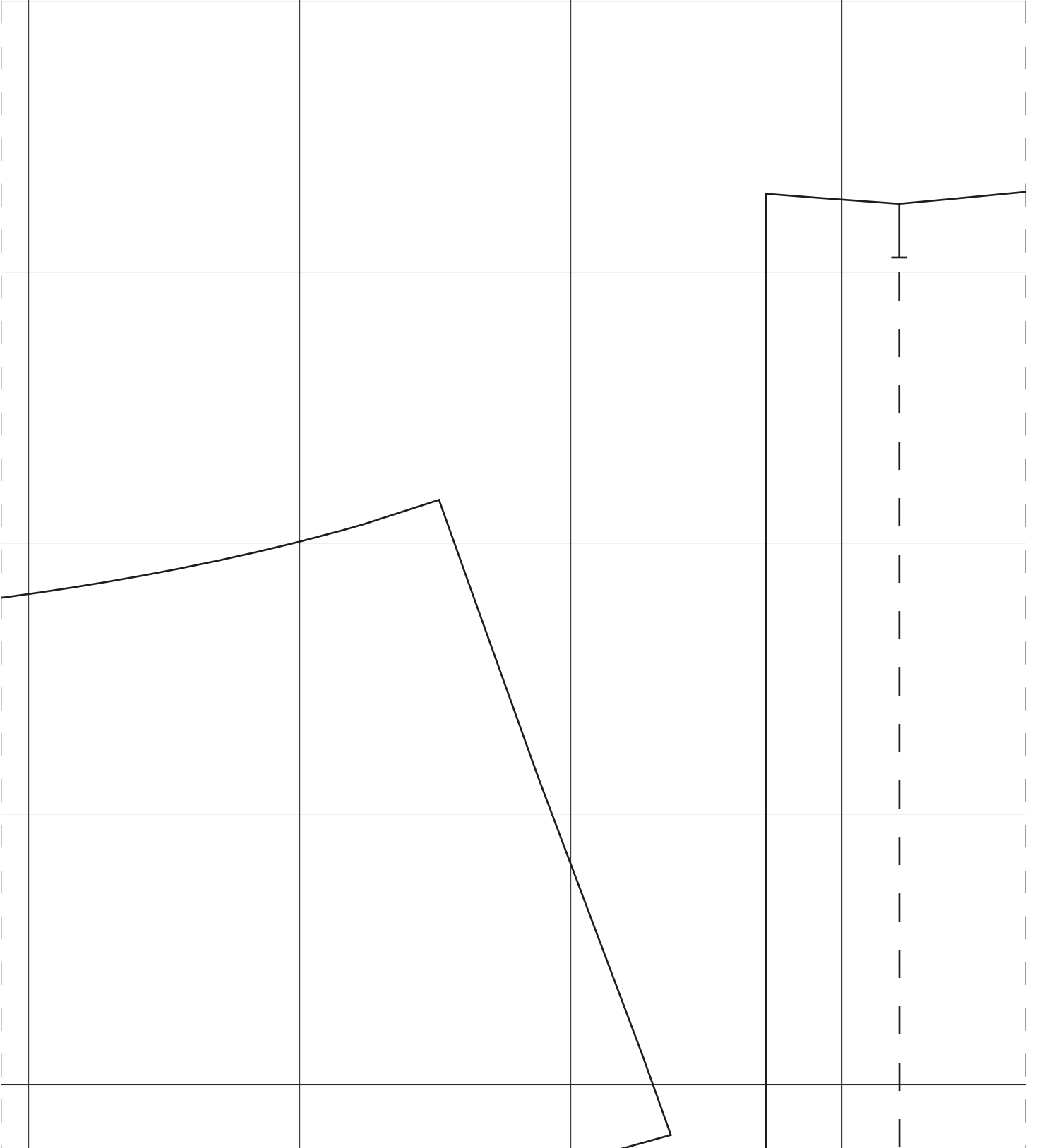

C6

C6

C7

C7

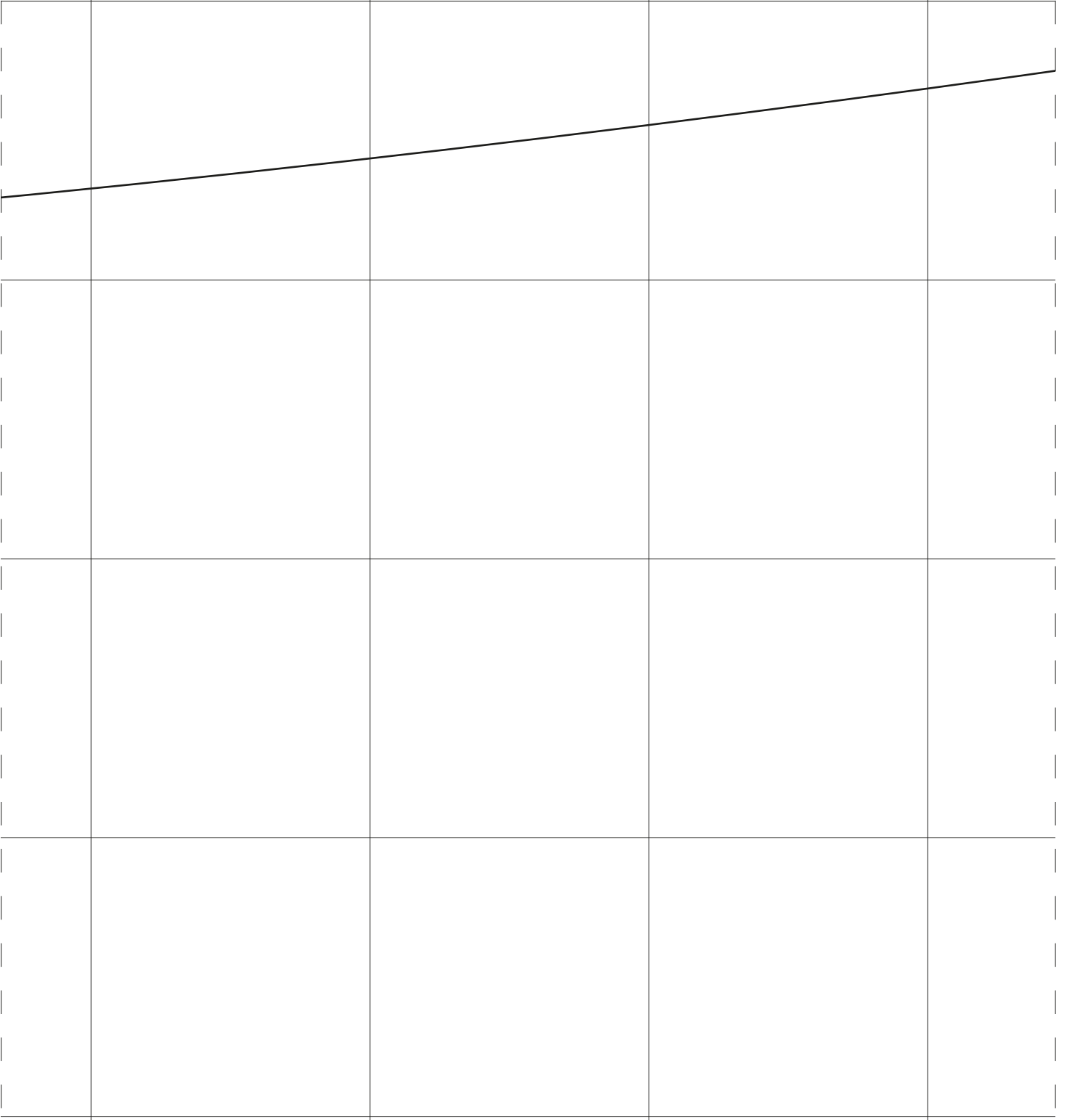

C7

C7

C8

C8

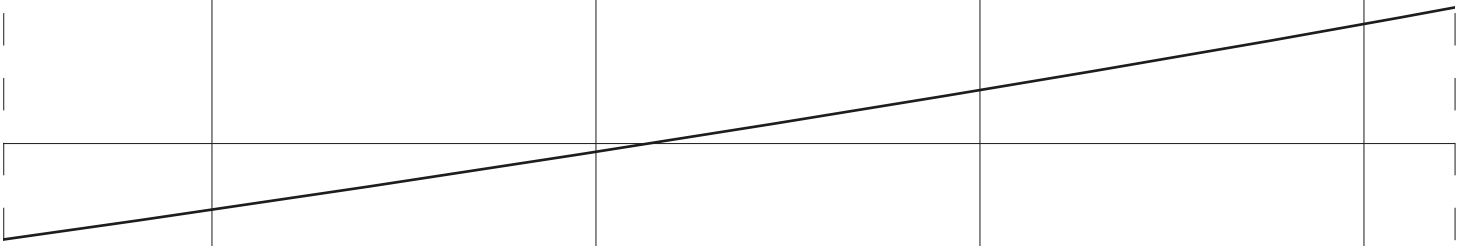

SLEEVE
Cut 2 fabric



C8

C8

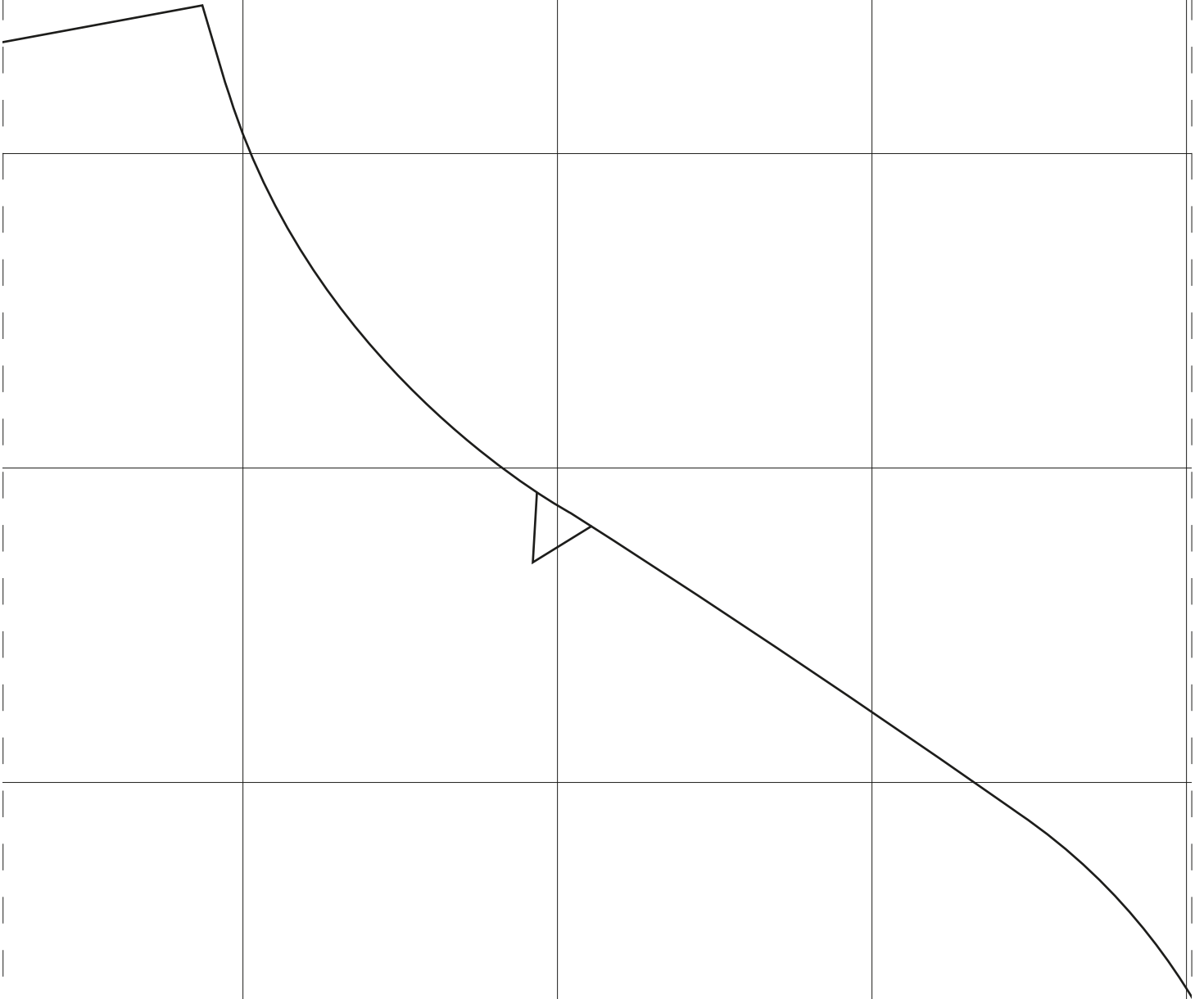

C10



C10

D1

D1

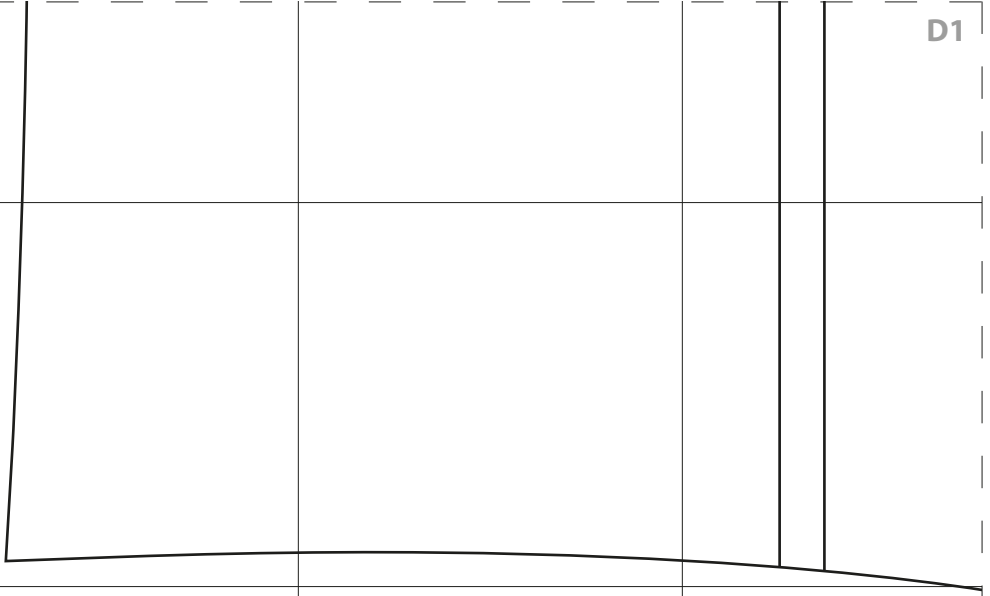

D1

D1

D2

D2

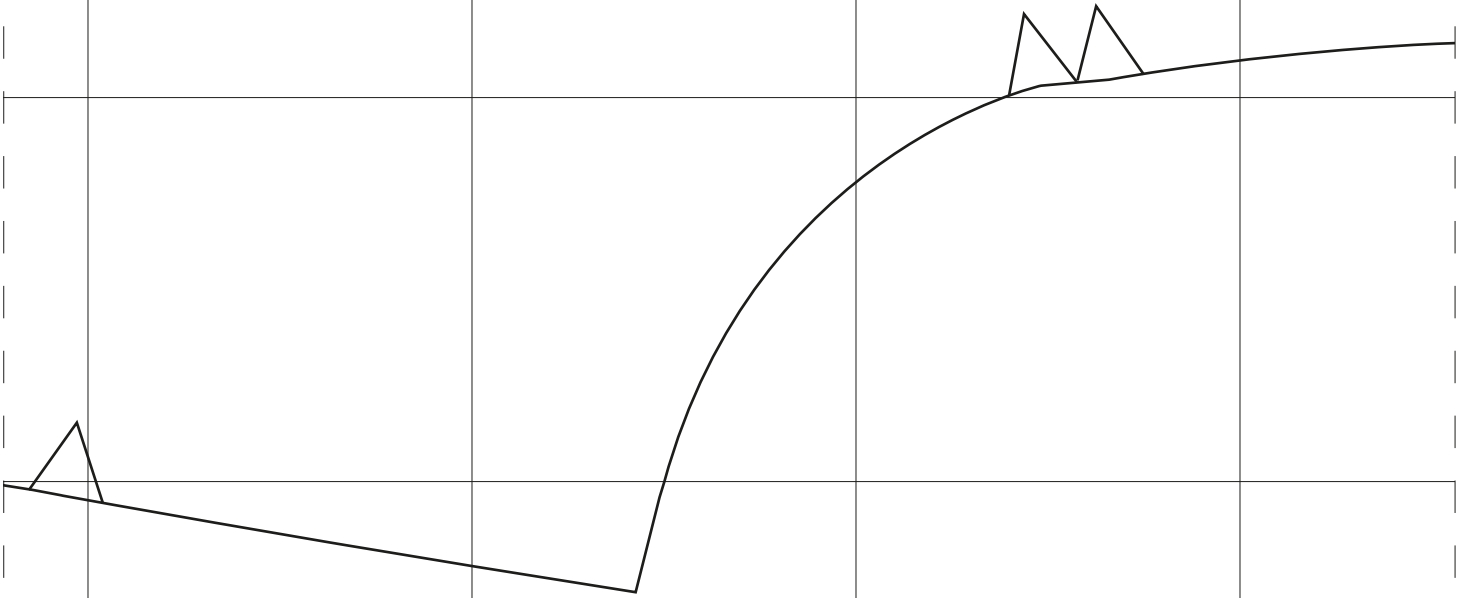

D2

D2

D3

D3

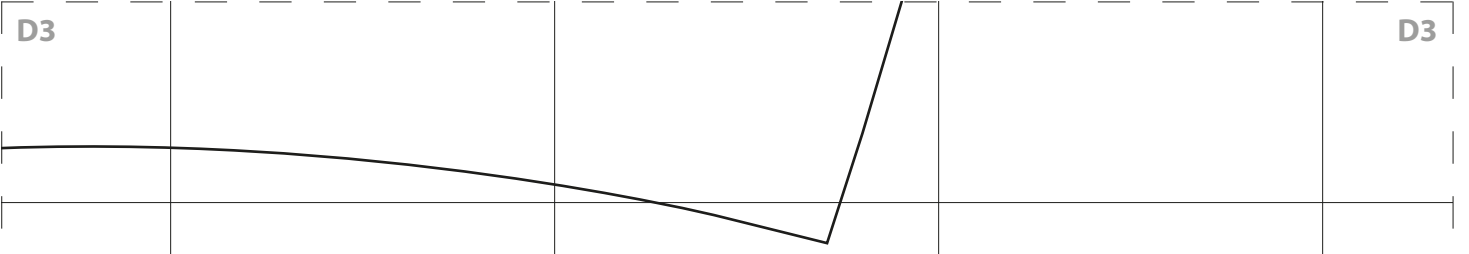

D3

D3

D4

D4

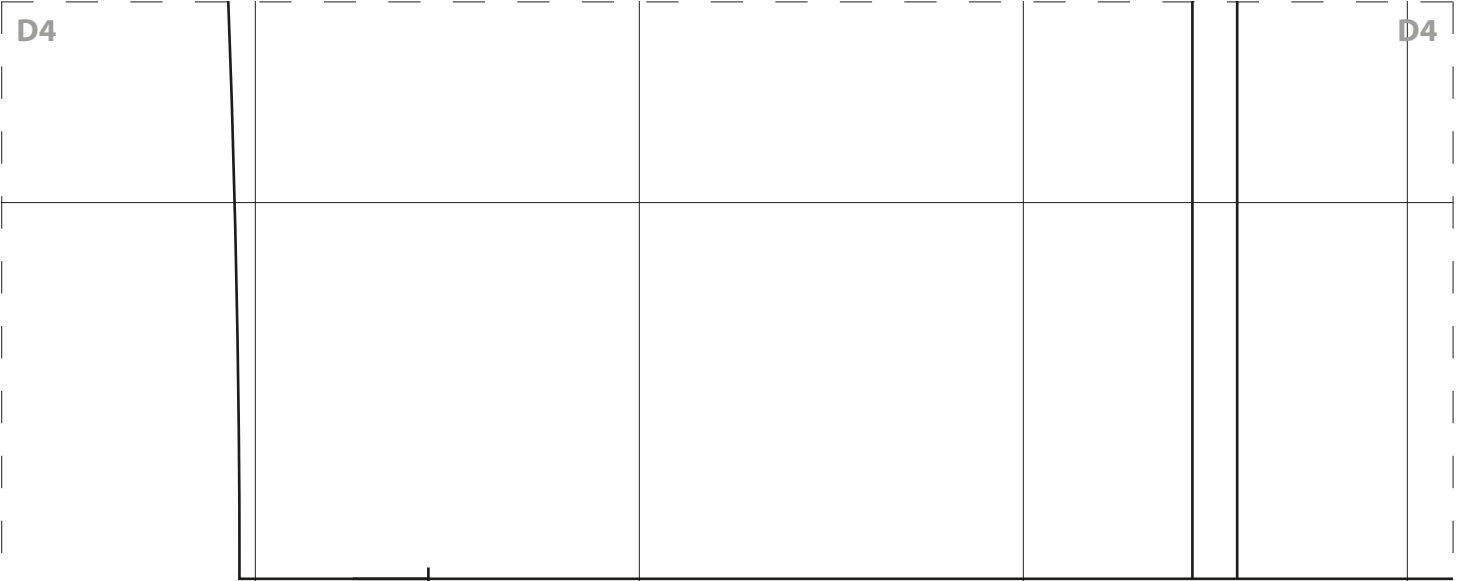

D4

D4

D5

D5



D5

D5

D6

D6

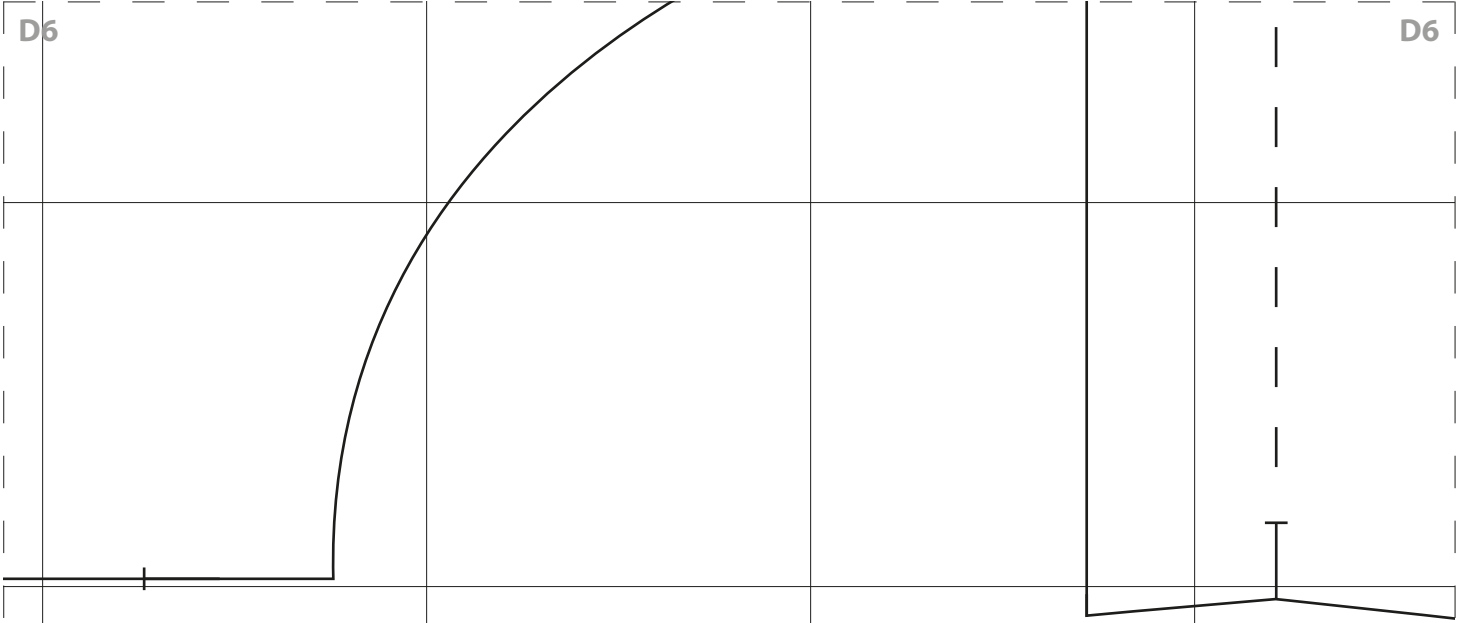

D6

D6

D7

D7

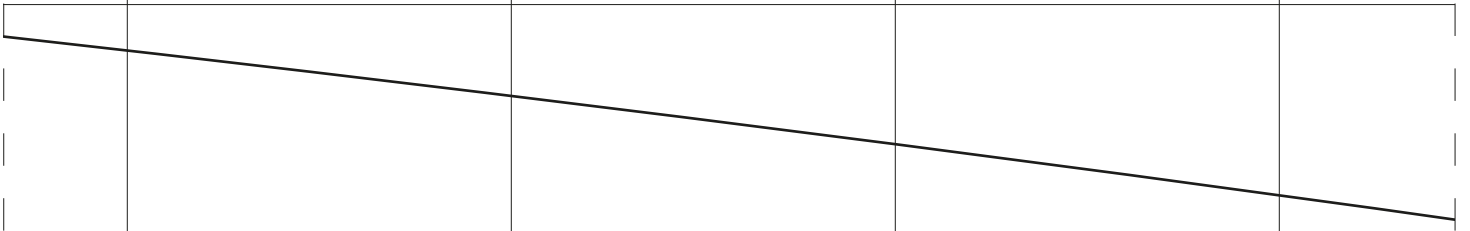

D7

D7

D8

D8

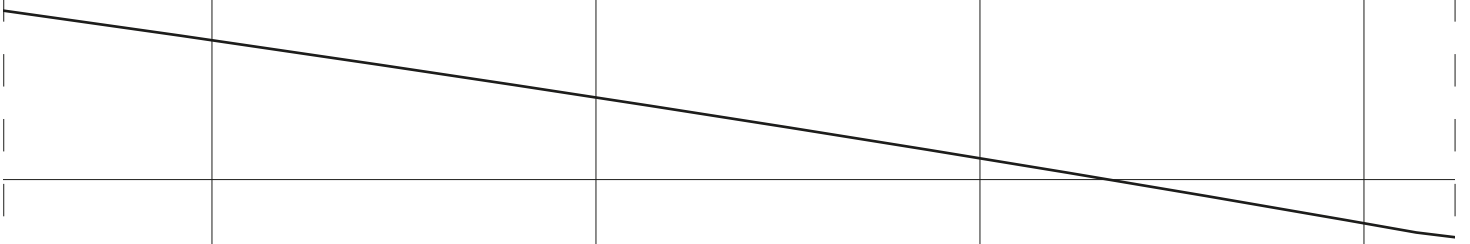

D8

D8

D9

D9

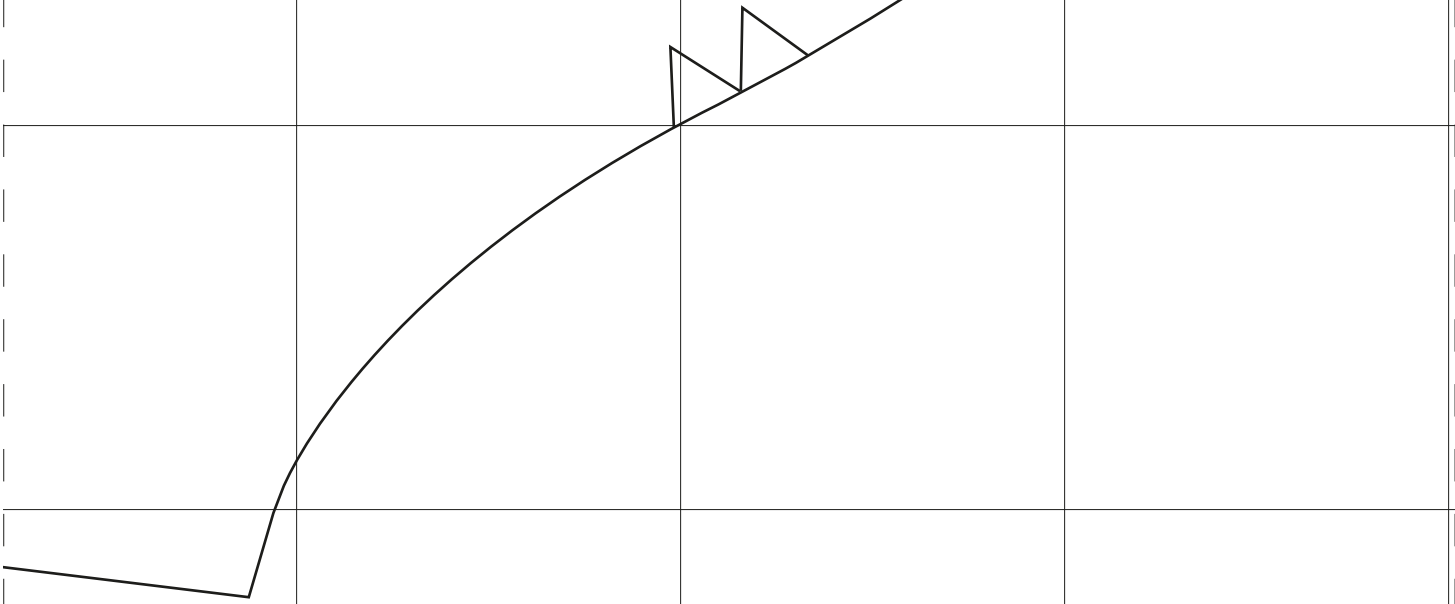

D9

D9

D10

D10

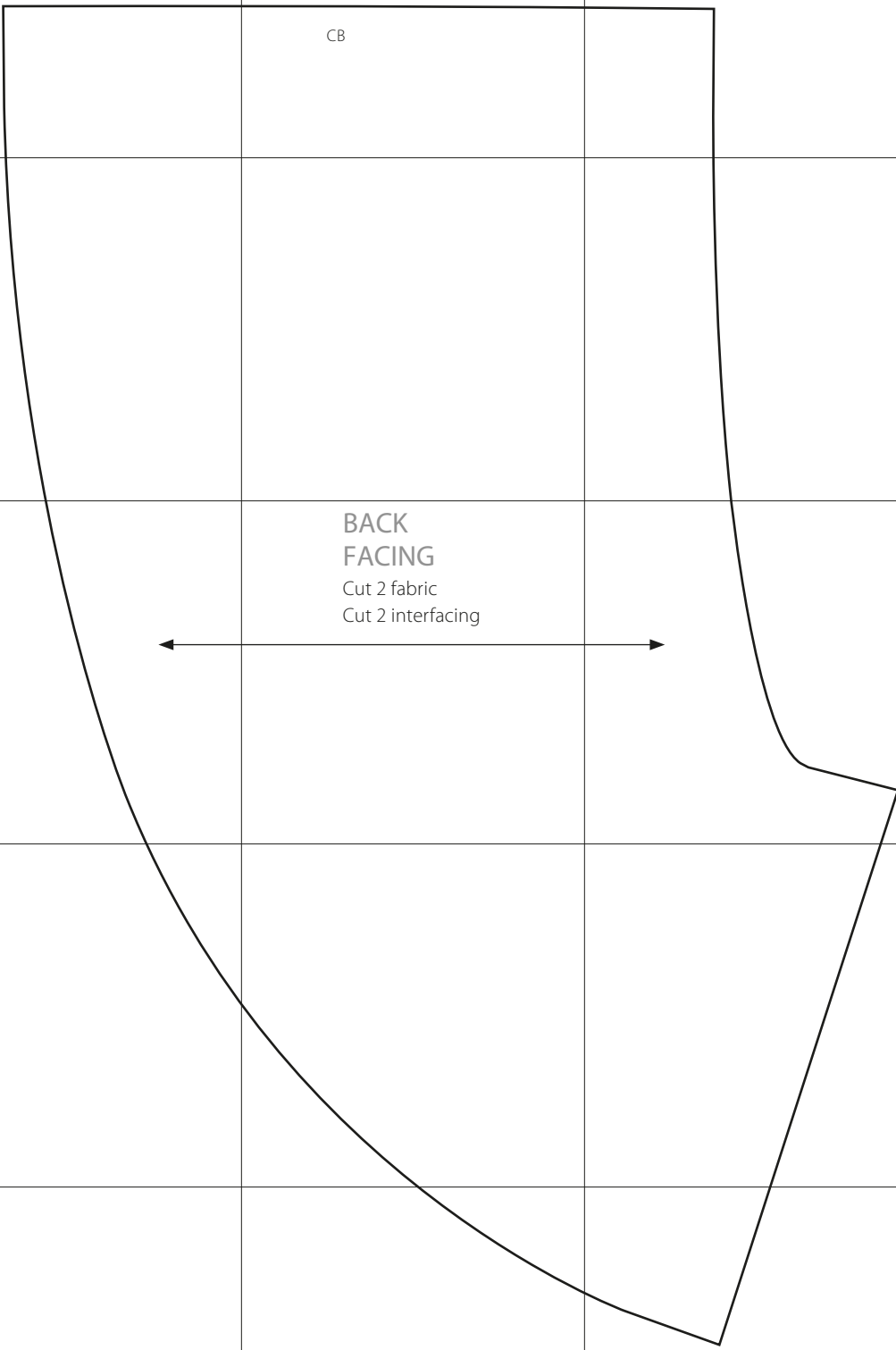

CB

**BACK
FACING**

Cut 2 fabric
Cut 2 interfacing

