

A1

A1

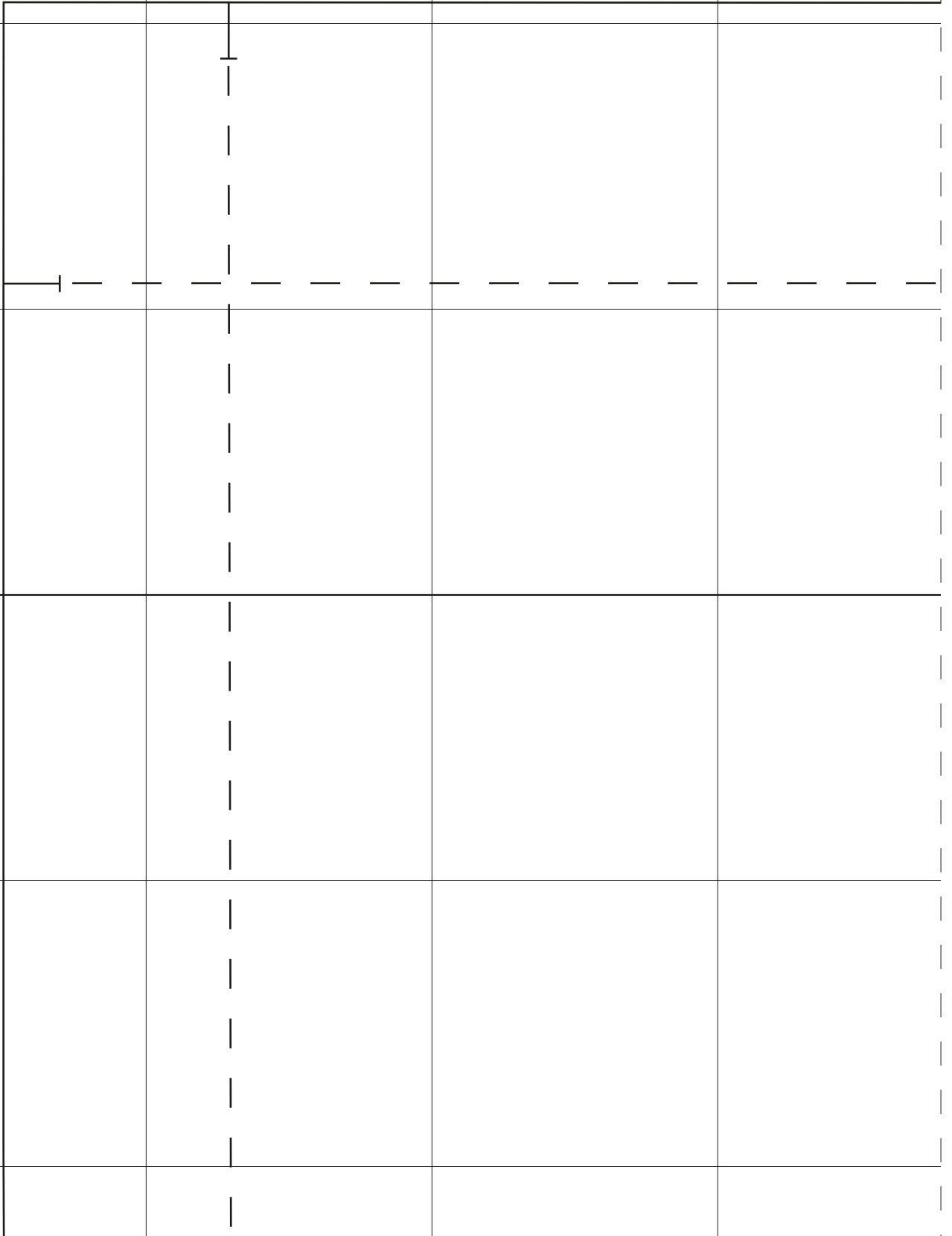

A1

A1

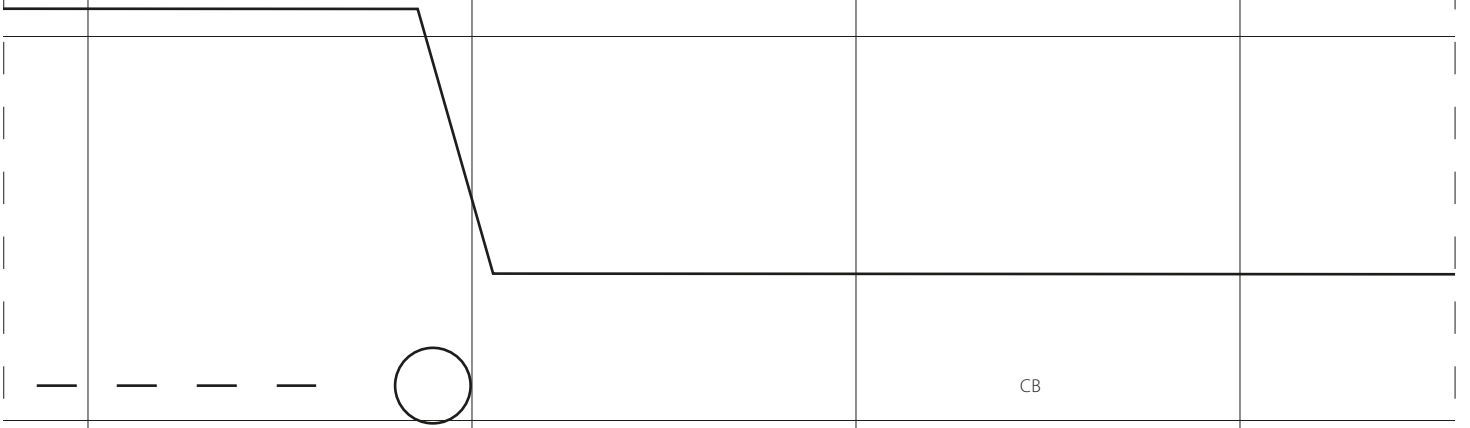

CB

SKIRT BACK
Cut 2 fabric



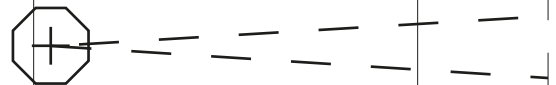

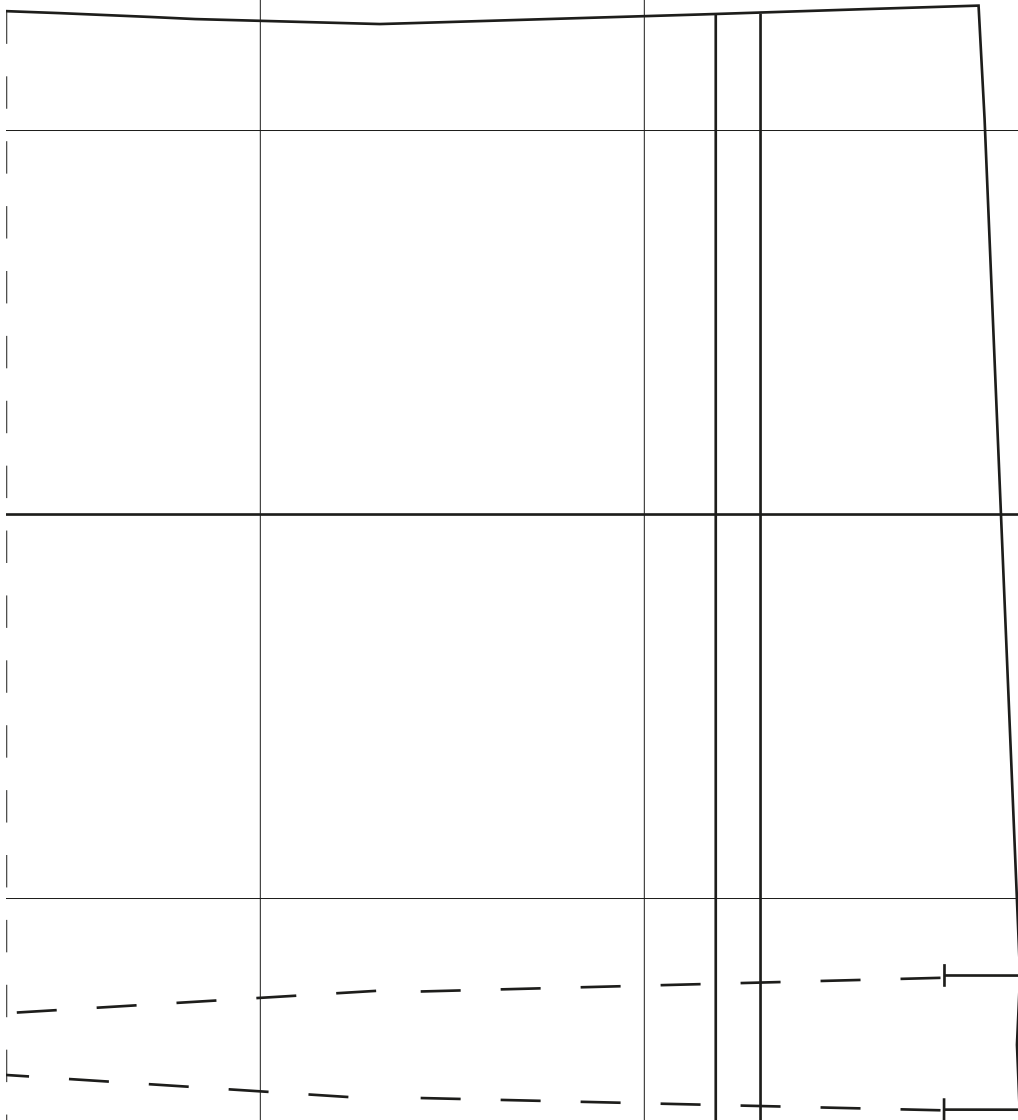

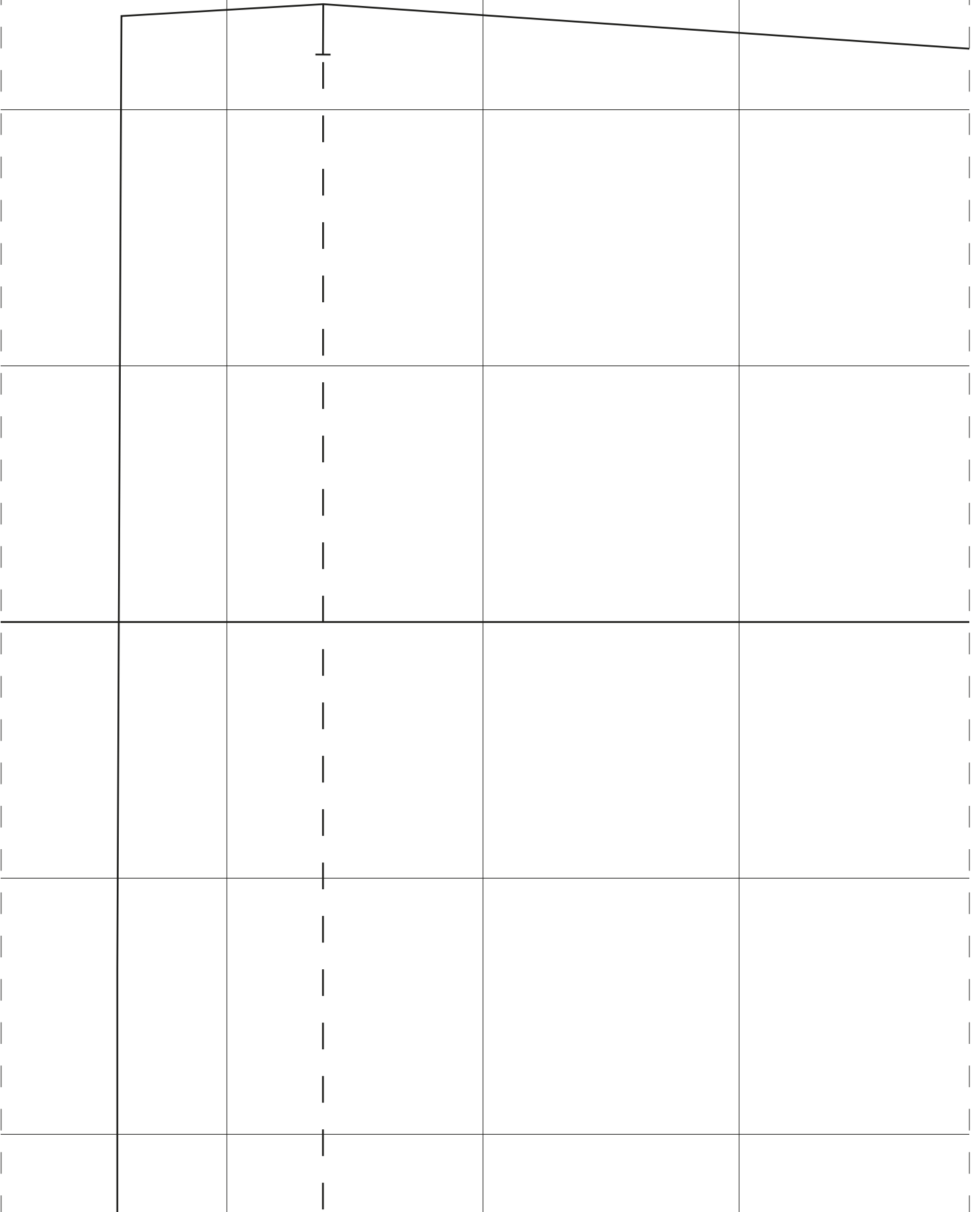

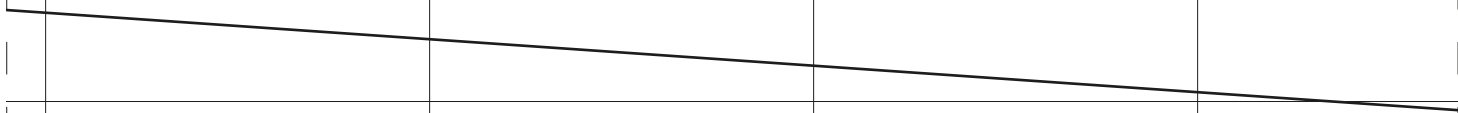

SKIRT FRONT
Cut 1 on folded fabric

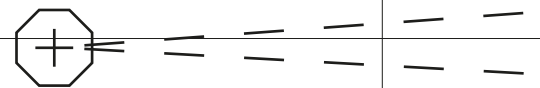
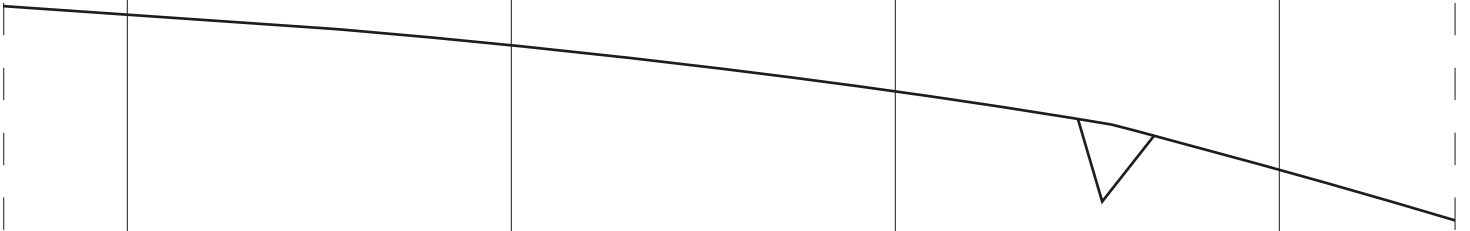

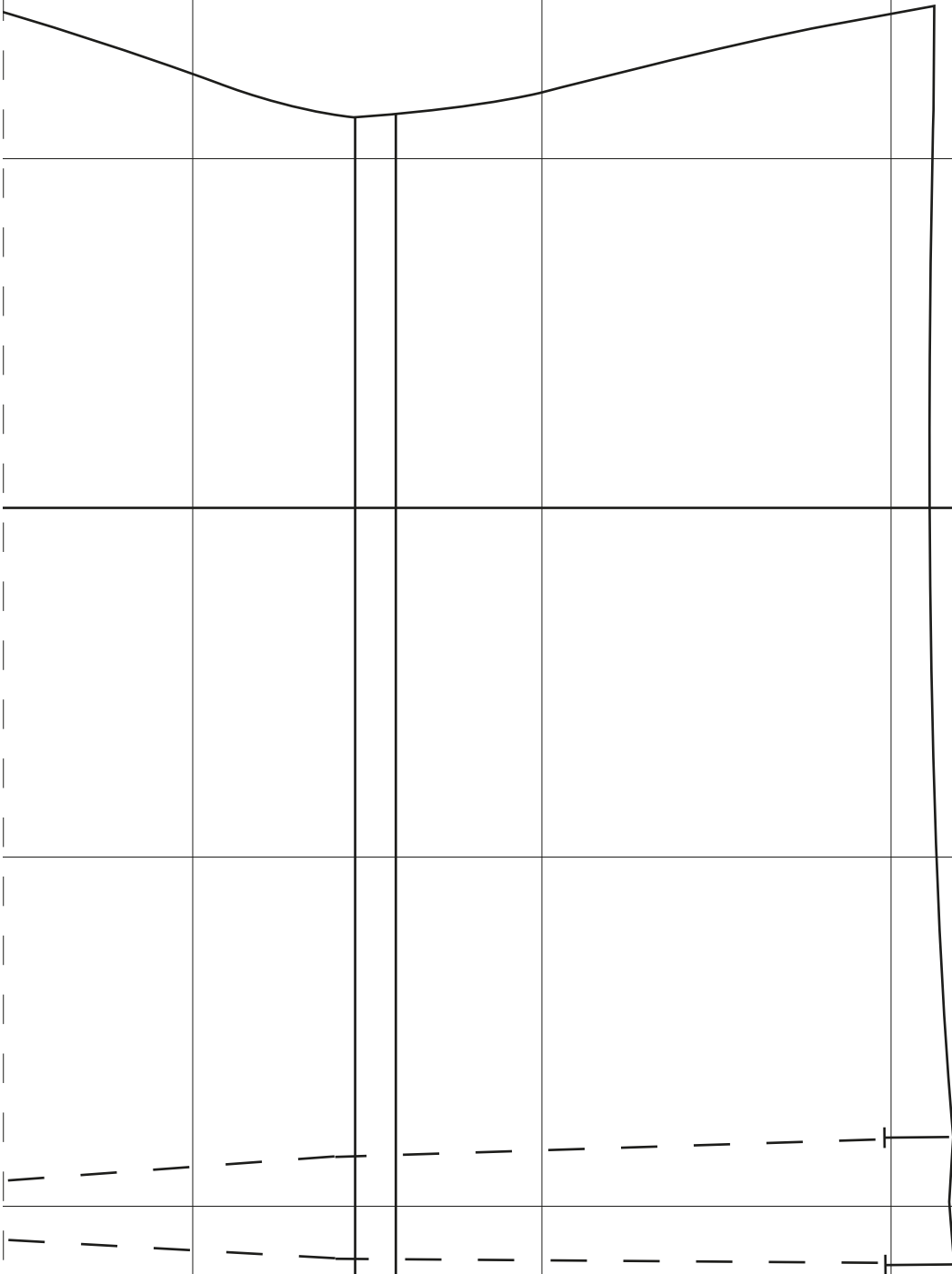

B1

B1

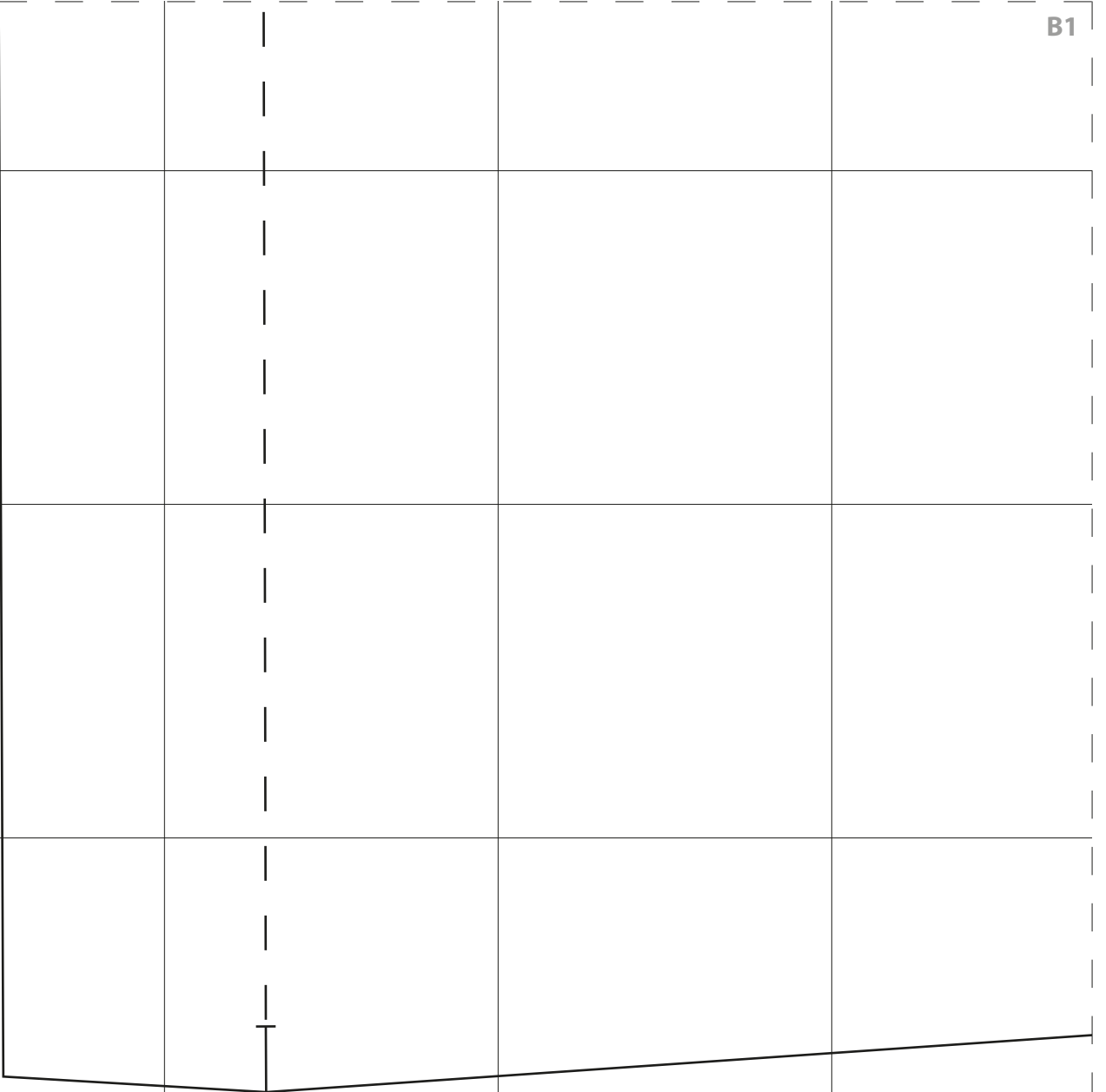

B1

B1

B2

B2



B2

B2

B3

B3

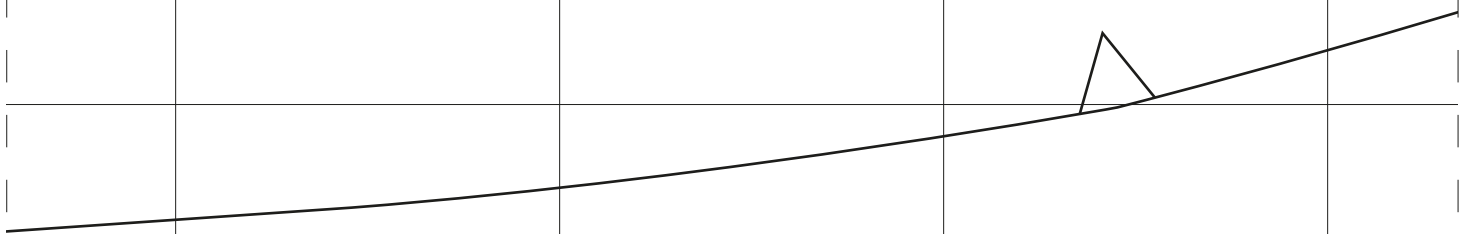

B3

B3

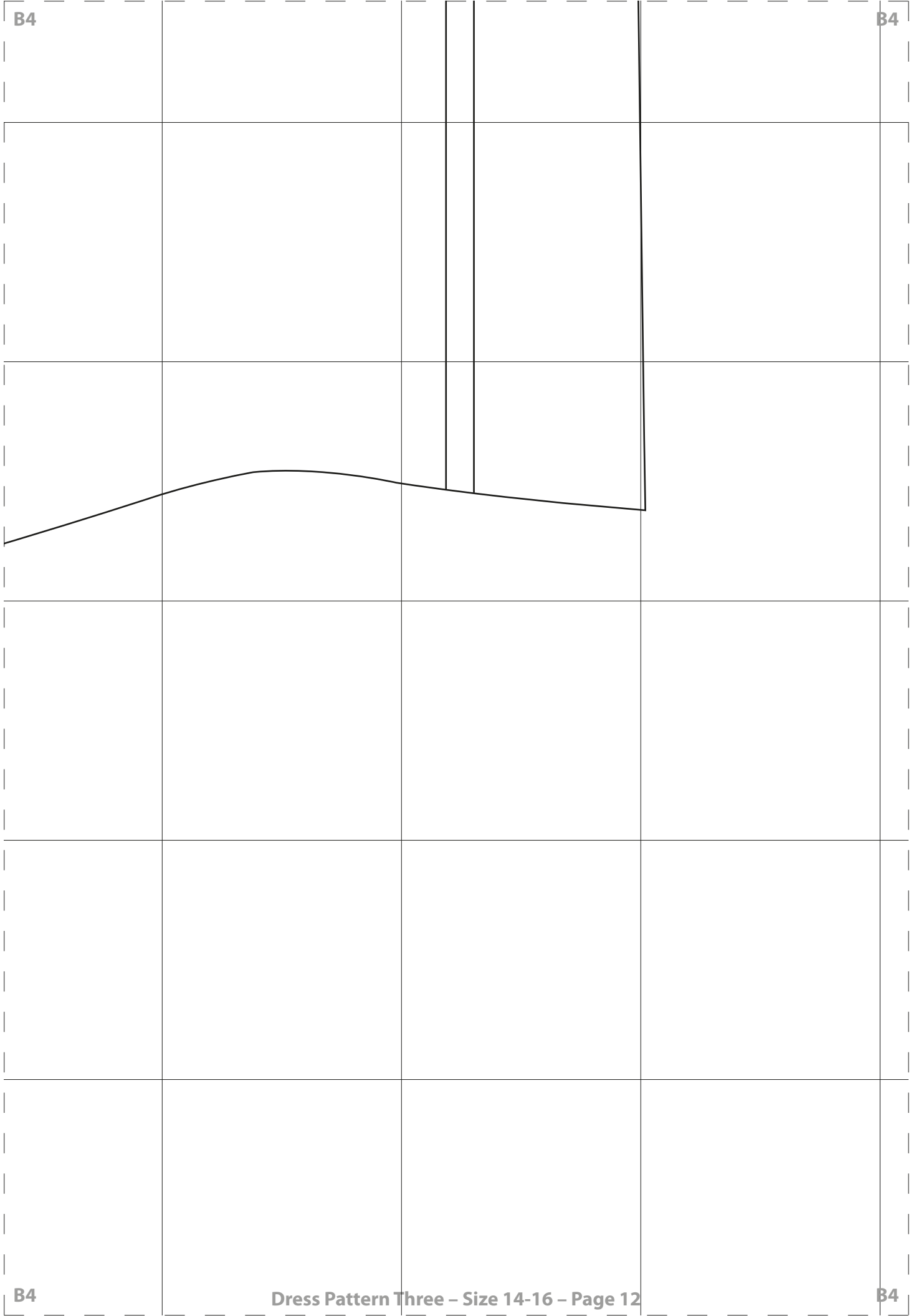

B5

B5

B5

B5

B6

B6



B6

B6

C1

C1

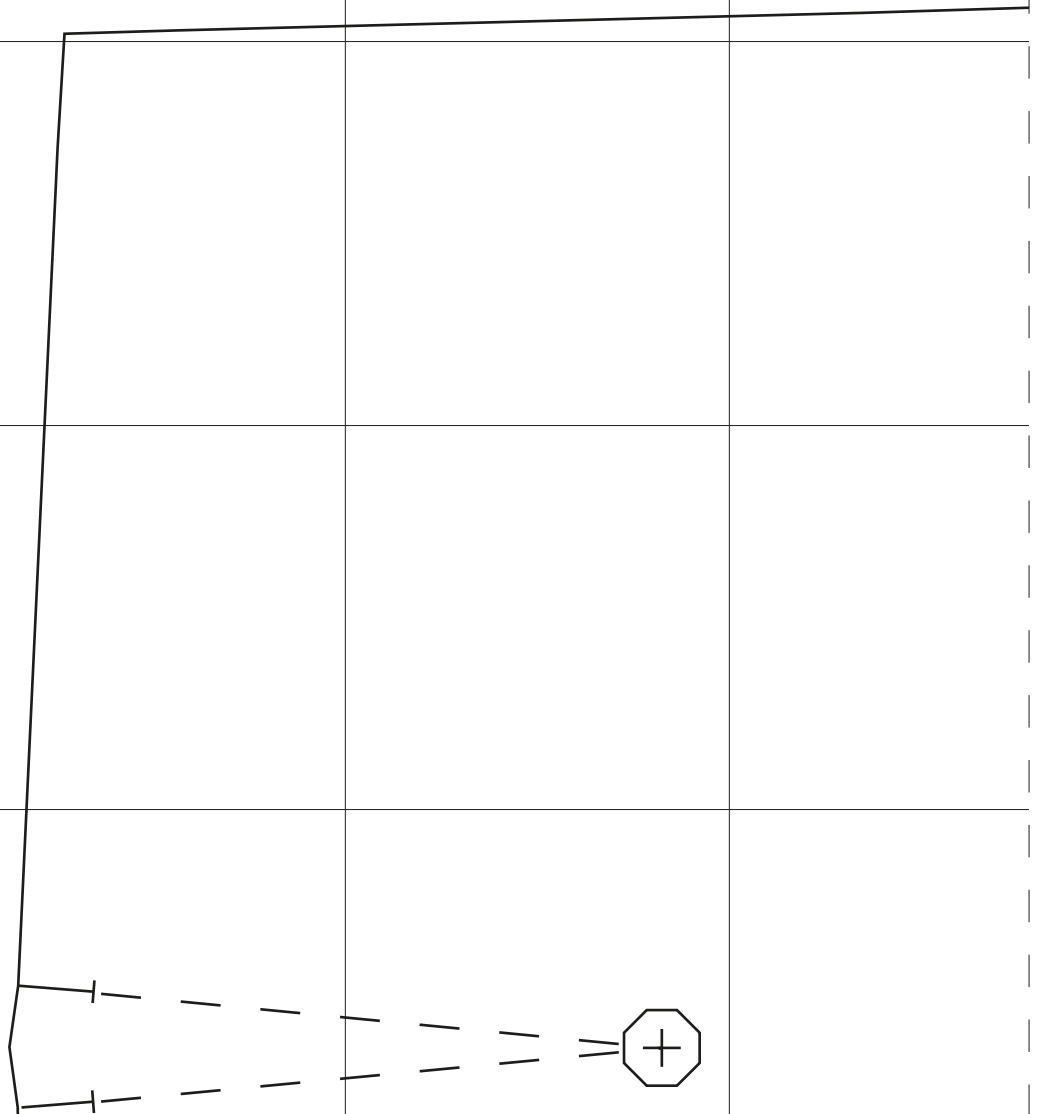

C1

C1

C2

C2

CB

BODICE BACK
Cut 2 fabric



C2

C2

C3

C3

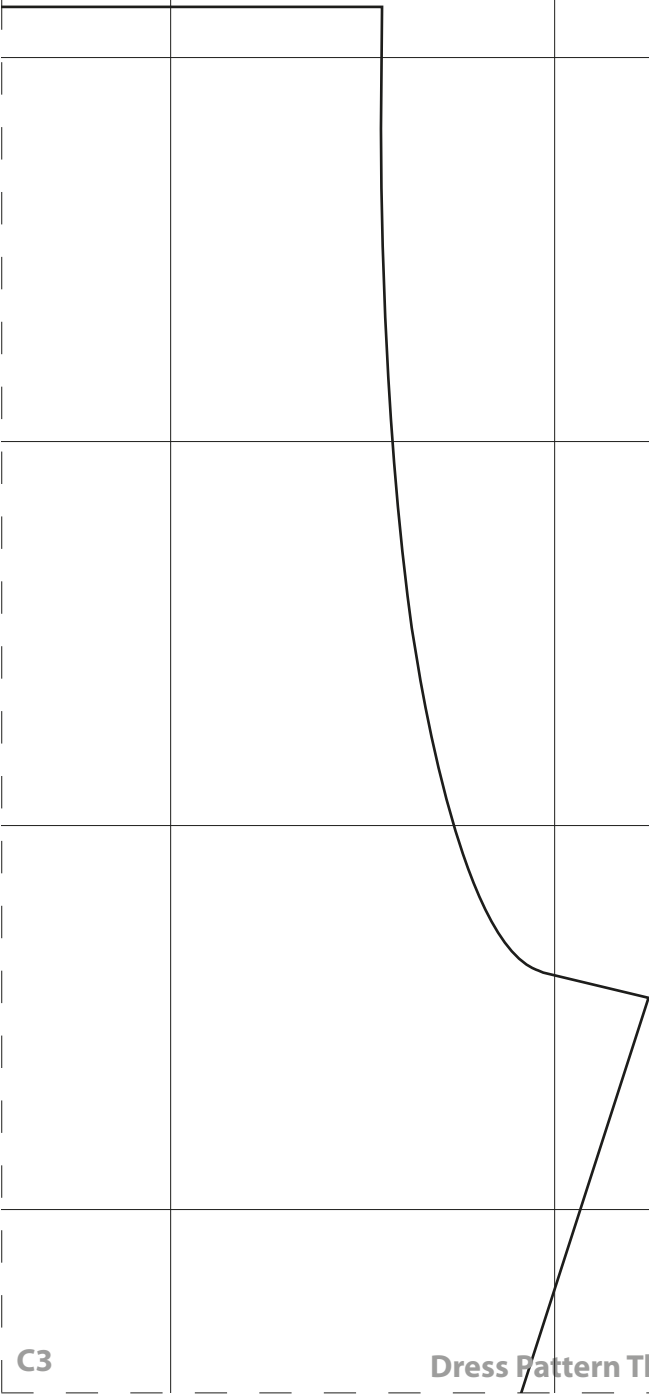

C3

C3

C4

C4

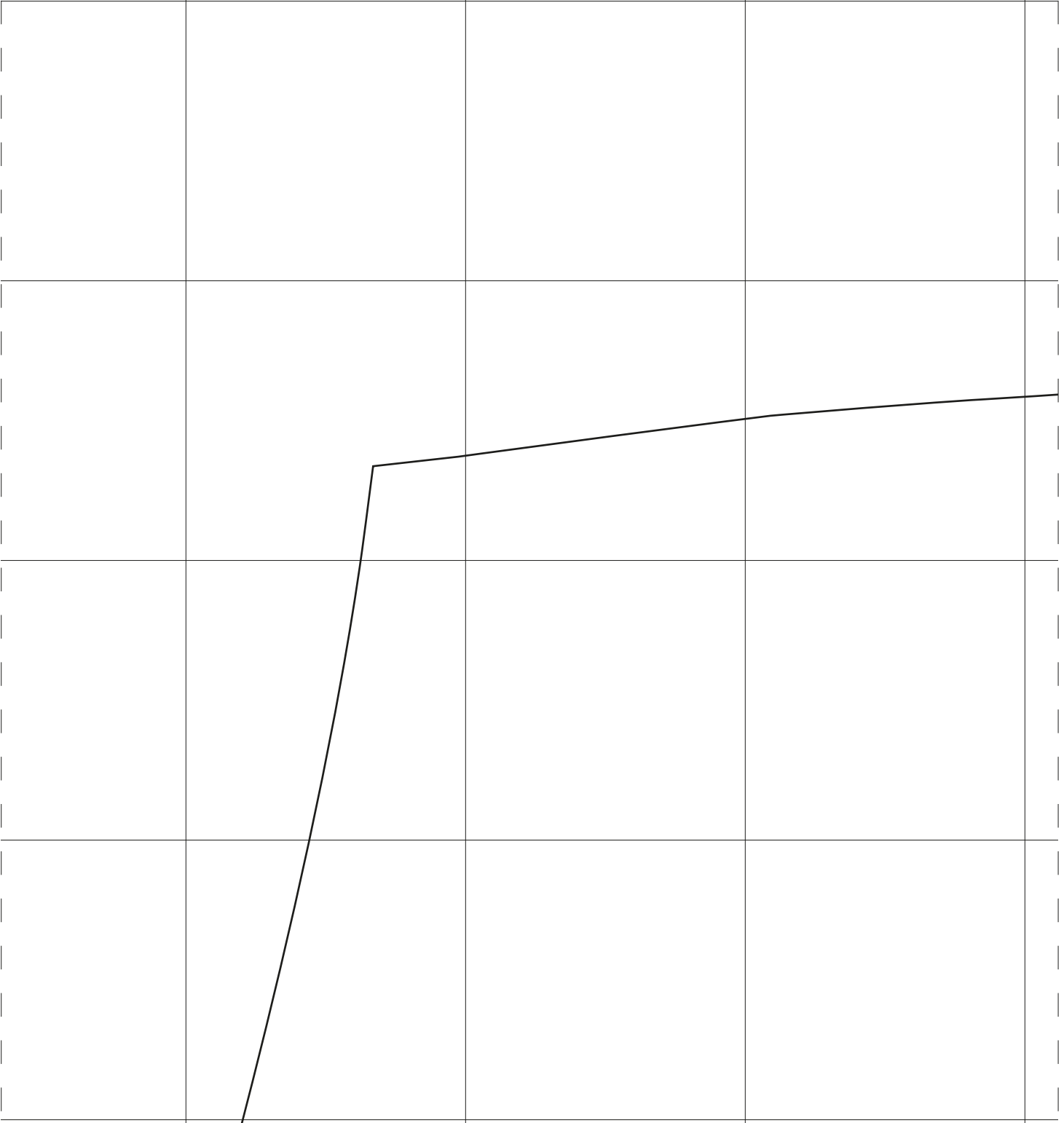

C4

C4

C5

C5

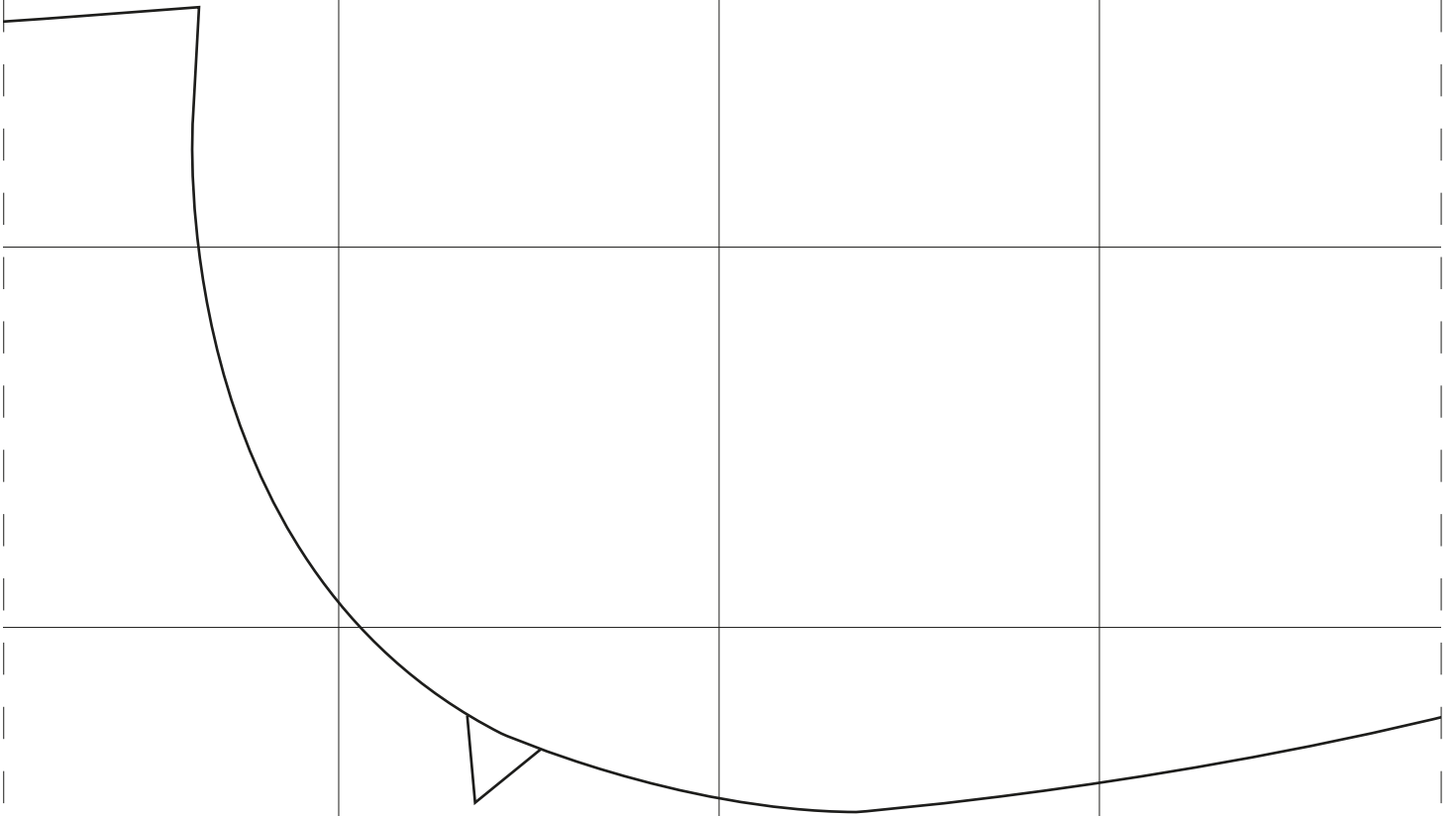

C5

C5

C6

C6

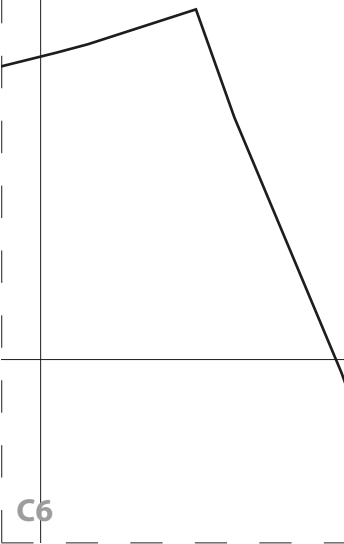

C6

C6

D1

D1

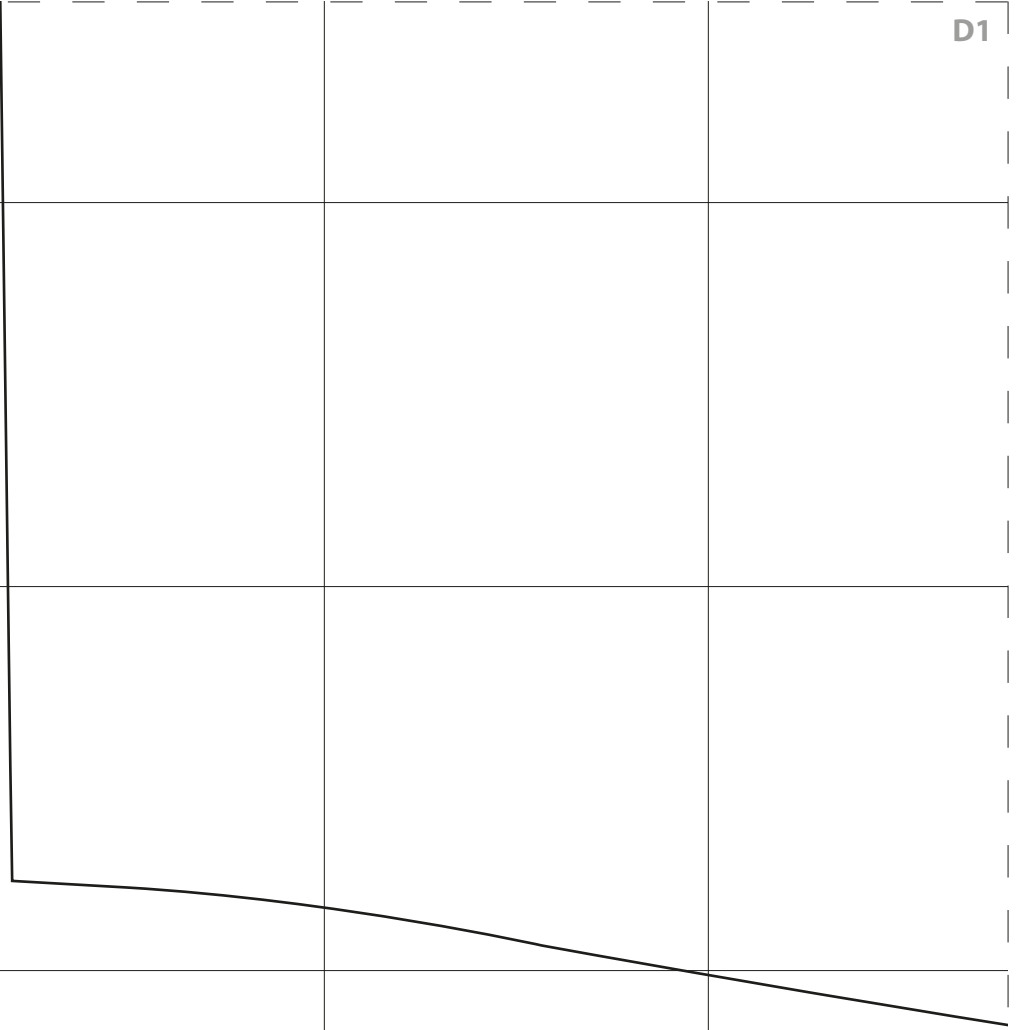

D1

D1

D2

D2

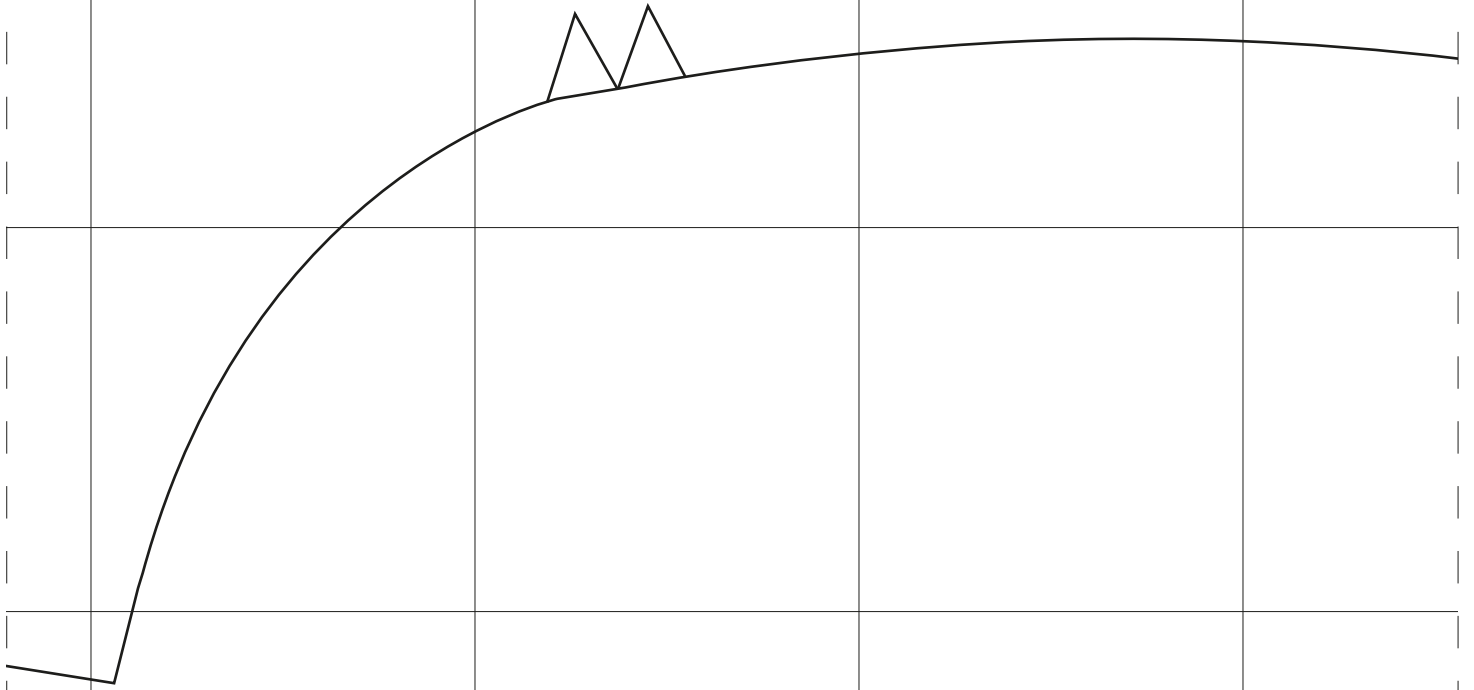

D2

D2

D3

D3

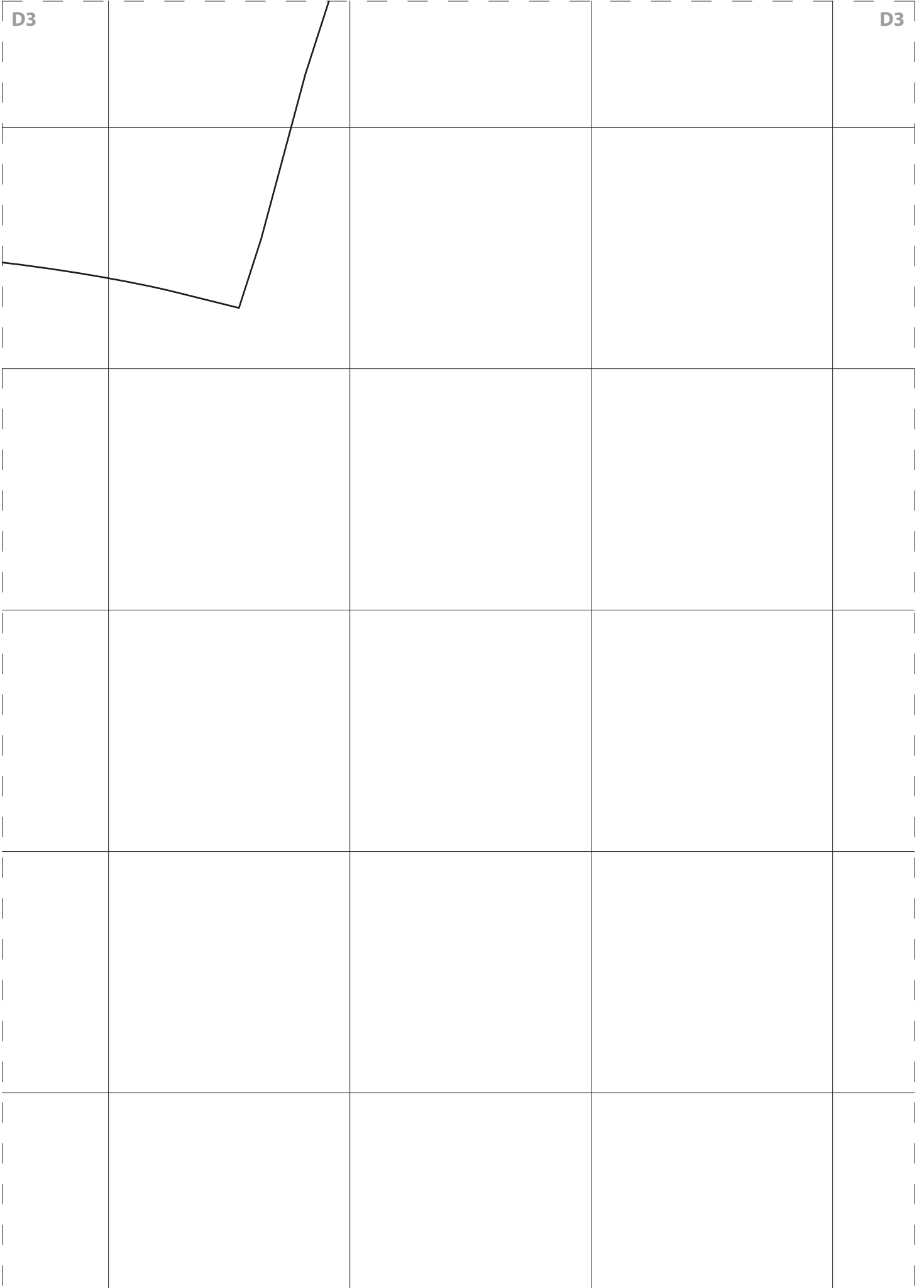

D3

D3

D4

D4

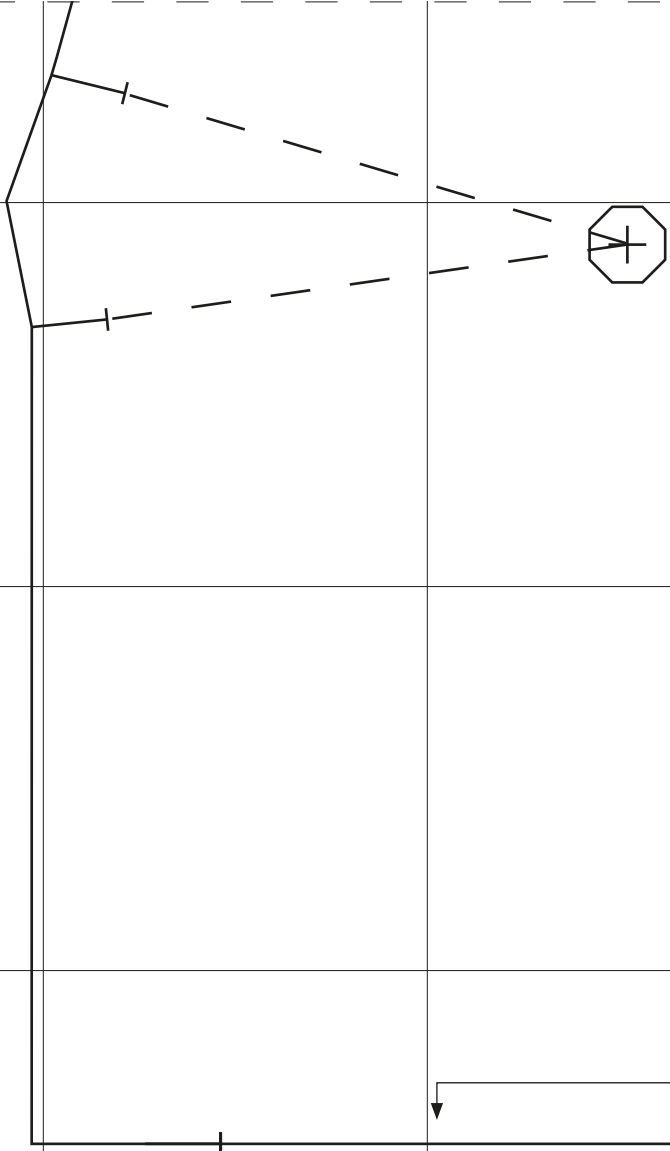

D4

D4

D5

D5

BODICE FRONT
Cut 1 on folded fabric

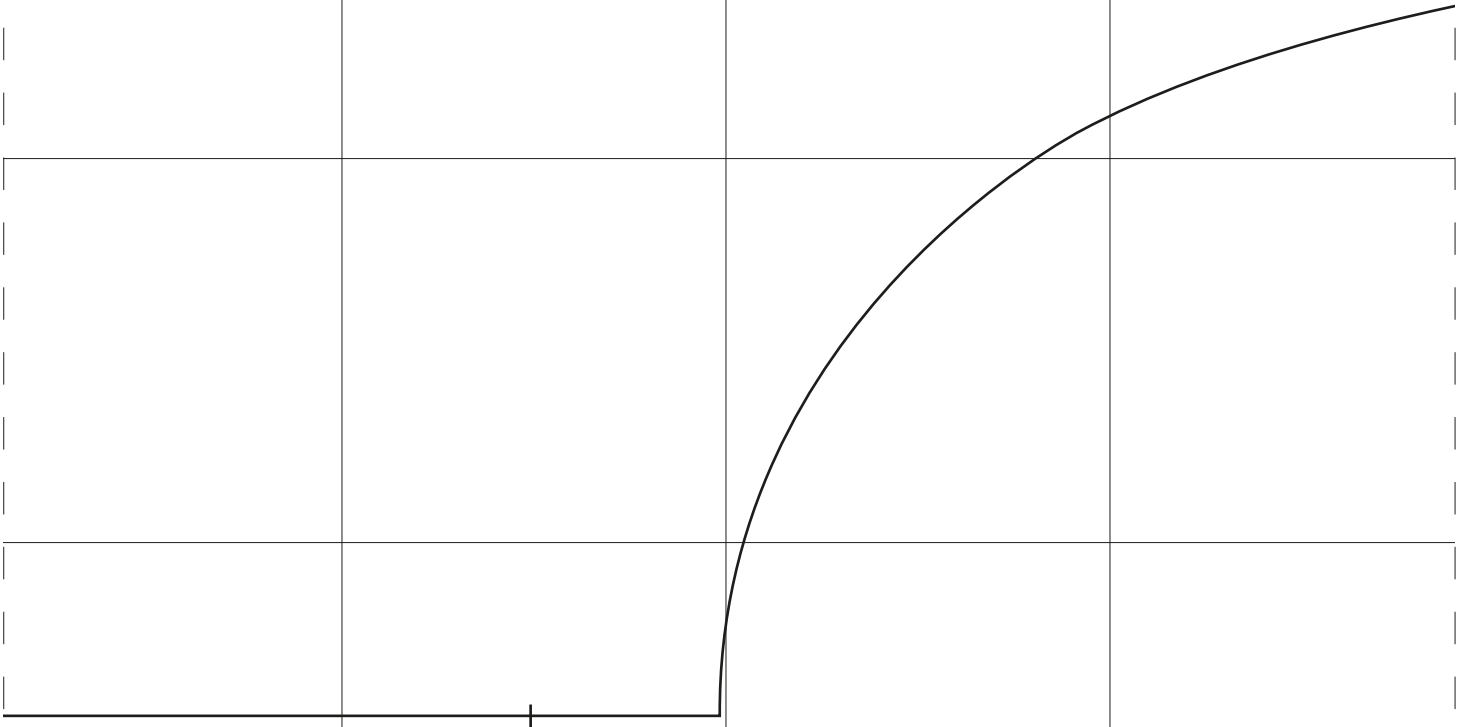

D5

D5

D6

D6

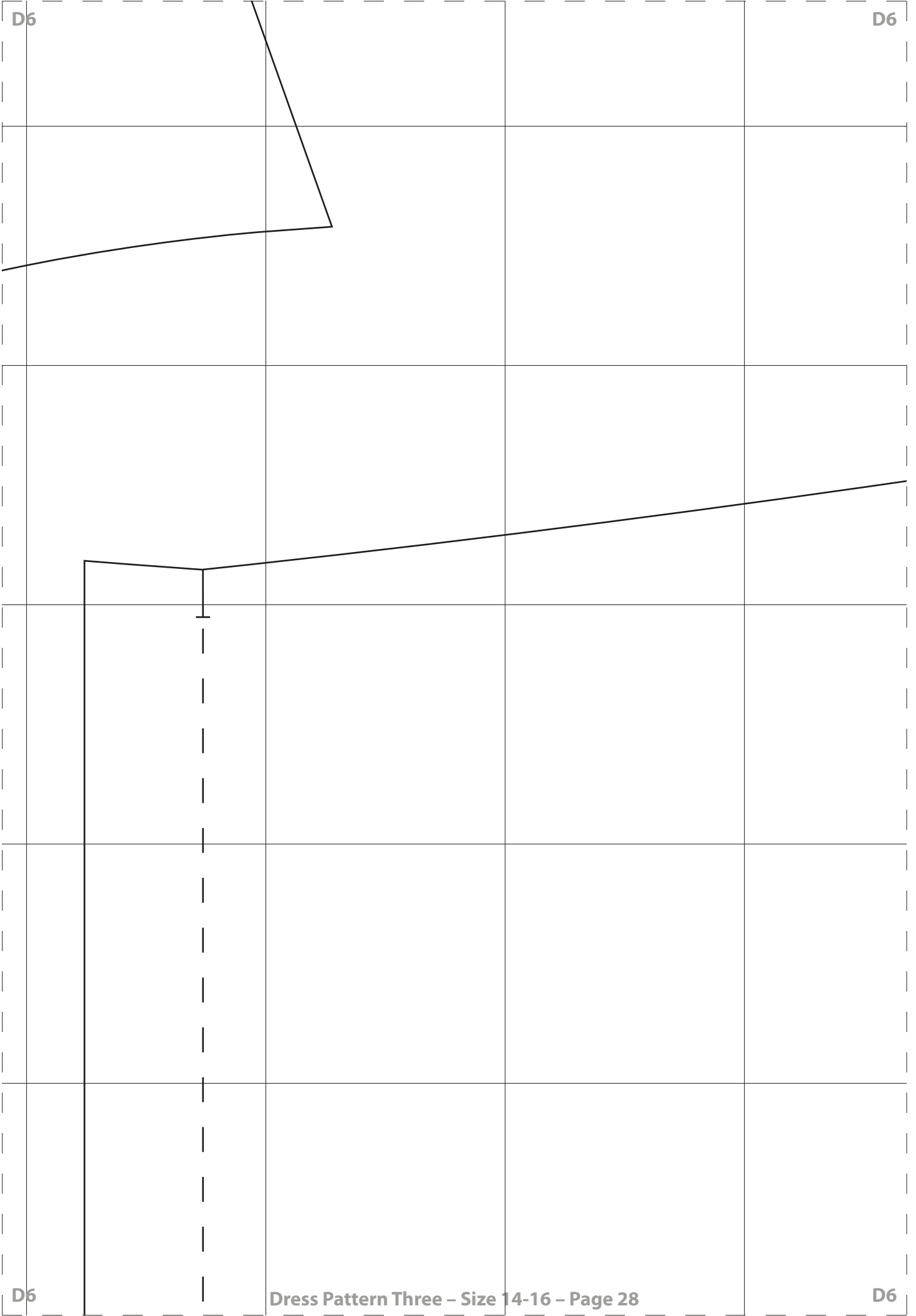

D6

D6

D7

D7

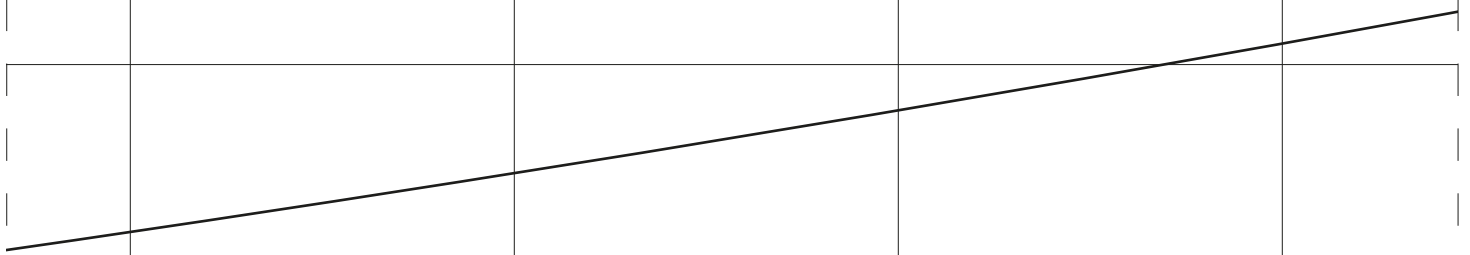

SLEEVE
Cut 2 fabric

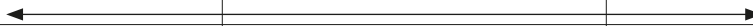

D7

D7

D8

D8

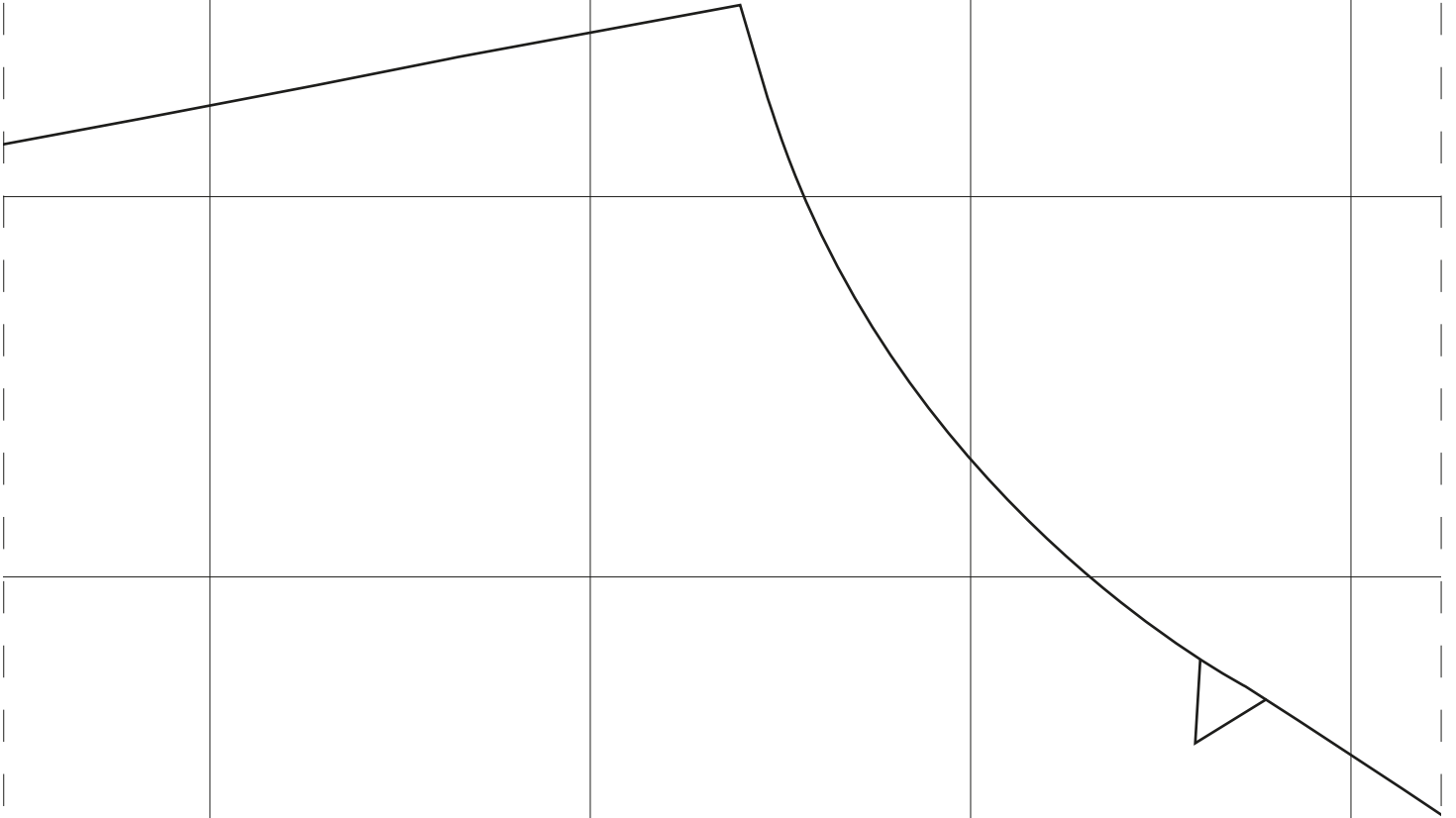

D8

D8

D9

D9

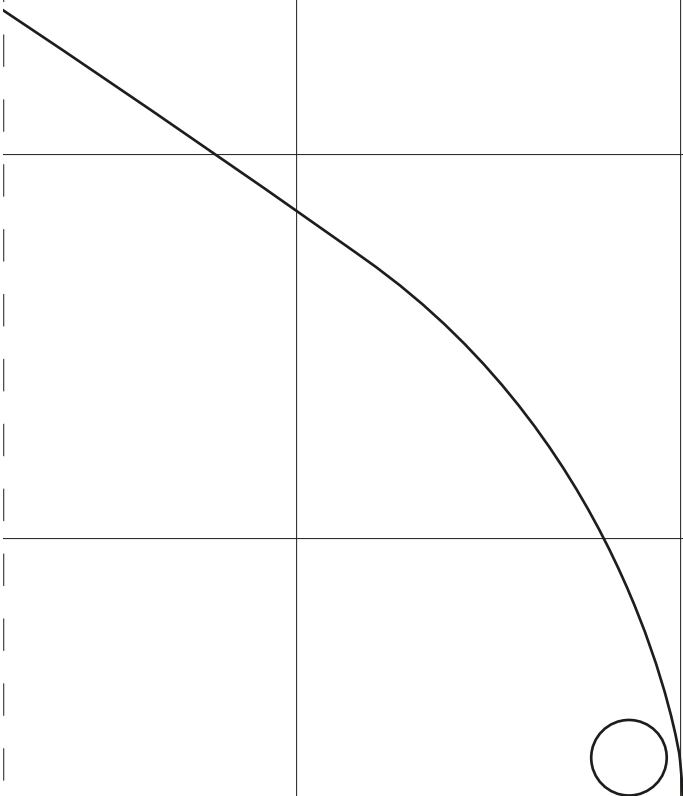

D9

D9

E1

E1

CB

BACK FACING
Cut 2 fabric
Cut 2 interfacing



E1

E1

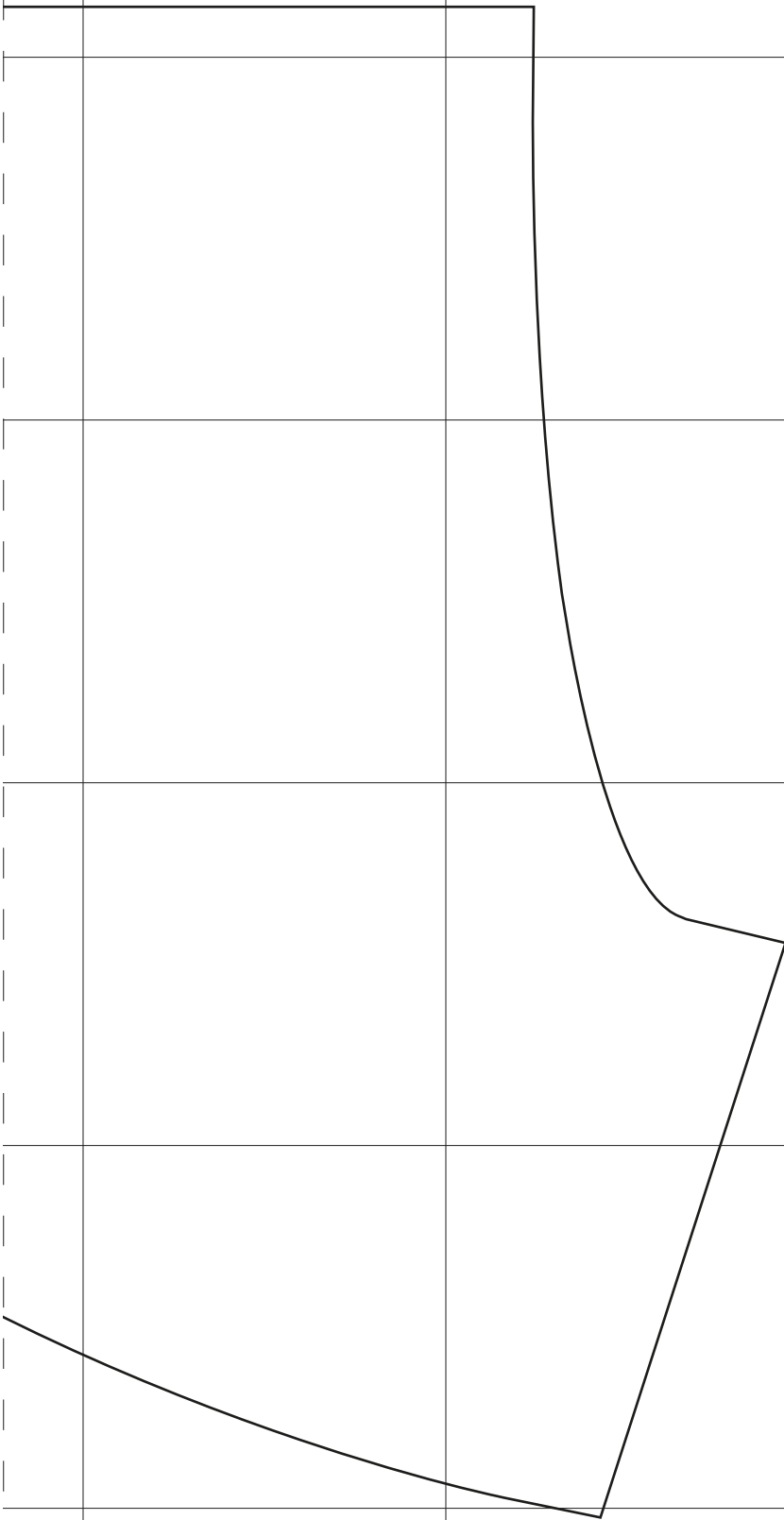

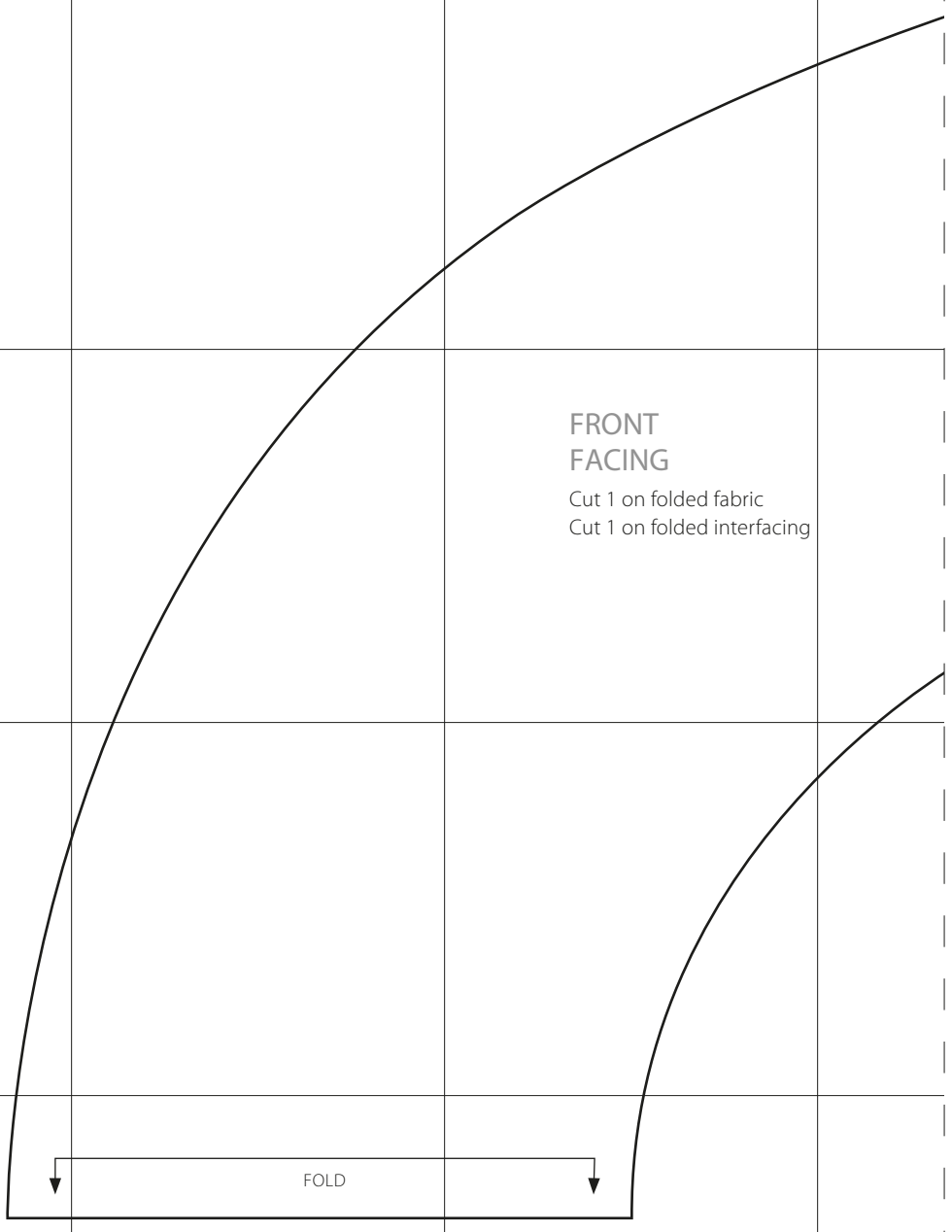

FRONT
FACING

Cut 1 on folded fabric
Cut 1 on folded interfacing

E4

E4

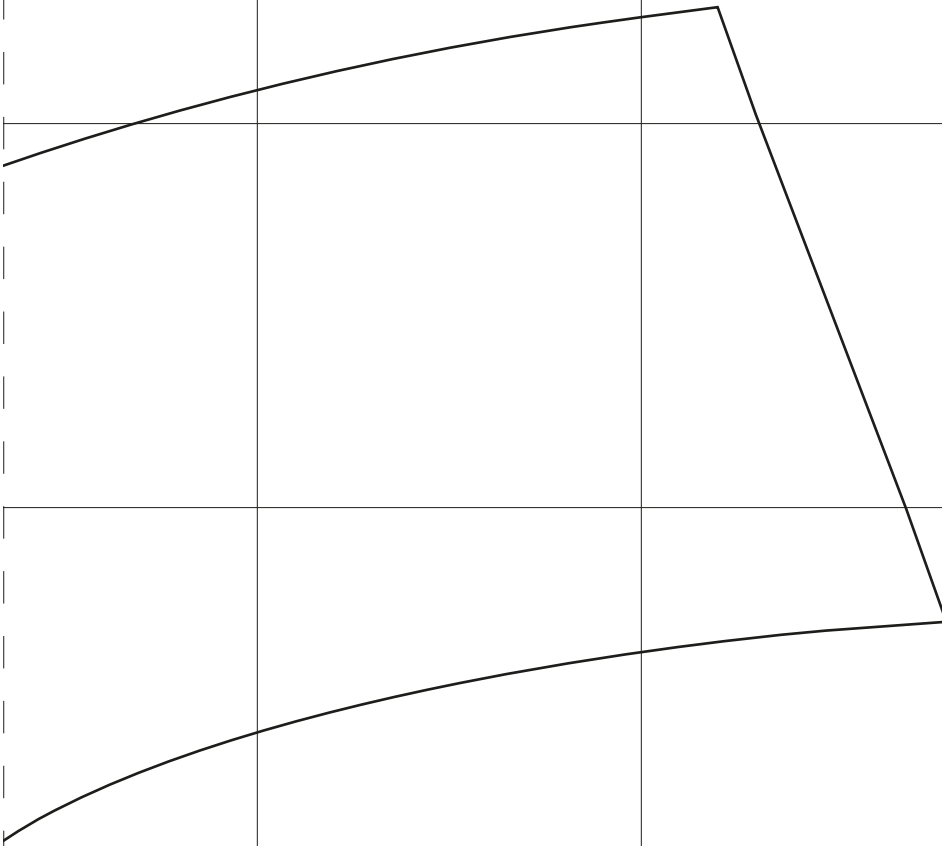

E4

E4

E5

E5

E5

E5

E6

E6

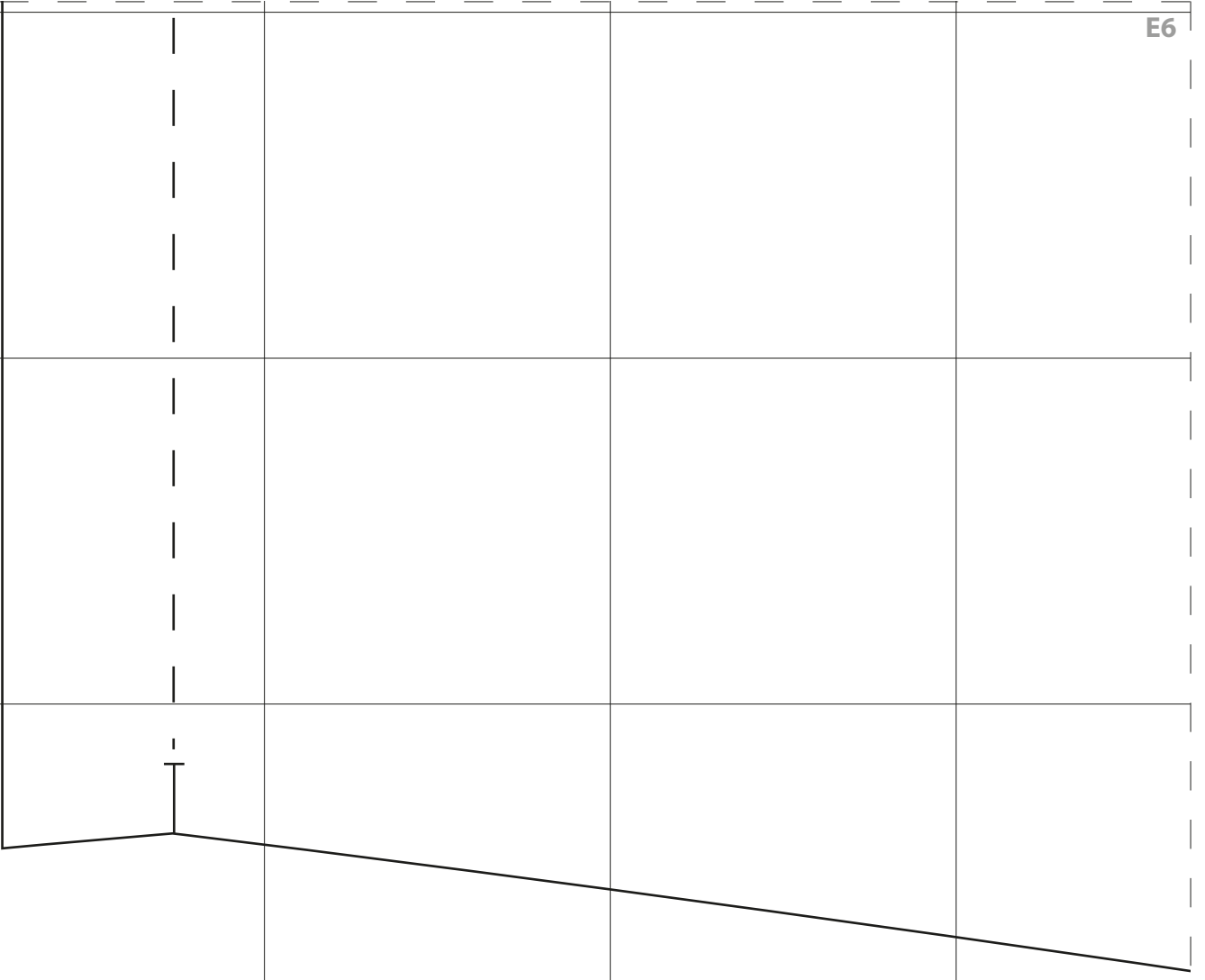

E6

E6

E7

E7

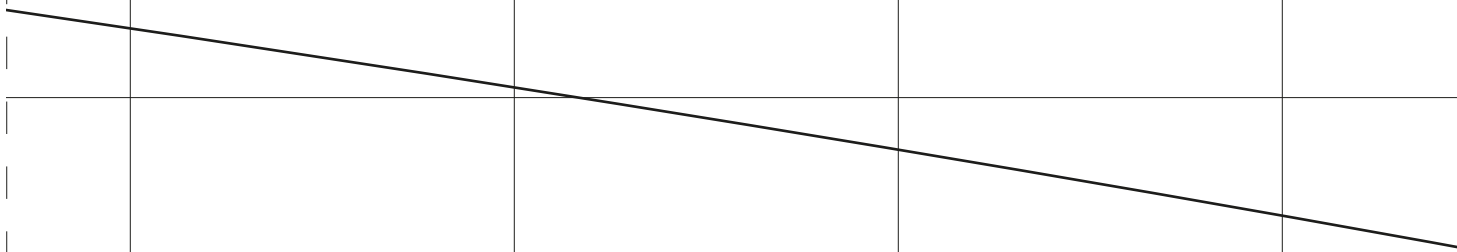

E7

E7

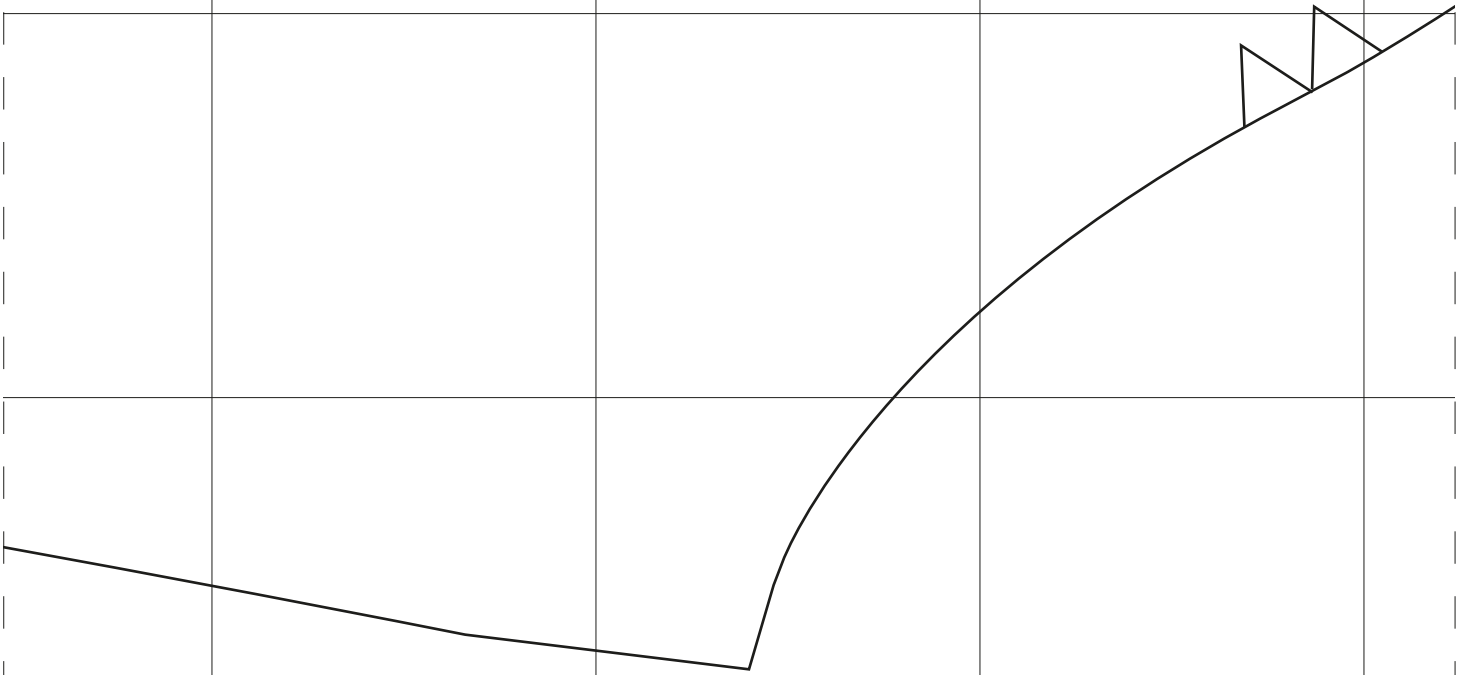

E9

E9

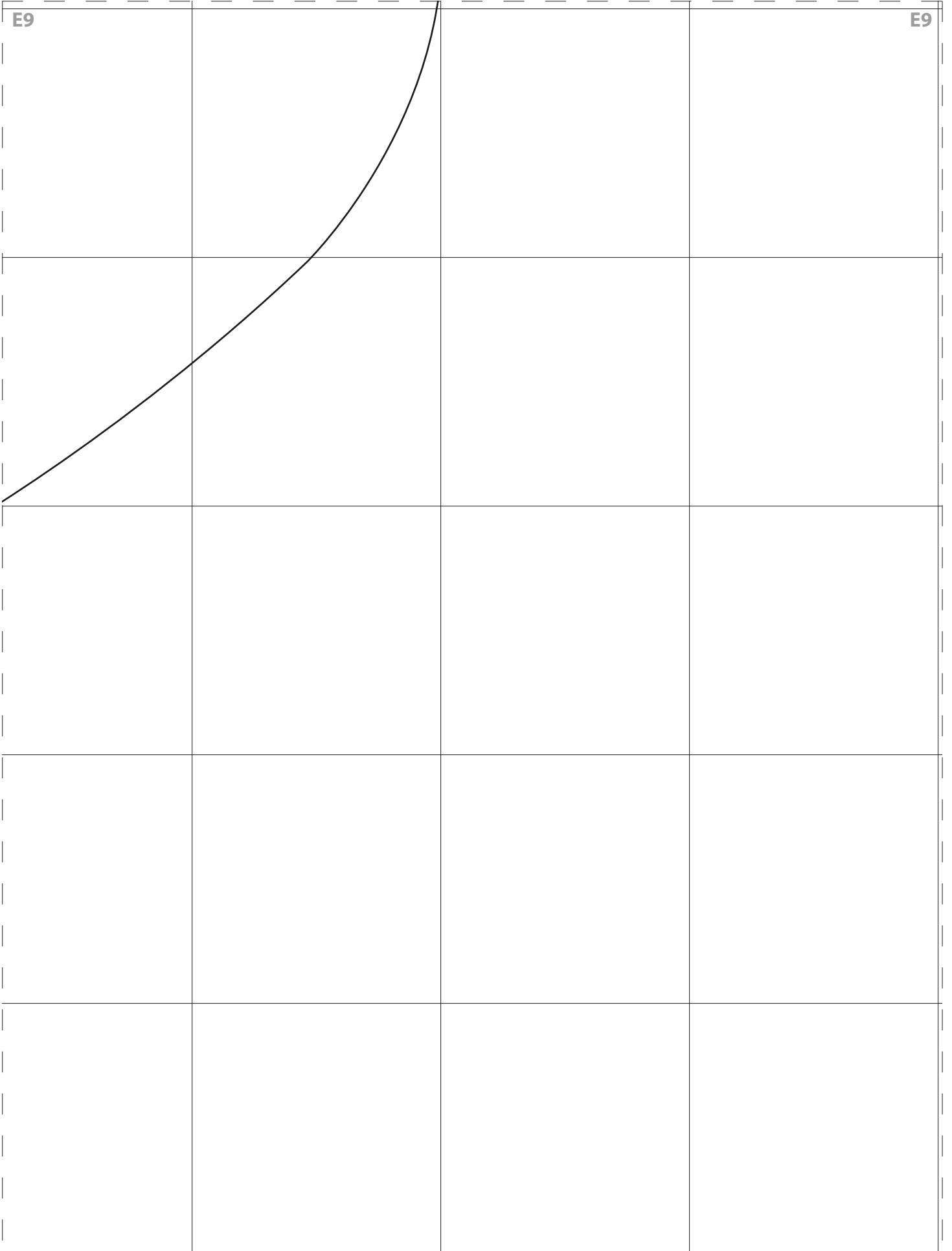

E9

E9