

CB

WAISTBAND  
Cut 1 fabric







LEFT HAND FRONT

CF



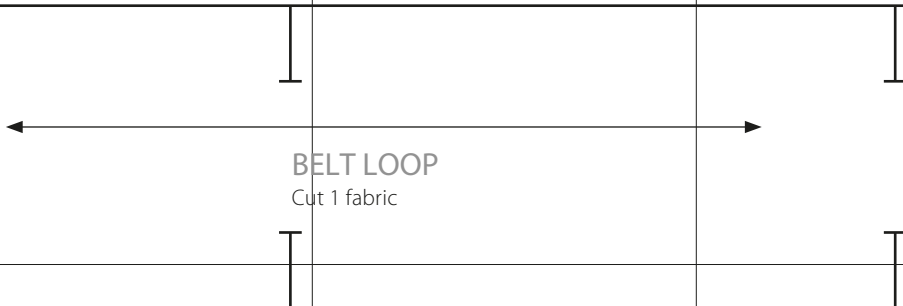
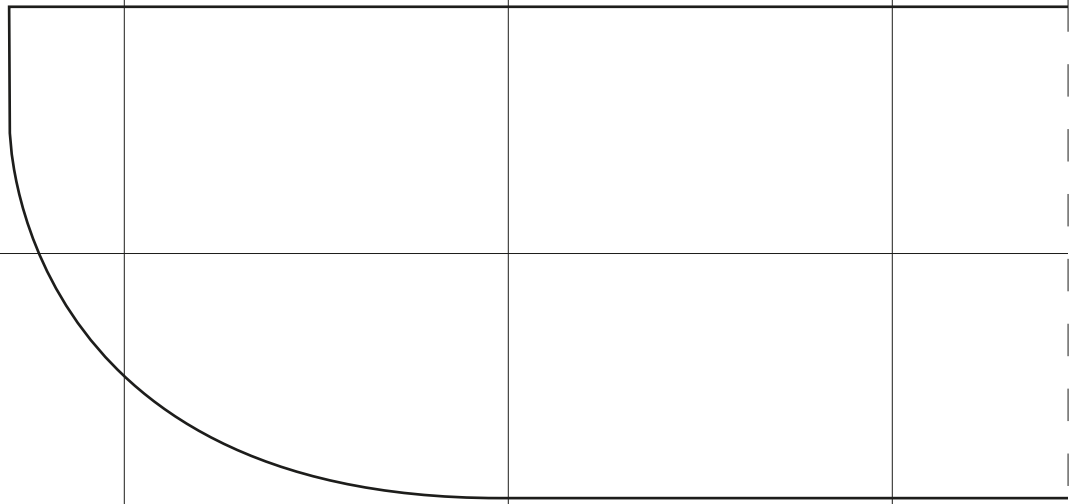

FLY FRONT FACING

Cut 1 fabric

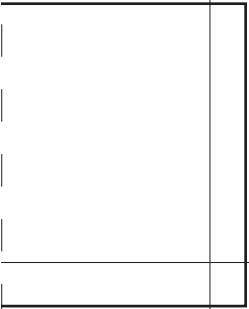



B1

B1

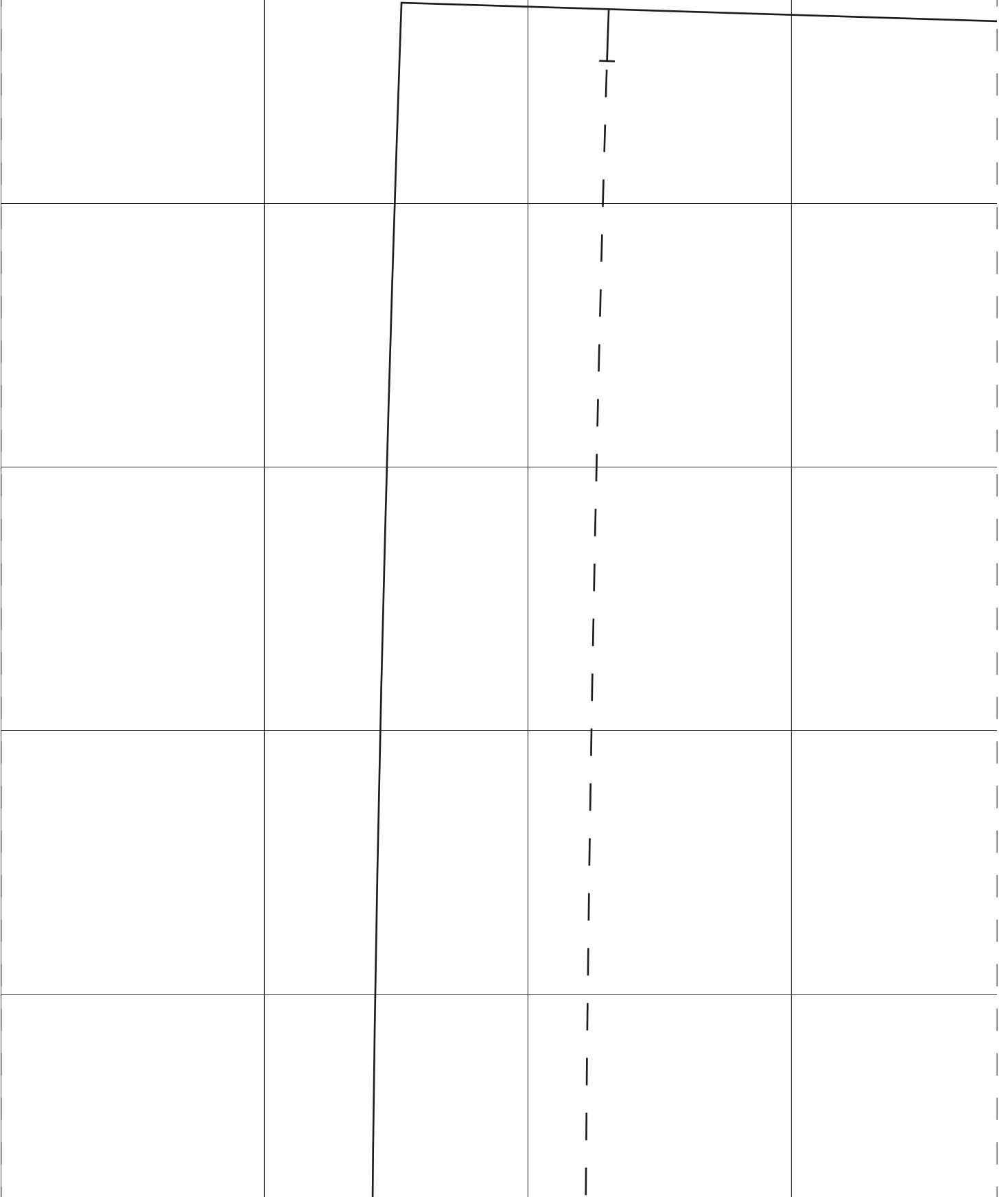

B1

B1

B2

B2



B2

B2

B3

B3

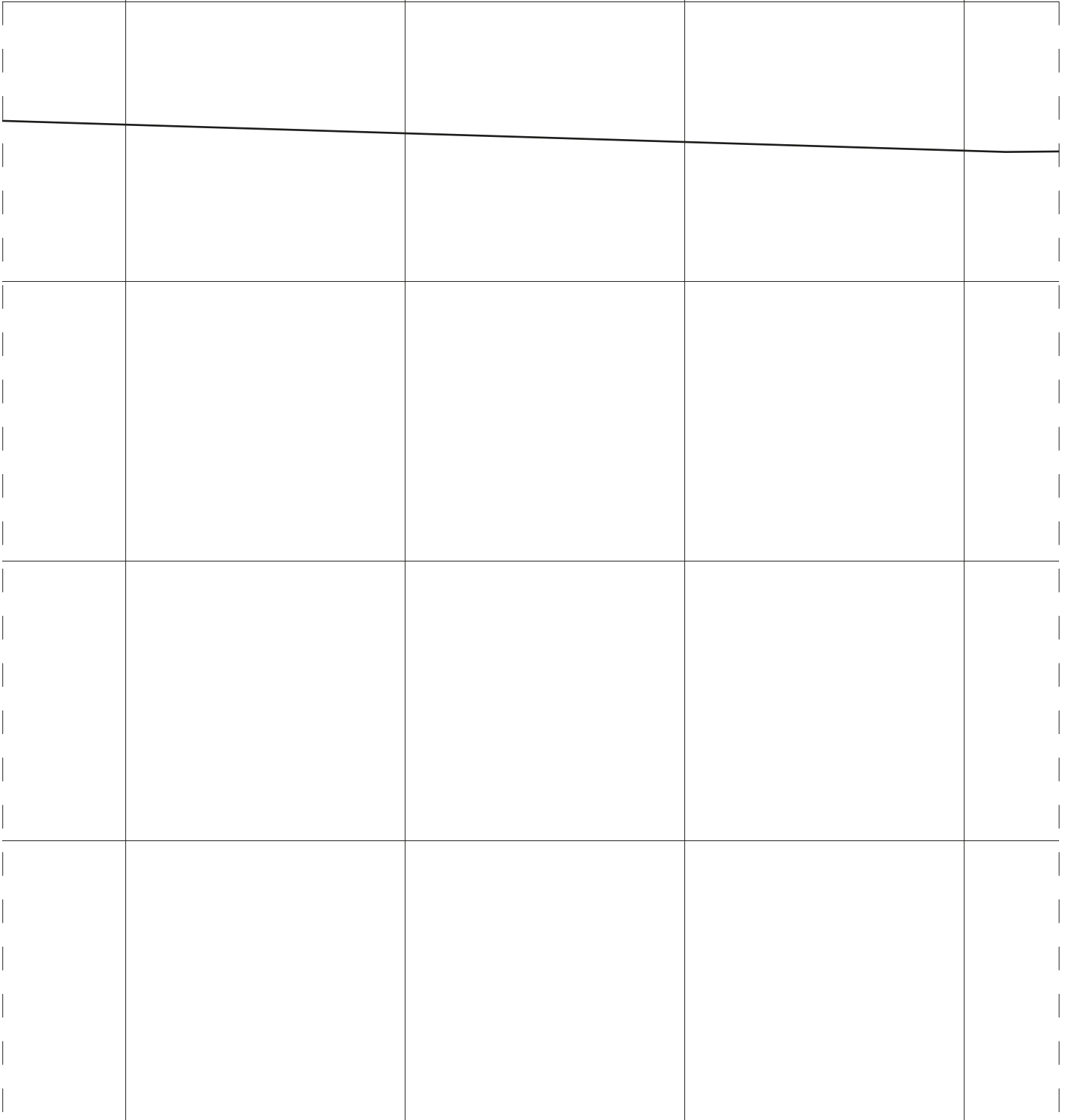

B3

B3

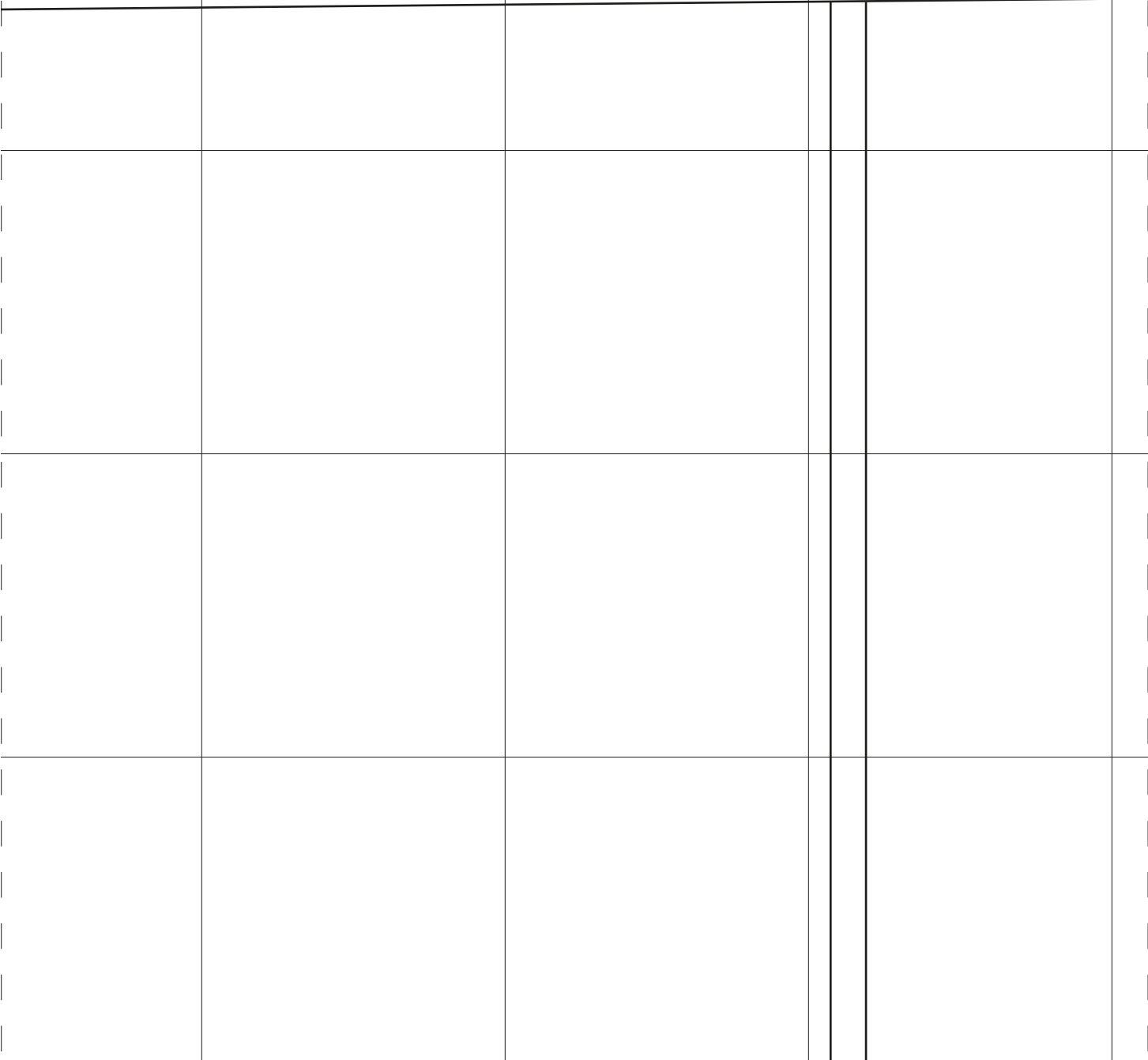



PANT BACK  
Cut 2 fabric

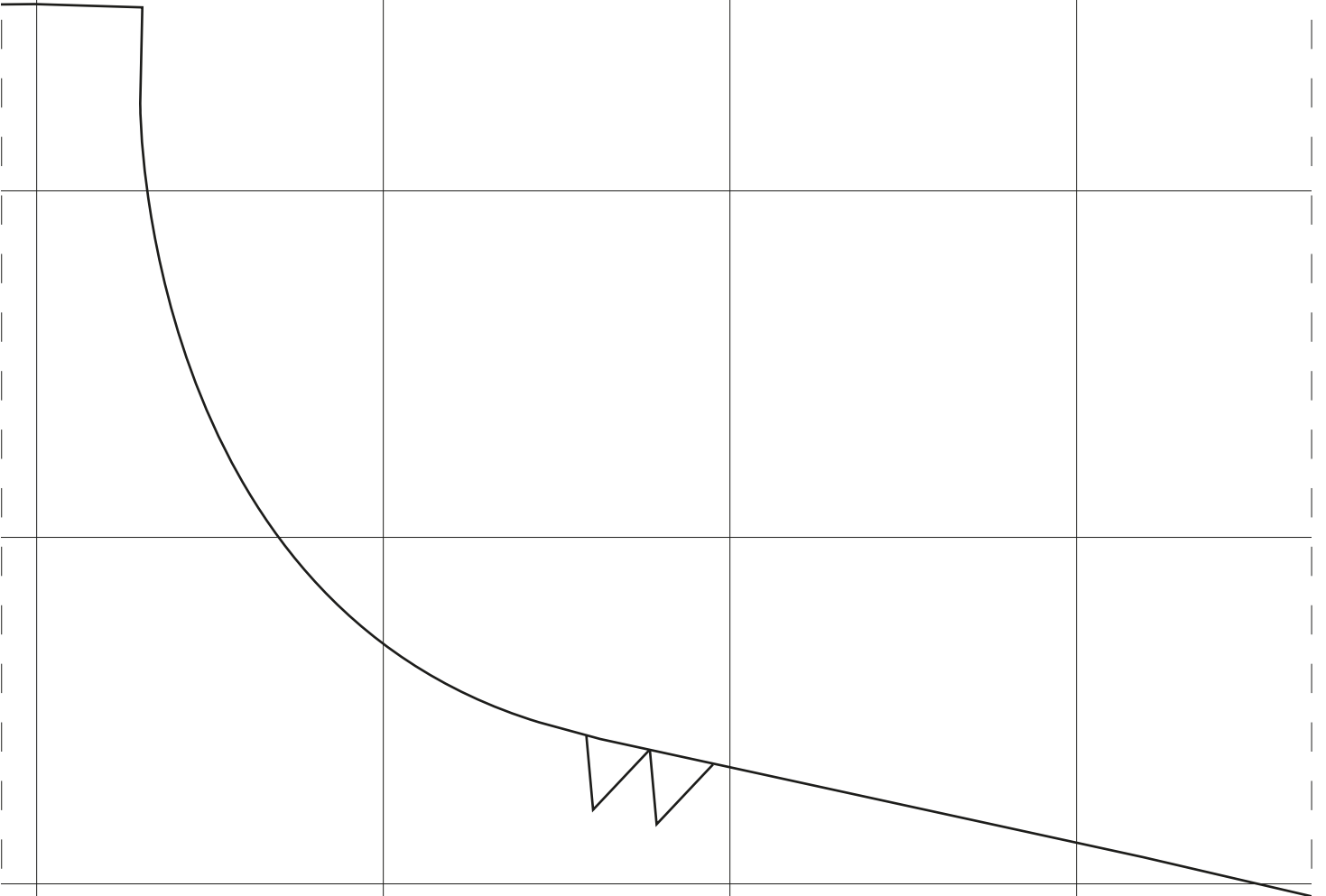

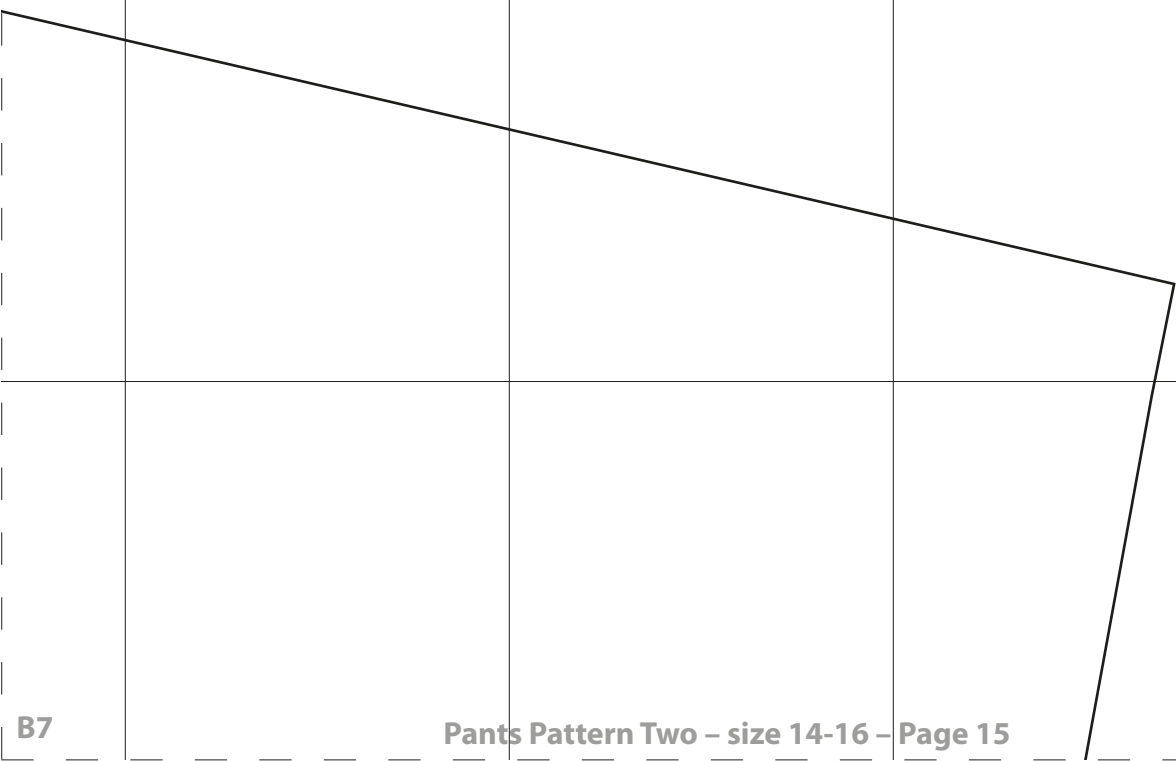

C1

C1

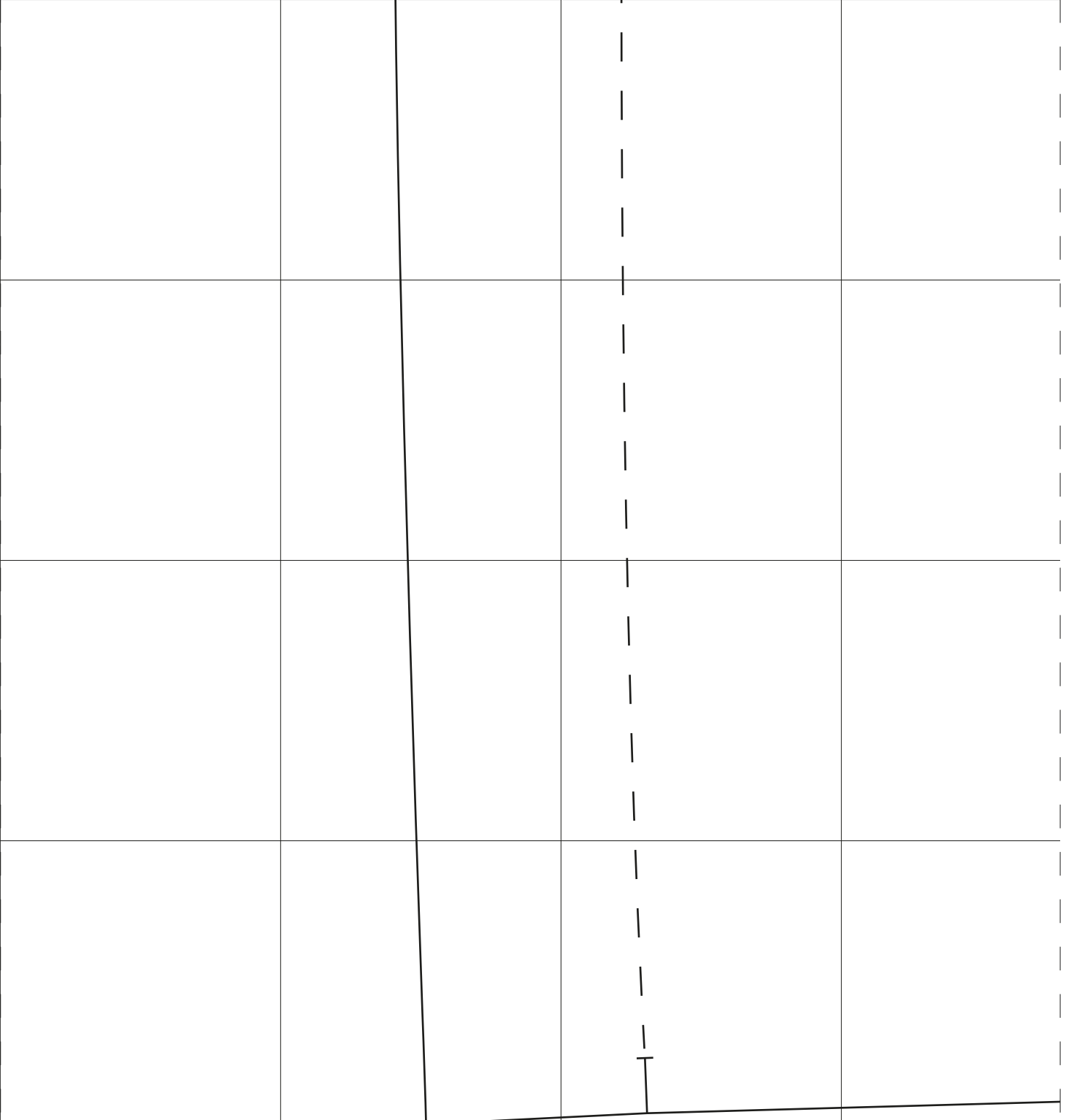

C1

C1



C2

C2

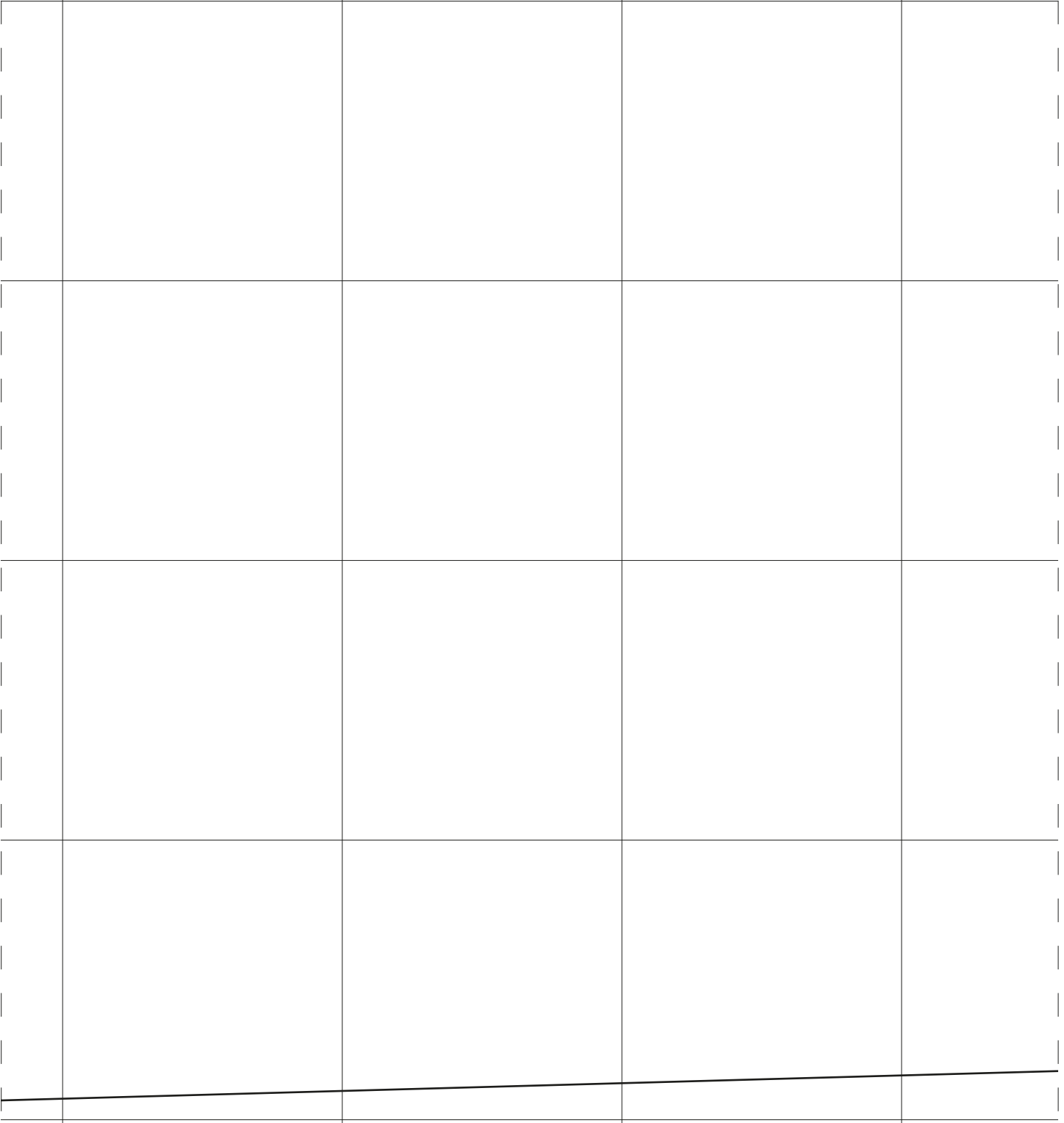

C2

C2

C3

C3

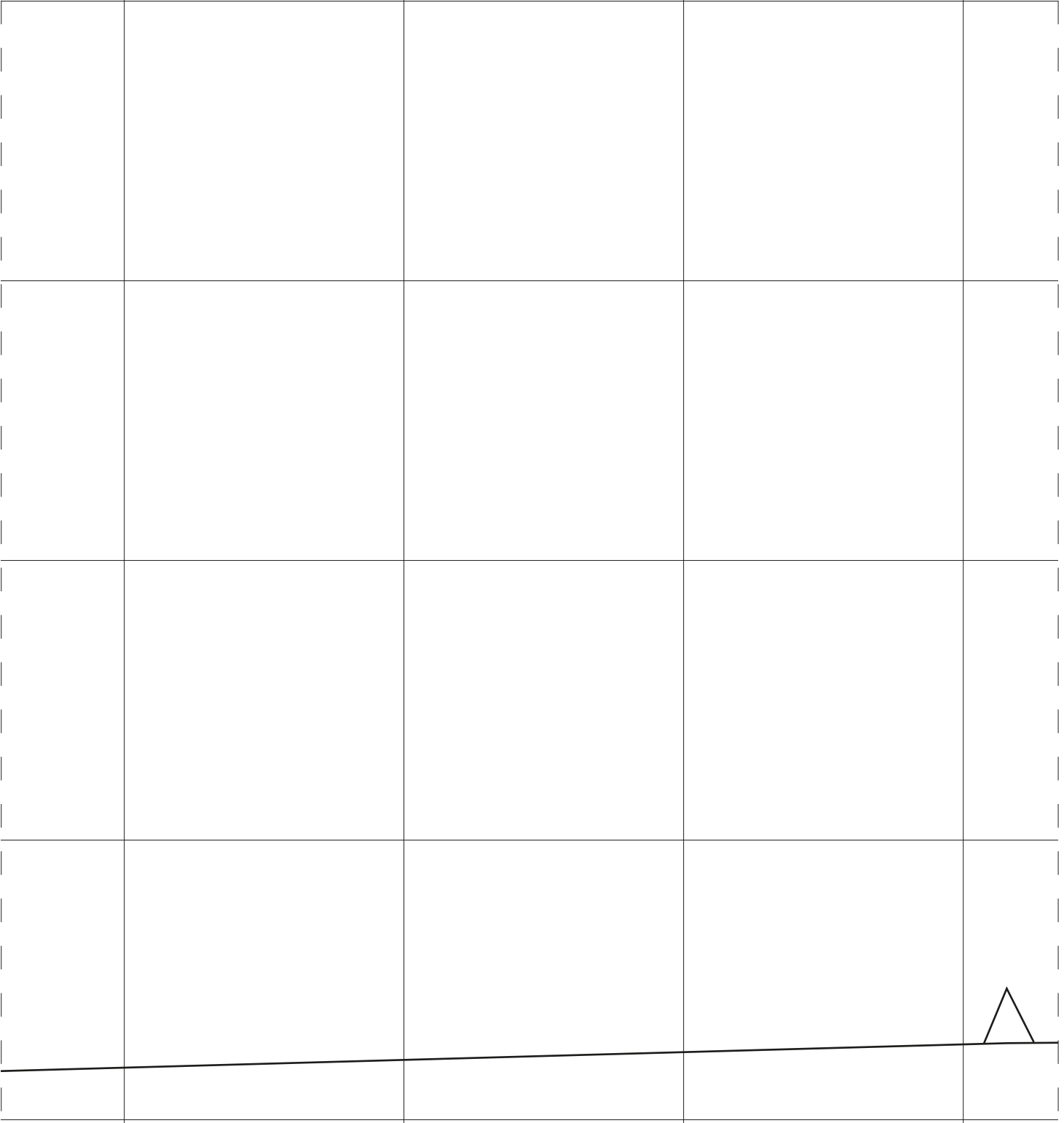

C3

C3

C4

C4

C4

C4

C5

C5

C5

C5

C6

C6



C6

C6

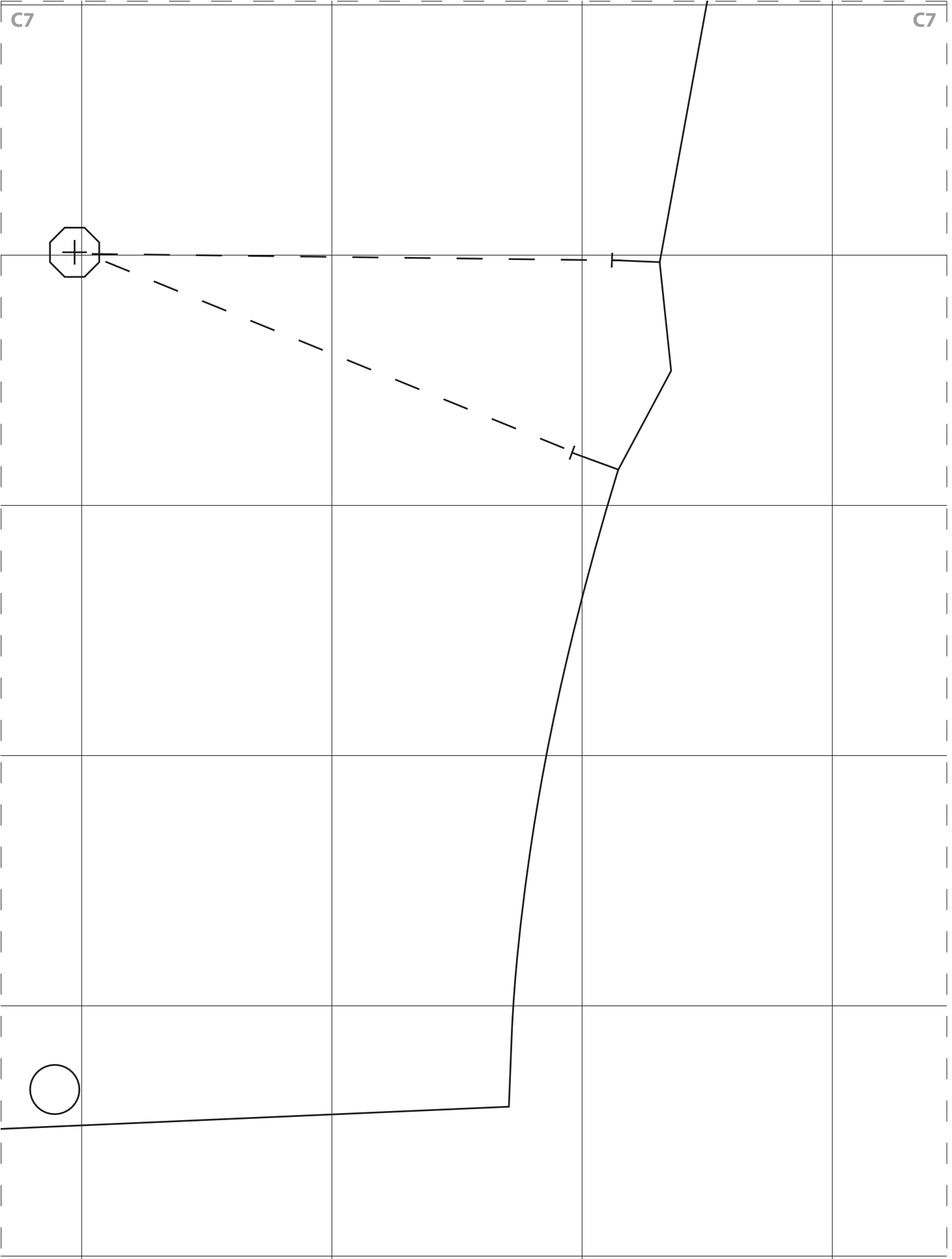

D1

D1

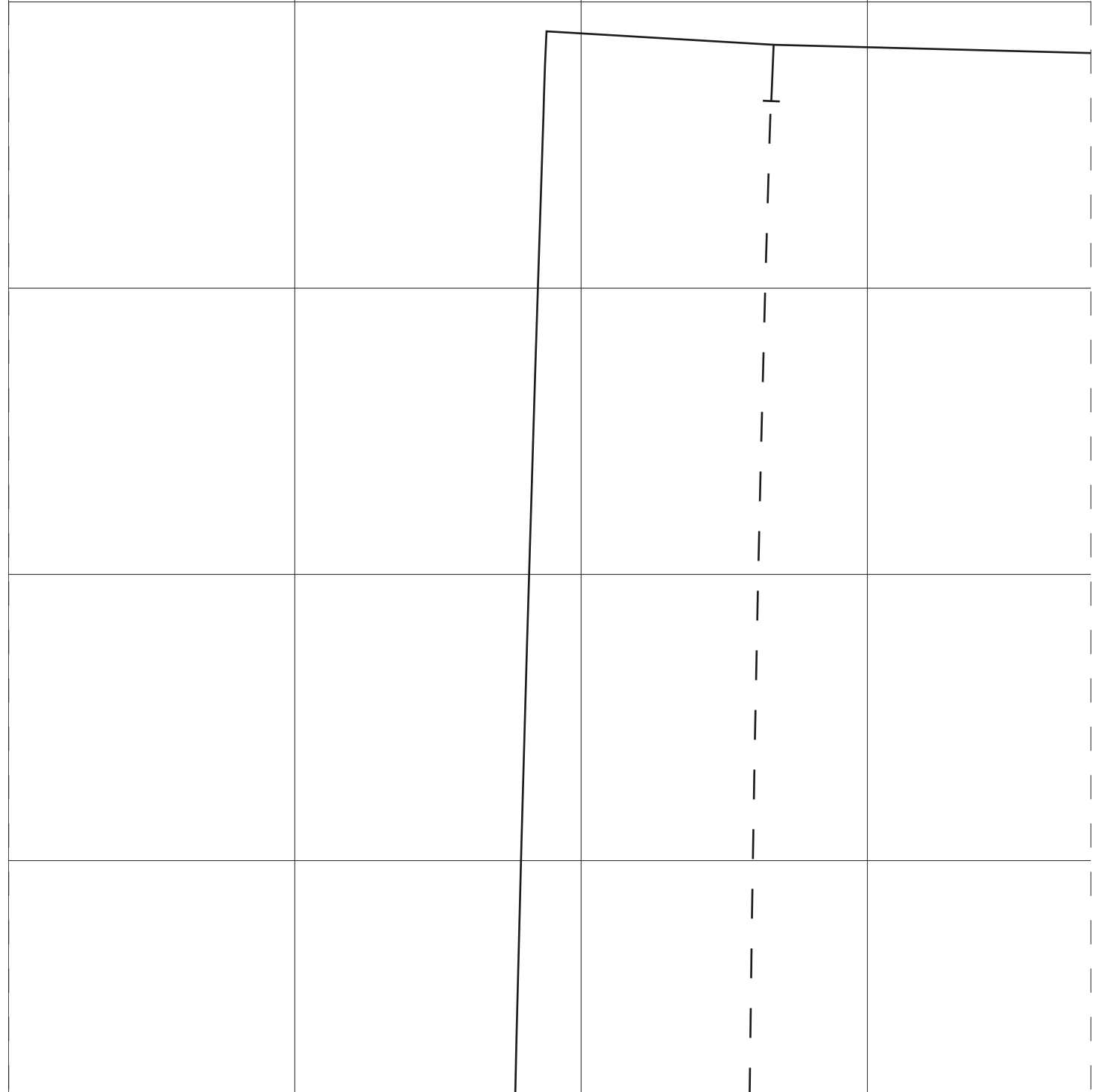

D1

D1

D2

D2



D2

D2



D3

D3



D3

D3

D4

D4

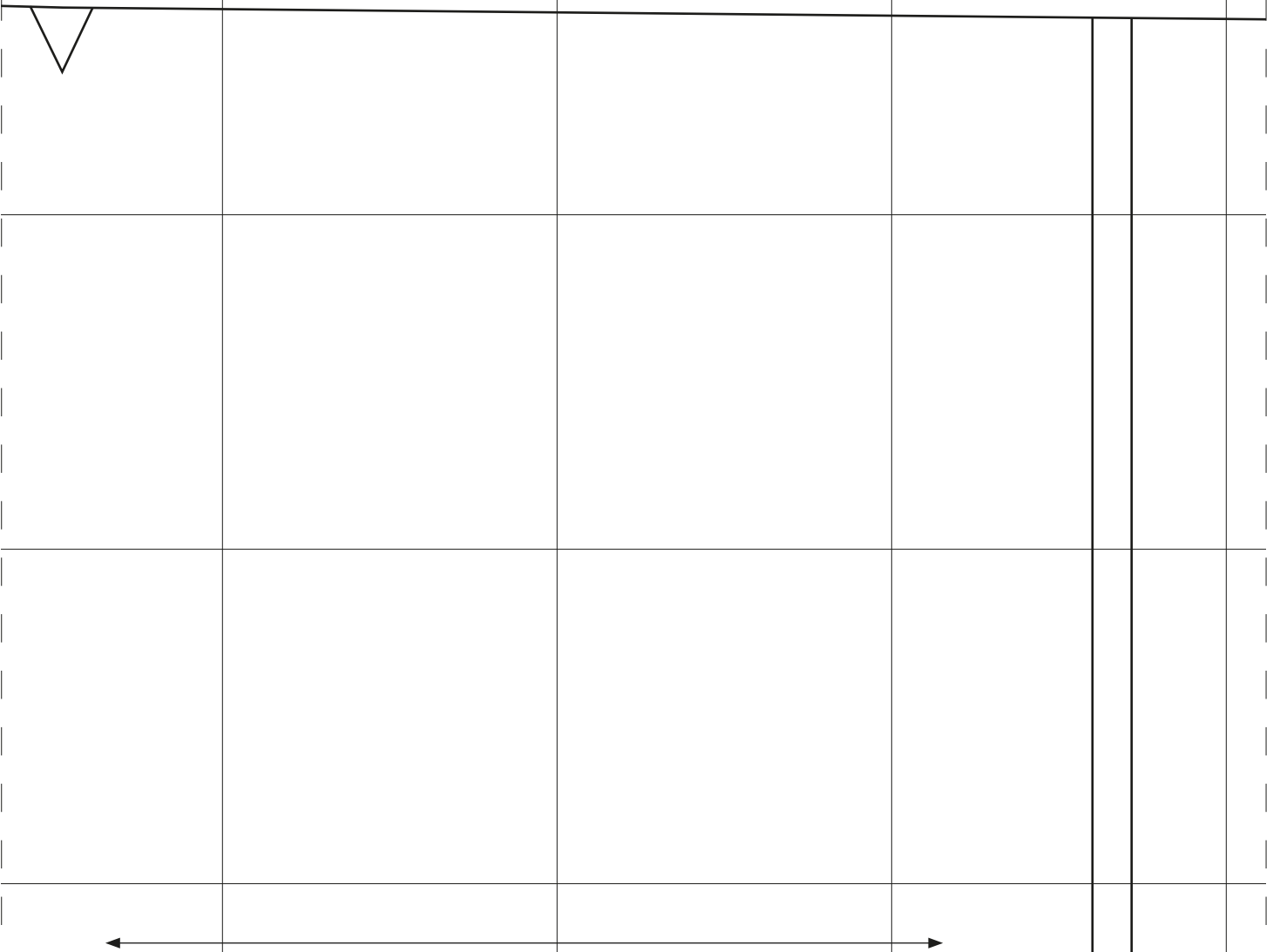

PANT FRONT  
Cut 2 fabric

D4

D4

D5

D5

D5

D5

D6

D6



D6

D6

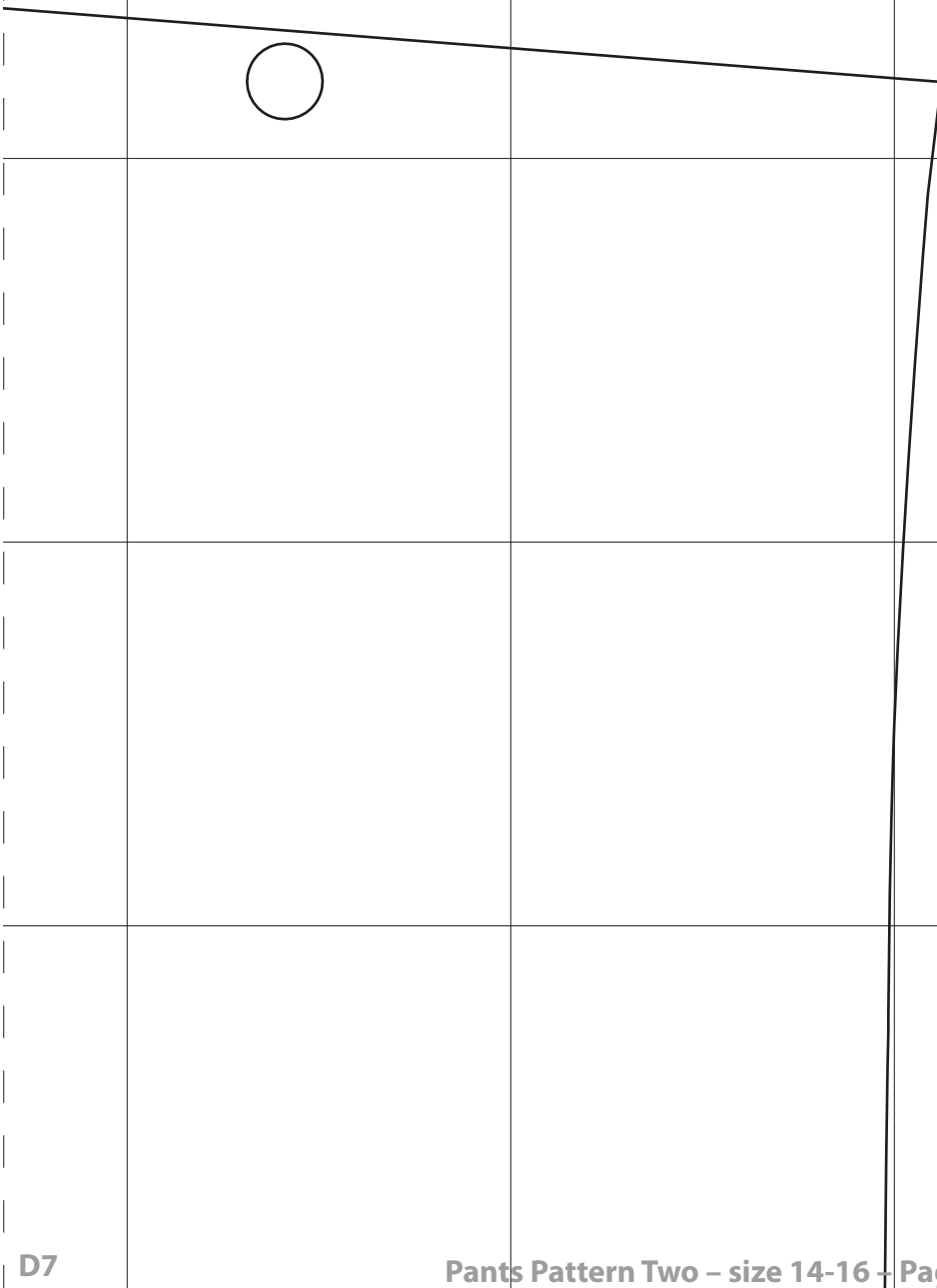

D8

D8

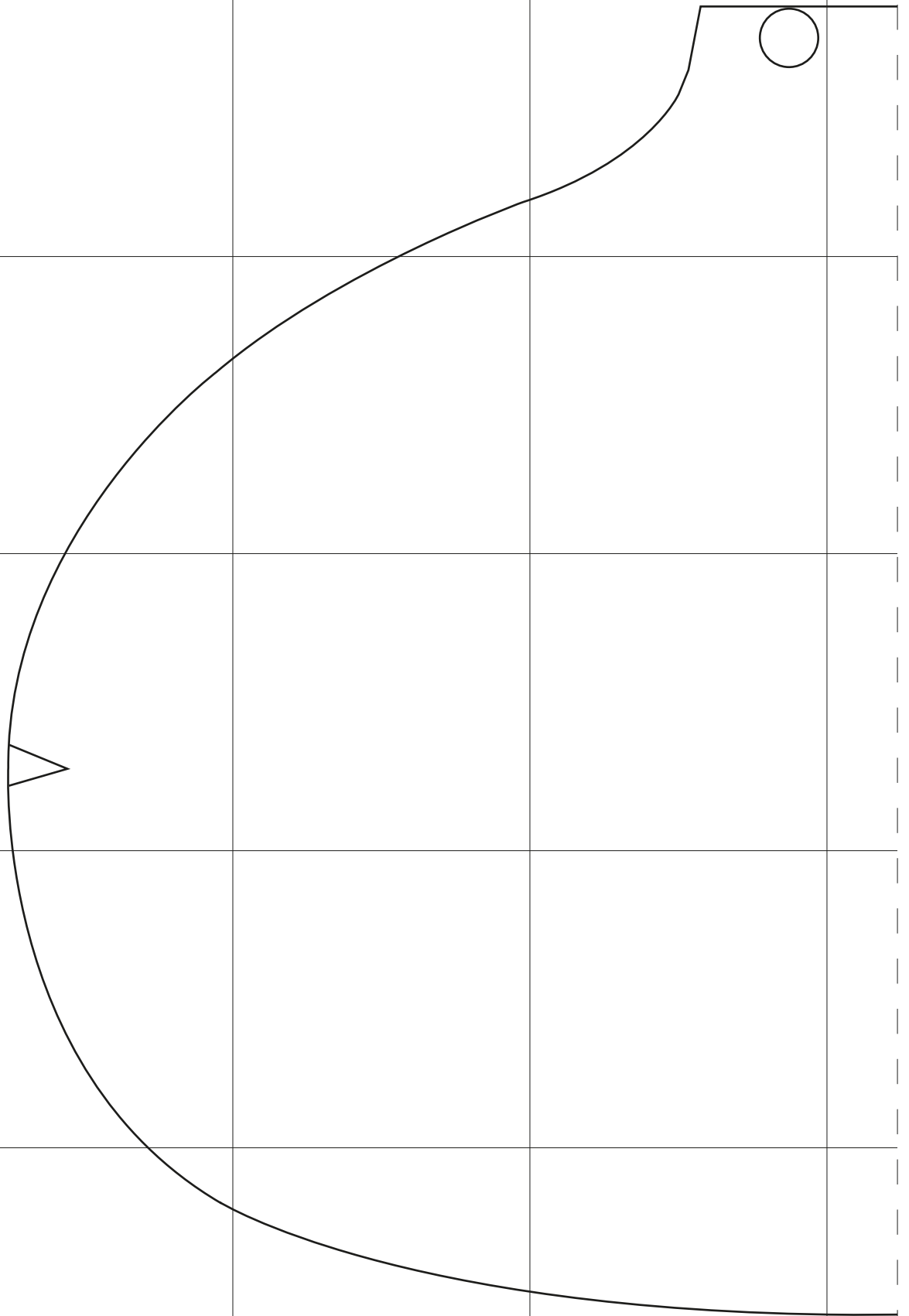

D8

D8

D9

D9

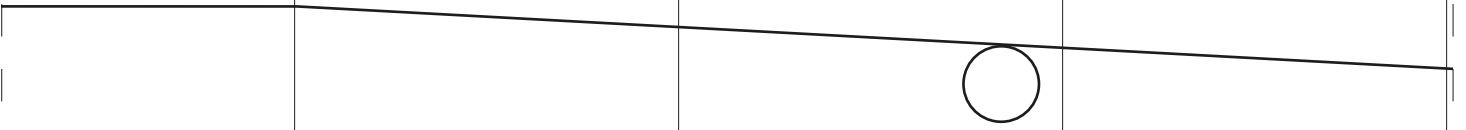

PANT  
POCKET  
Cut 2 fabric  
Cut 2 lining



D9

D9

D10



D10



E1

E1

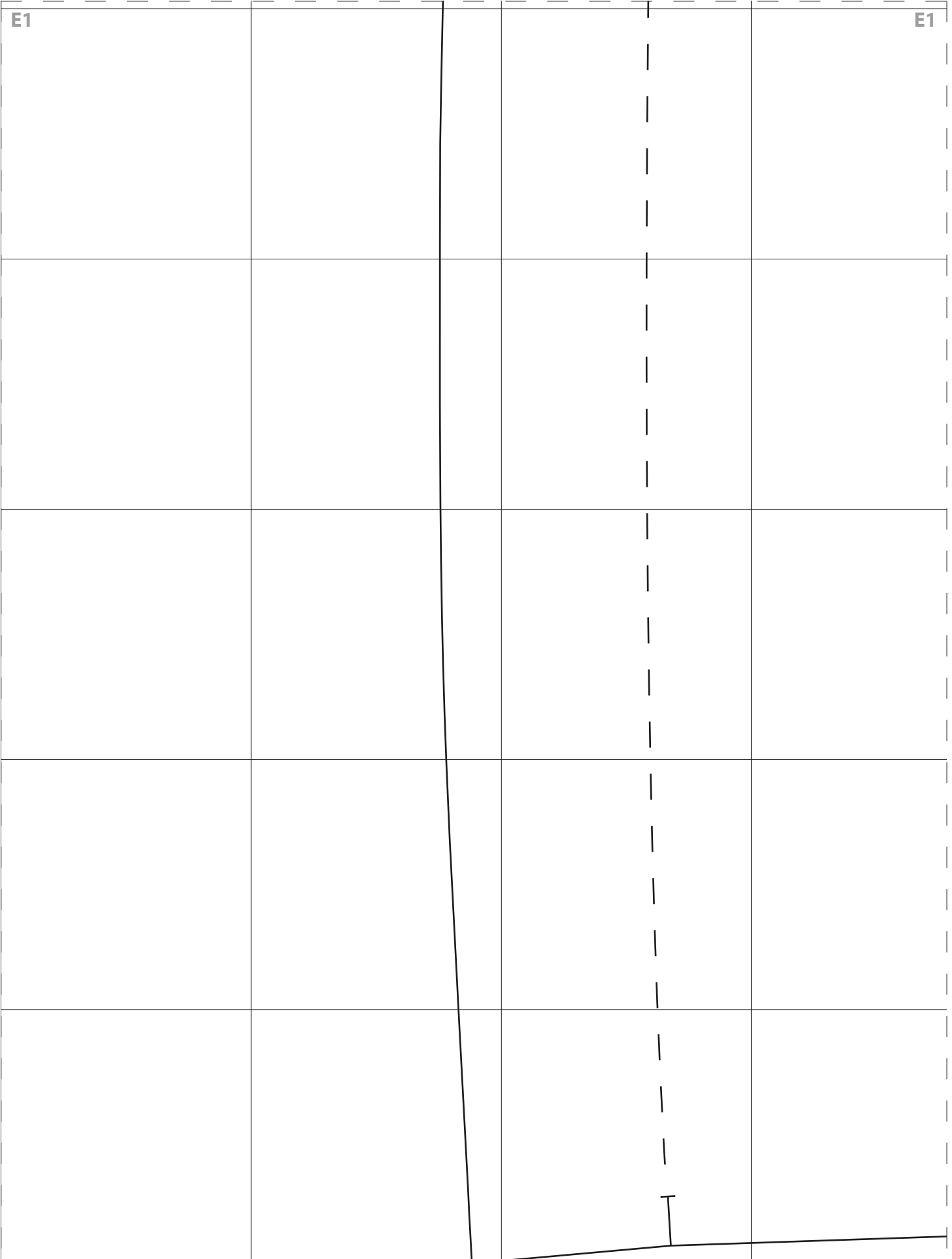

E1

E1

E2

E2

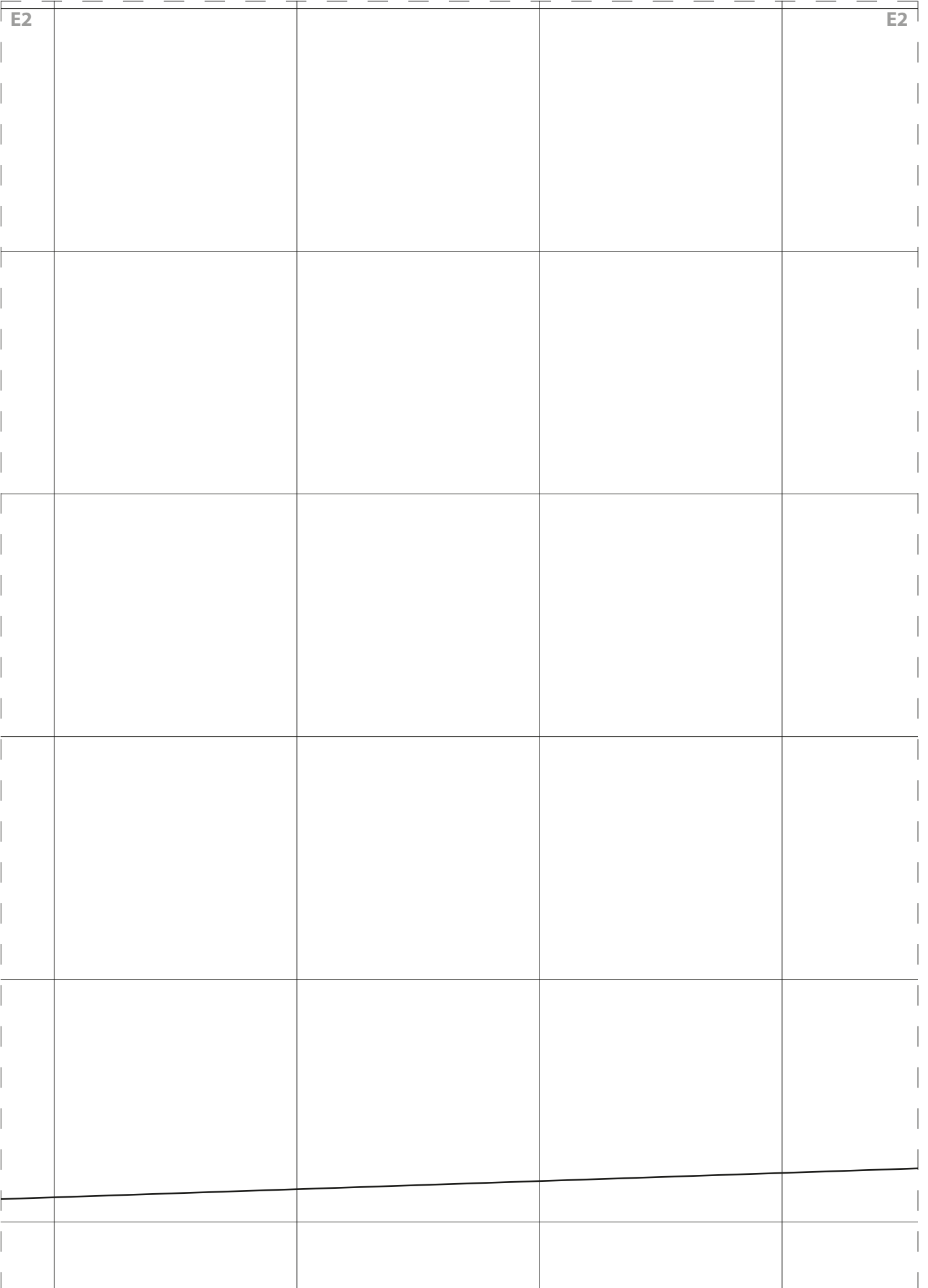

E2

E2

E3

E3

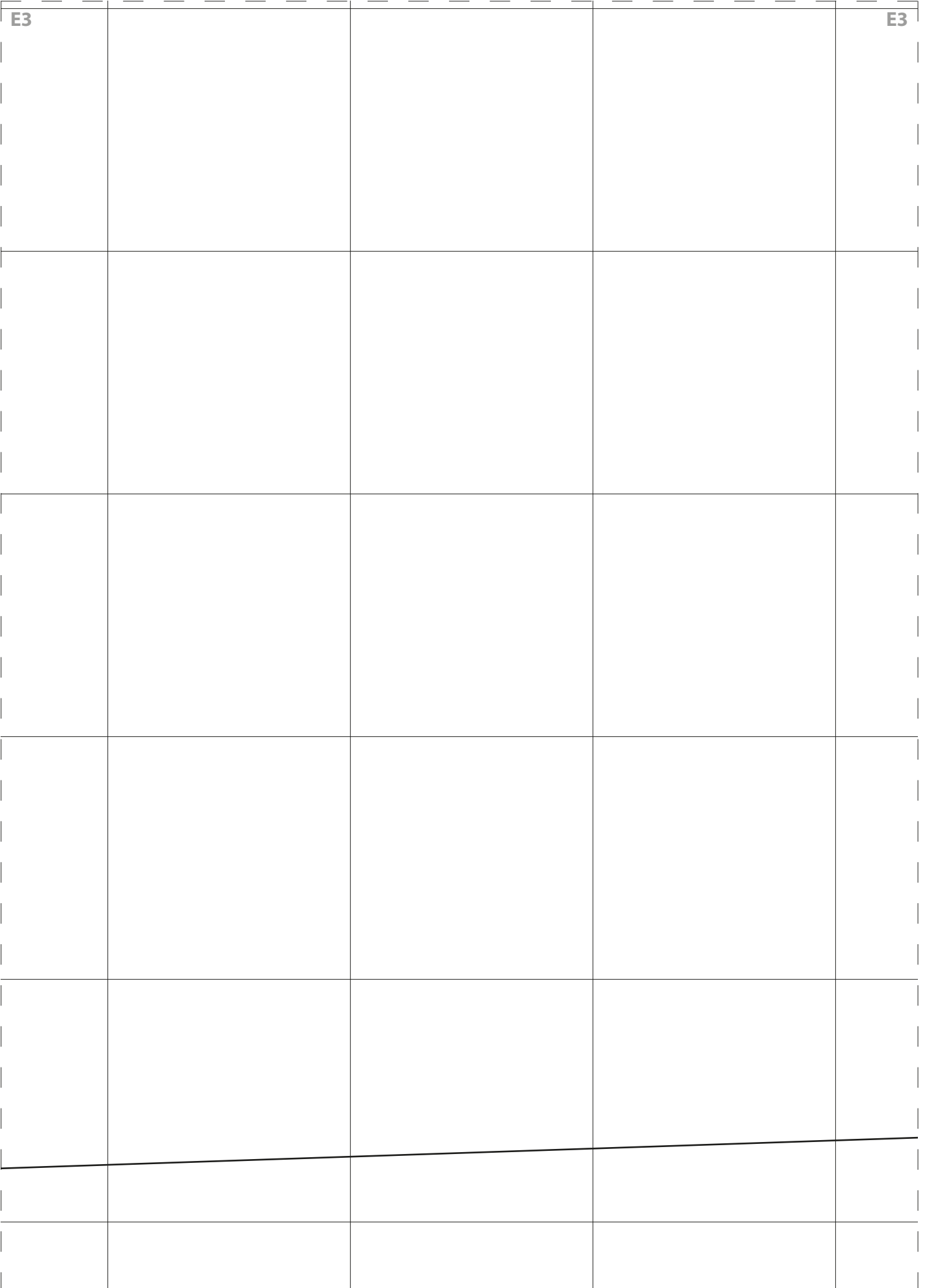

E3

E3

E4

E4

E4

E4



E6

E6

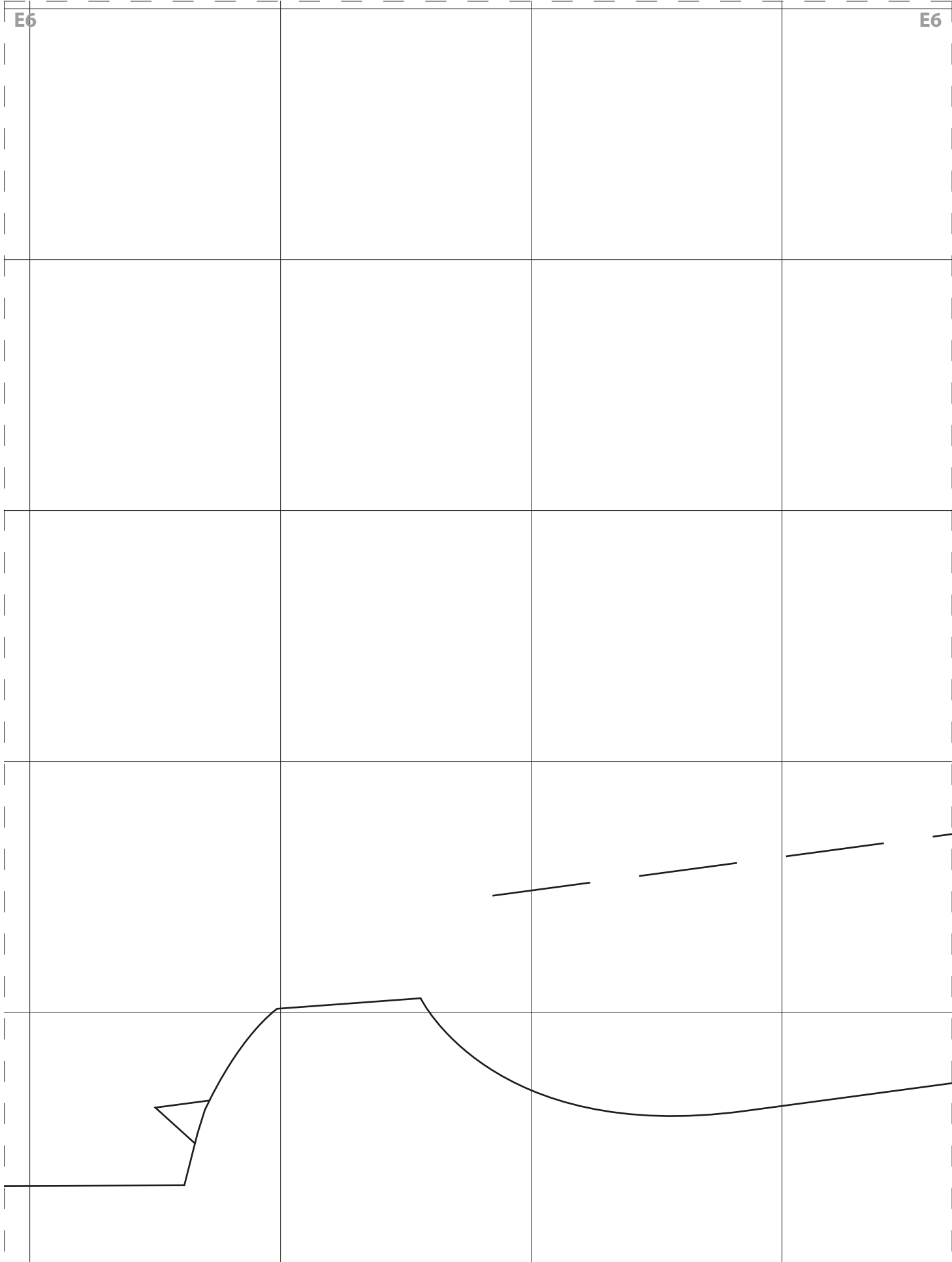

E6

E6

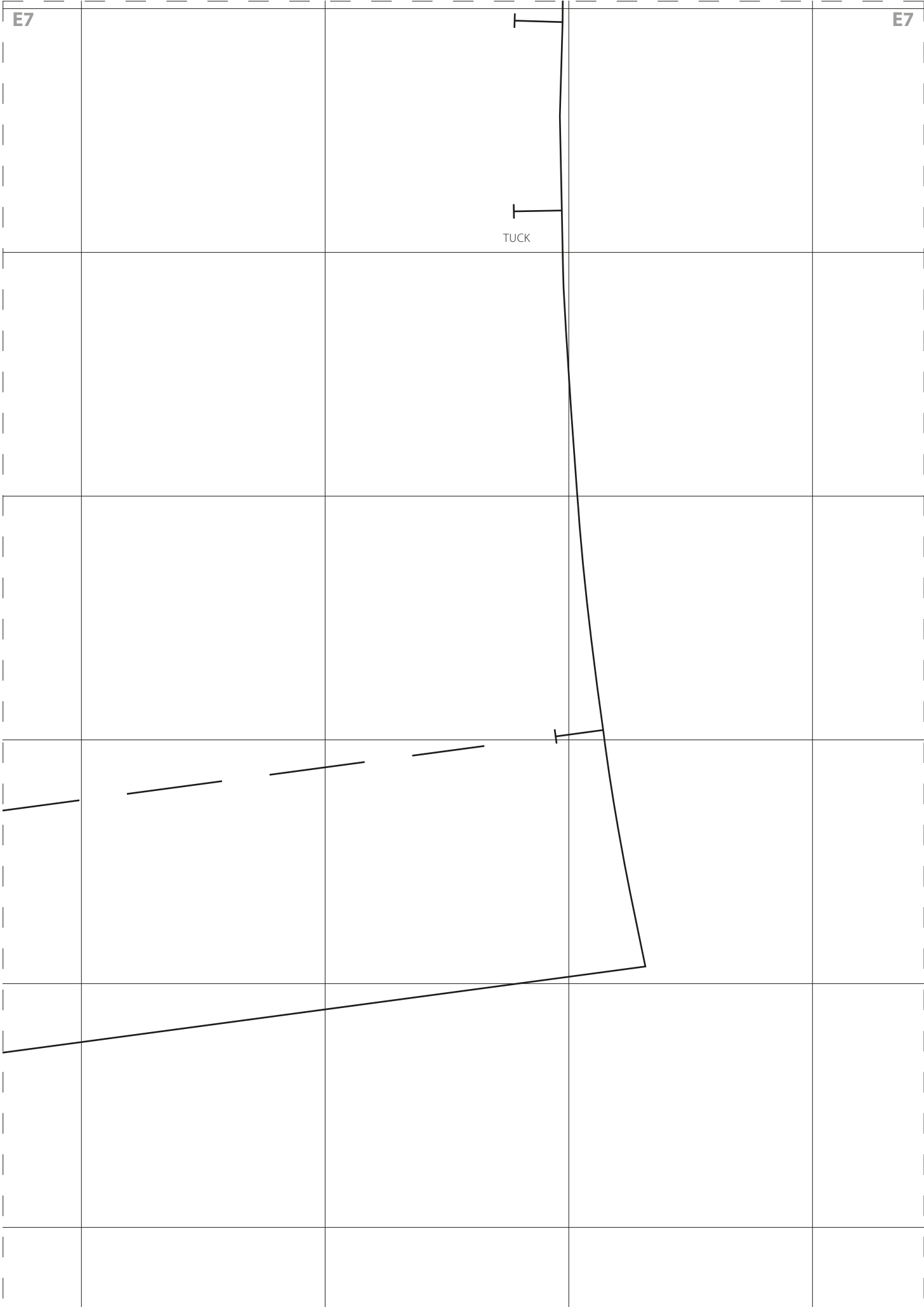

TUCK

TUCK