

A1

A1

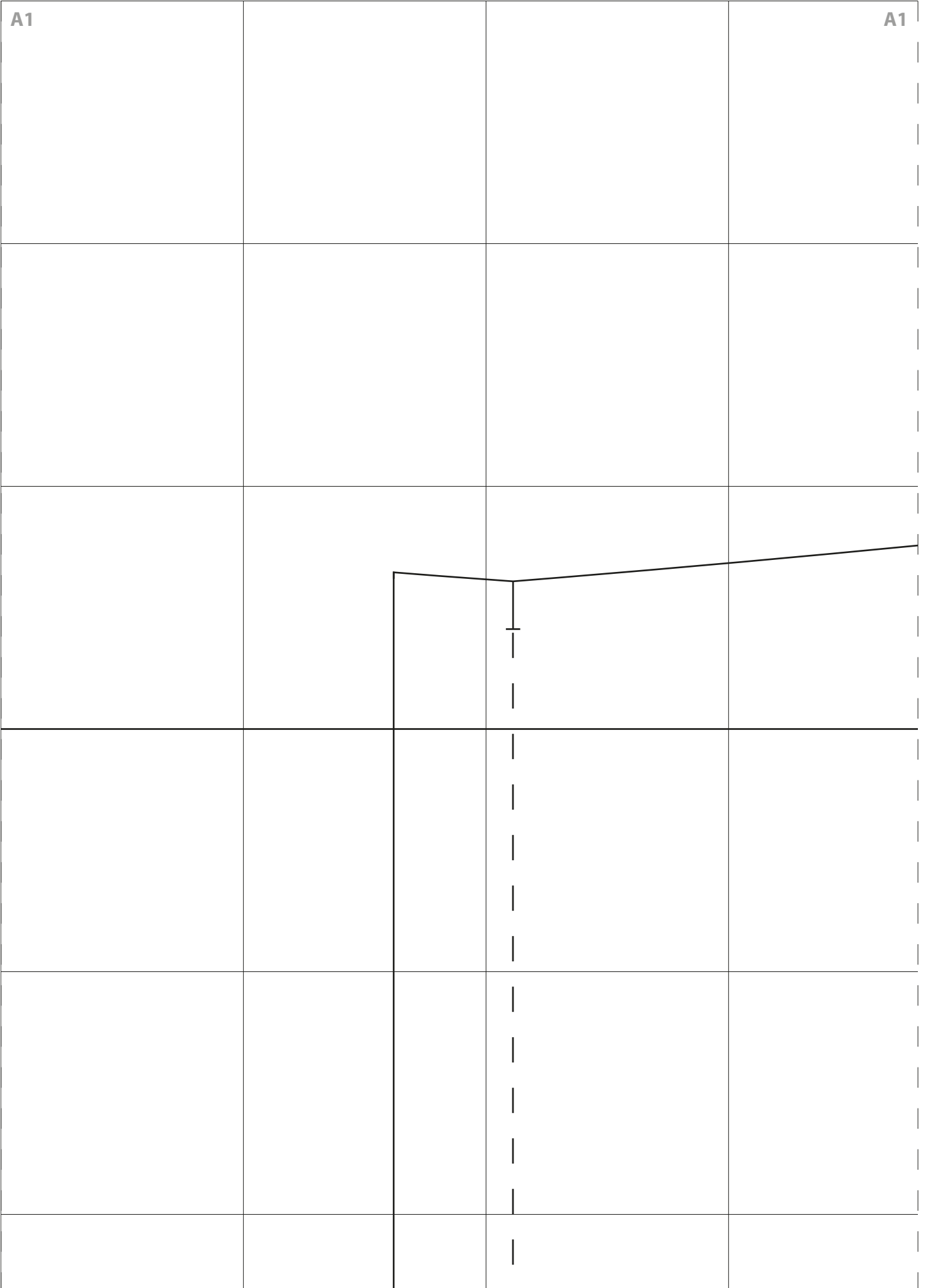

A1

A1



SLEEVE
Cut 2 fabric



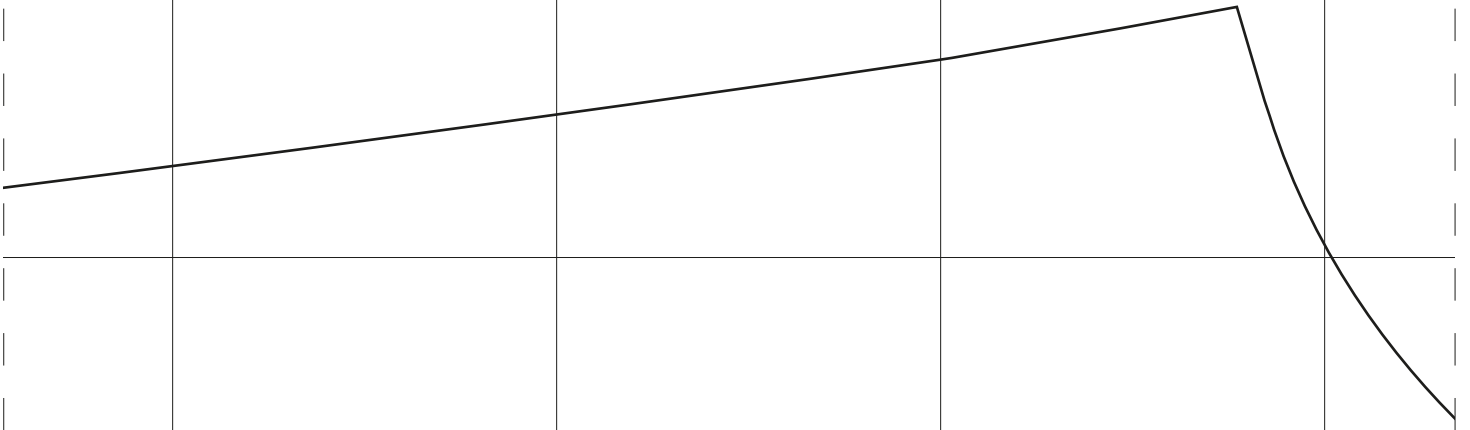

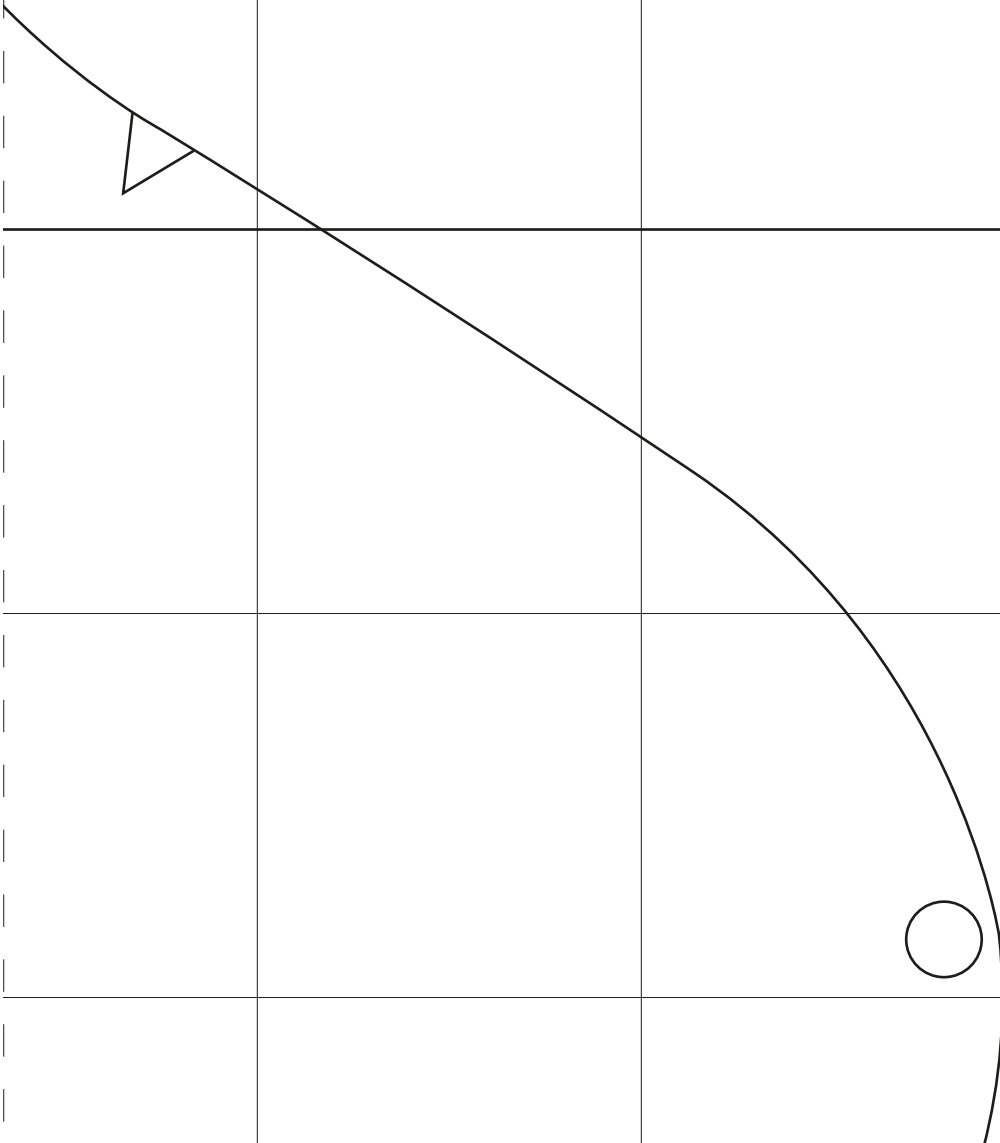

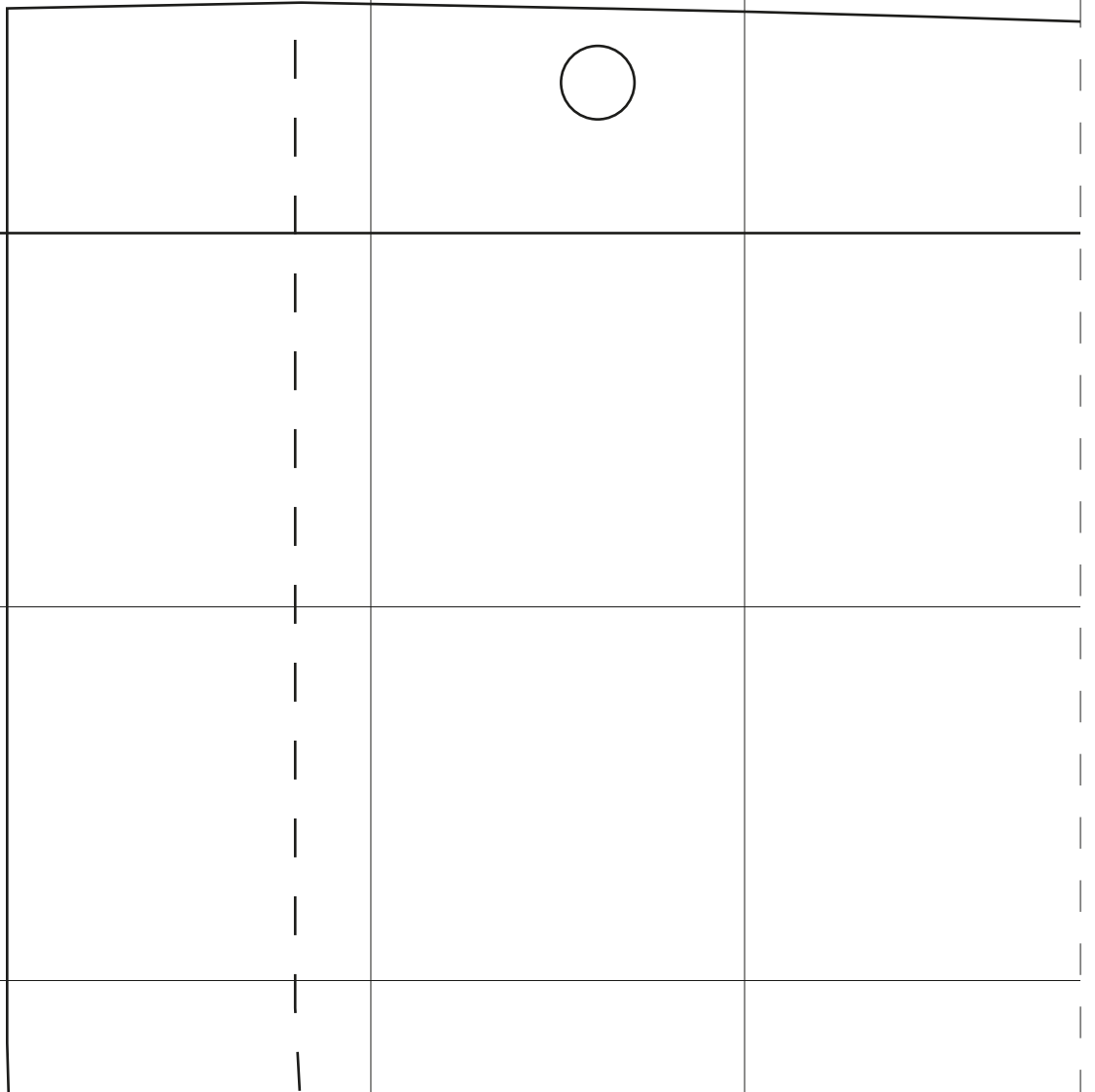

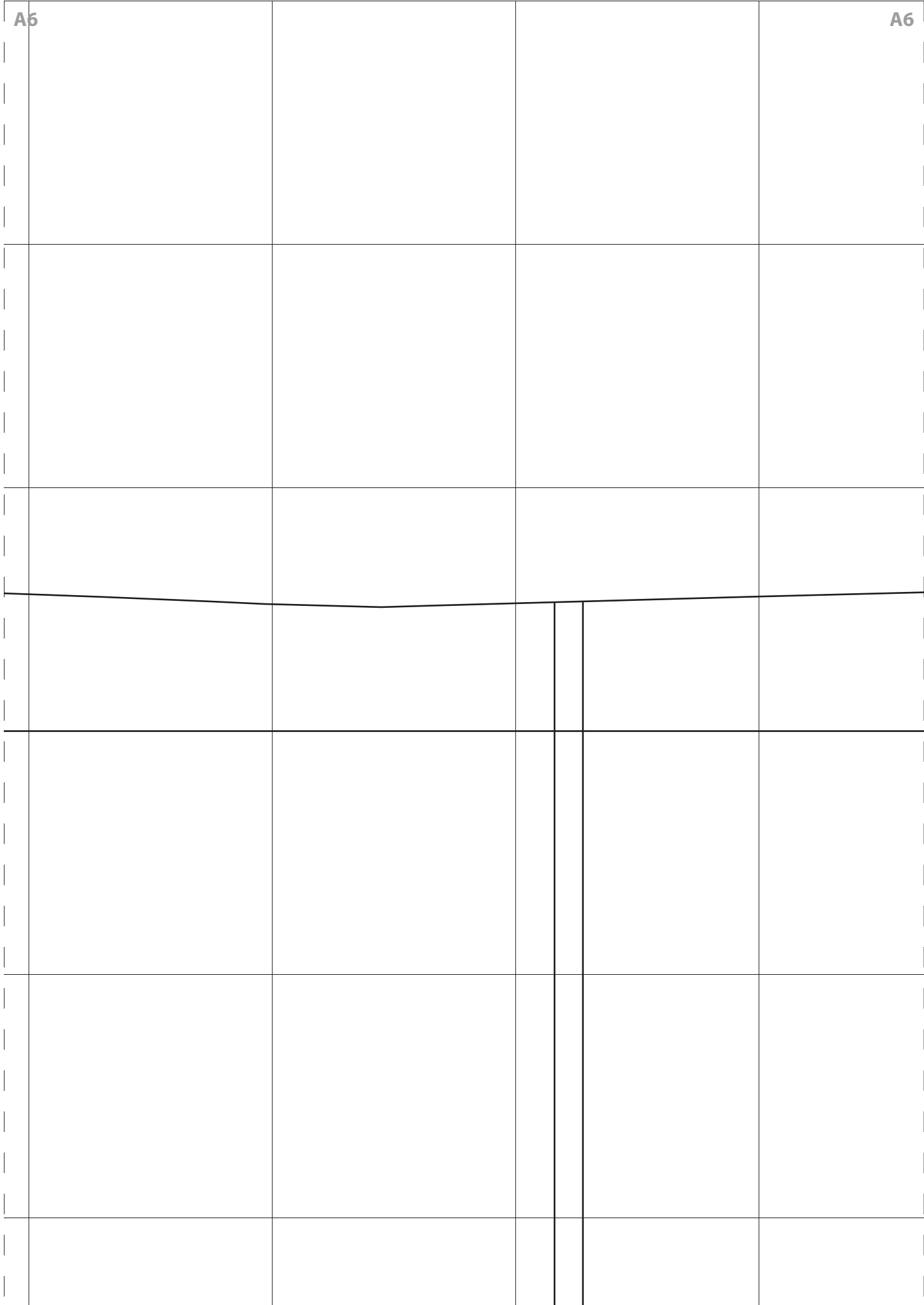

CB

TOP BACK
Cut 2 fabric



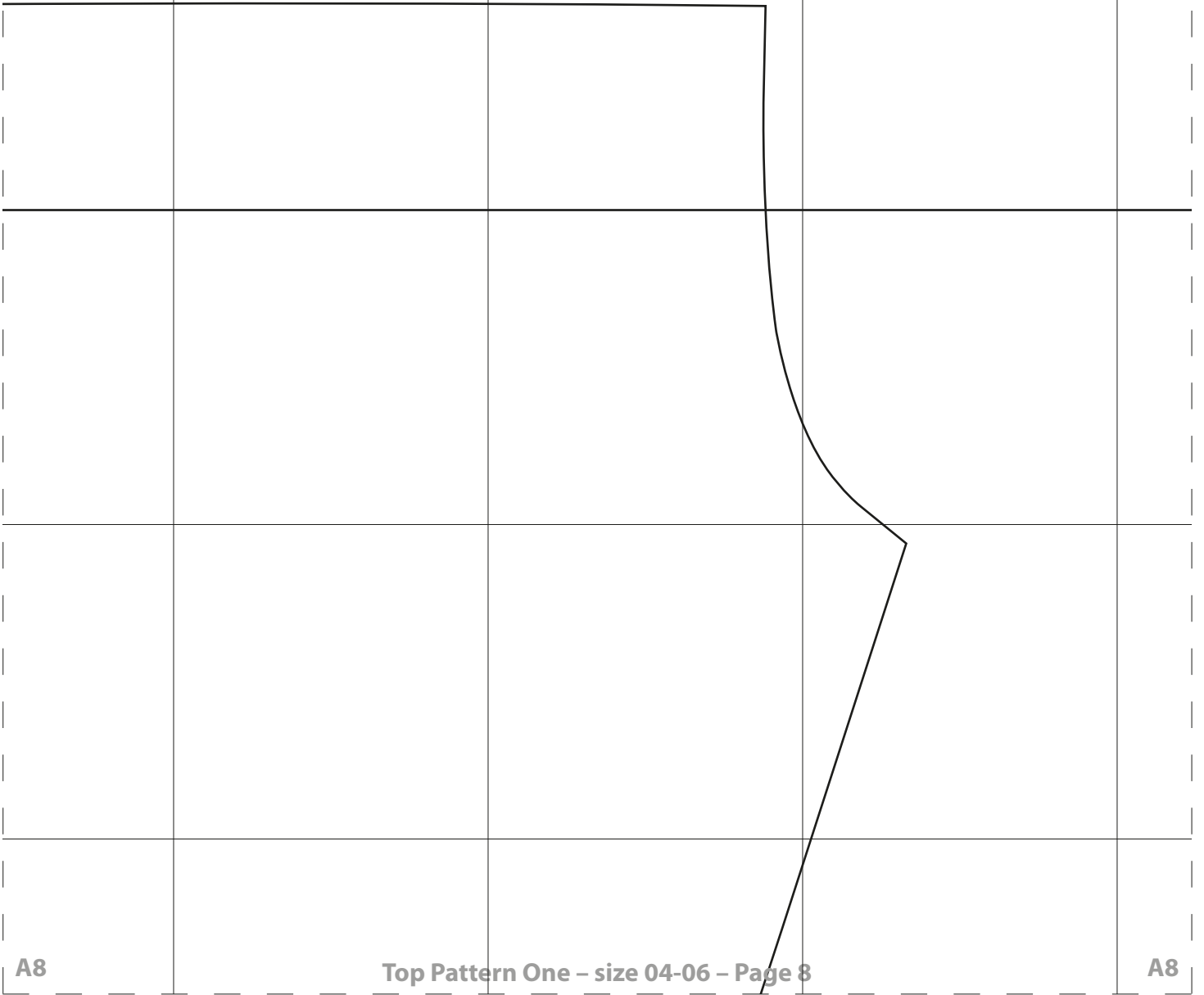

B1

B1

T

B1

B1

B2

B2

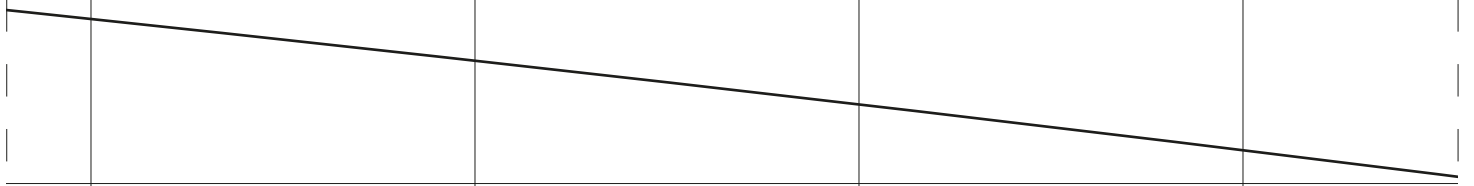

B2

B2

B3

B3

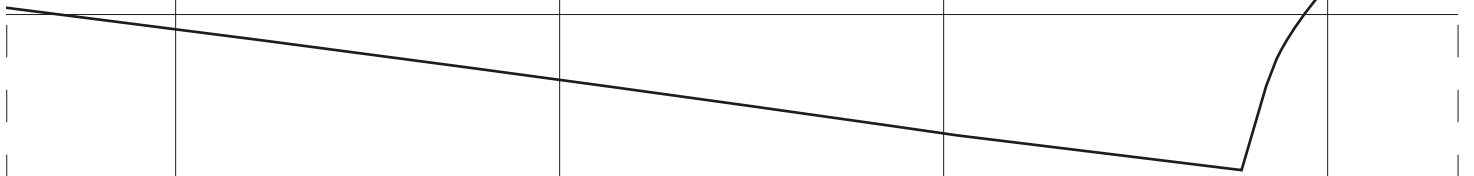

B3

B3

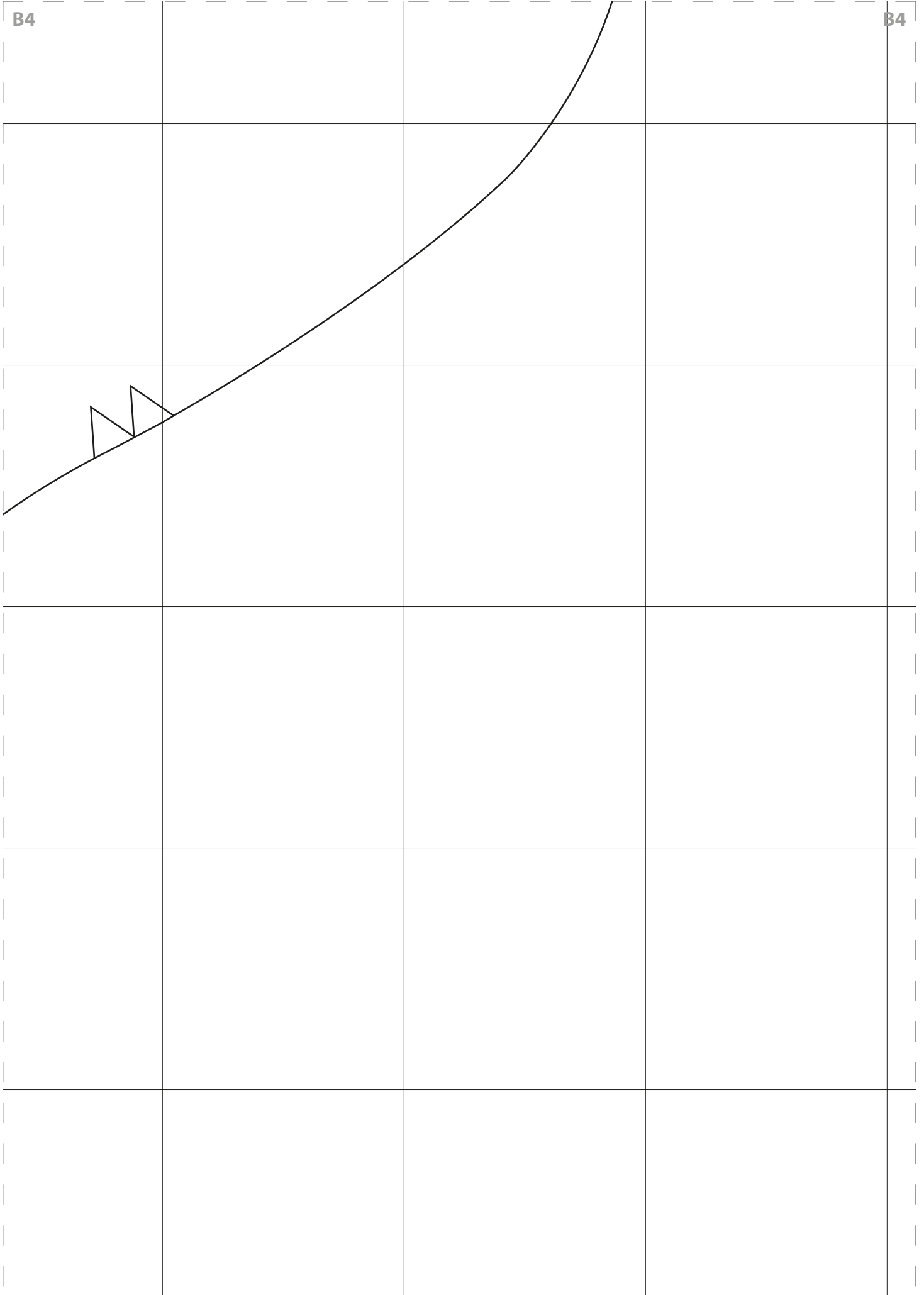

B5

B5

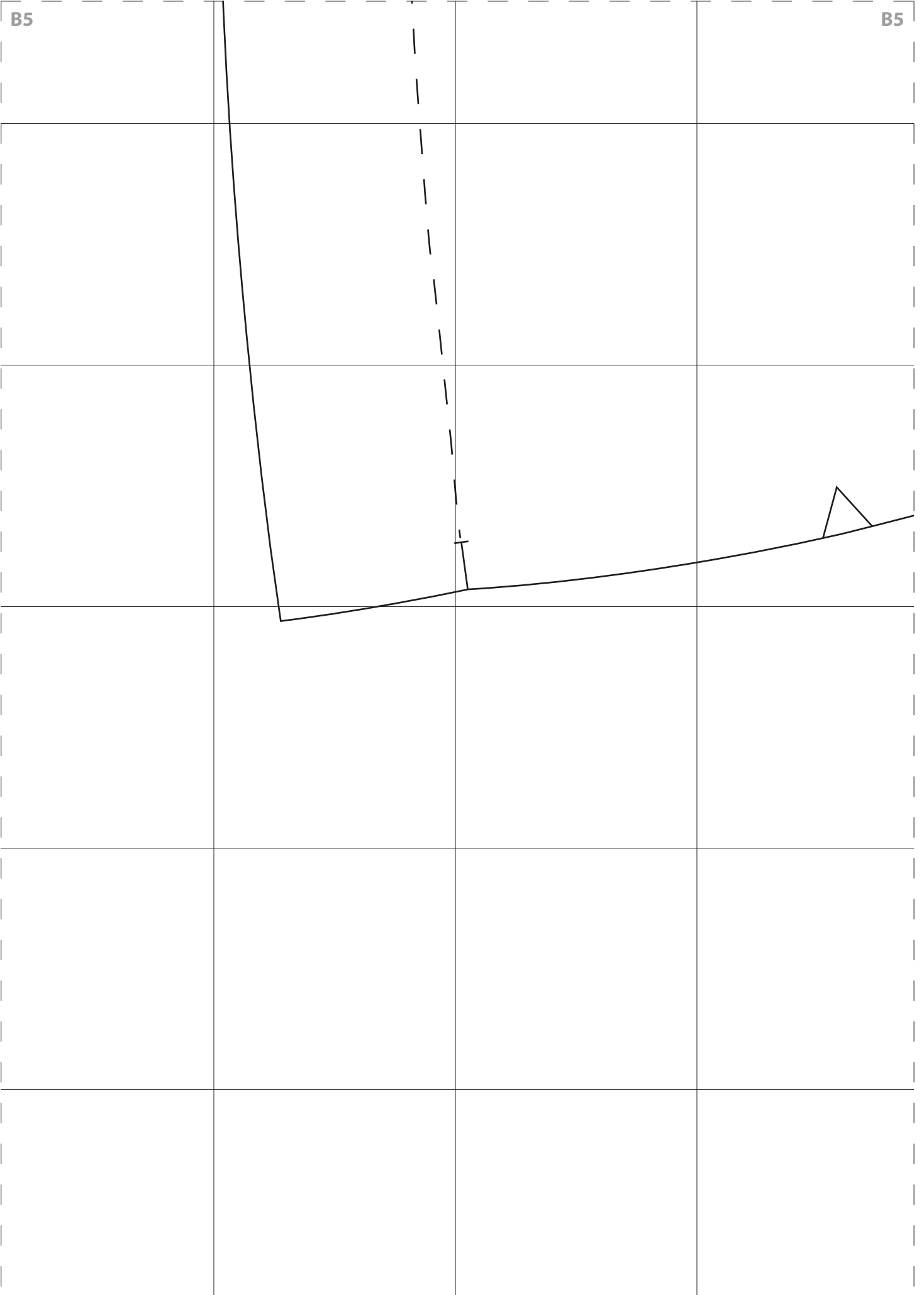

B5

B5

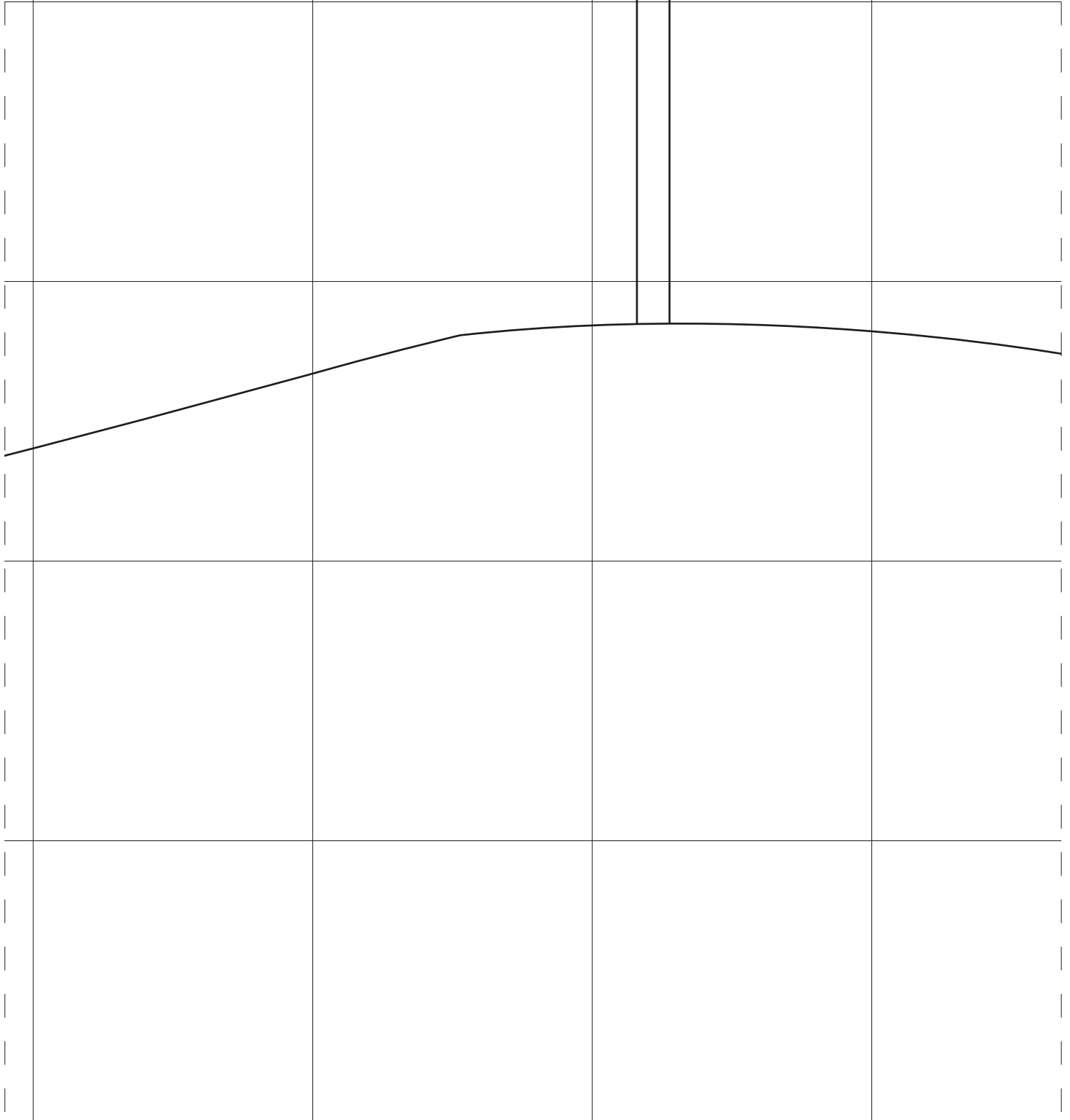

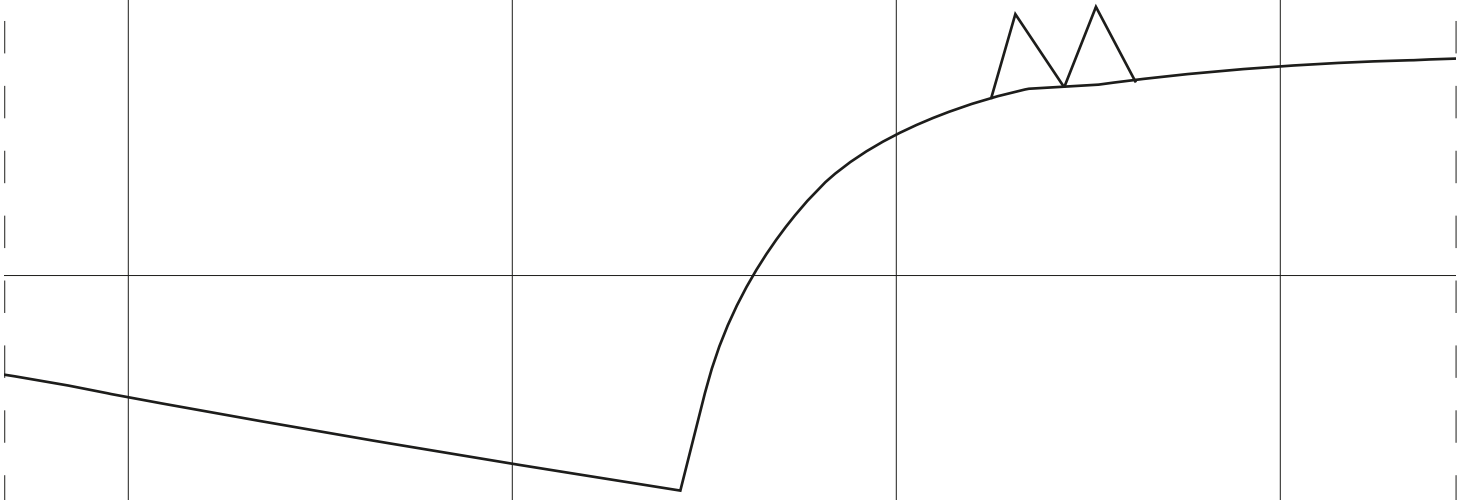

B8

B8

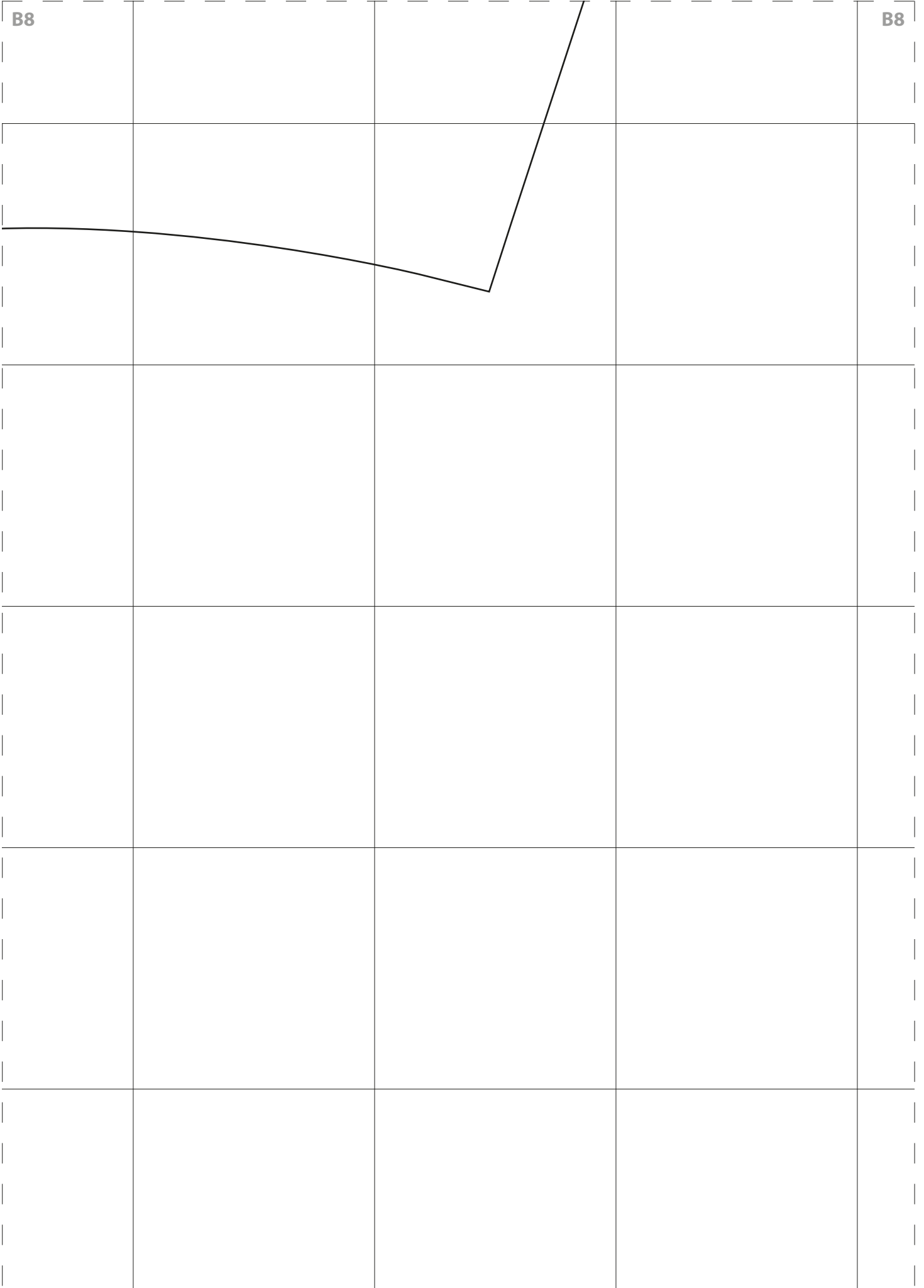

B8

B8

C1

C1

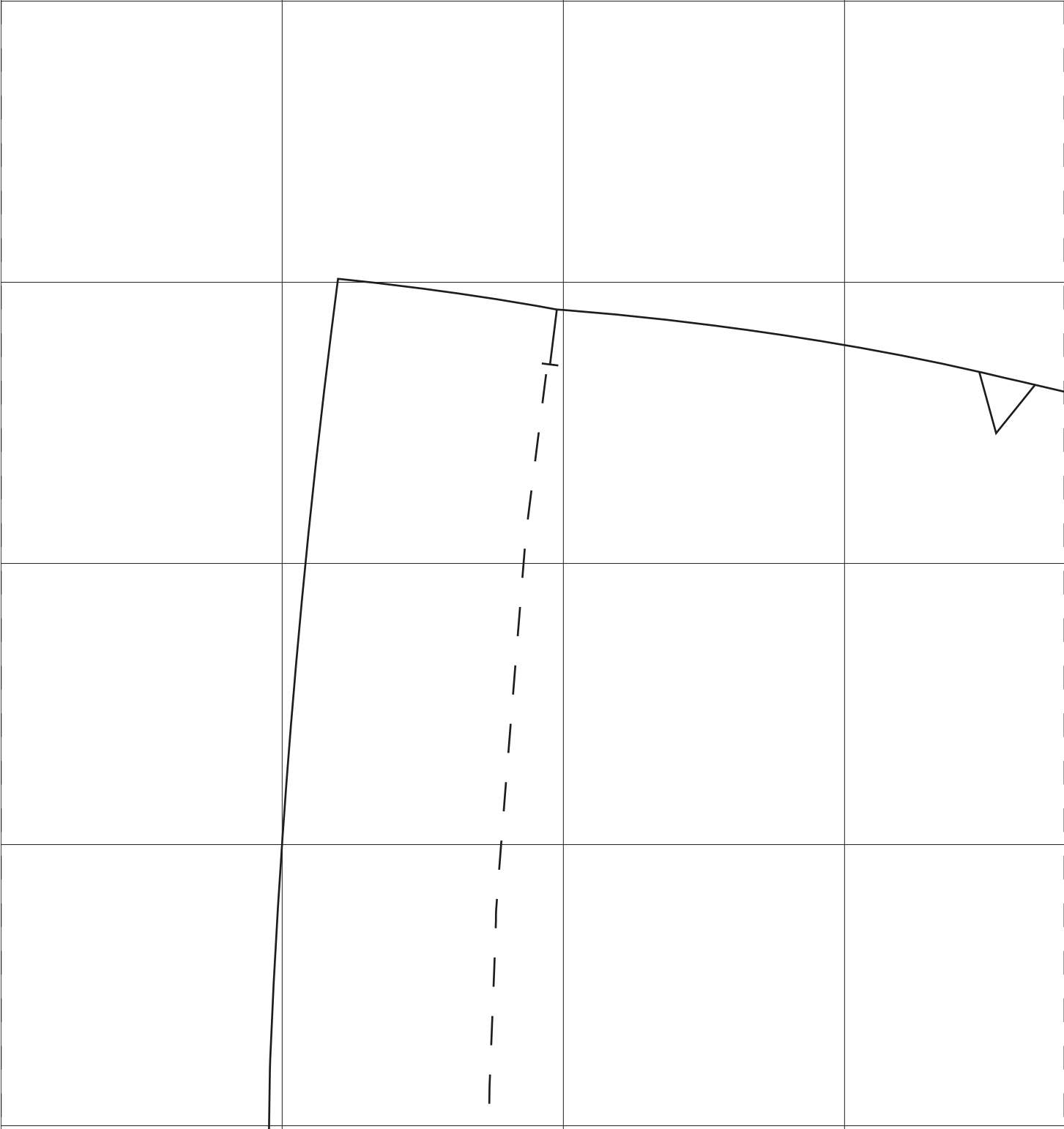

C1

C1

C2

C2

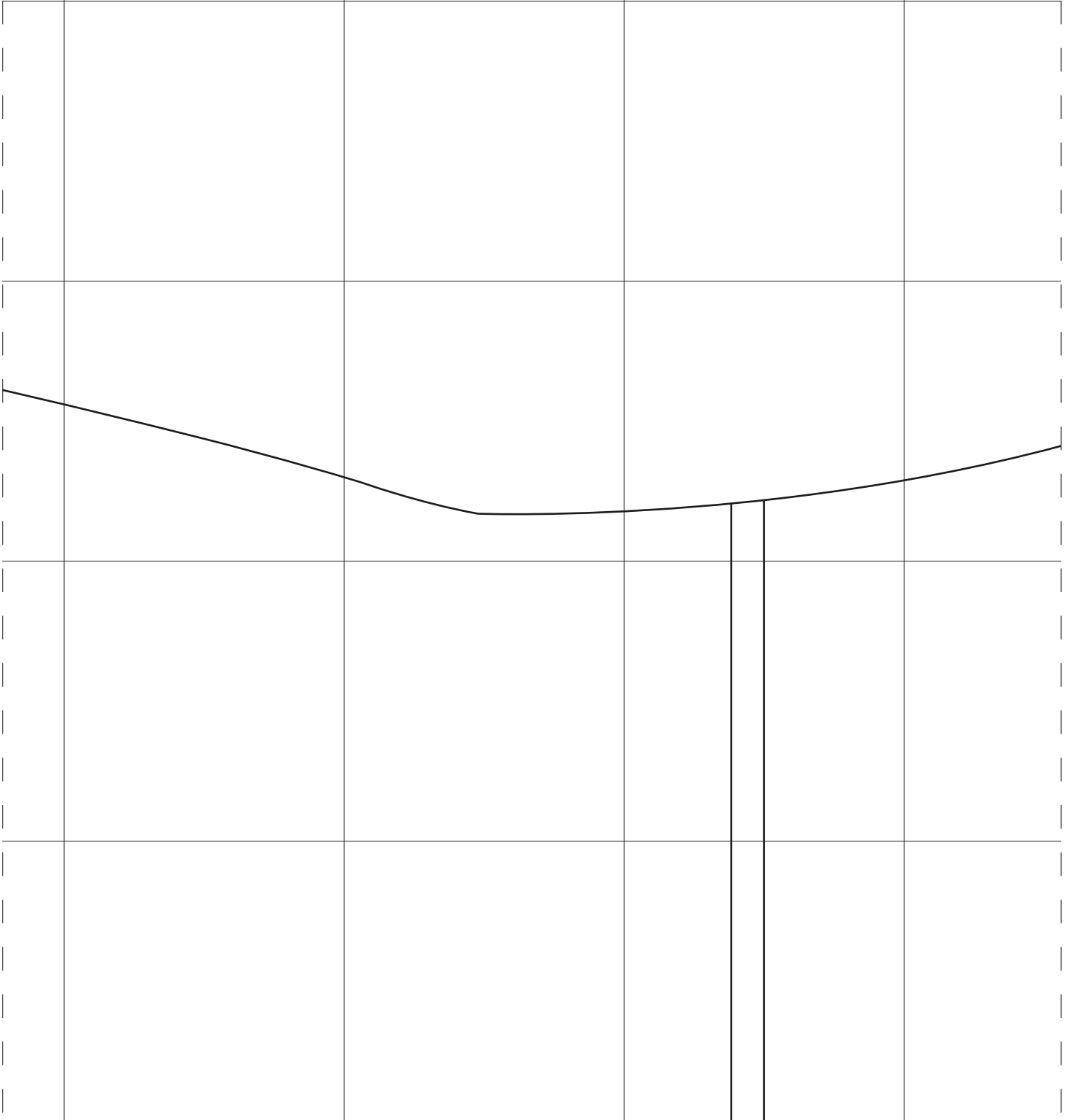

C2

C2

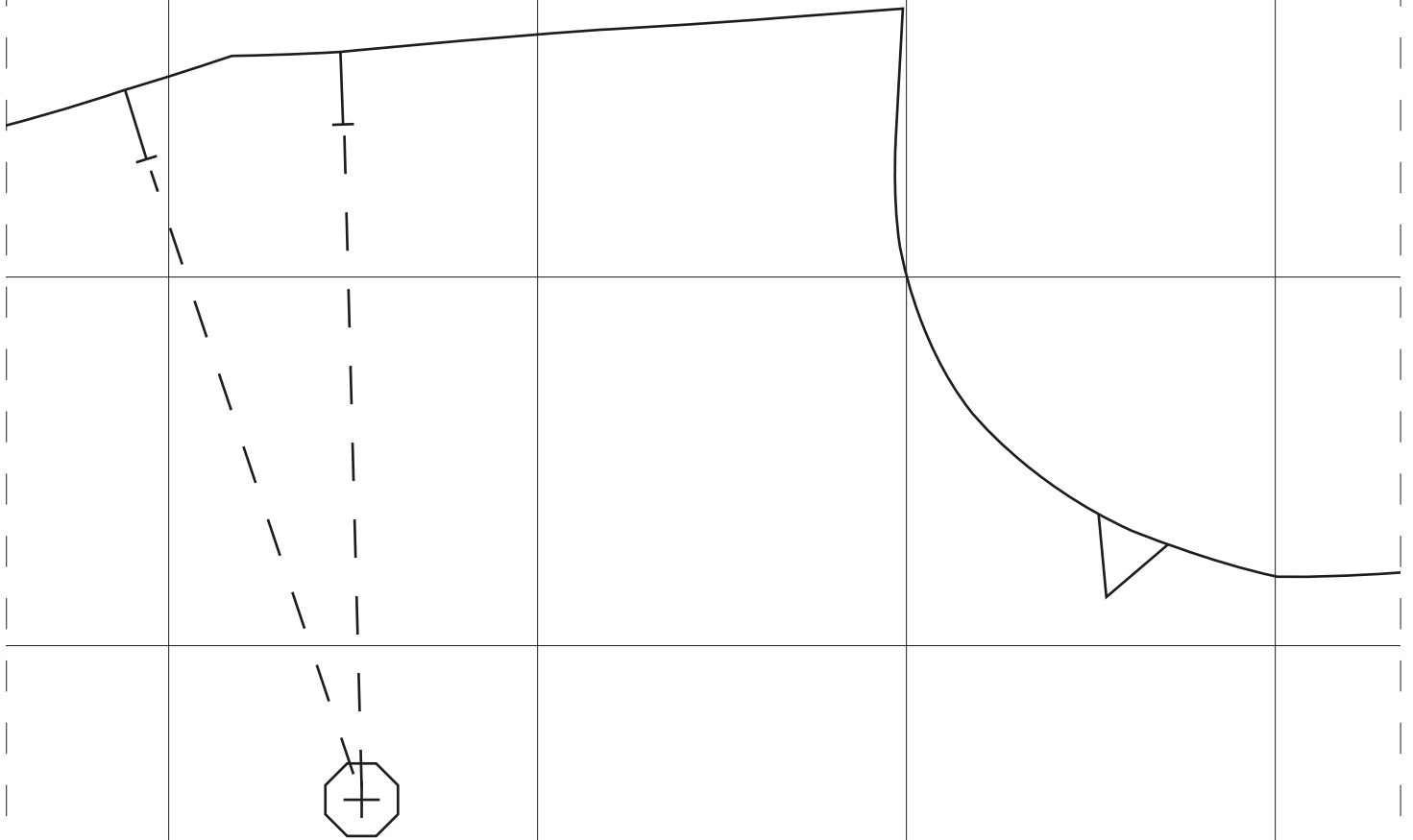

TOP FRONT
Cut 1 on folded fabric

C4

C4

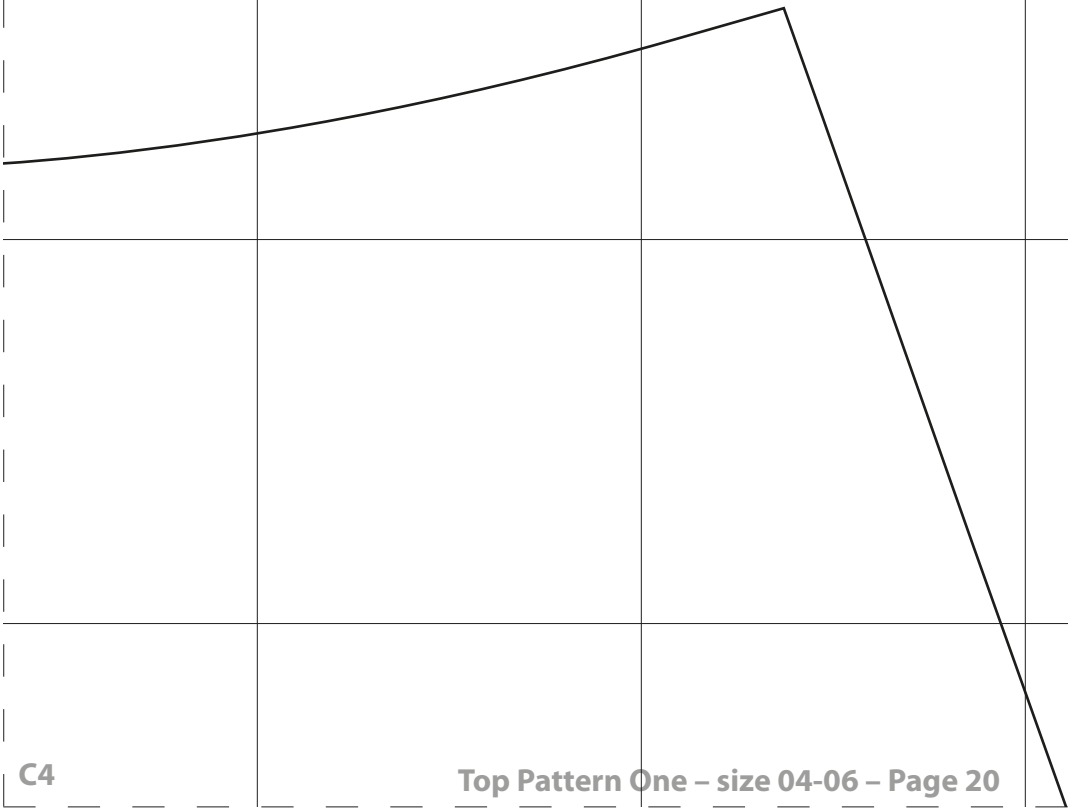

C4

C4

CB

BACK
FACING

Cut 2 fabric
Cut 2 interfacing



D1

D1

D1

D1

D2

D2

D2

D2

D3

D3



D3

D3

D4

D4

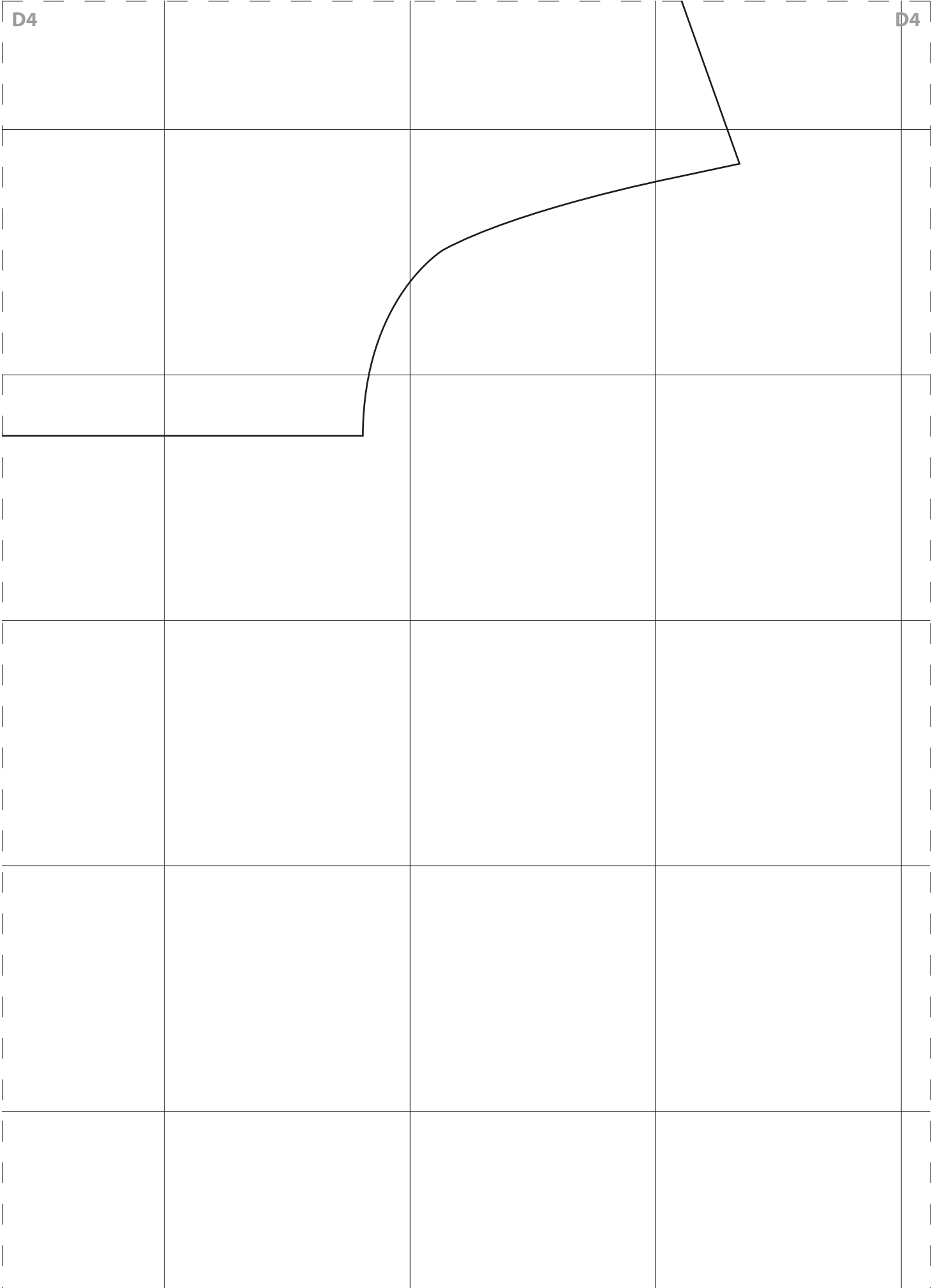

D4

D4

