

A1

A1

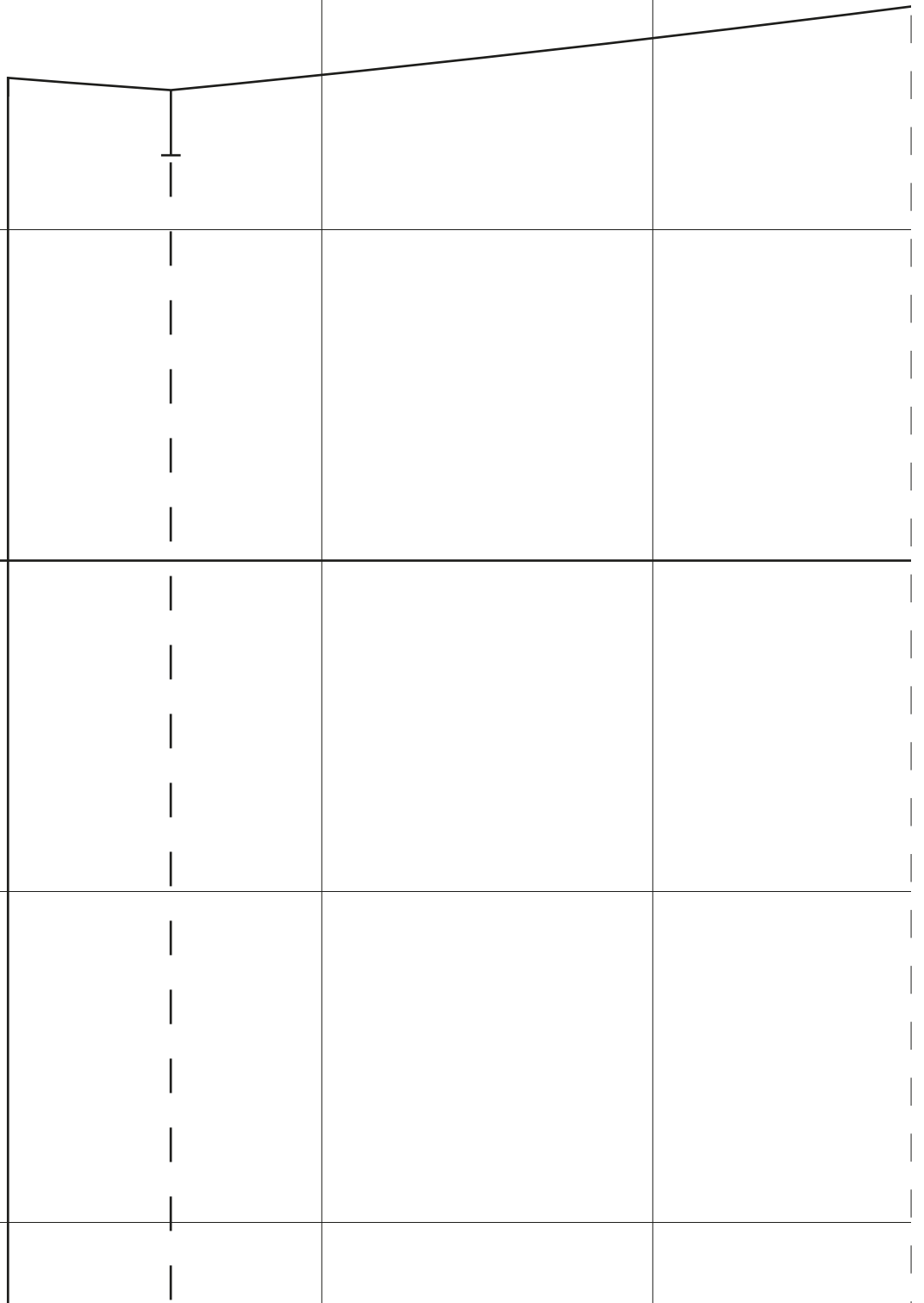

A1

A1

A2

A2

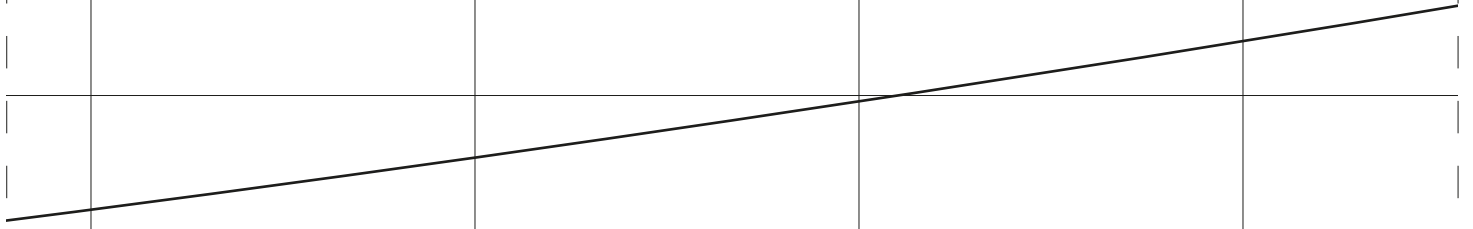

SLEEVE
Cut 2 fabric



A2

A2

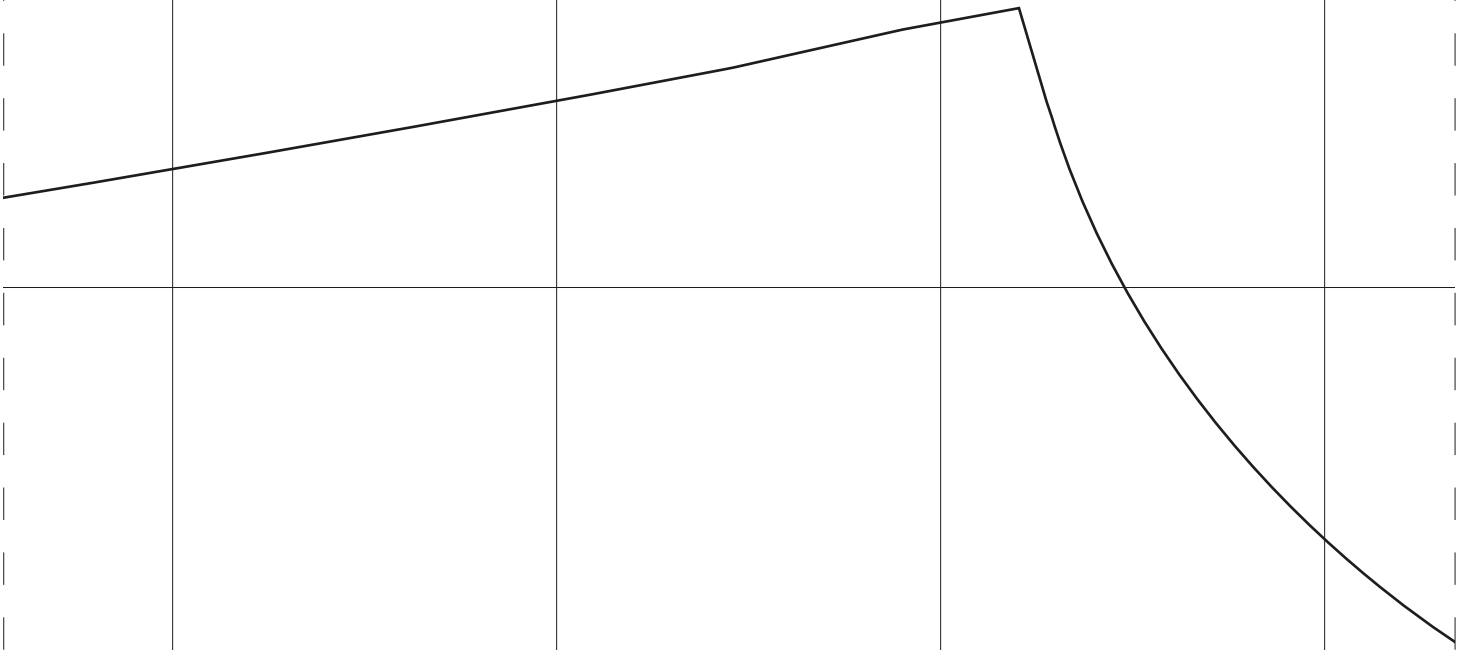

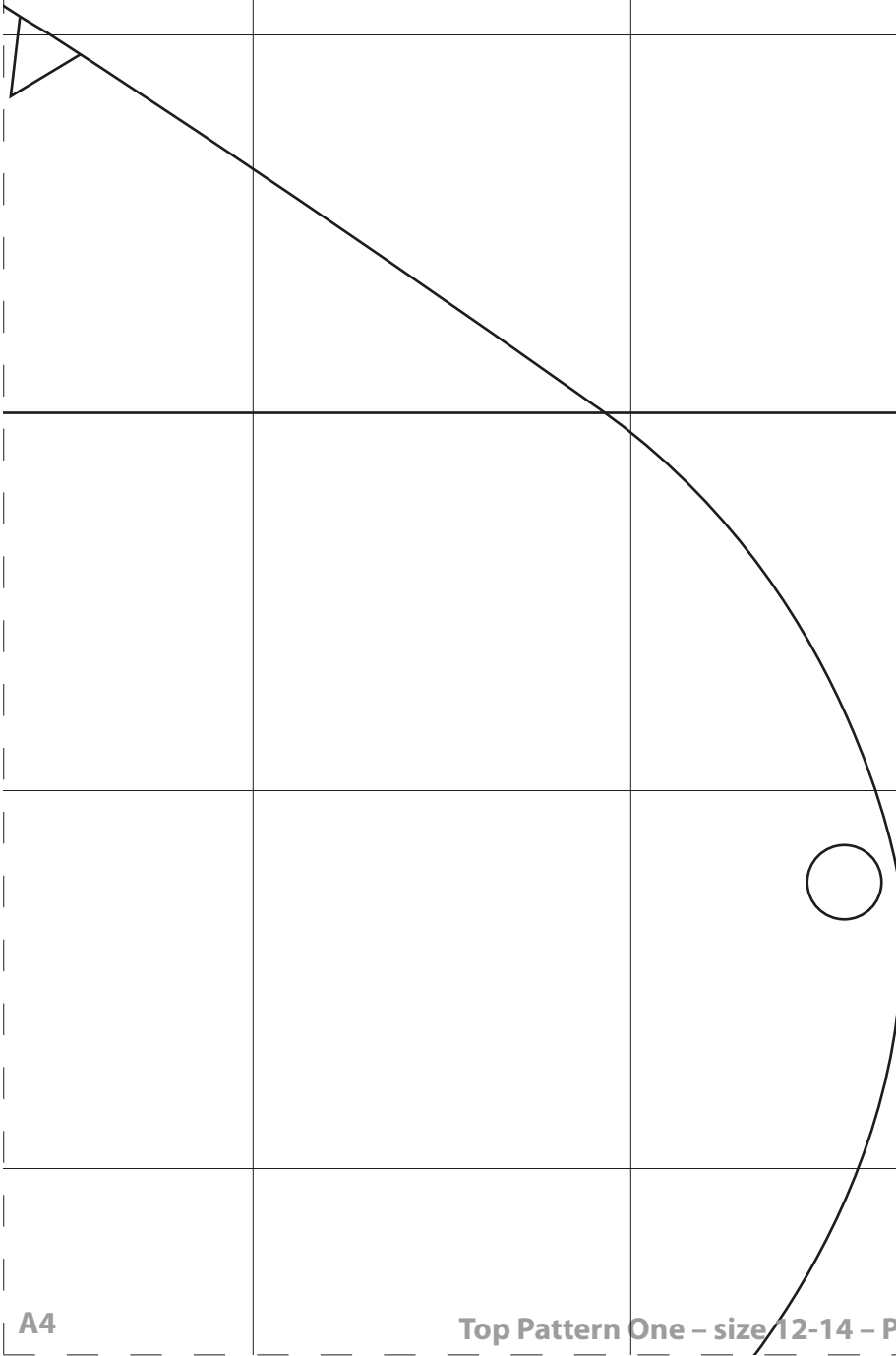

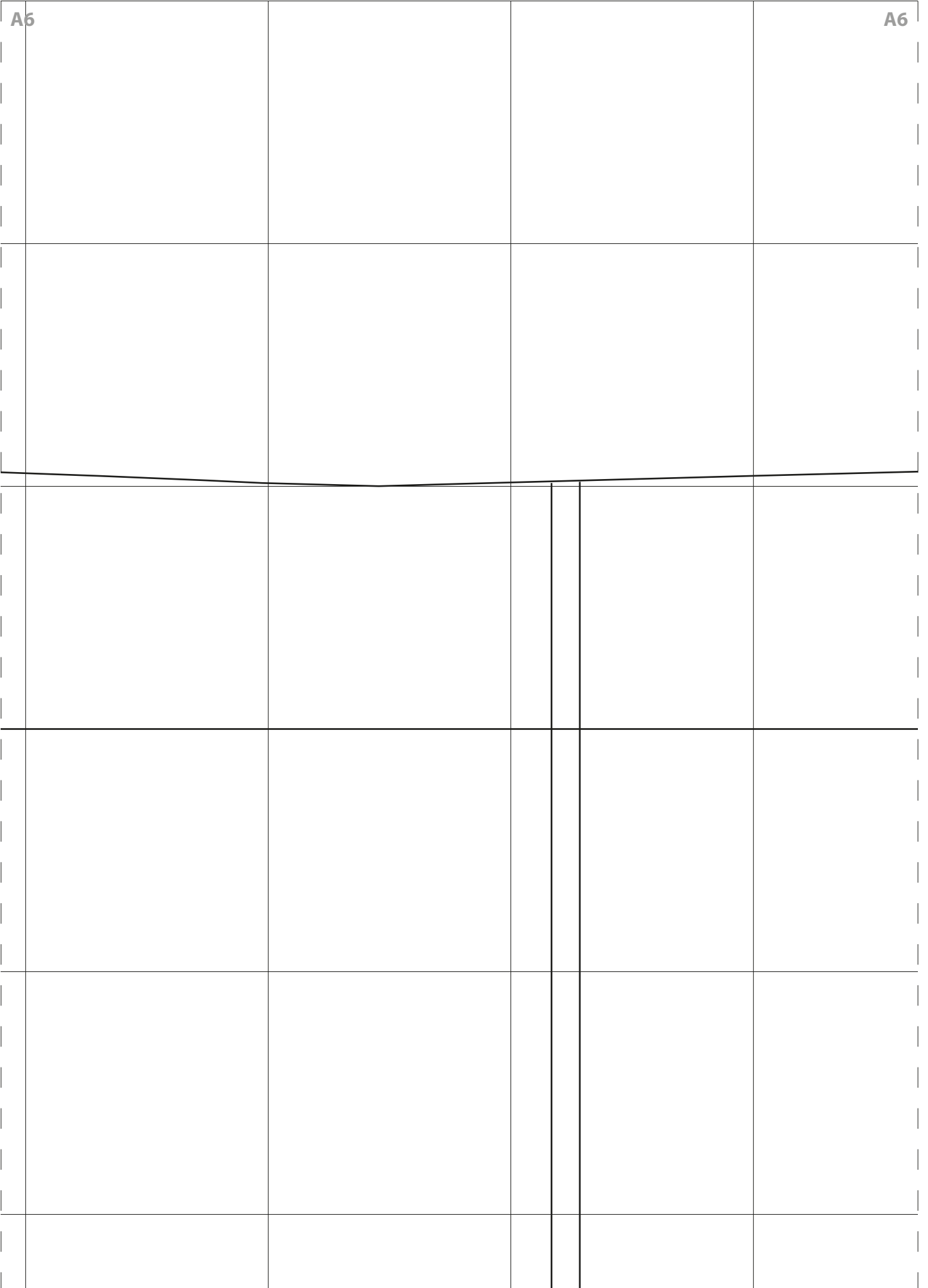

CB

TOP BACK
Cut 2 fabric



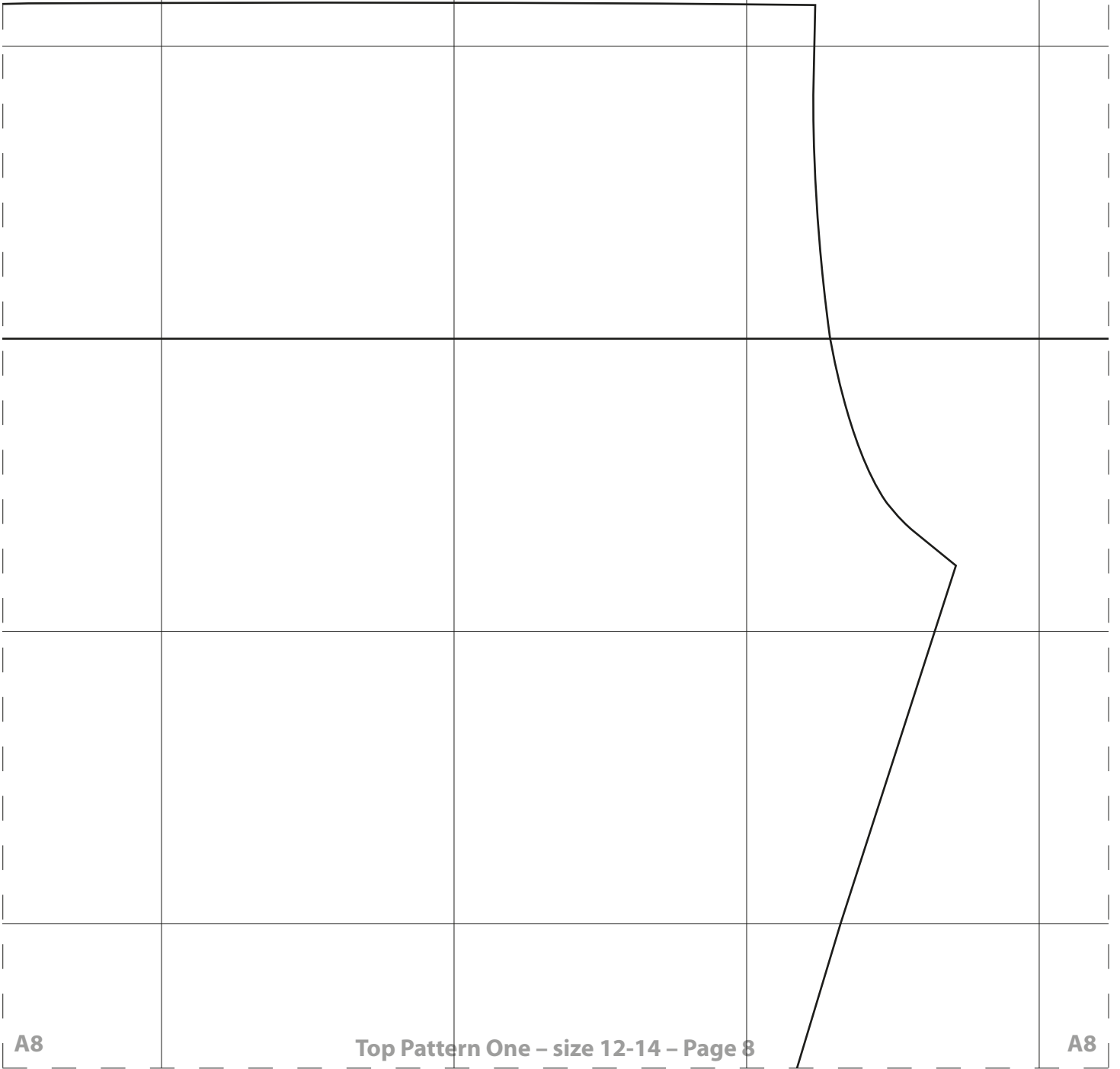

B1

B1

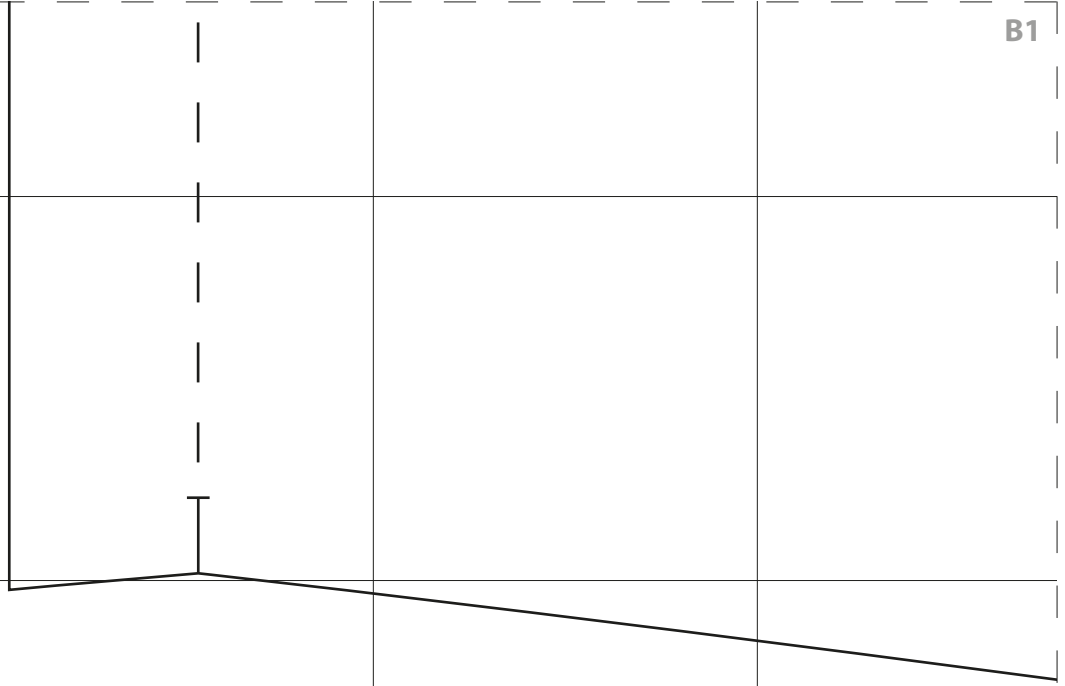

B1

B1

B2

B2

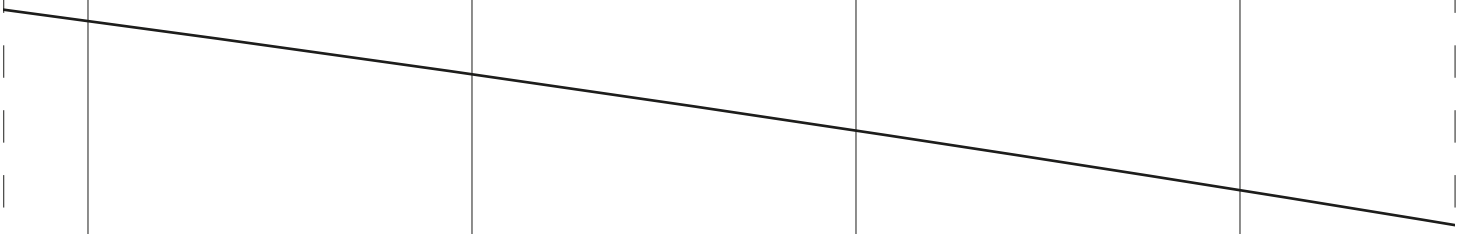

B2

B2

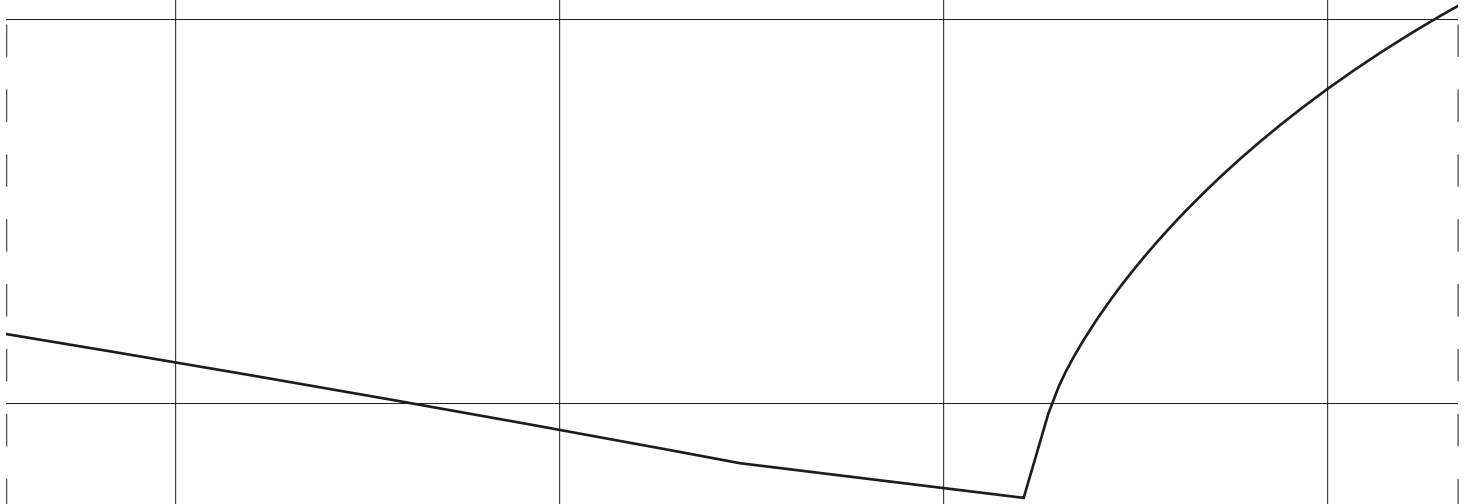

B4

B4

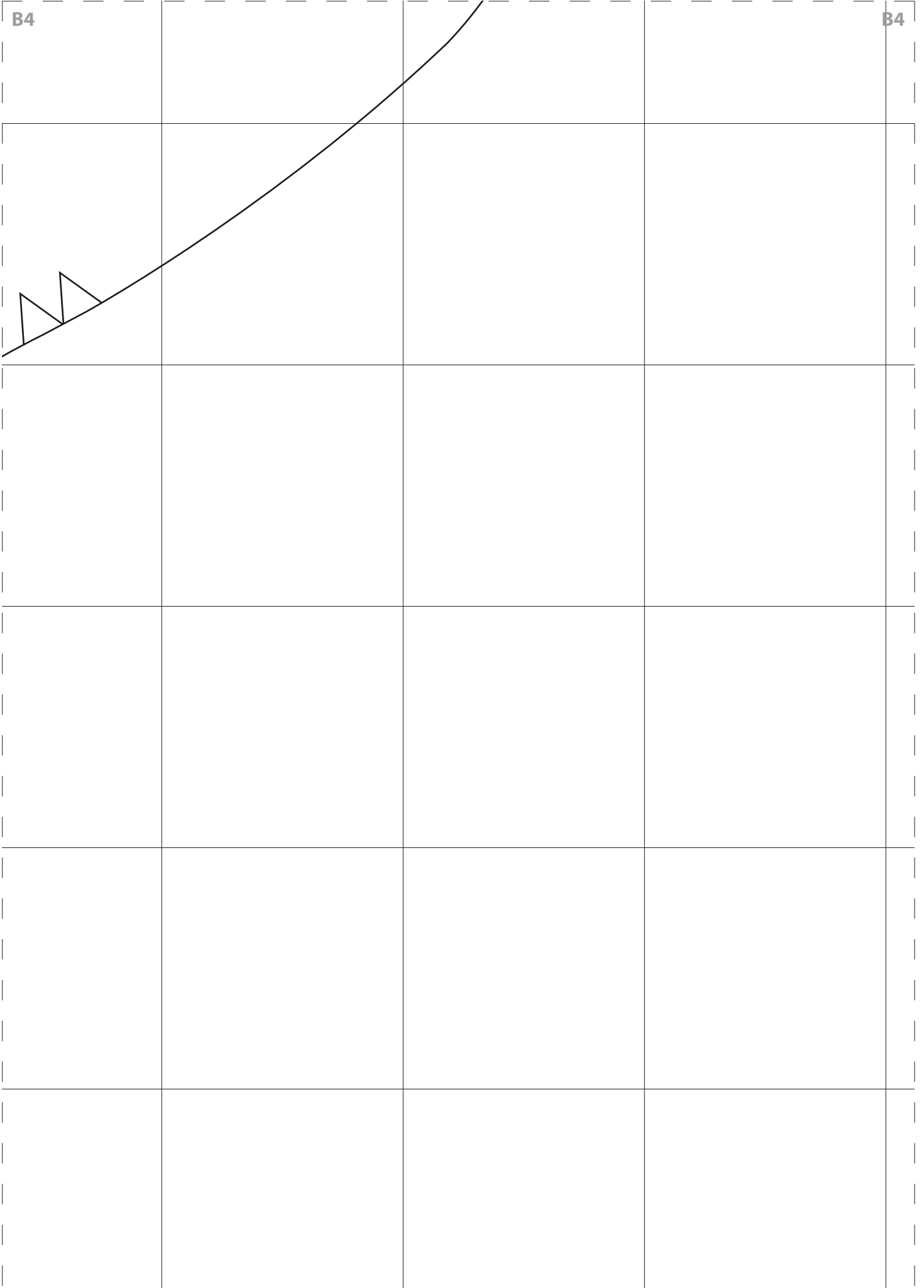

B4

B4

B5

B5

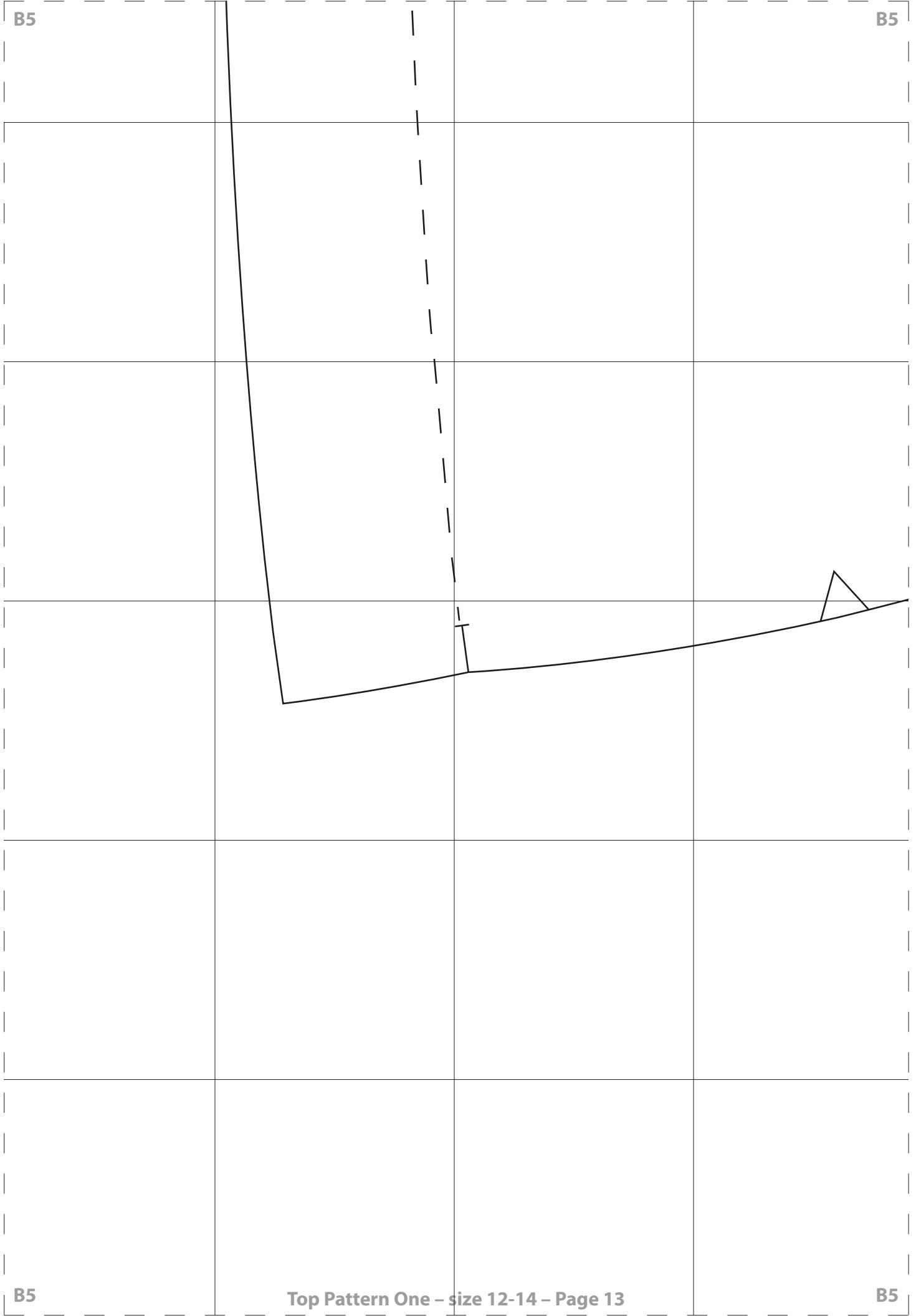

B5

B5

B6

B6

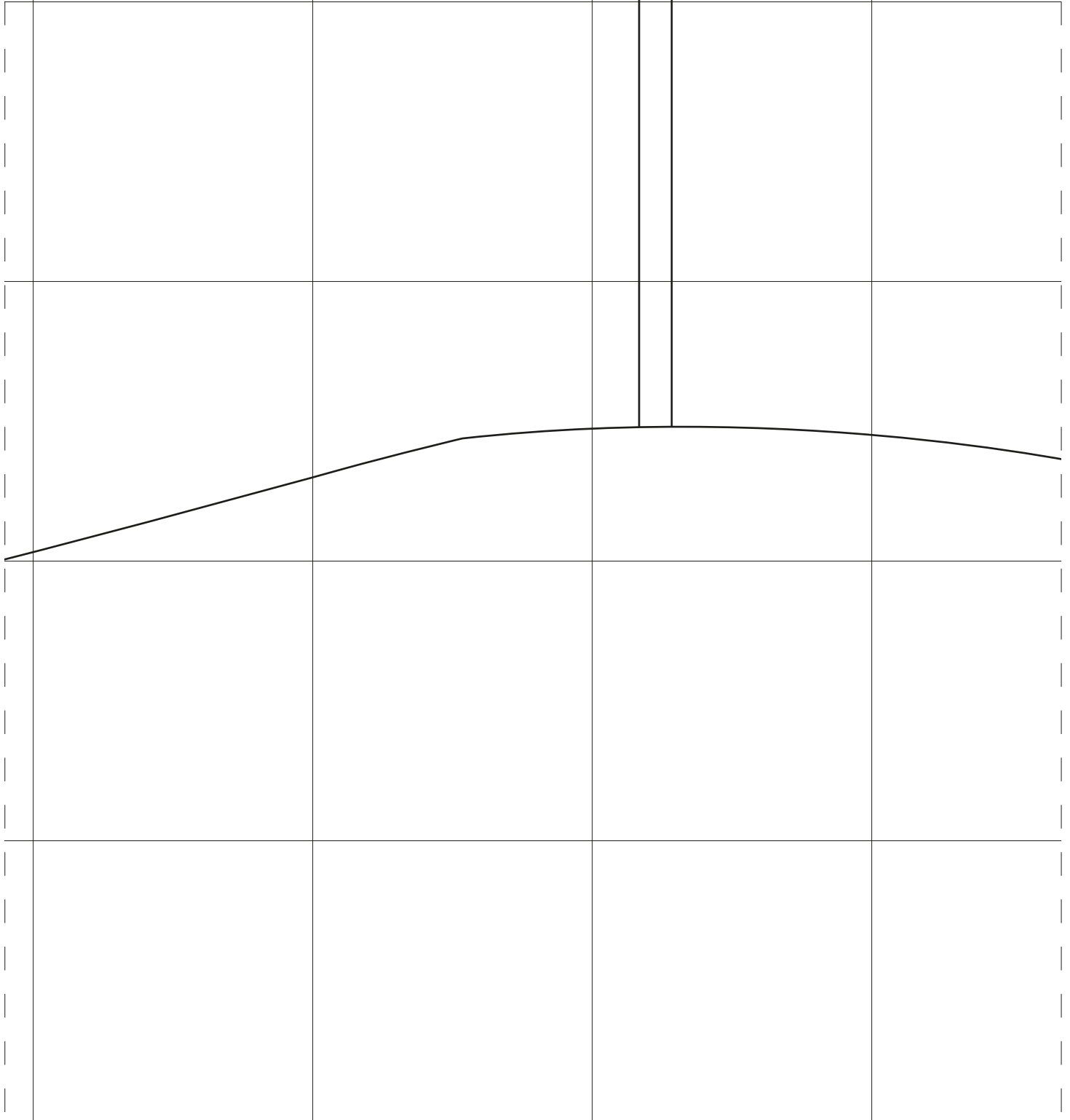

B6

B6

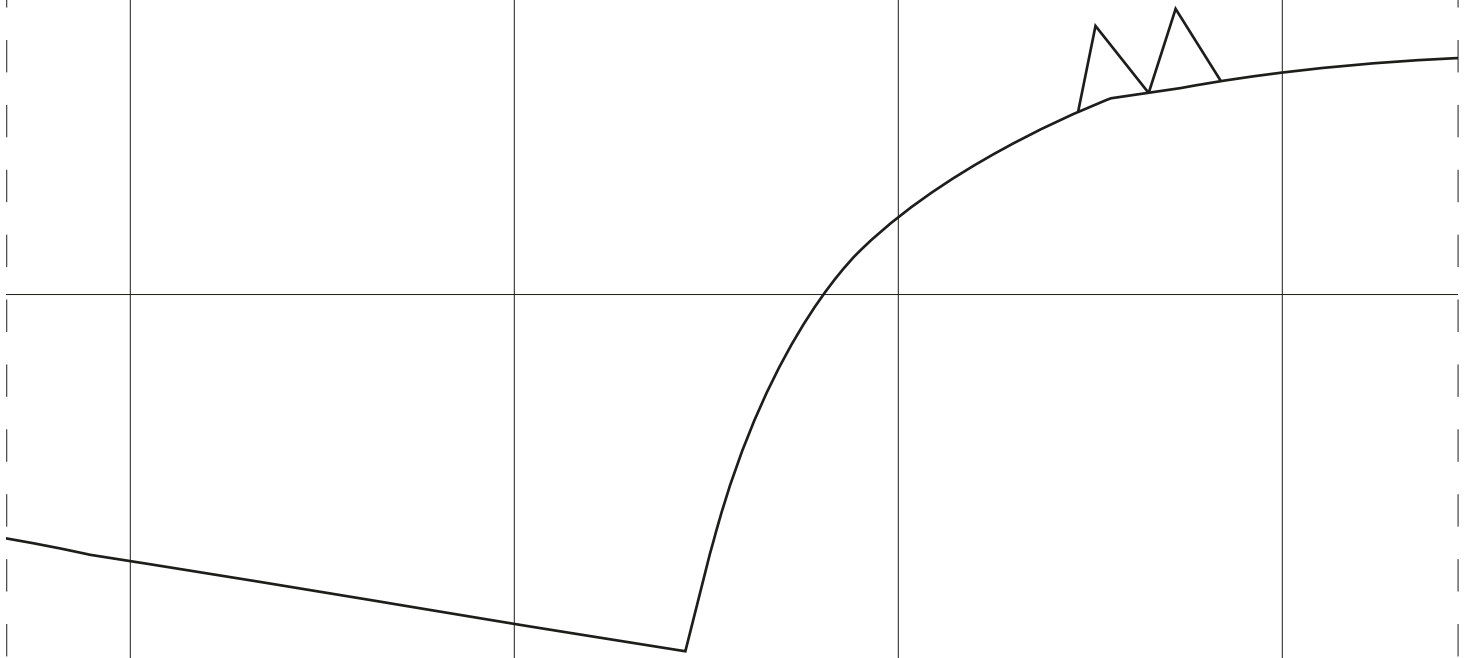

B8

B8

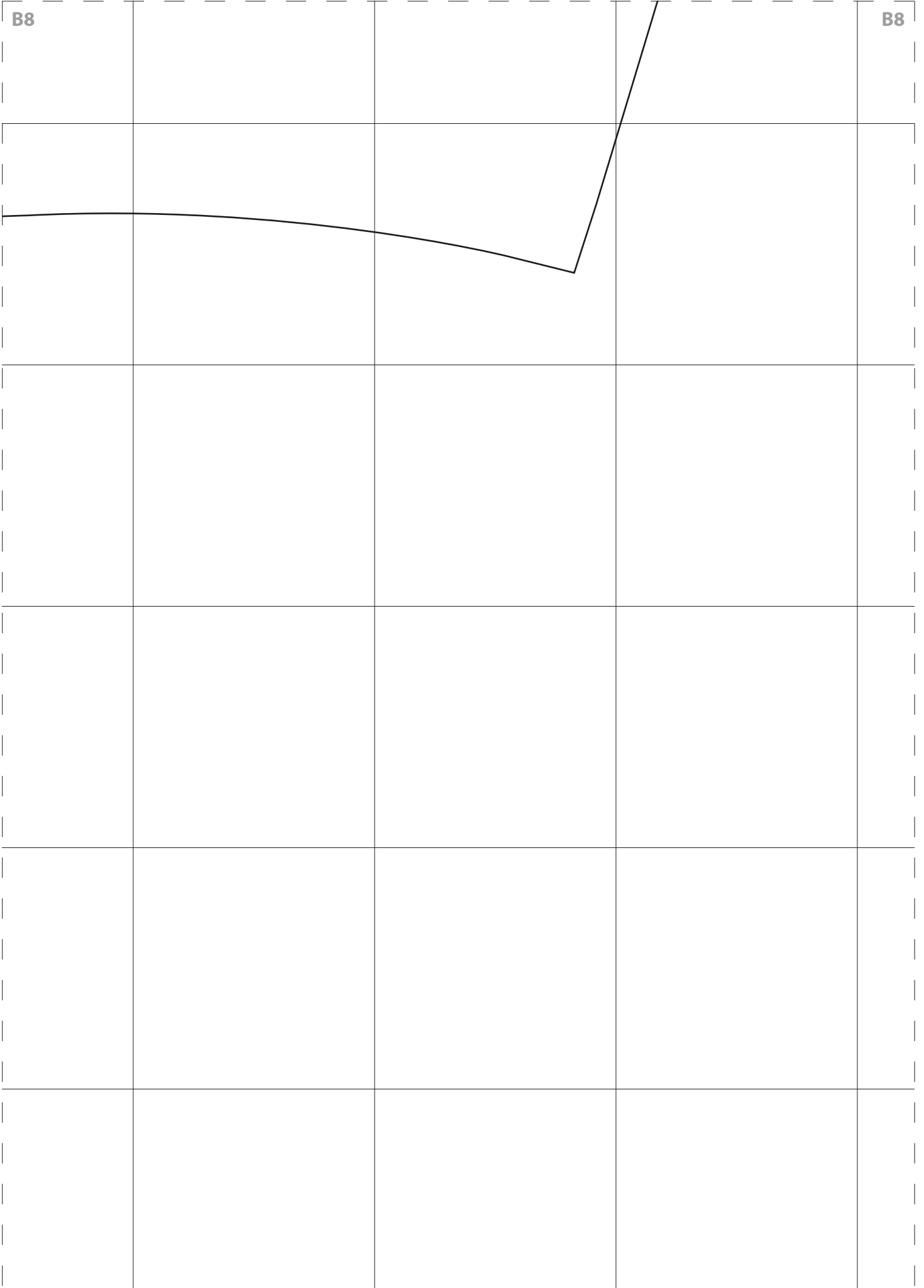

B8

B8

C1

C1

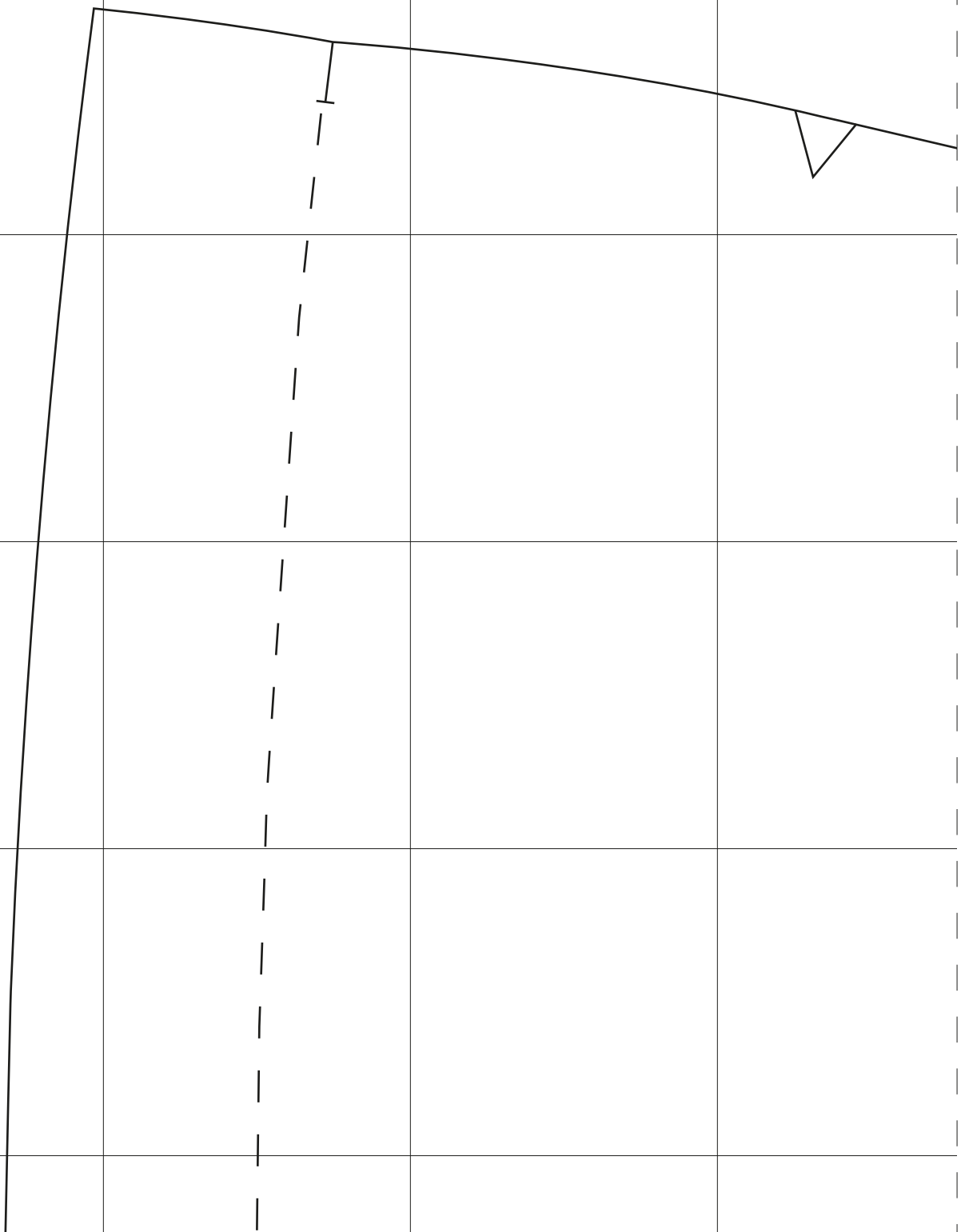

C1

C1

C2

C2

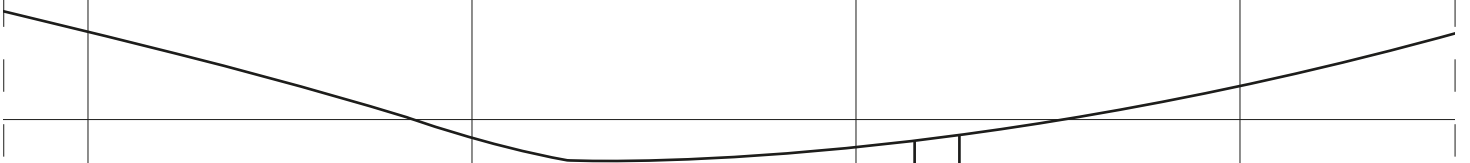

C2

C2

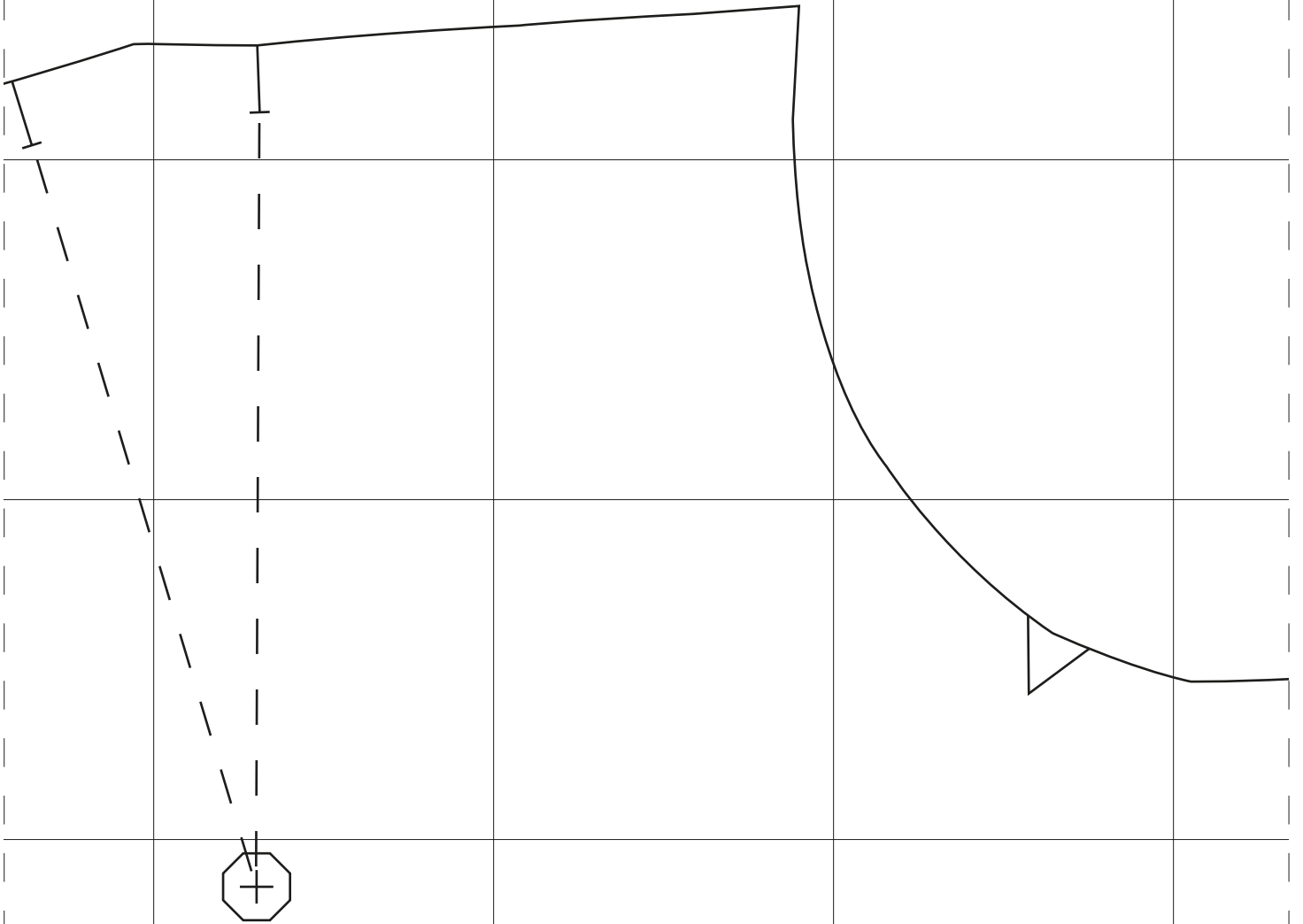

TOP FRONT
Cut 1 on folded fabric

C4

C4

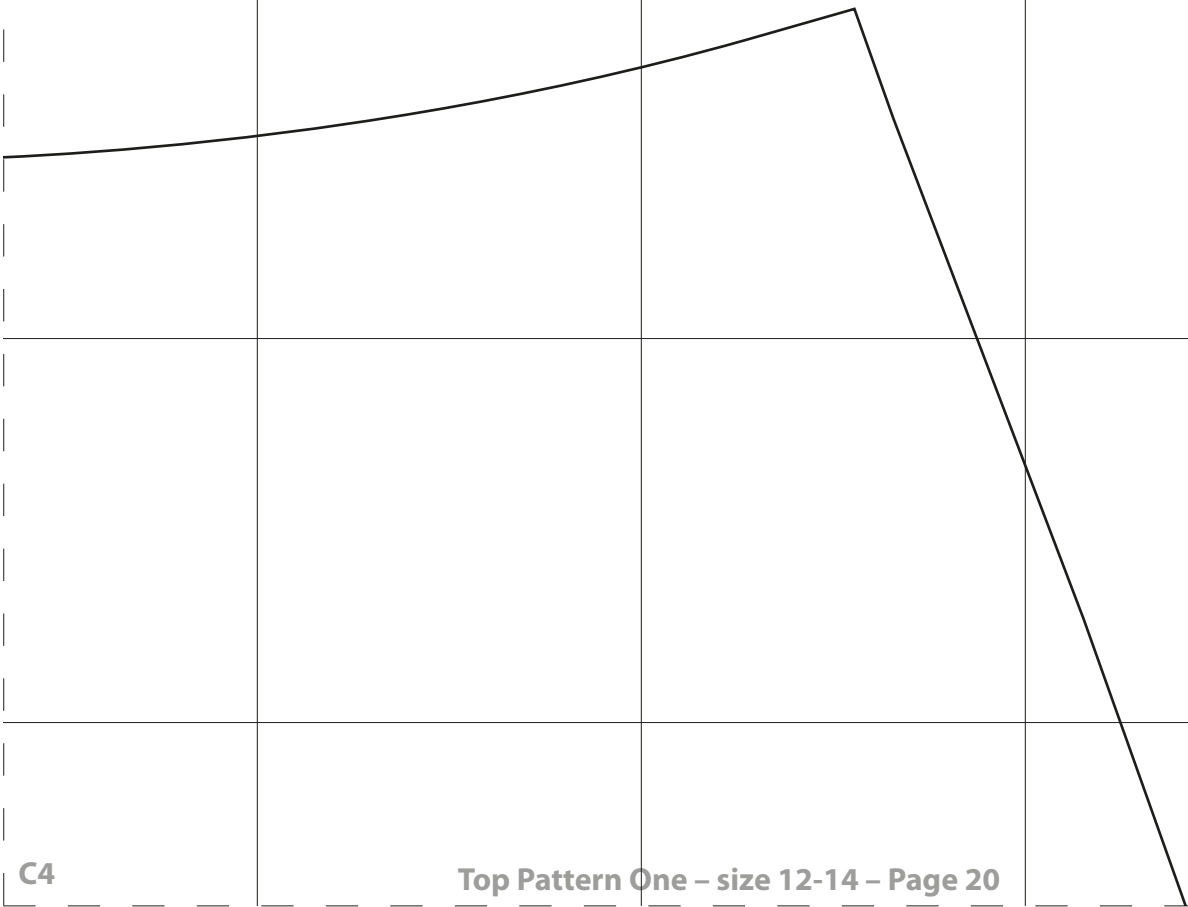

C4

C4

CB

BACK
FACING

Cut 2 fabric
Cut 2 interfacing



D1

D1



D1

D1

D2

D2

D2

D2

D3

D3



FOLD

D3

D3

D4

D4

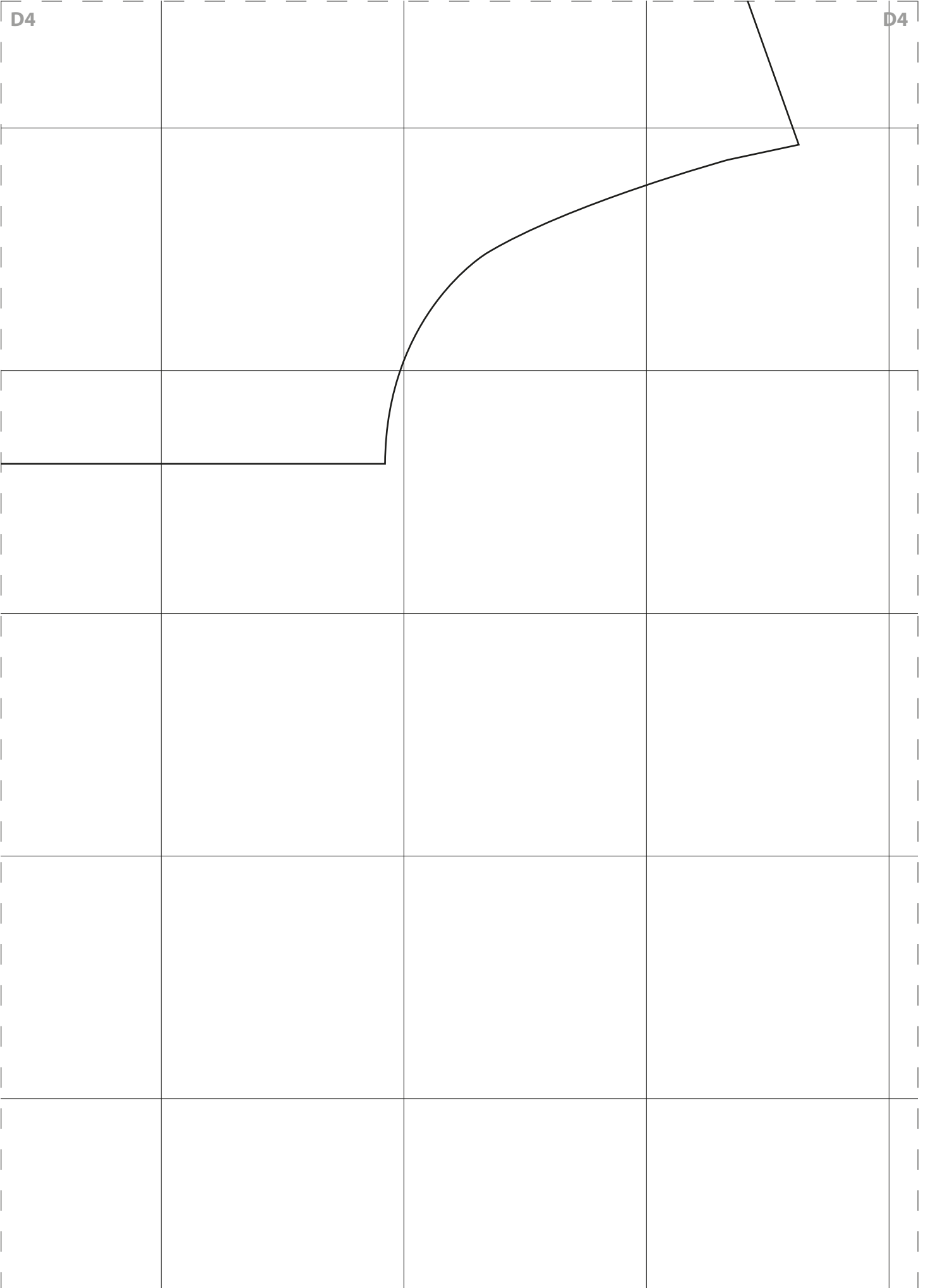

D4

D4

