

A1

A1

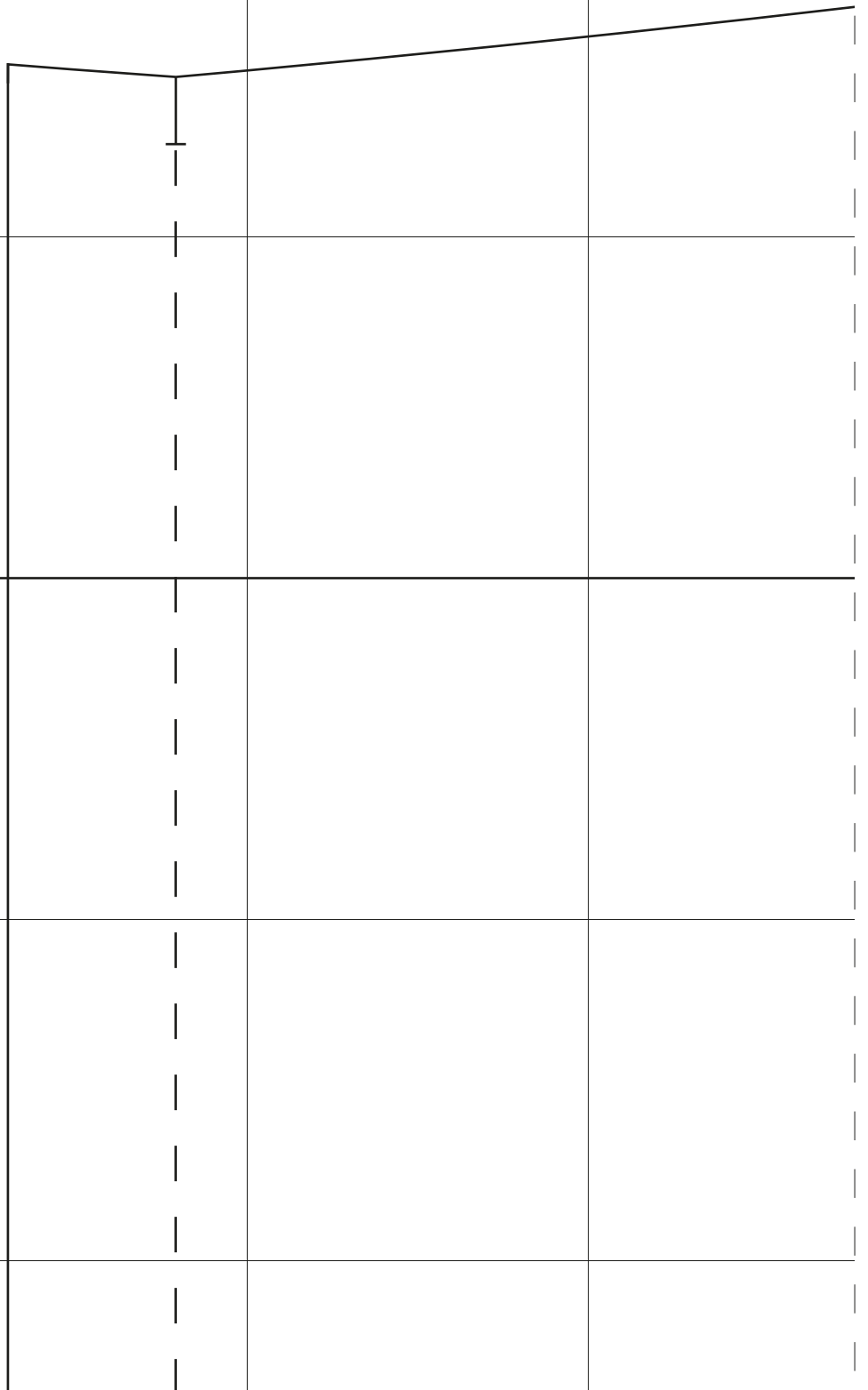

A1

A1

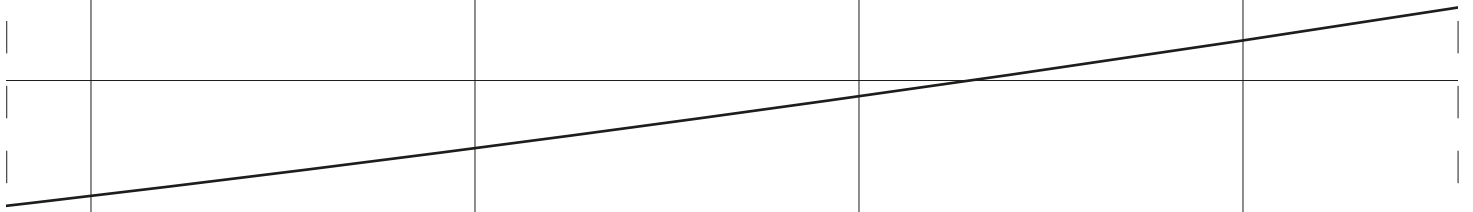

SLEEVE  
Cut 2 fabric



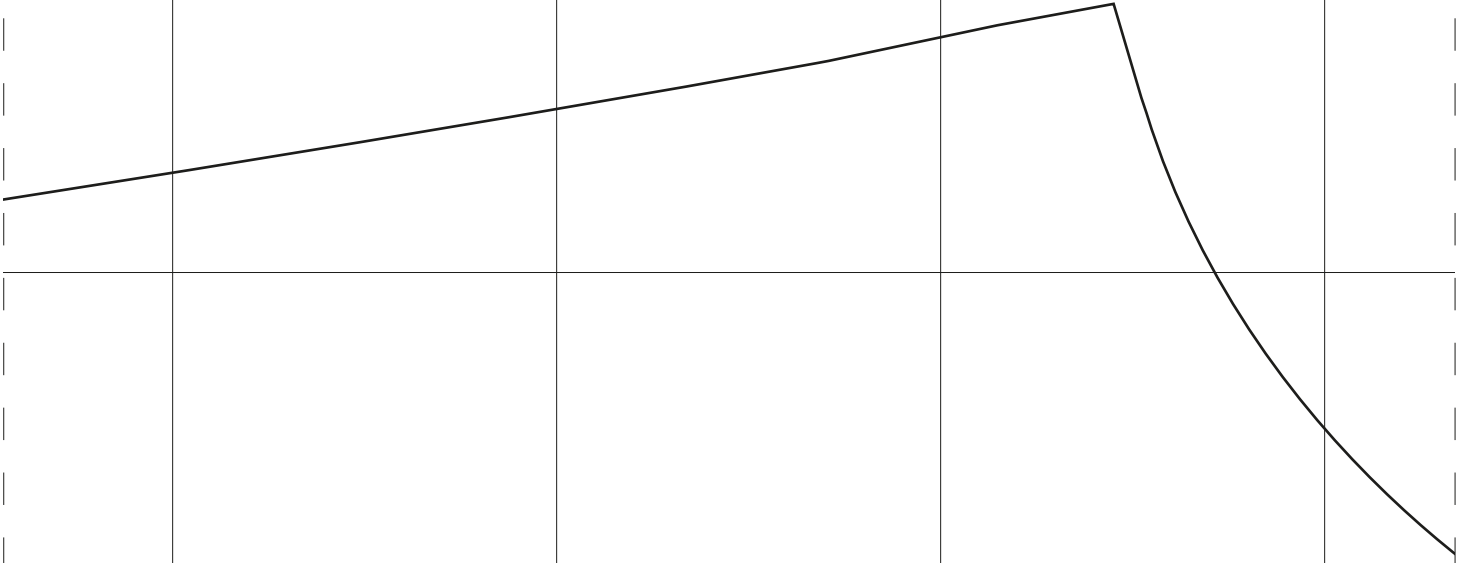

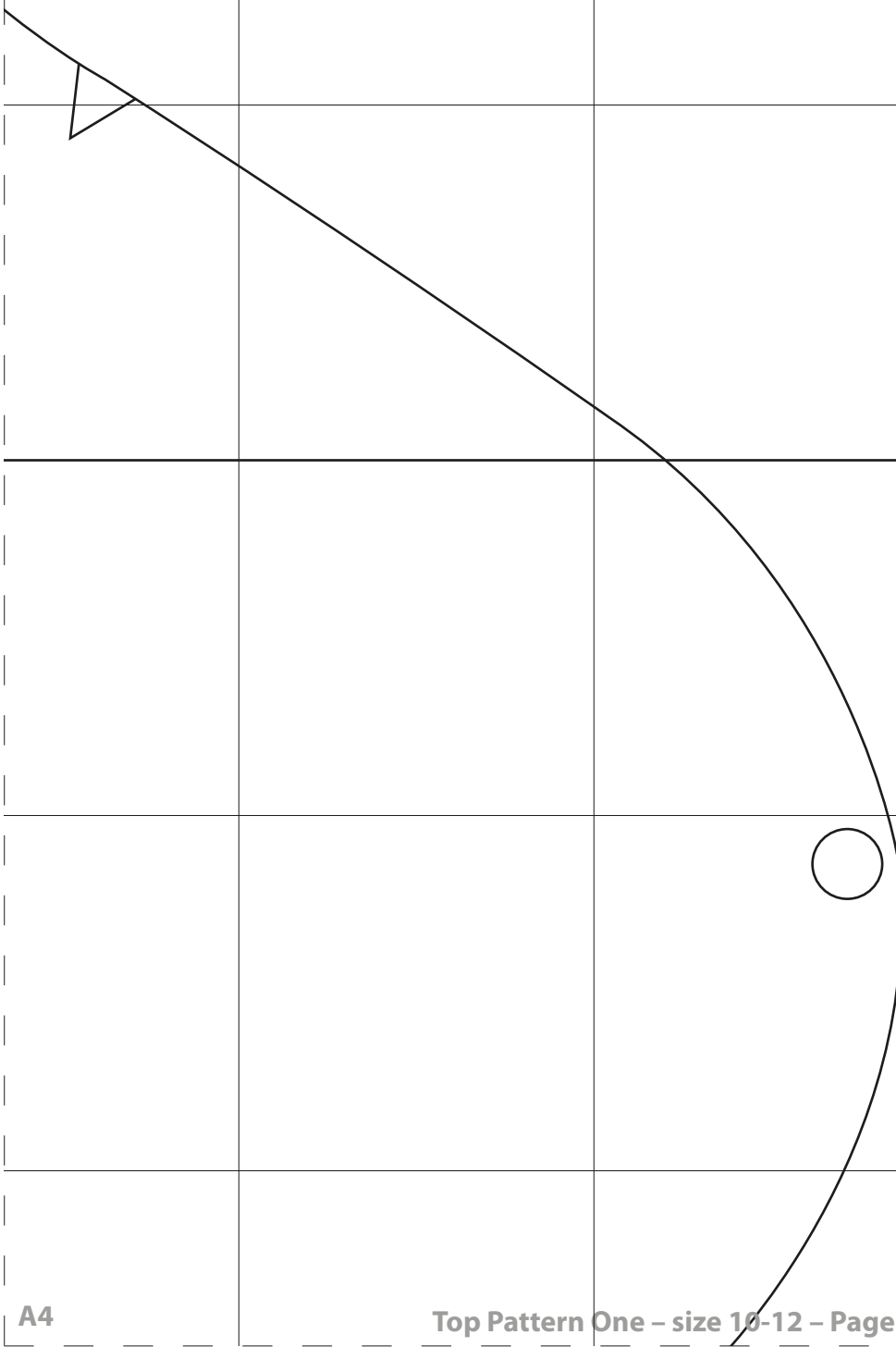

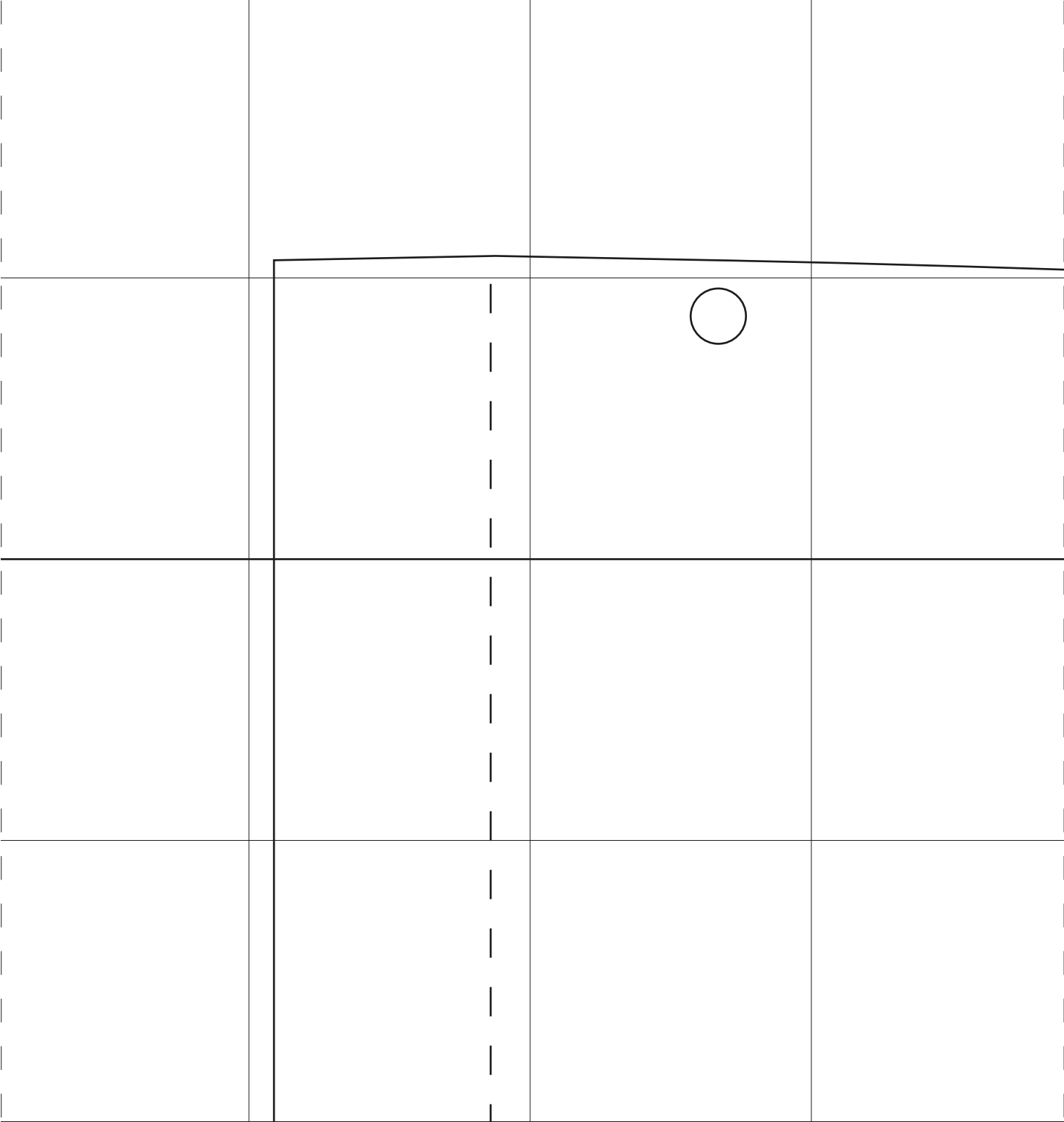

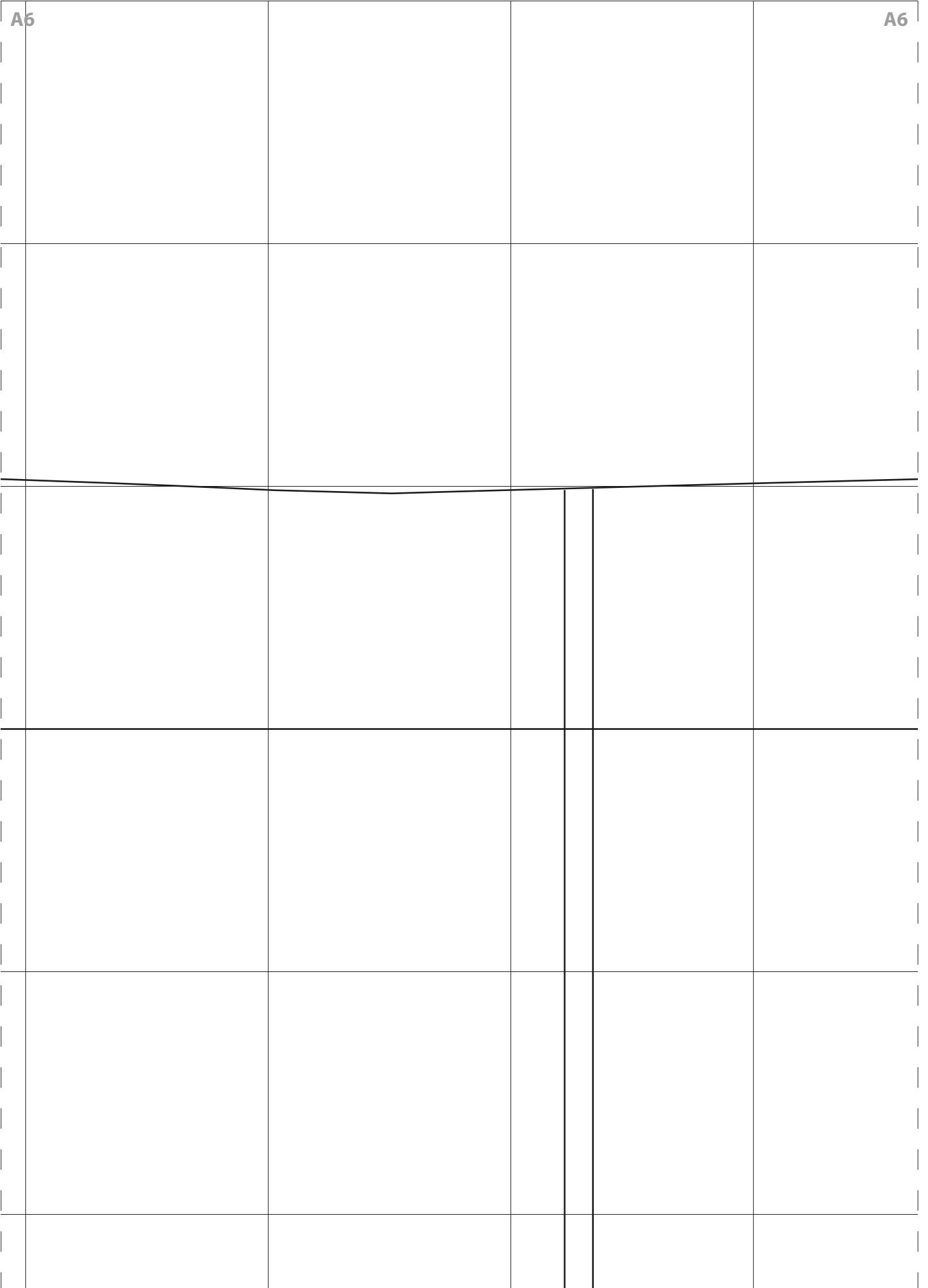

CB

TOP BACK  
Cut 2 fabric



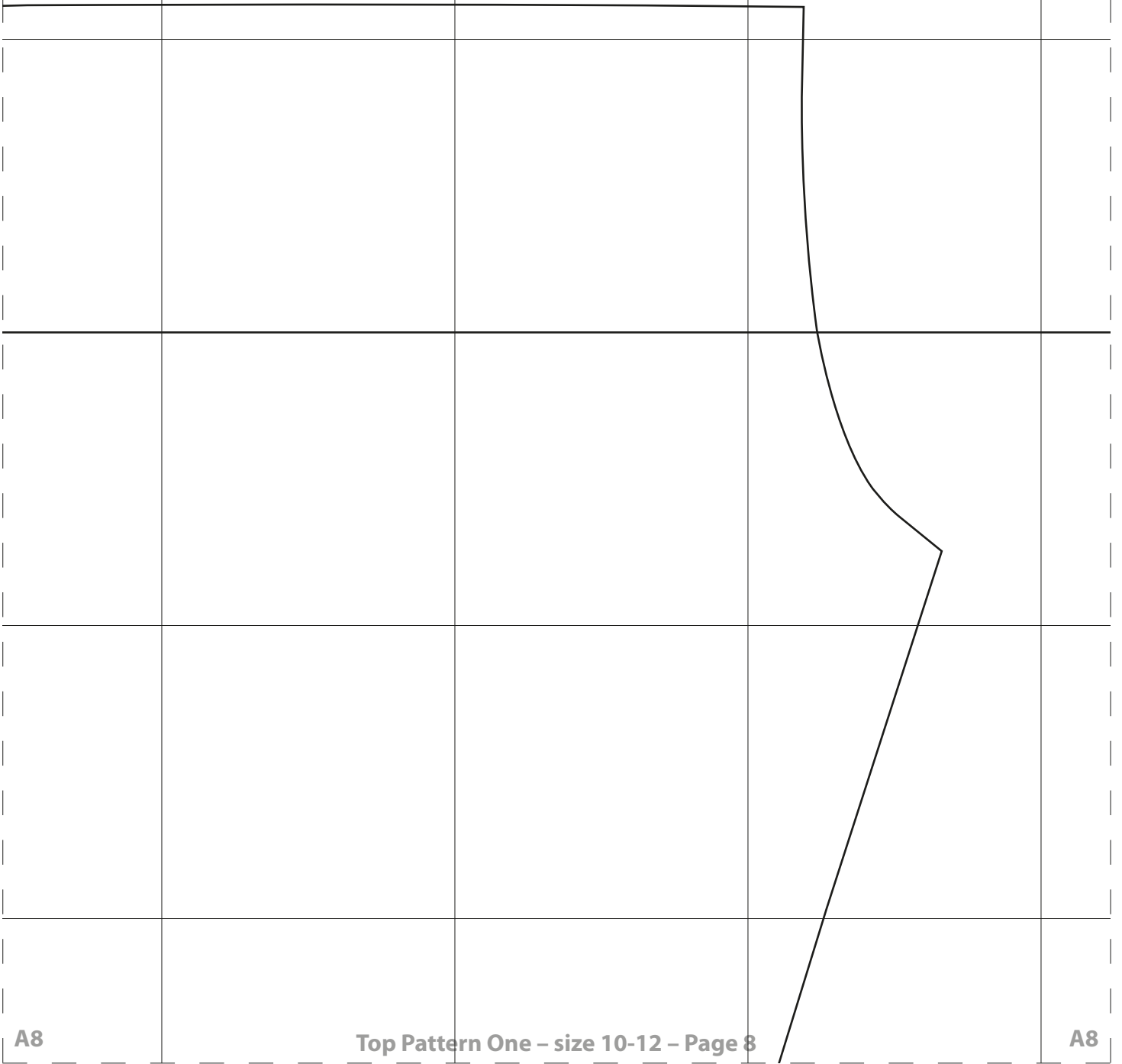



B1

B1

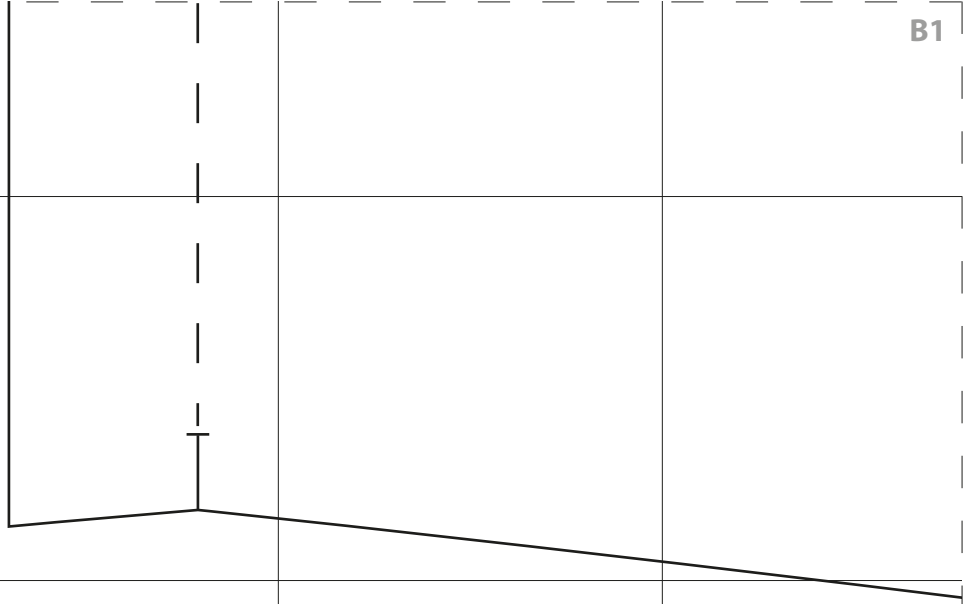

B1

B1

B2

B2

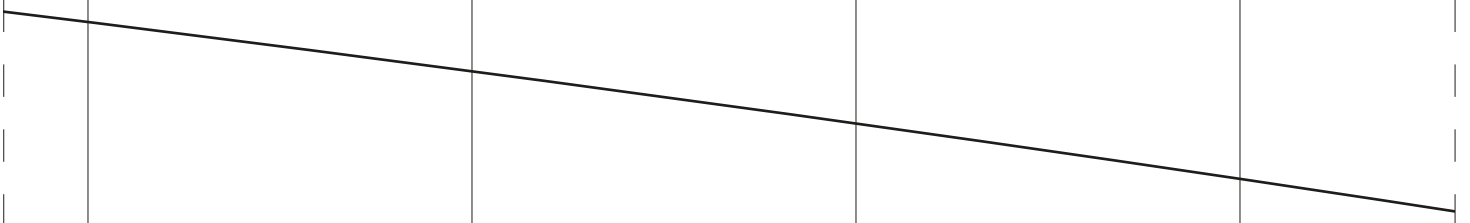

B2

B2

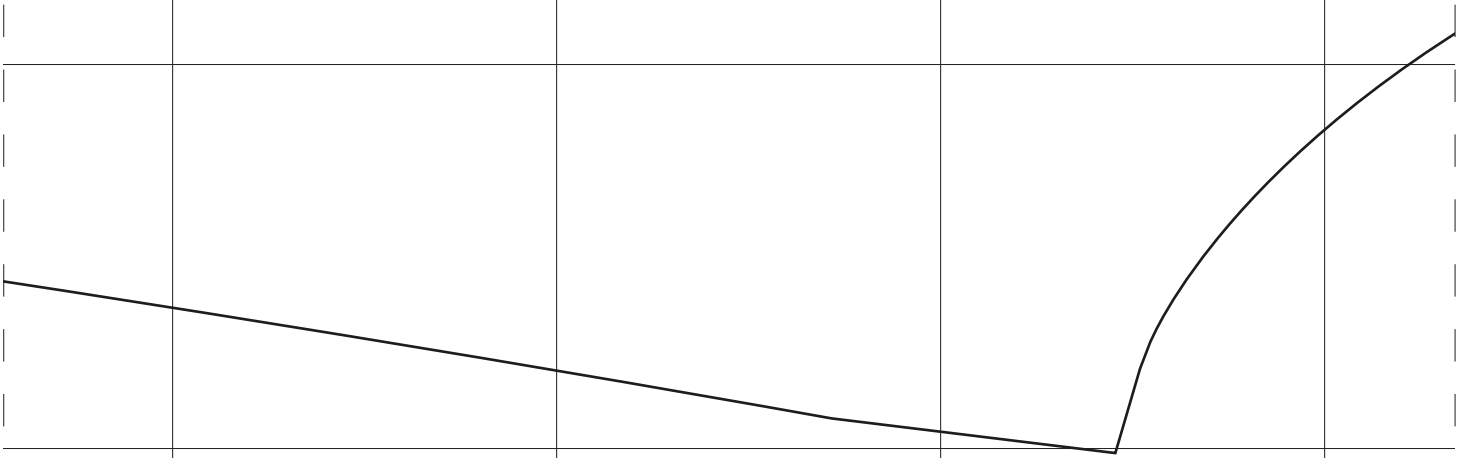

B4

B4

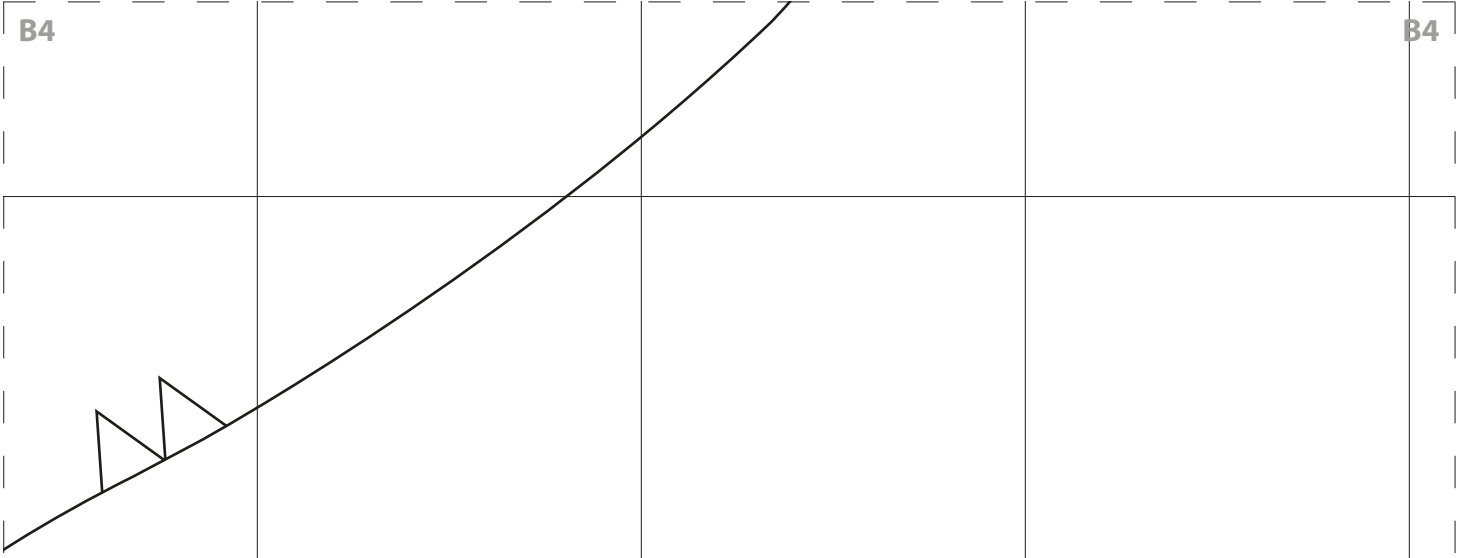

B4

B4

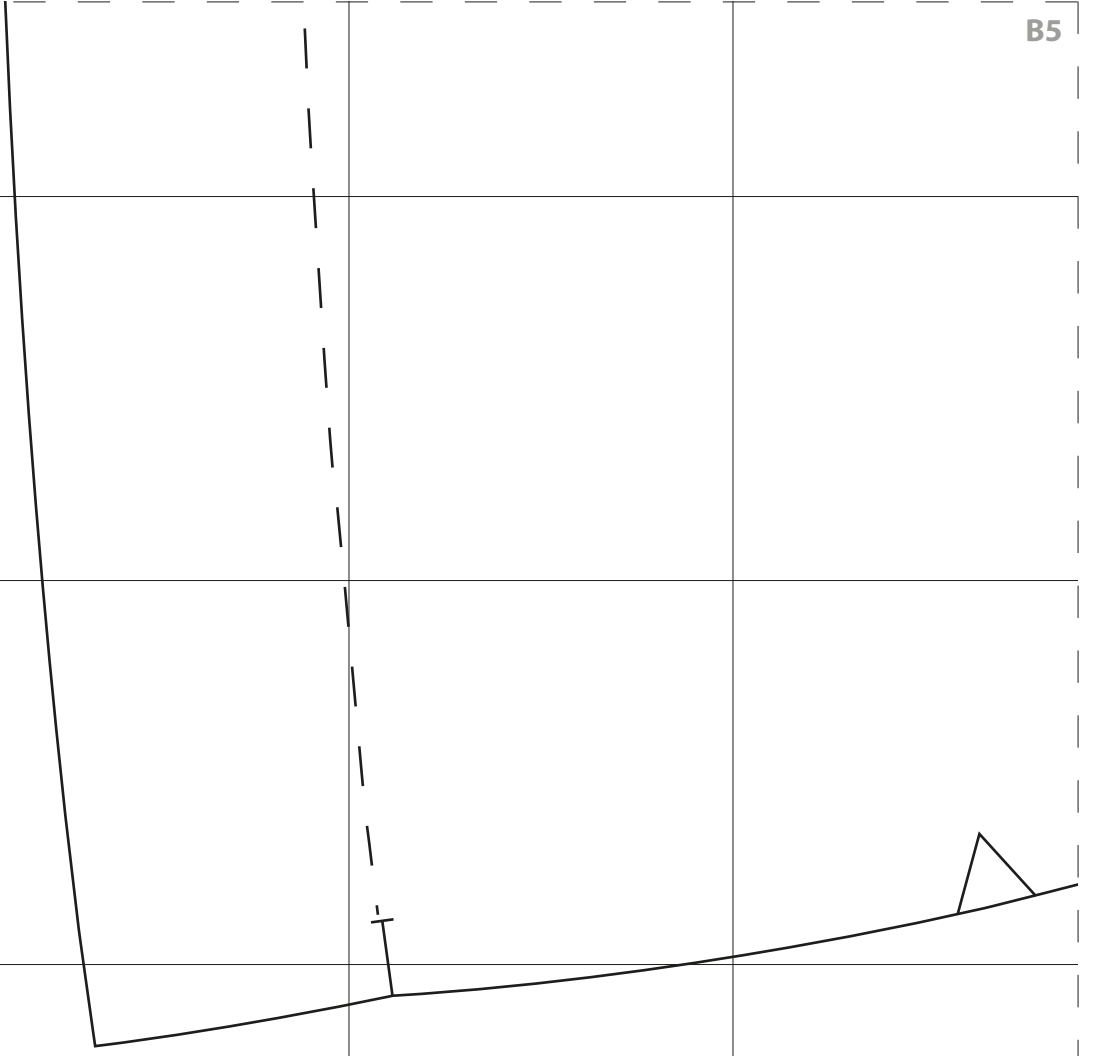

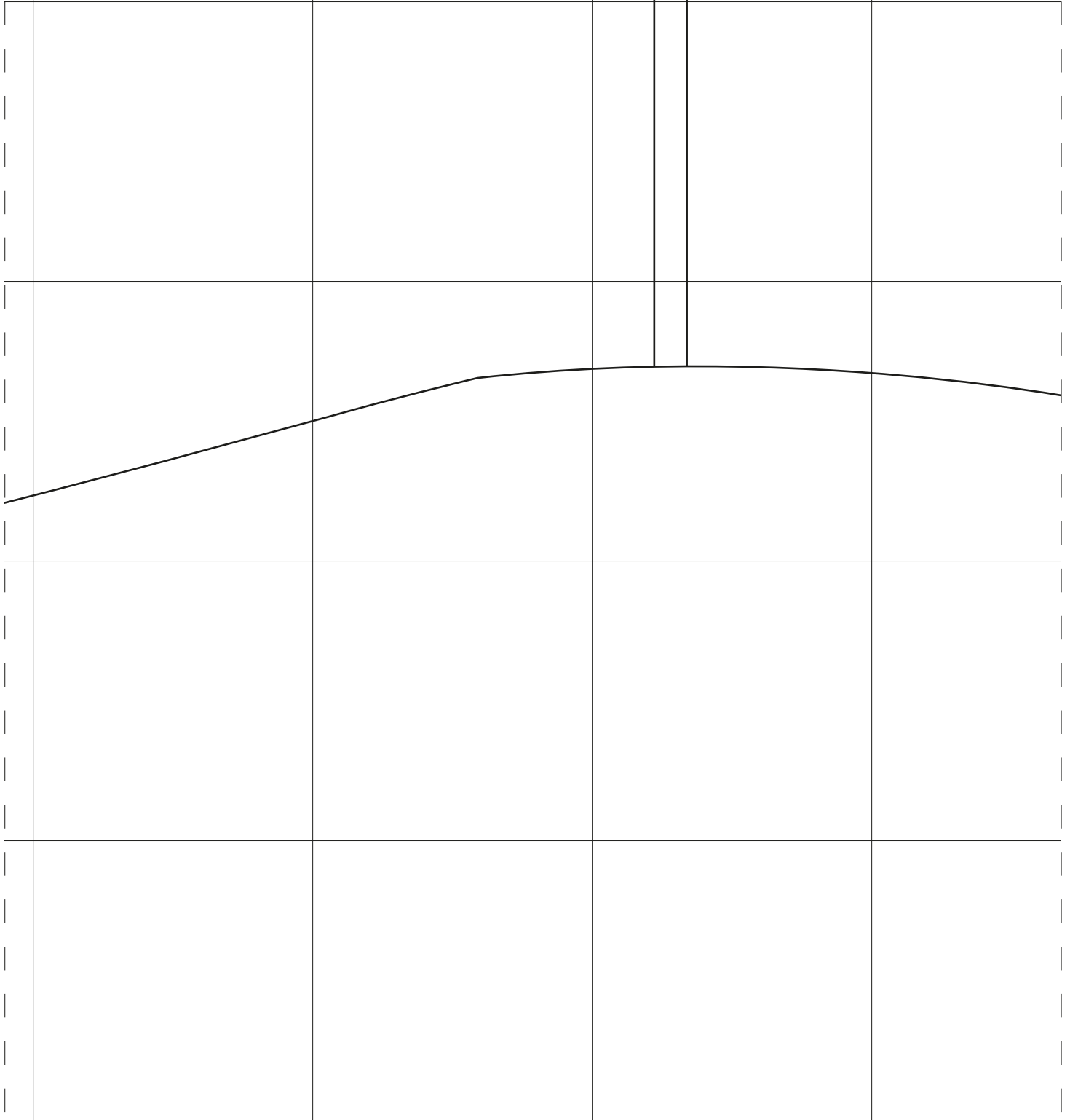

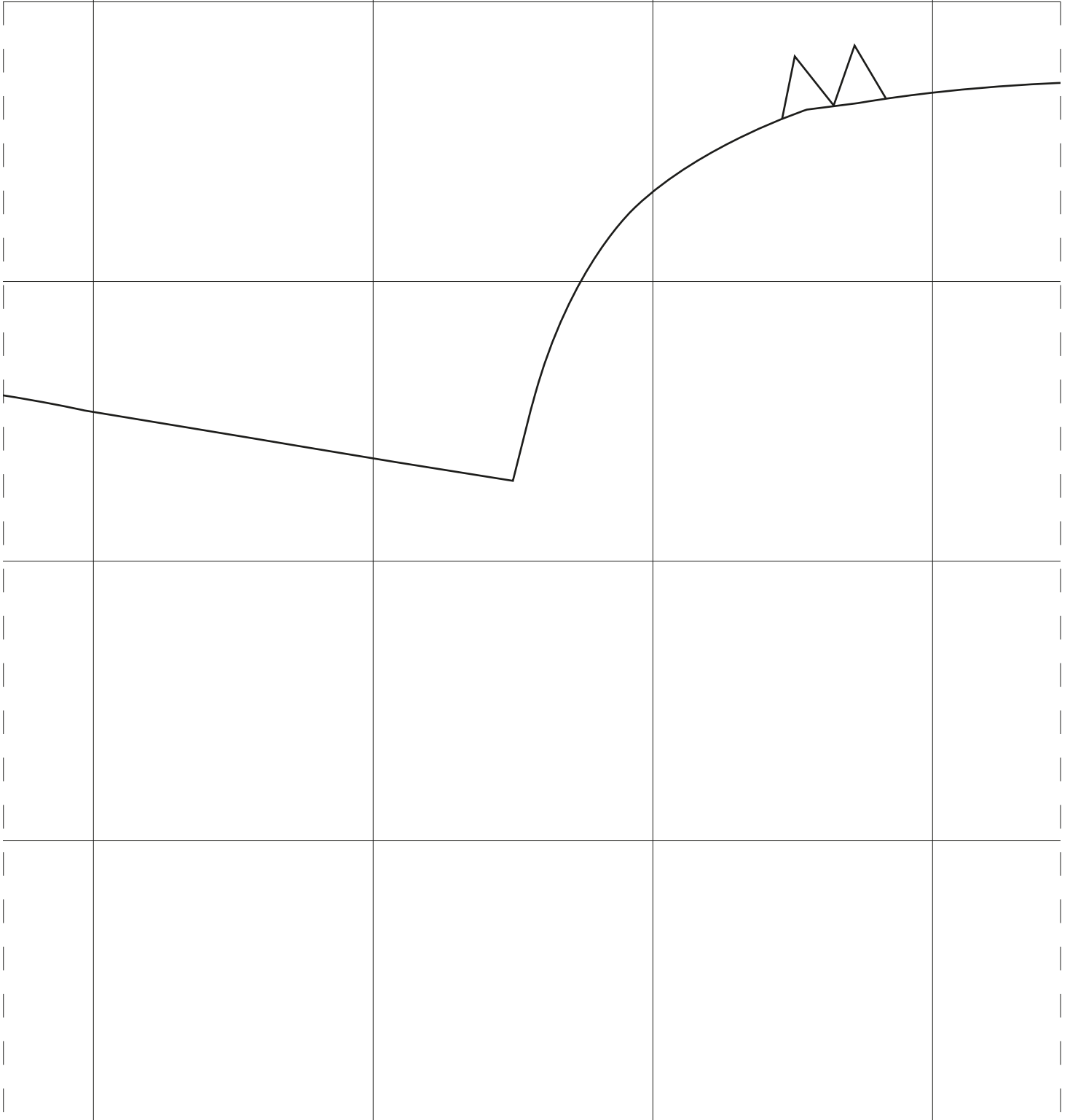

B8

B8

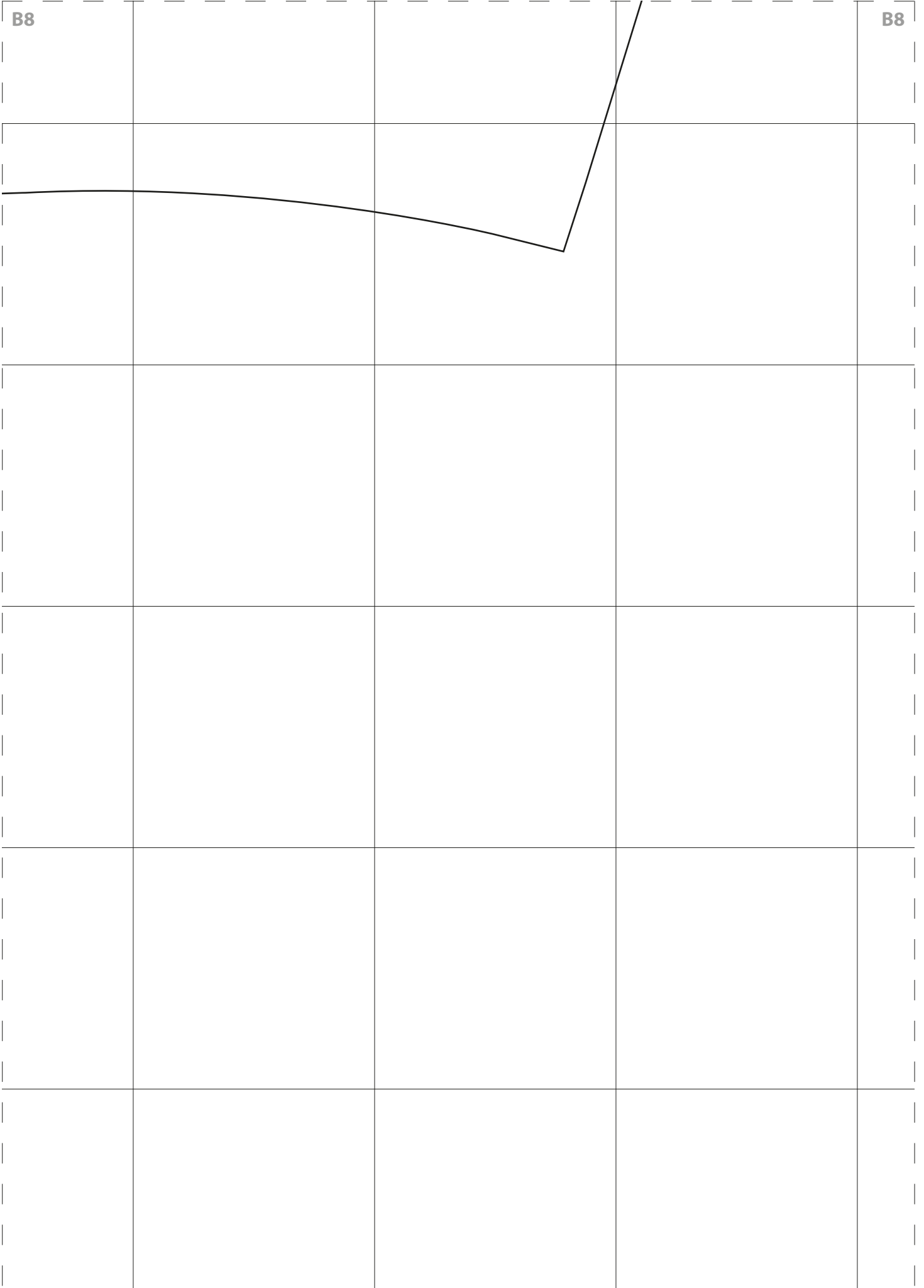

B8

B8



C1

C1

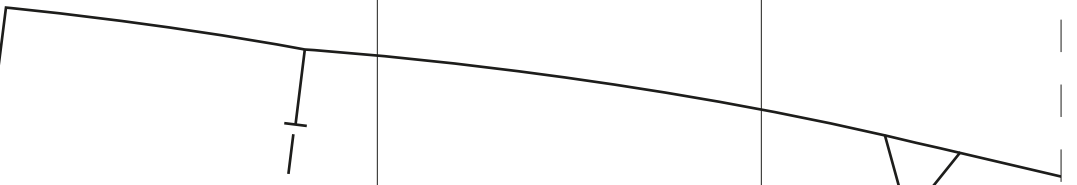

C1

C1

C2

C2

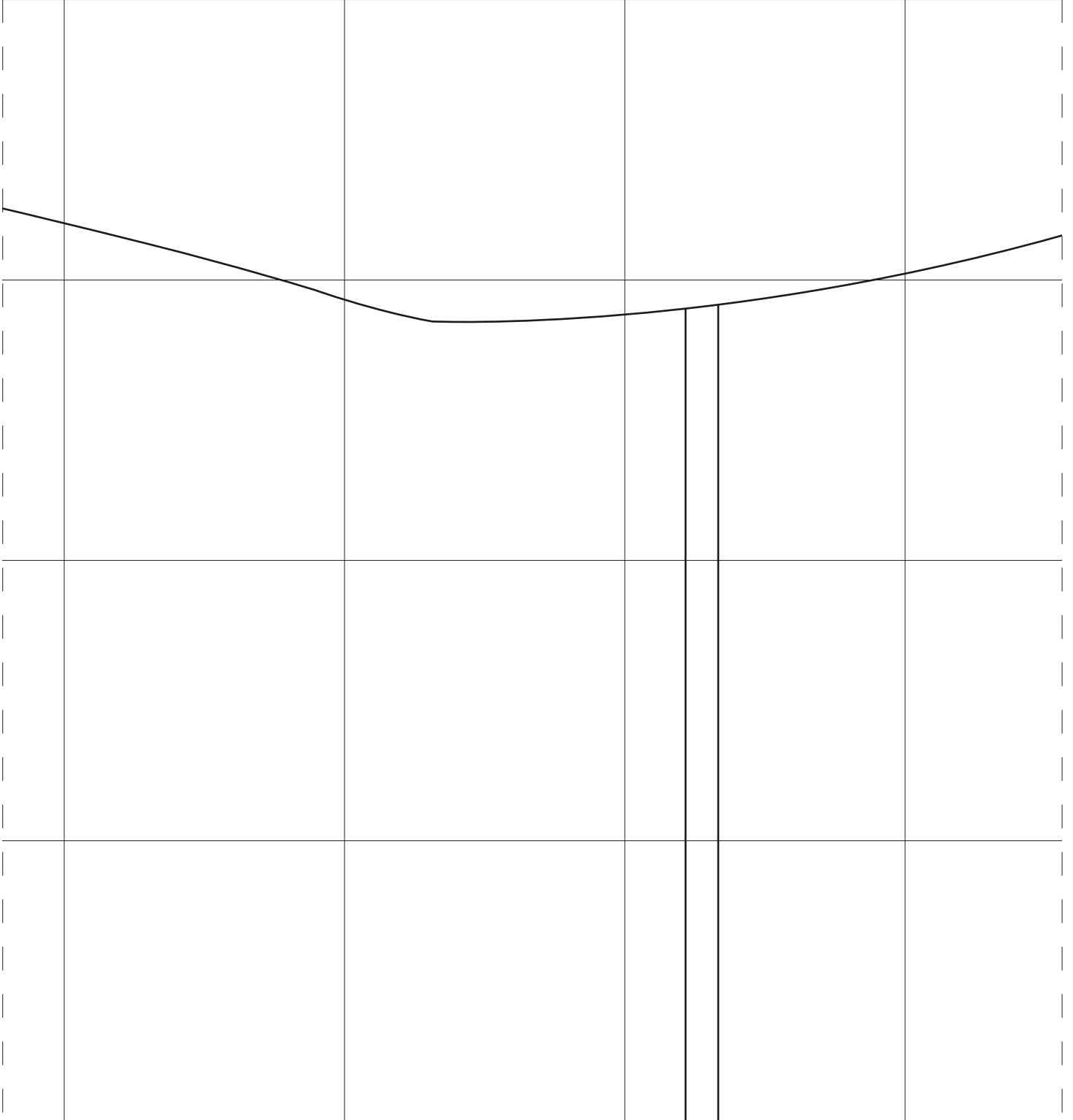

C2

C2

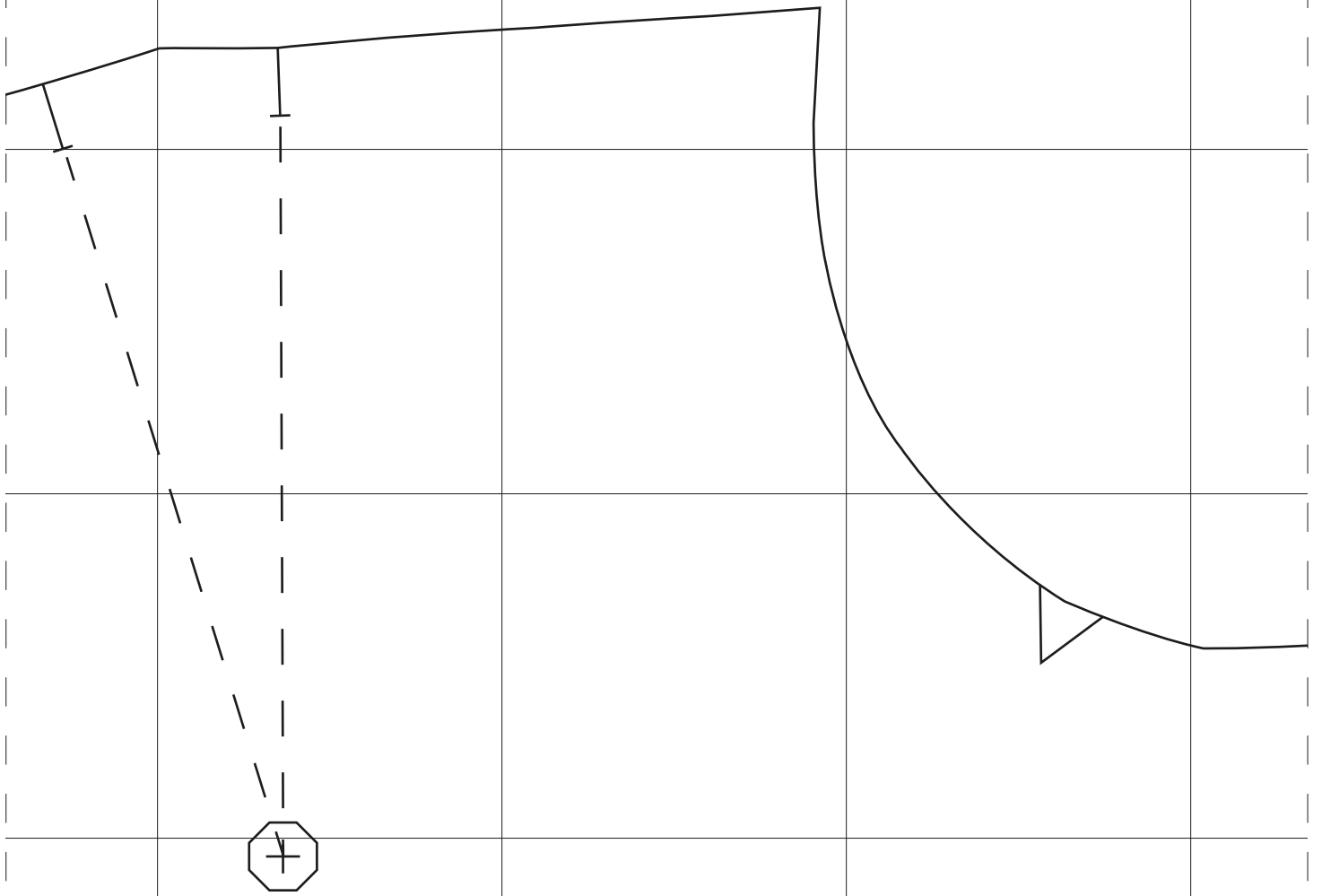

TOP FRONT  
Cut 1 on folded fabric

C4

C4

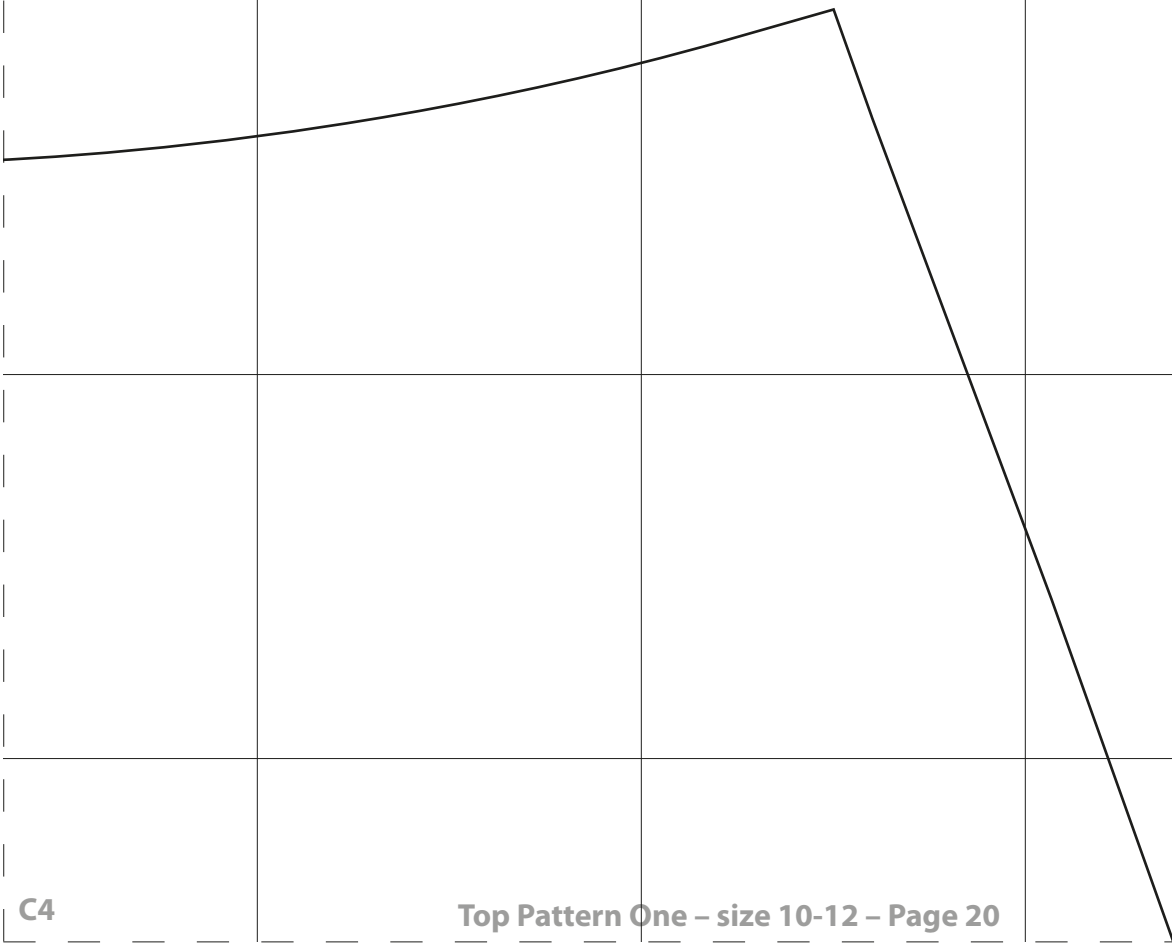

C4

C4

CB

BACK  
FACING

Cut 2 fabric  
Cut 2 interfacing



D1

D1

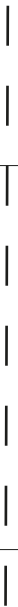

D1

D1

D2

D2

D2

D2

D3

D3

FOLD

D3

D3



D4

D4

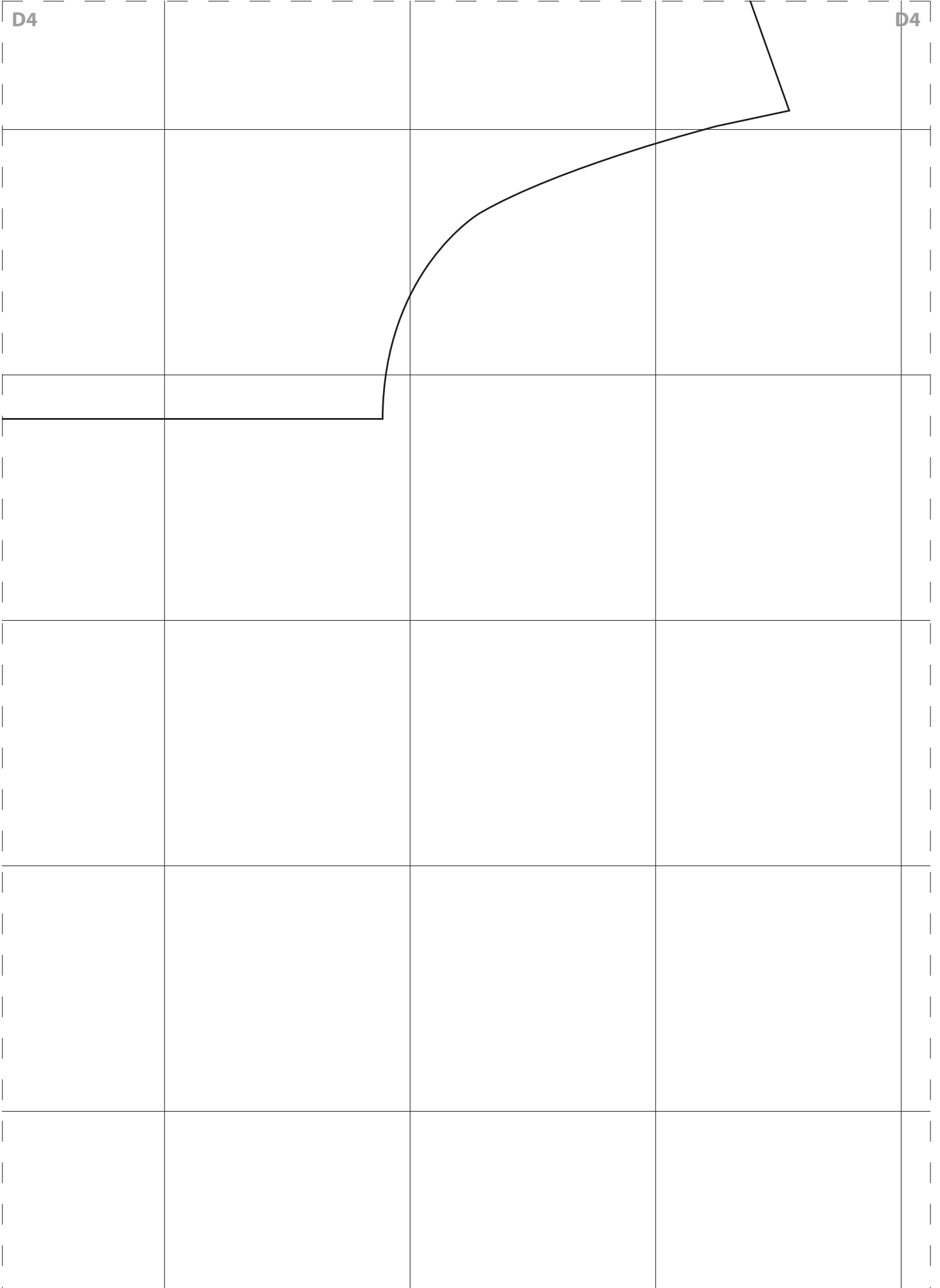

D4

D4

