

A1

A1

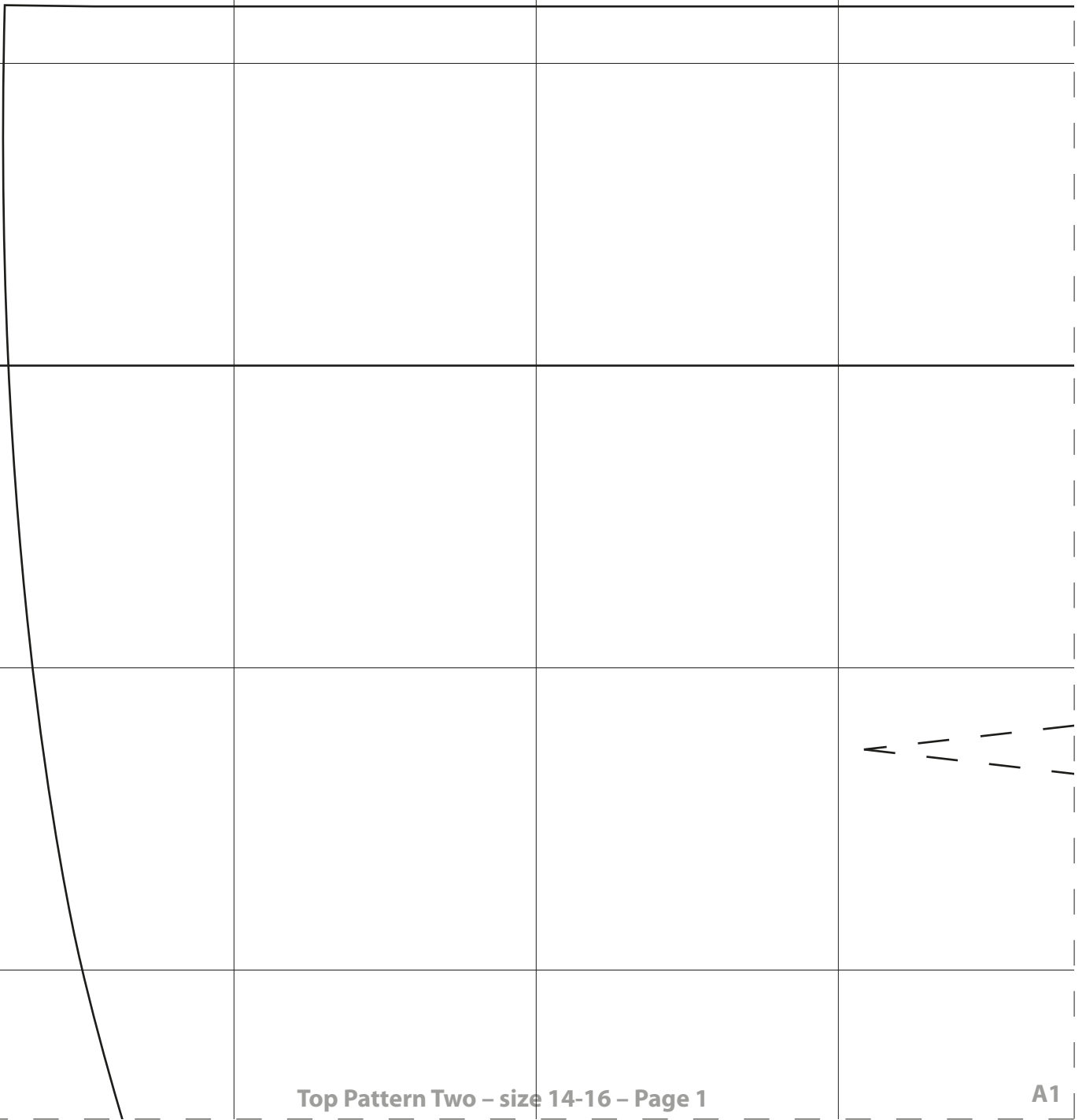

A1

A1

FOLD

TOP BACK
Cut 1 on folded fabric

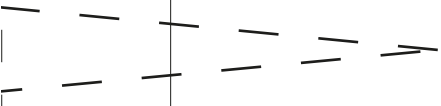

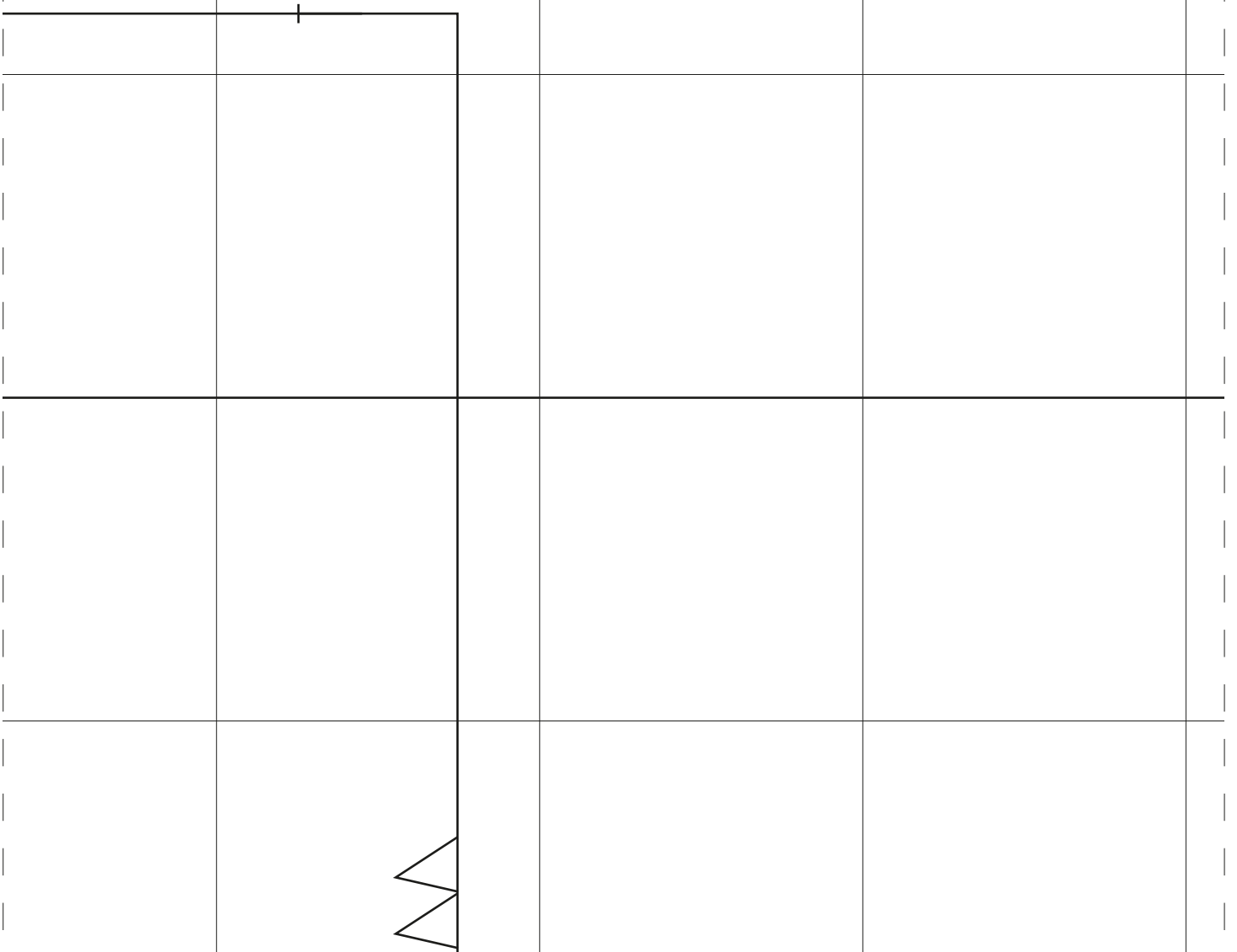

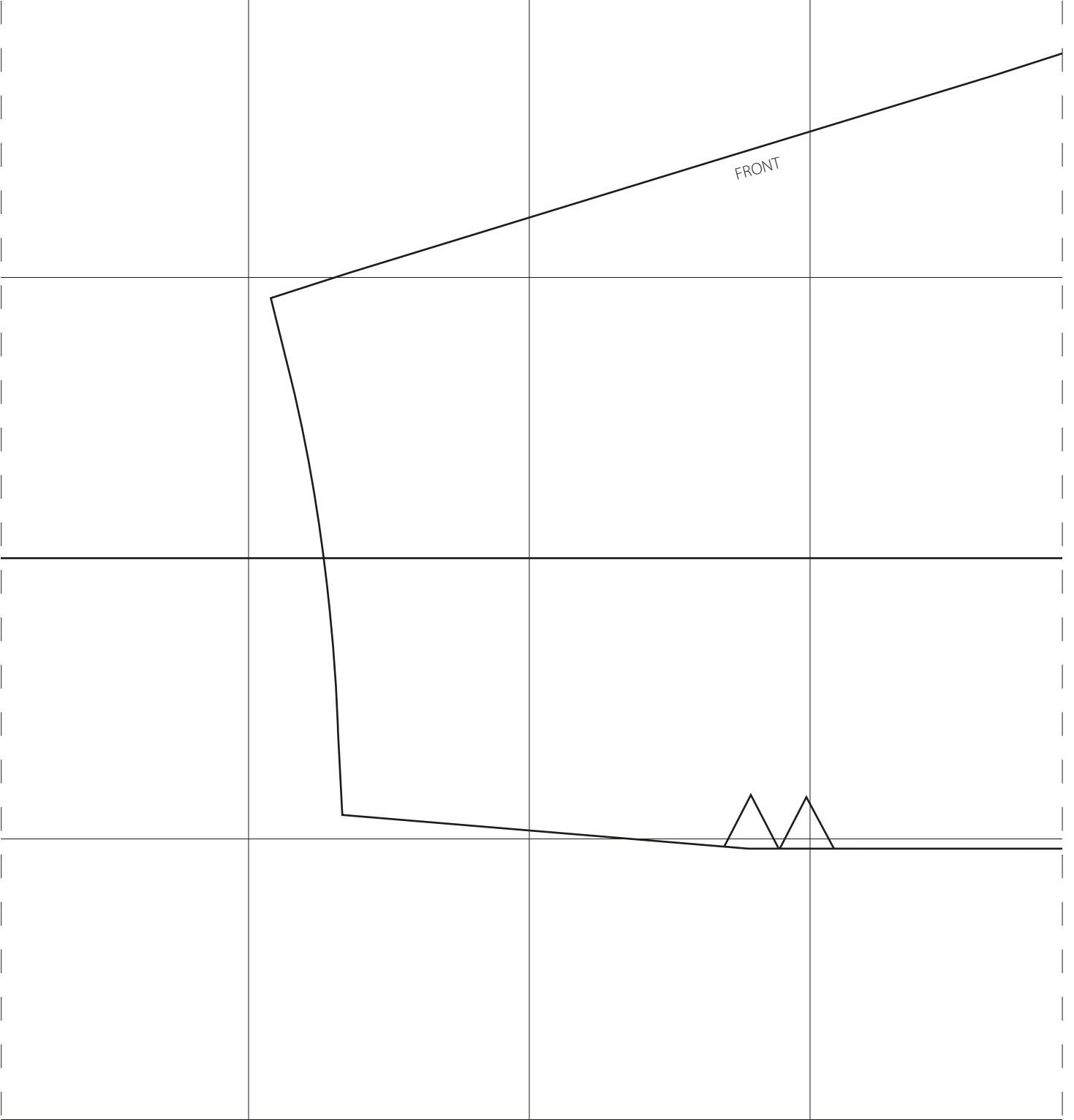

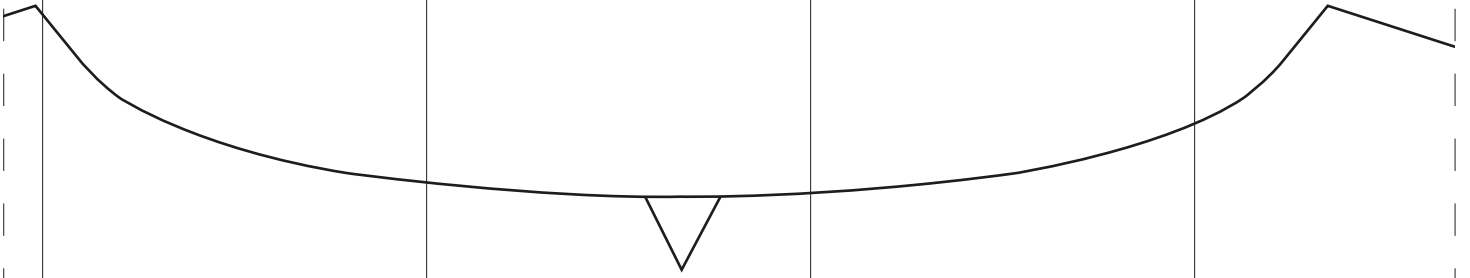

YOKE

Cut 2 fabric

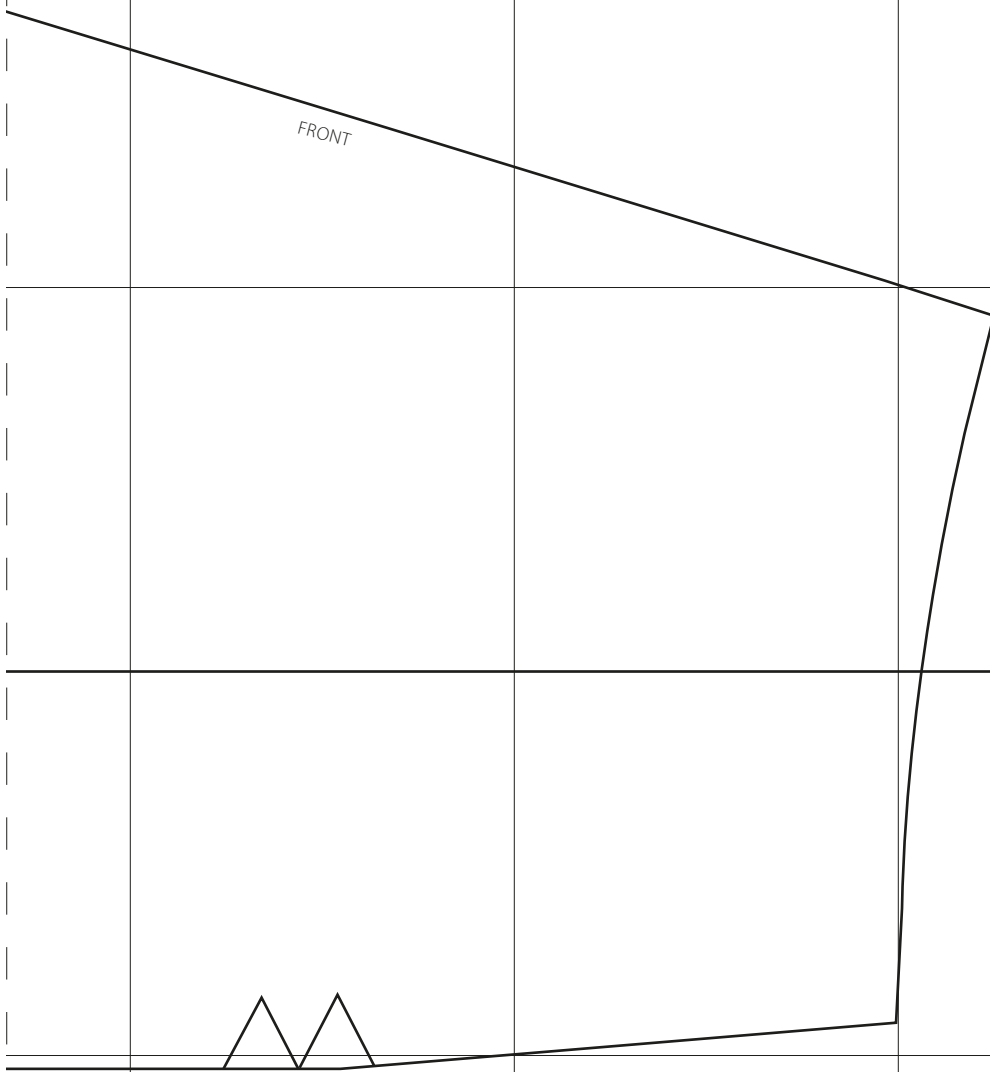

B1

B1

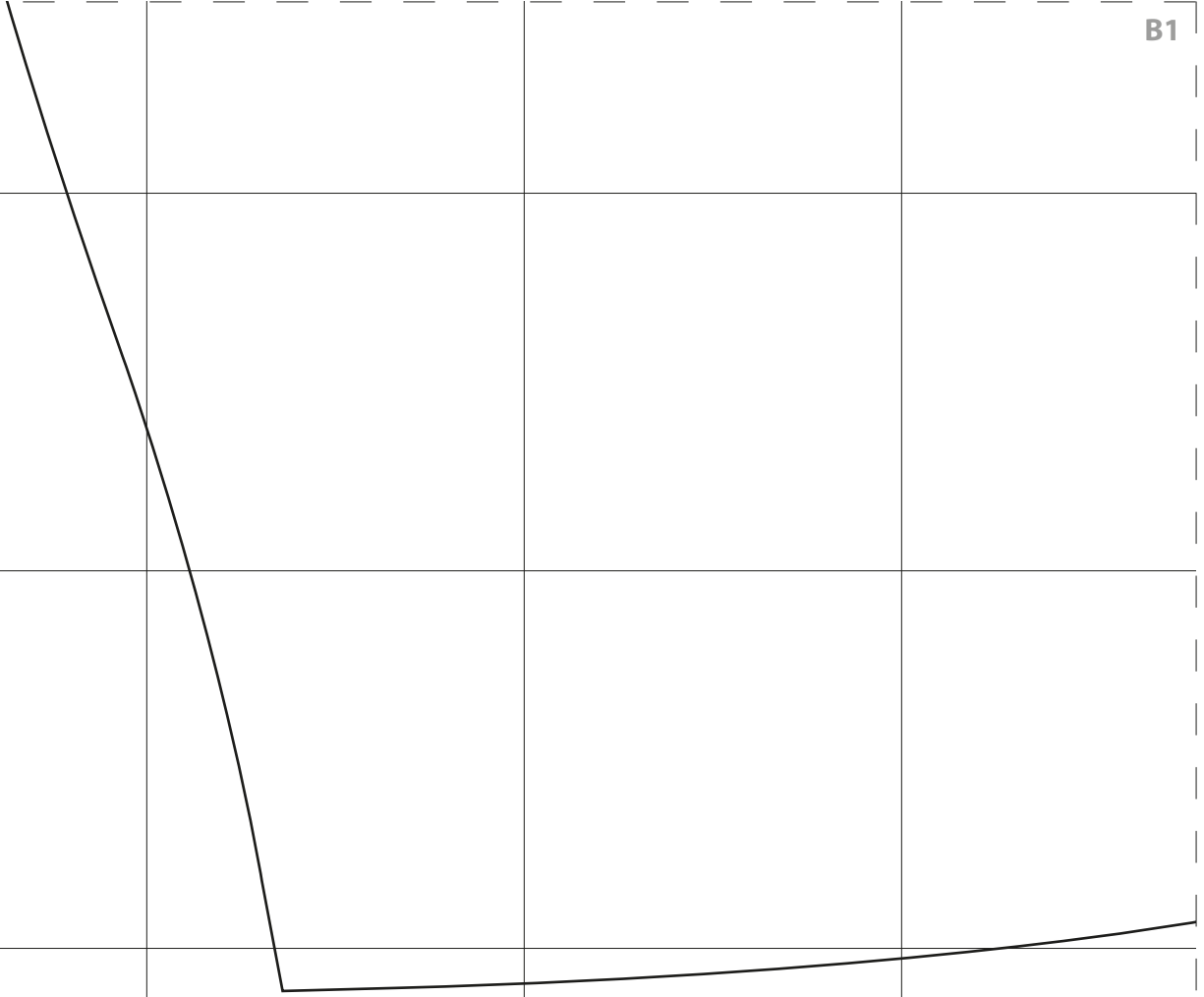

B1

B1



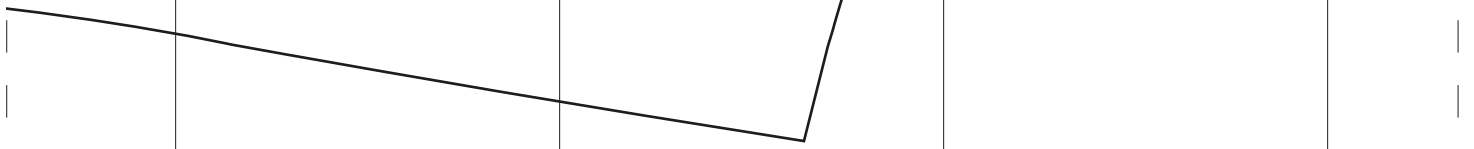



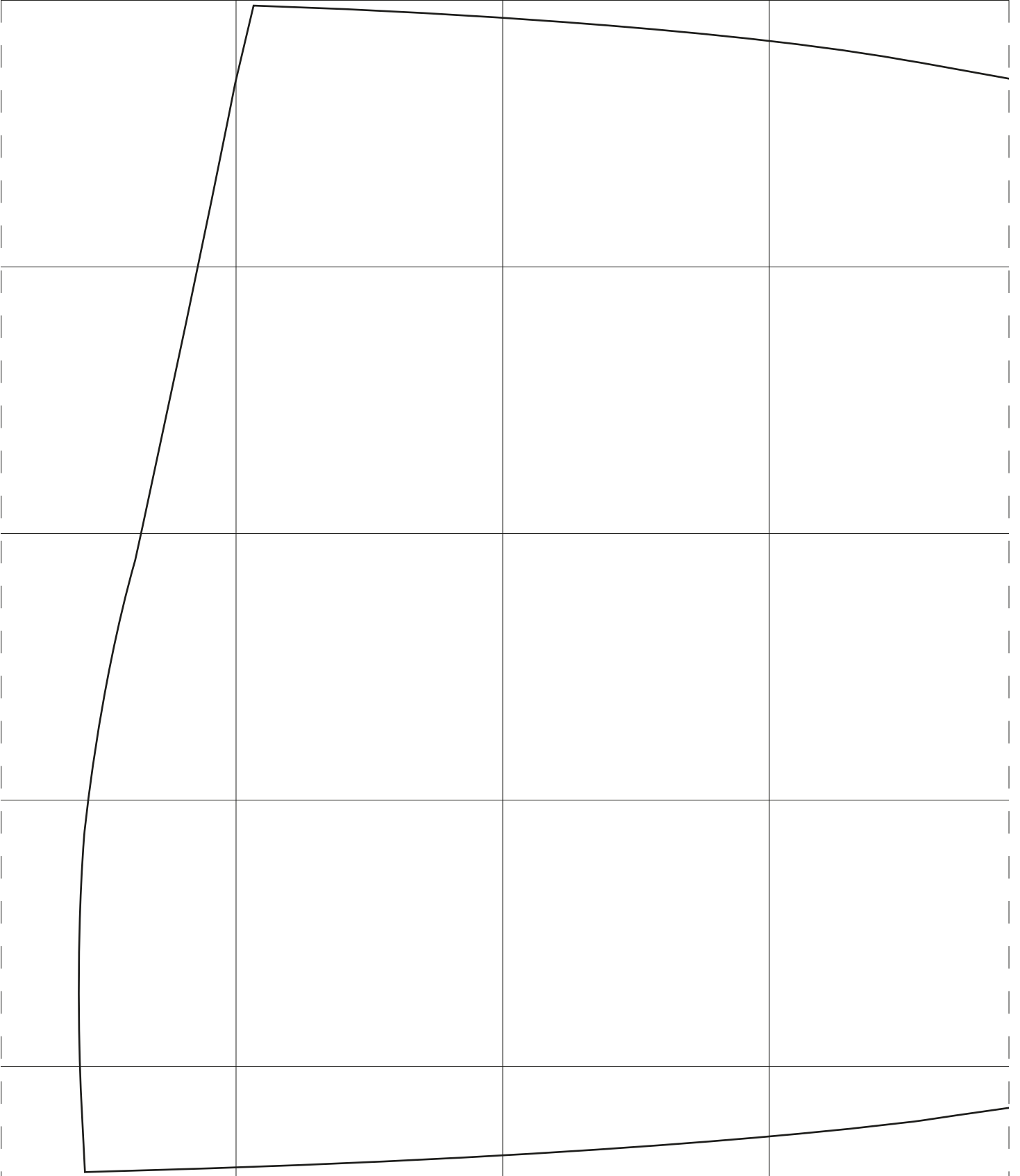

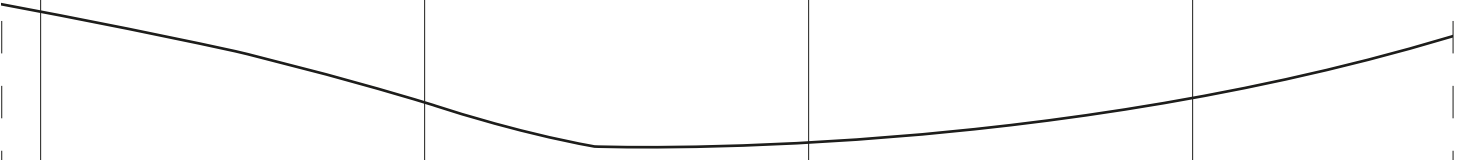

SIDE FRONT
Cut 2 fabric



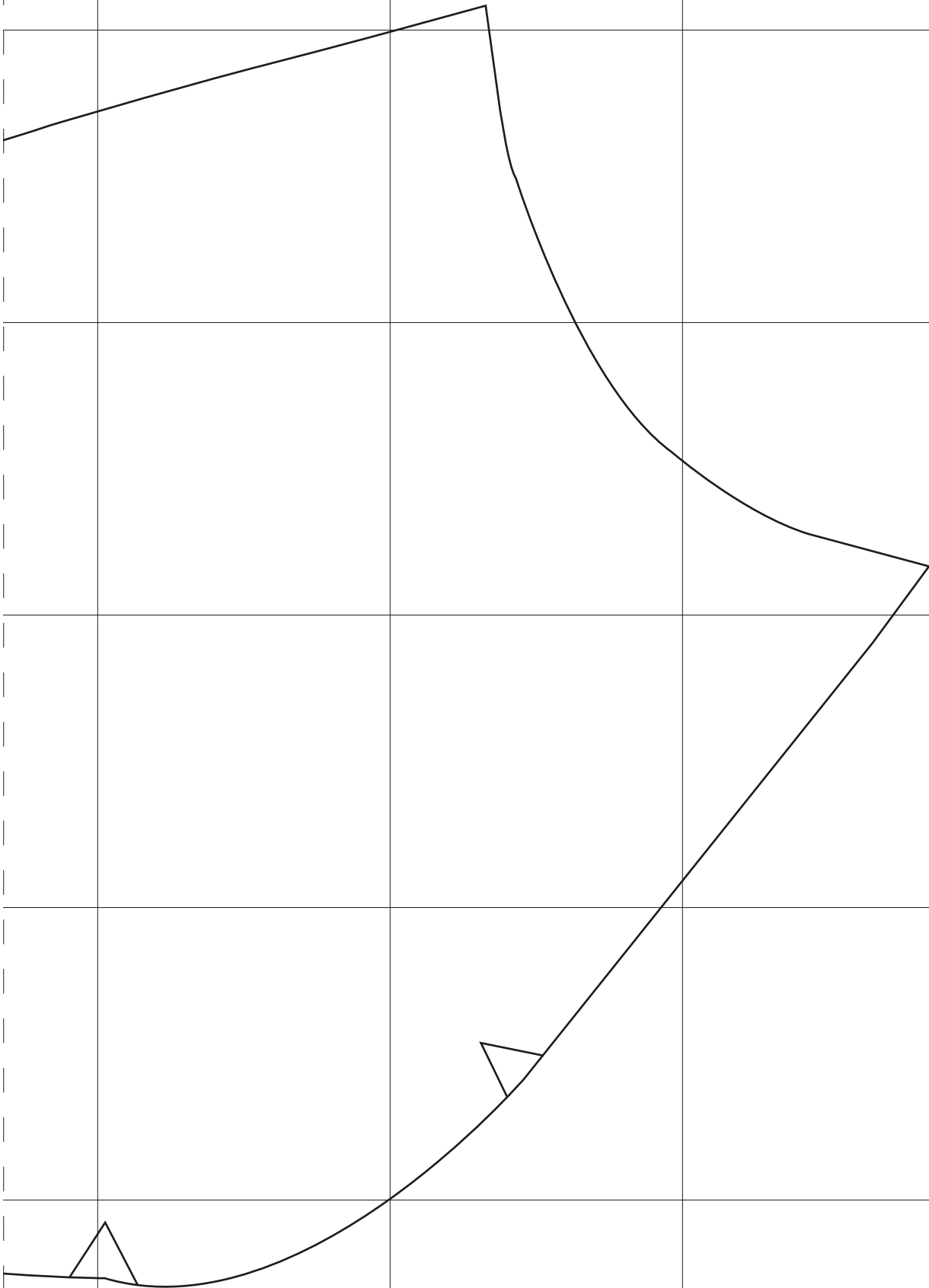

C1

C1

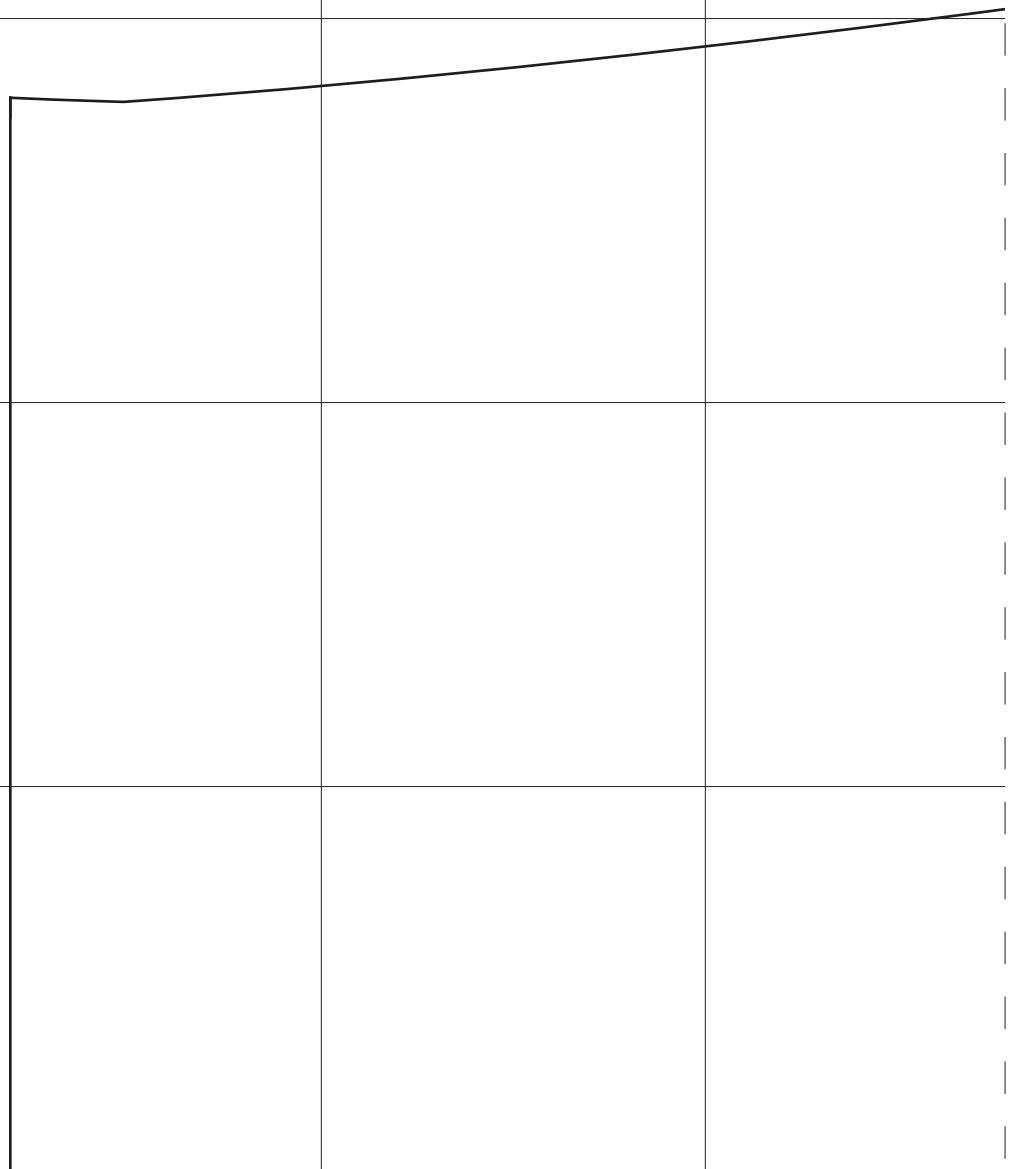

C1

C1

C2

C2

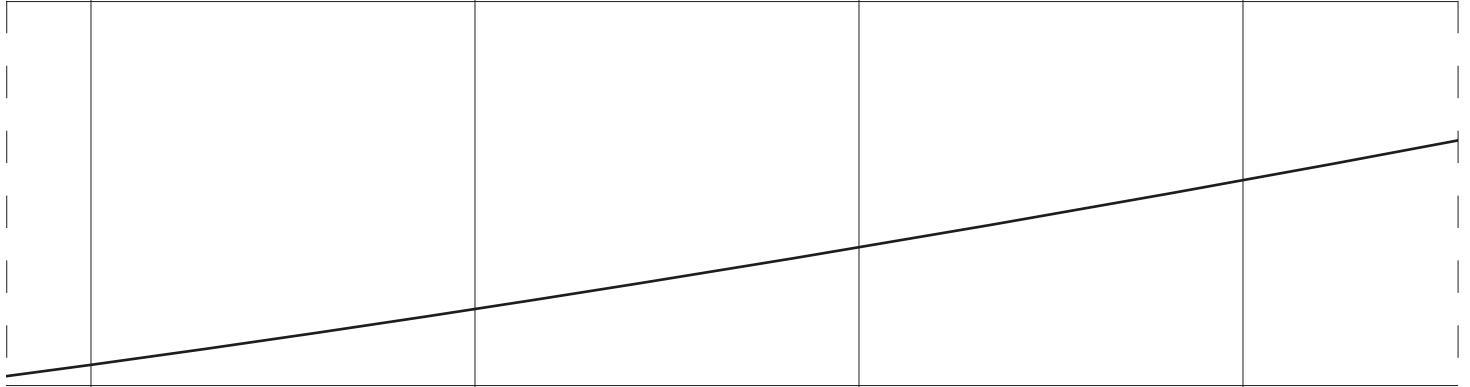

SLEEVE
Cut 2 fabric

C2

C2

C3

C3

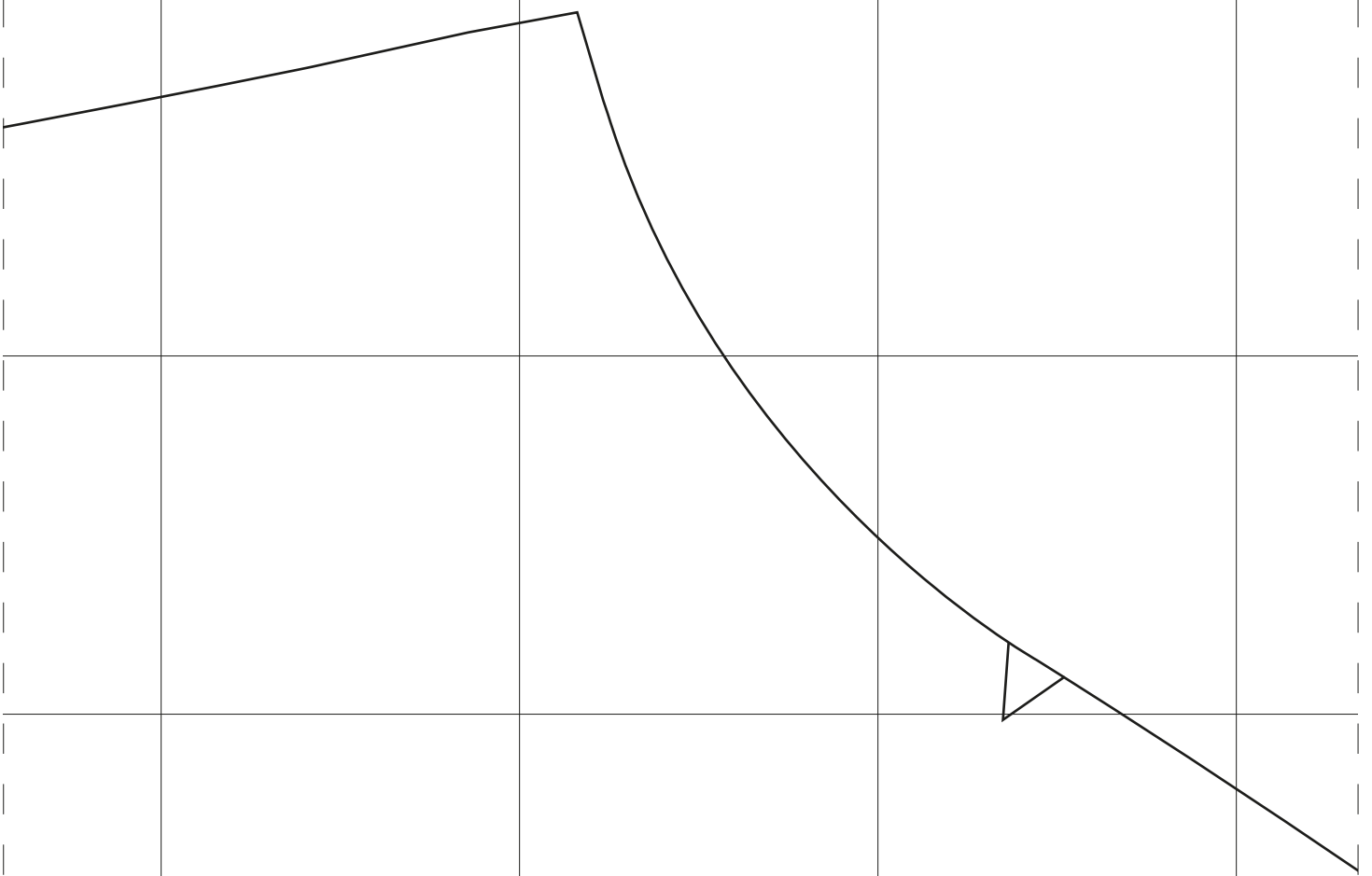

C3

C3

C4

C4

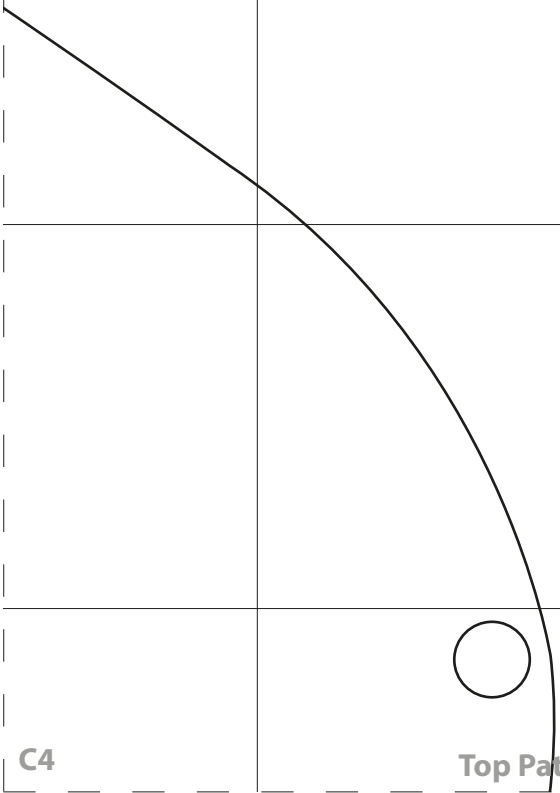

C4

C4

C5

C5

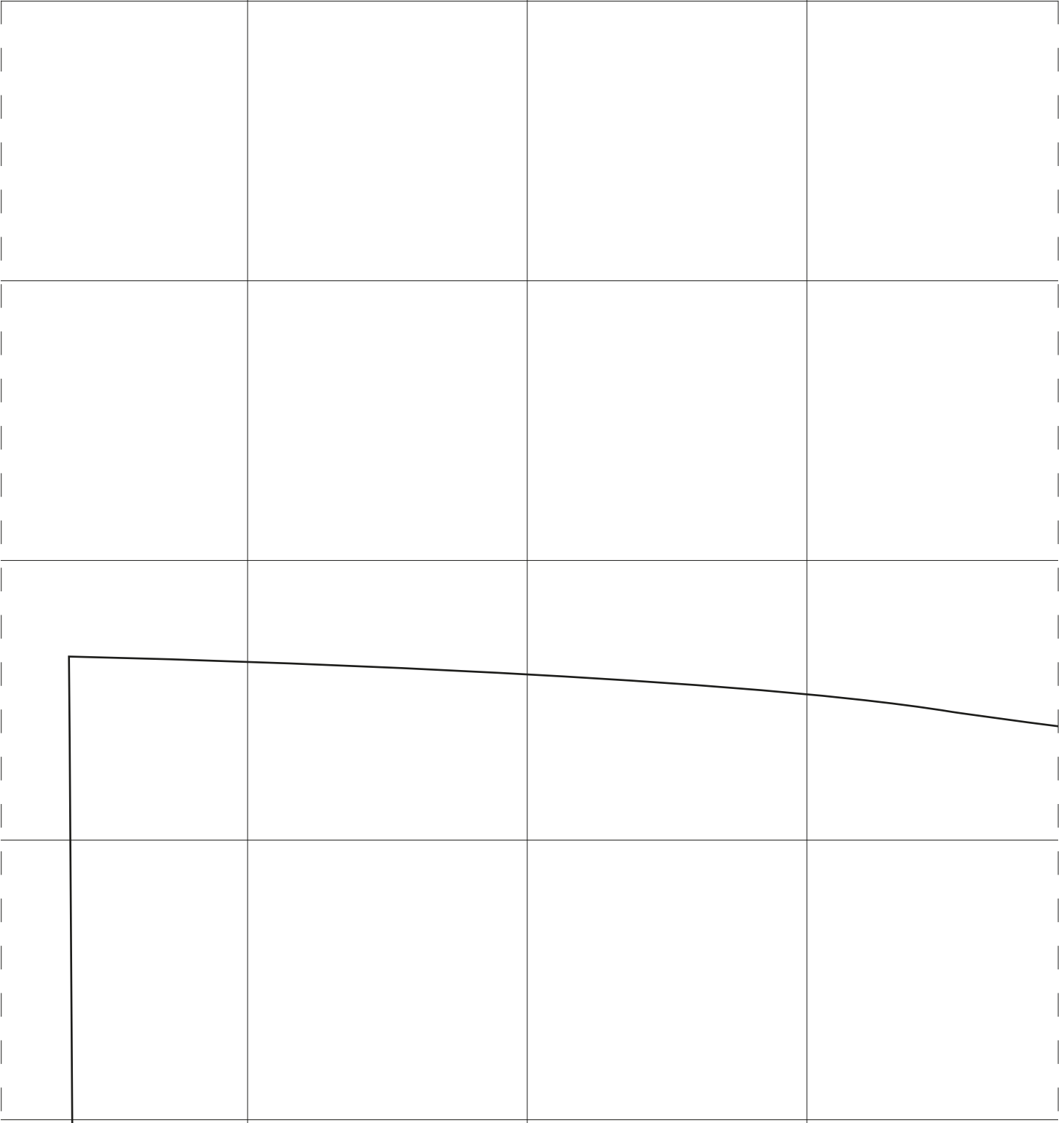

C5

C5

C6

C6



C6

C6

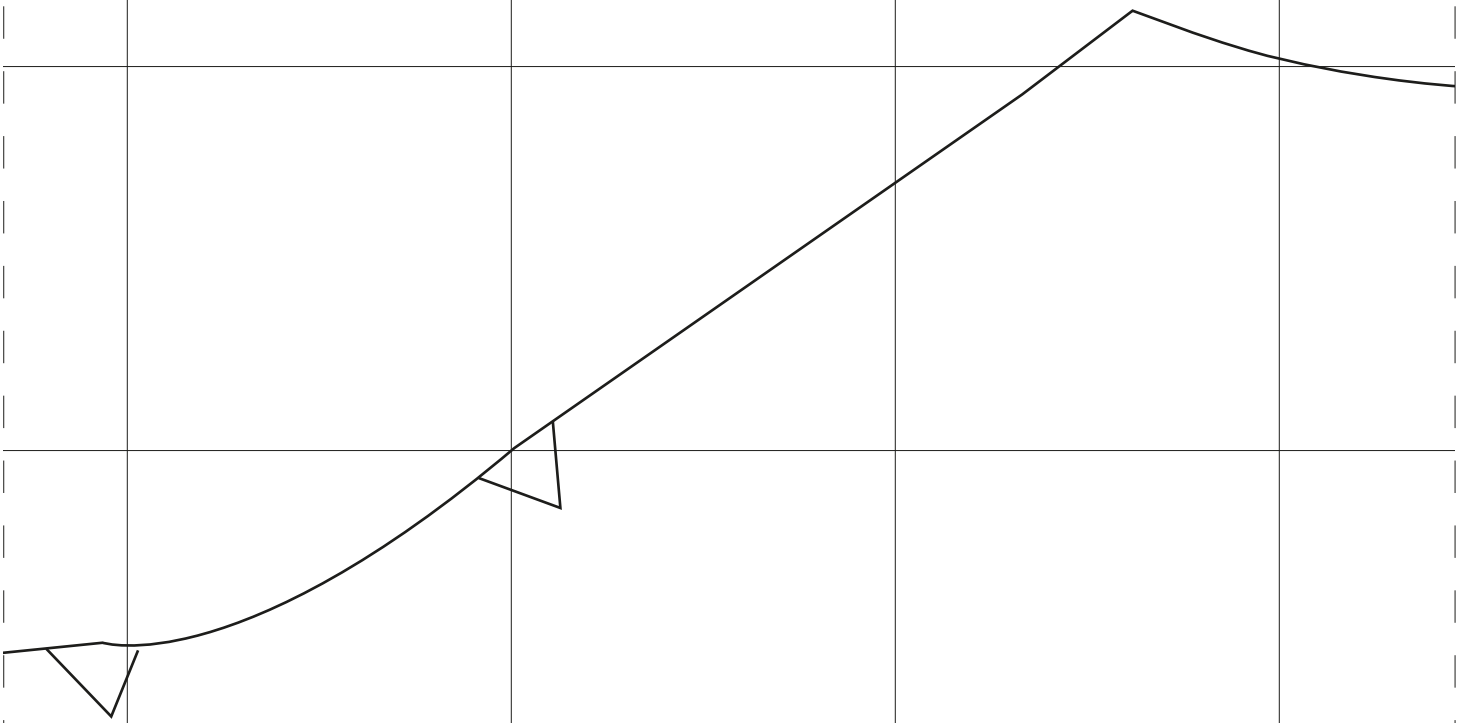

TOP FRONT

Cut 2 fabric

C8

C8

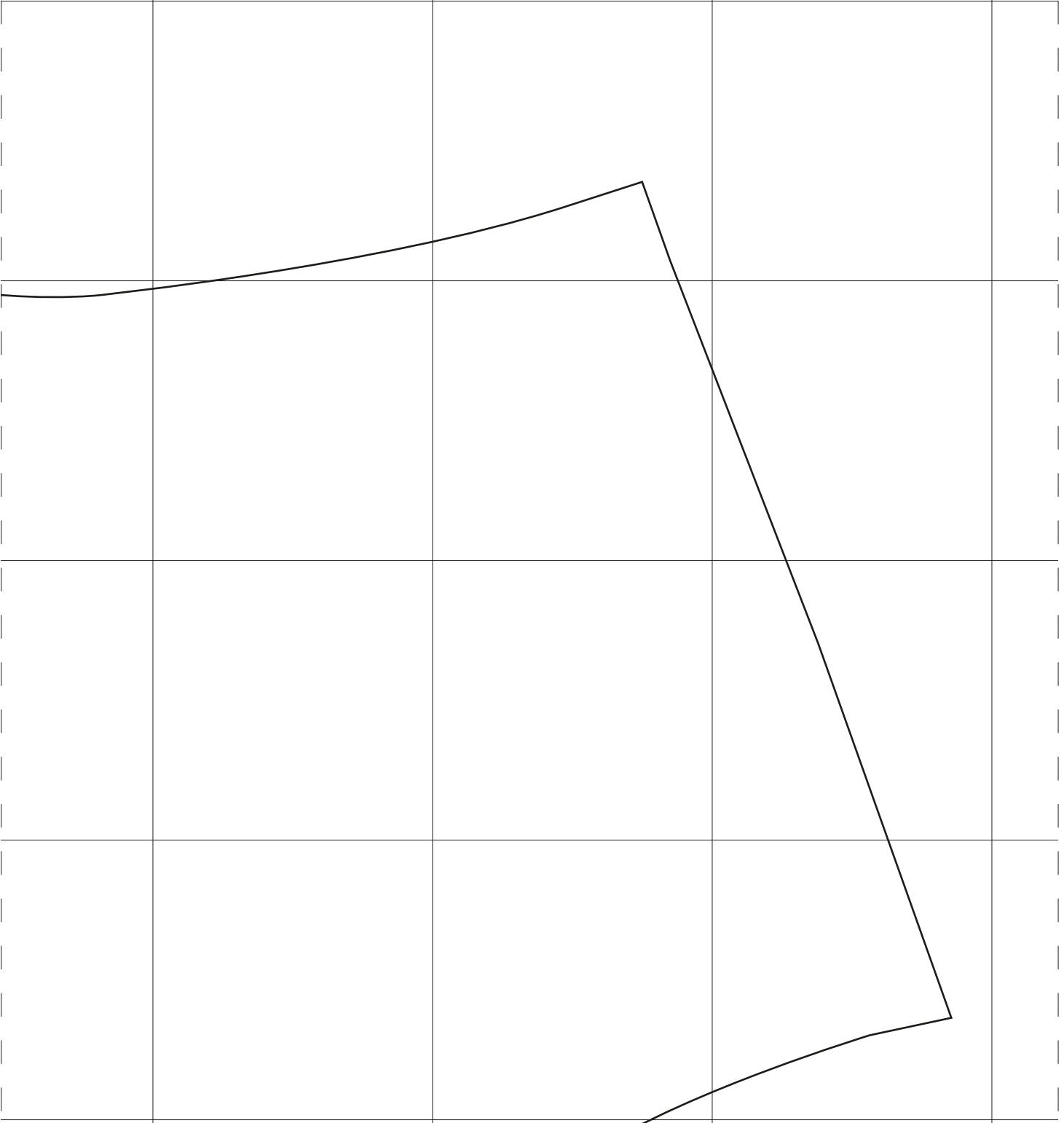

C8

C8

D1

D1



D1

D1

D2

D2

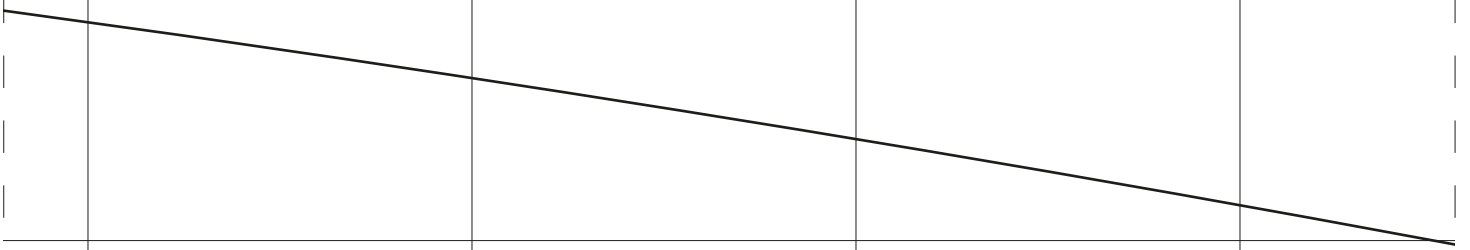

D2

D2

D3

D3

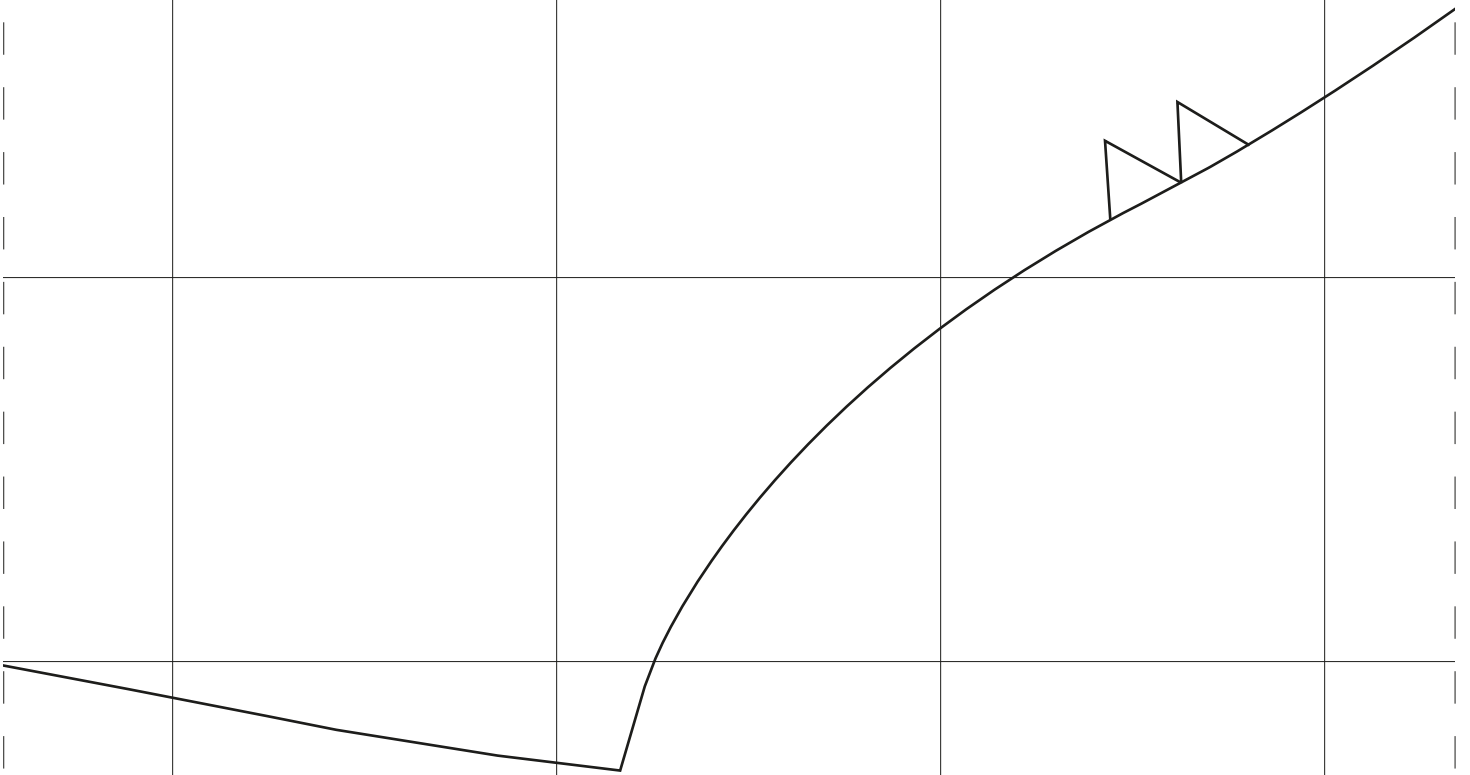

D3

D3

D4

D4

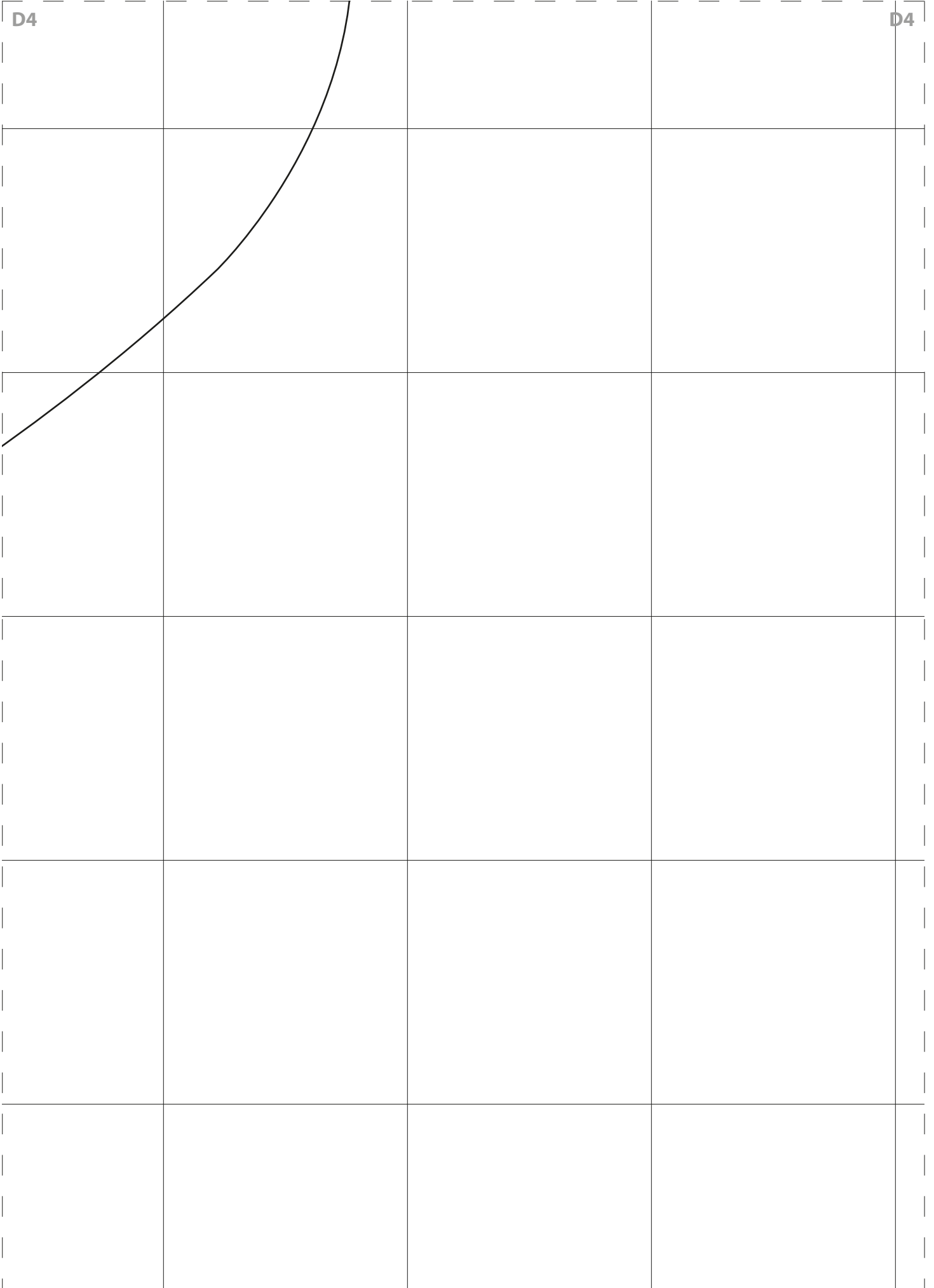

D4

D4

D5

D5

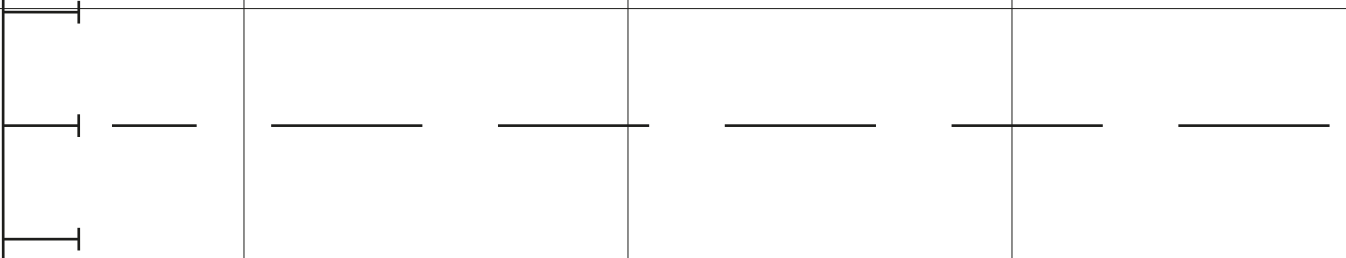

D5

D5

D6

D6

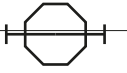
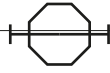
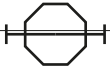

D6

D6

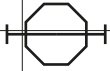

CF

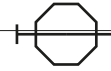

Interface



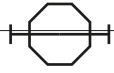

FOLD

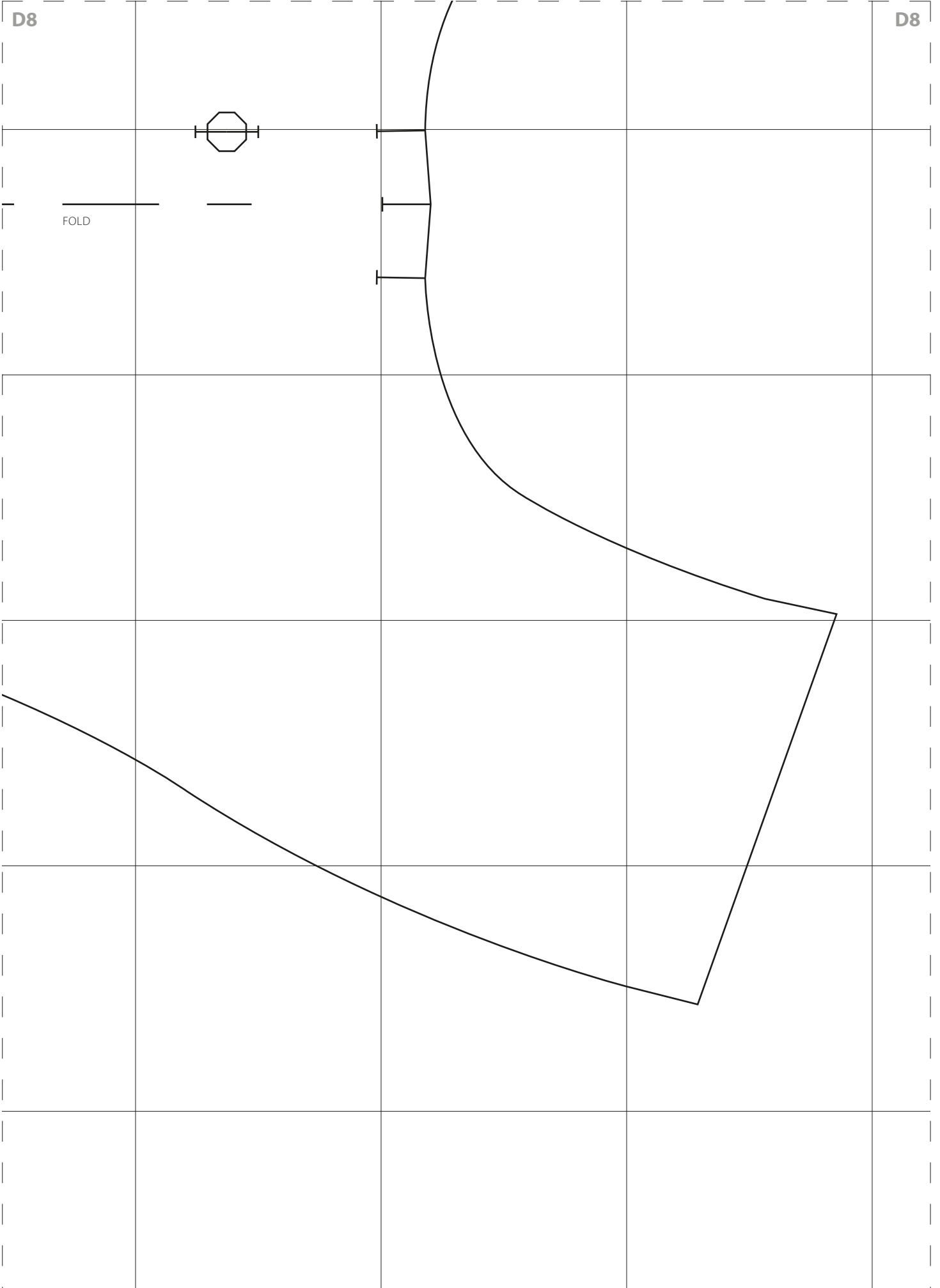

E1

E1

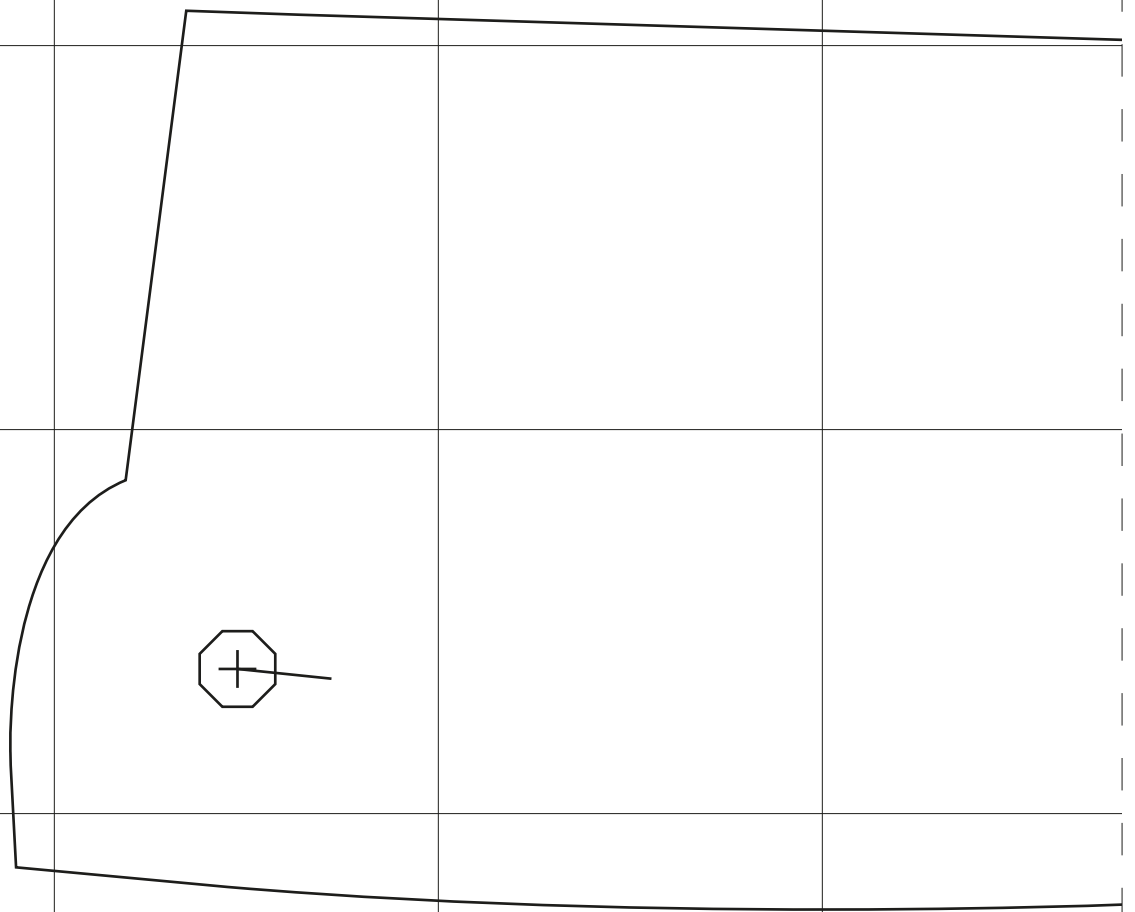

E1

E1



COLLAR
Cut 2 fabric
Cut 2 interfacing

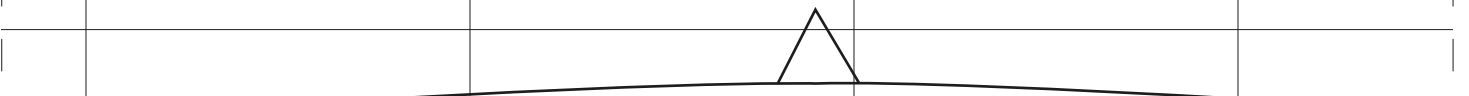

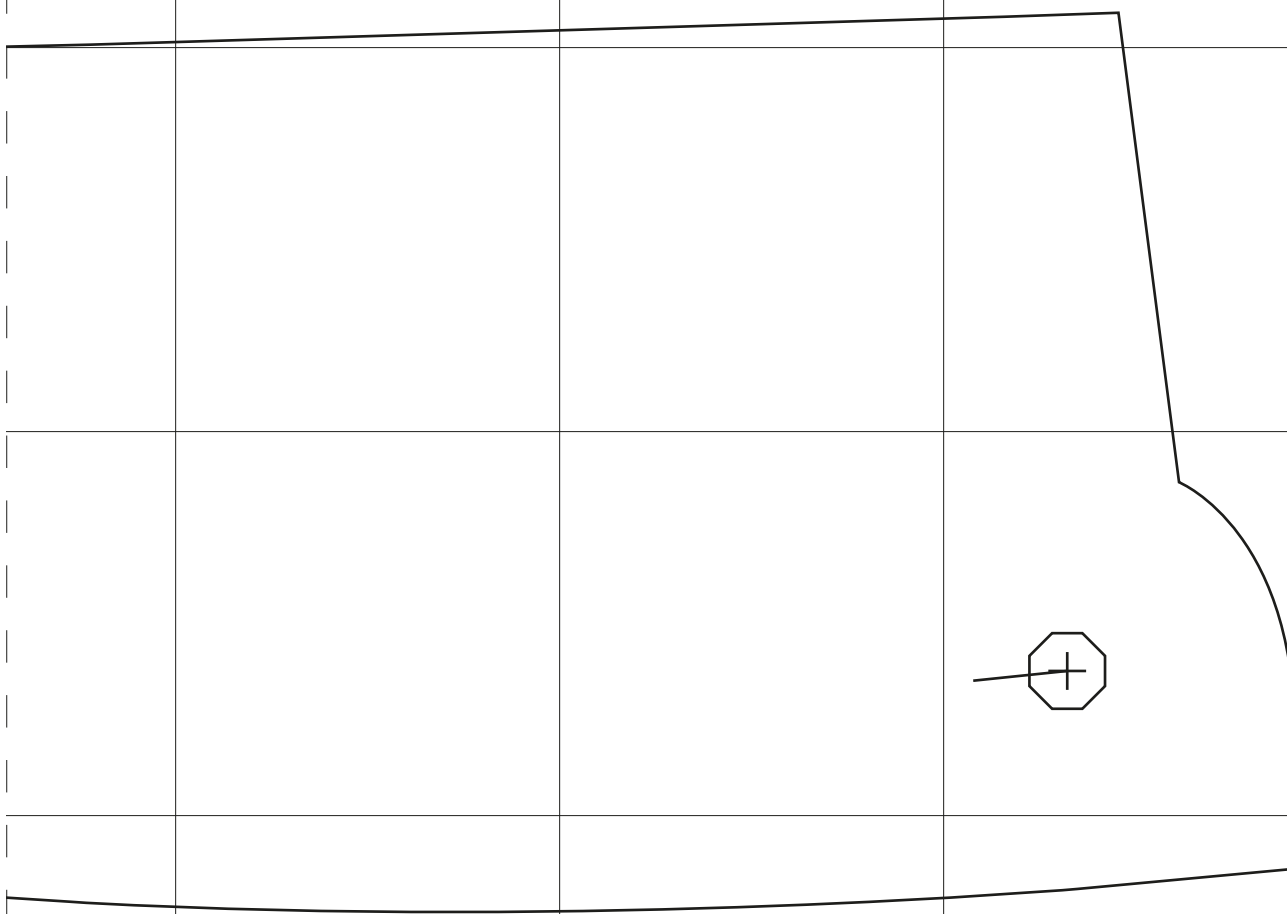

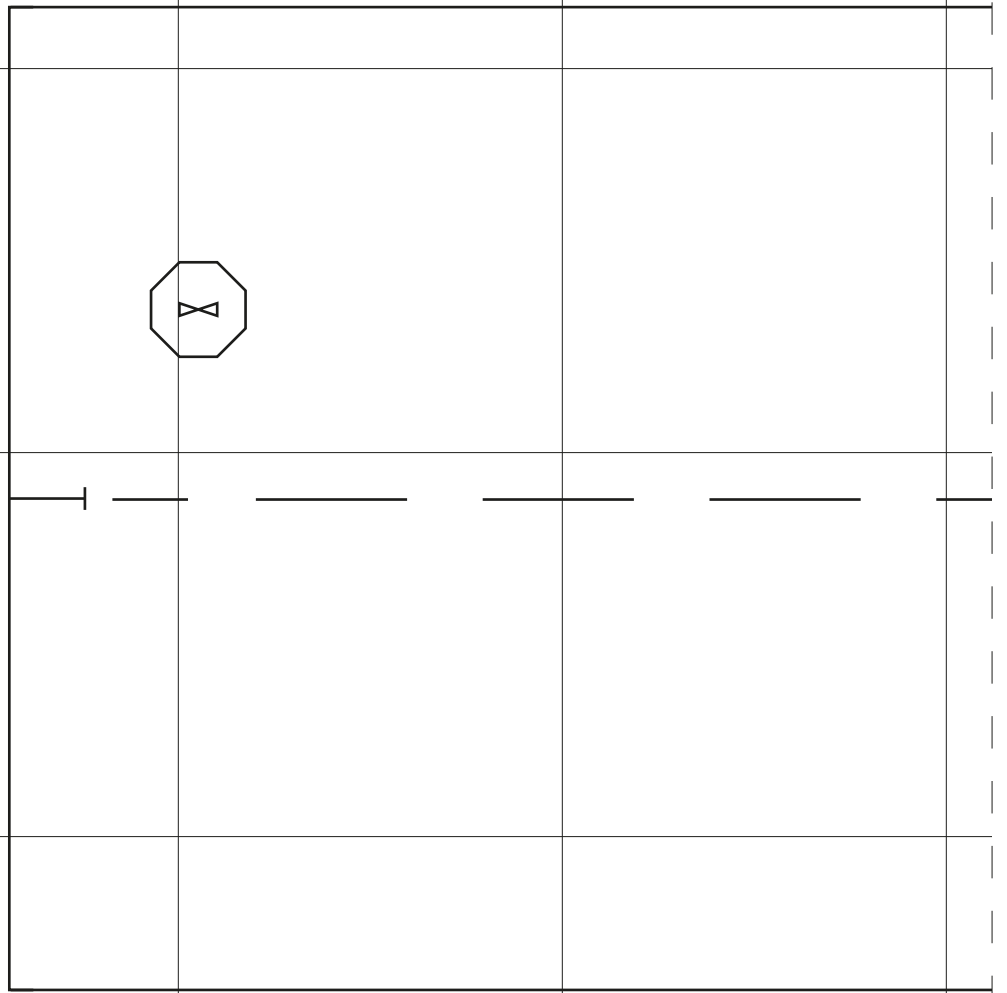

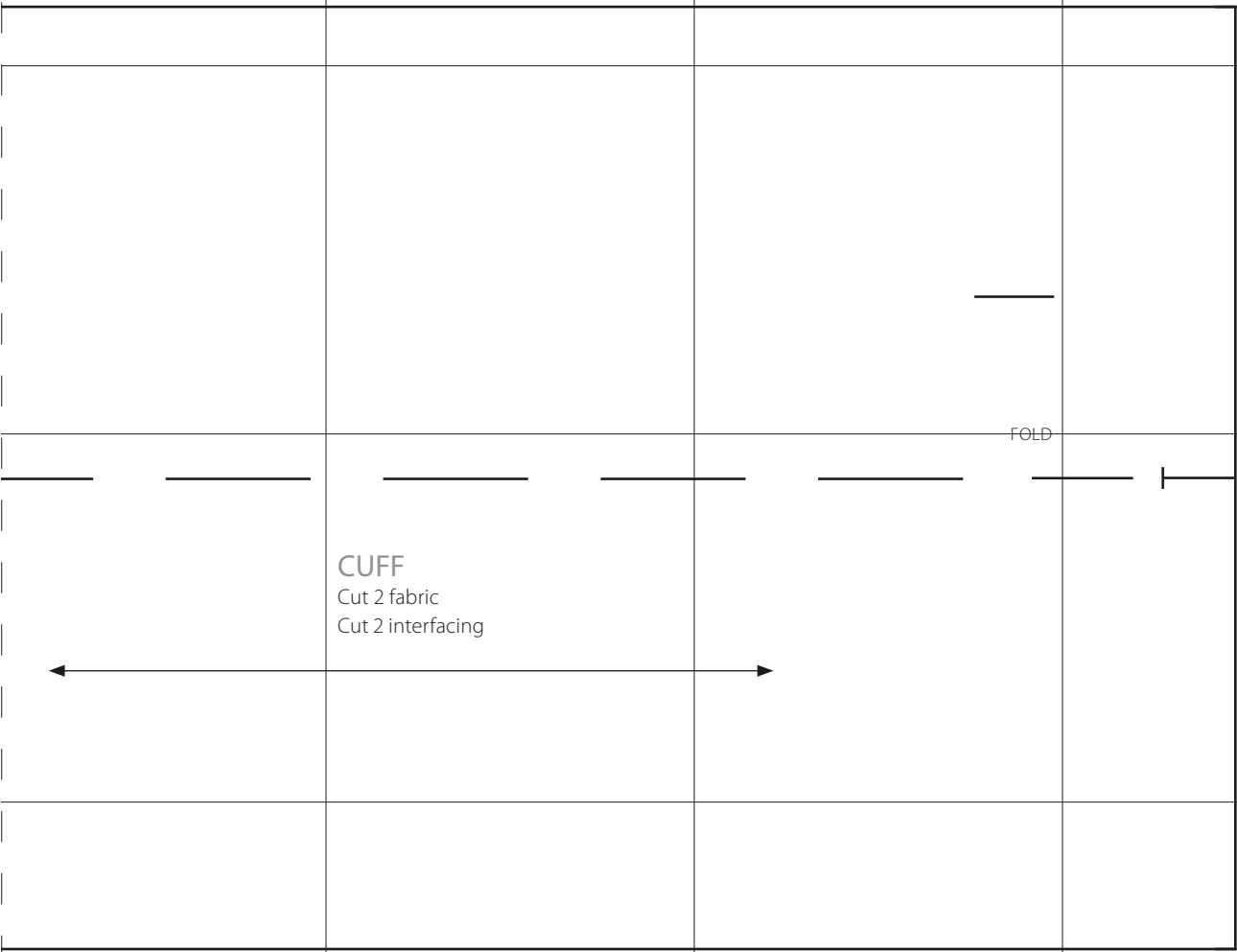

CUFF
 Cut 2 fabric
 Cut 2 interfacing

FOLD

E6

E6

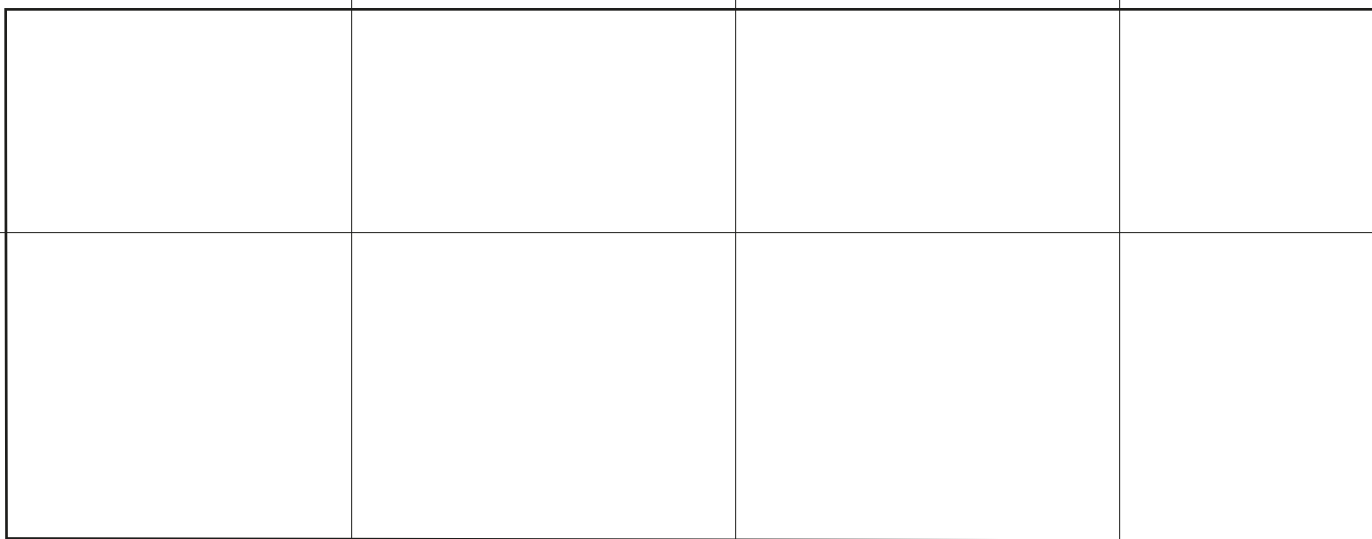

E6

E6

FRONT INTERFACING



Cut 2 interfacing

E8

E8

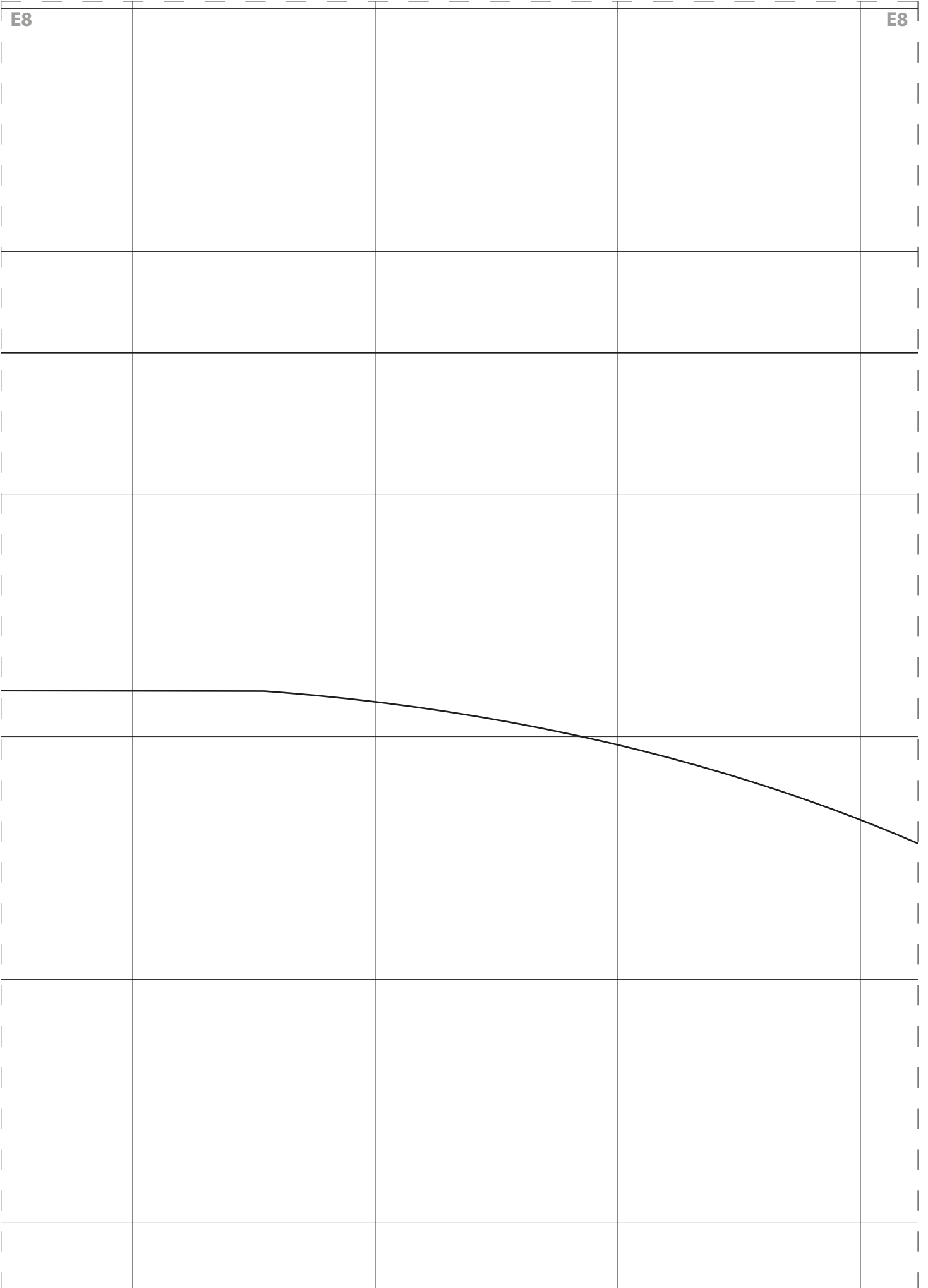

E8

E8

