

A1

A1

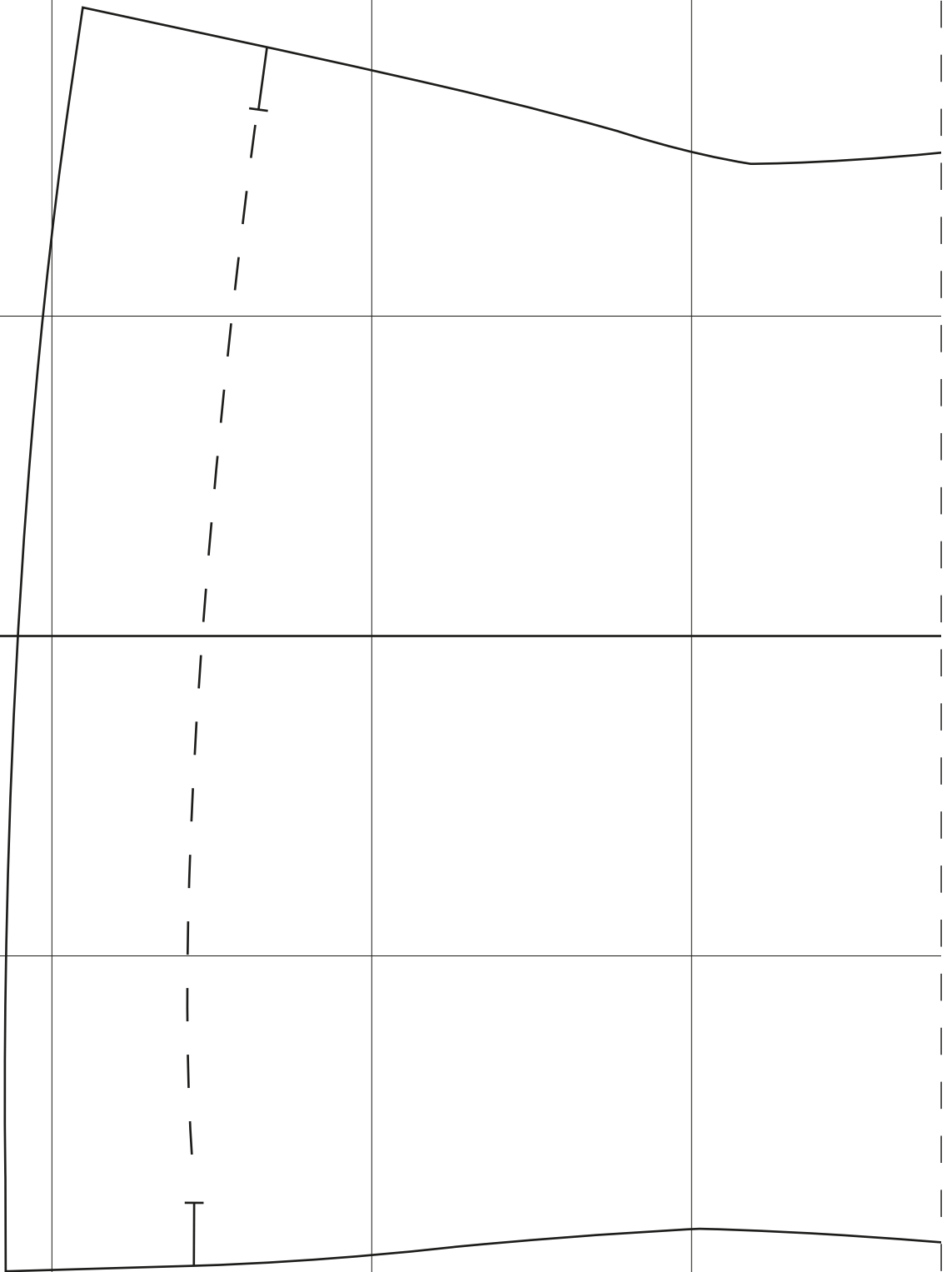

A1

A1

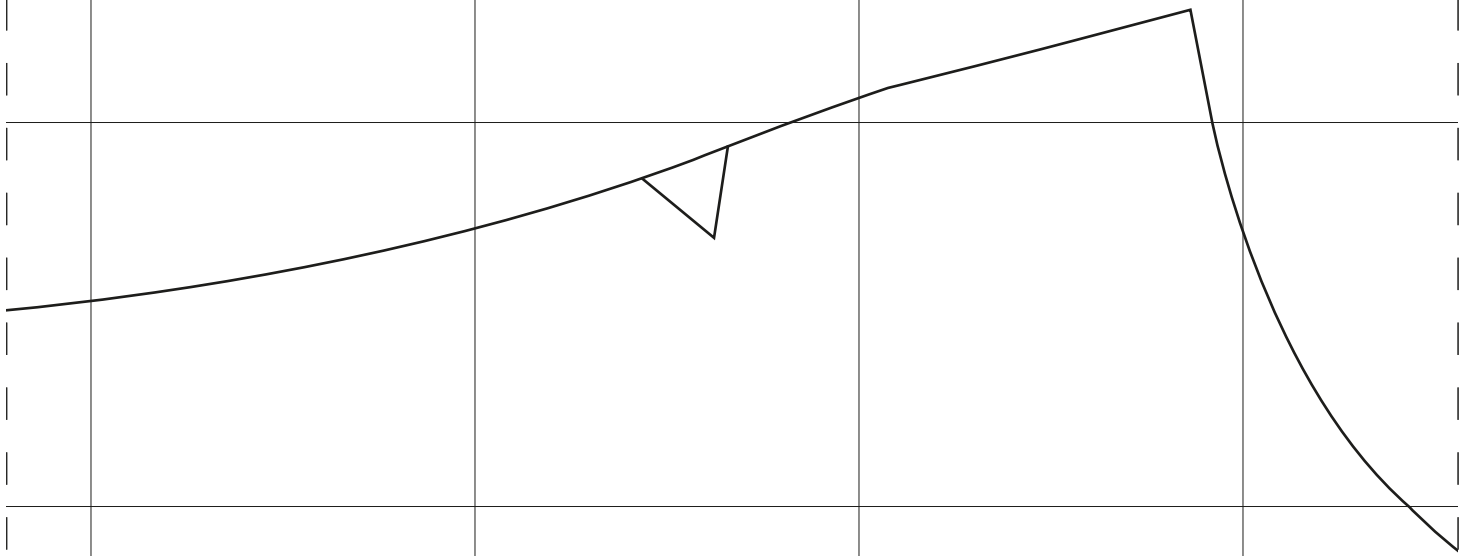

SIDE FRONT  
Cut 2 fabric

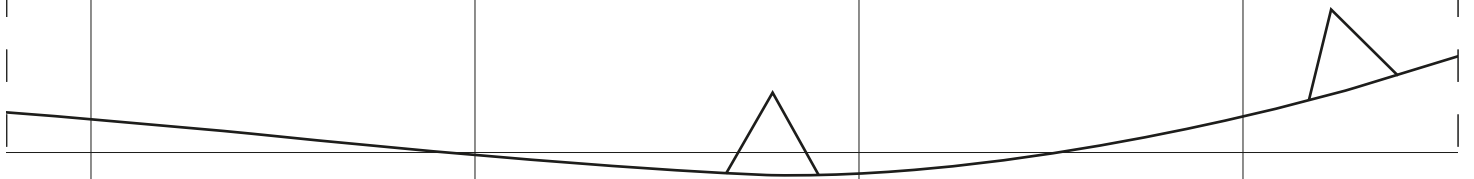

A3

A3

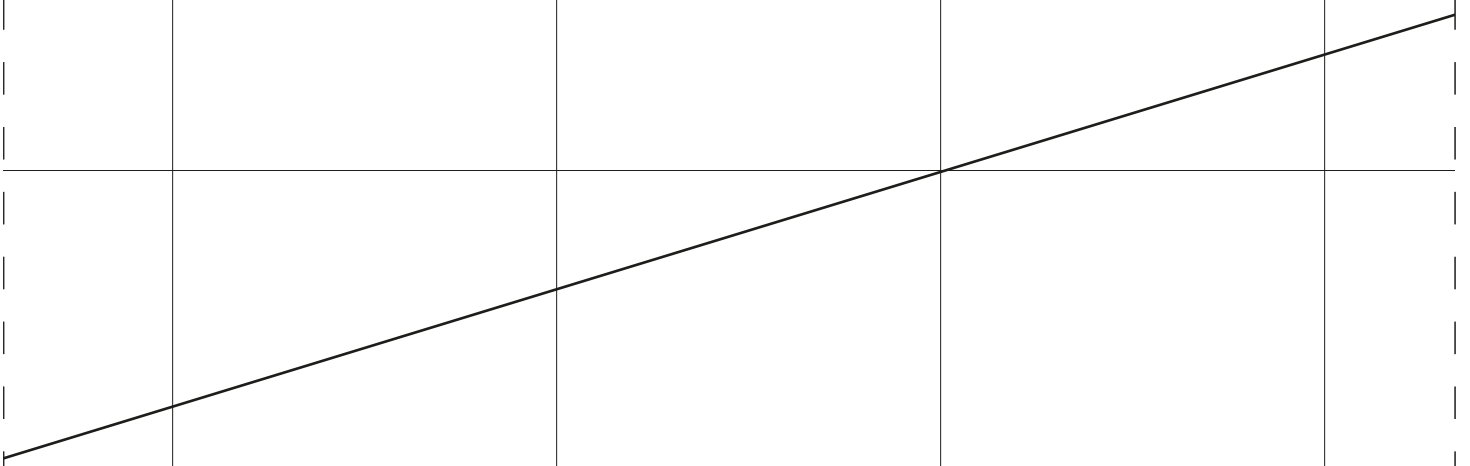
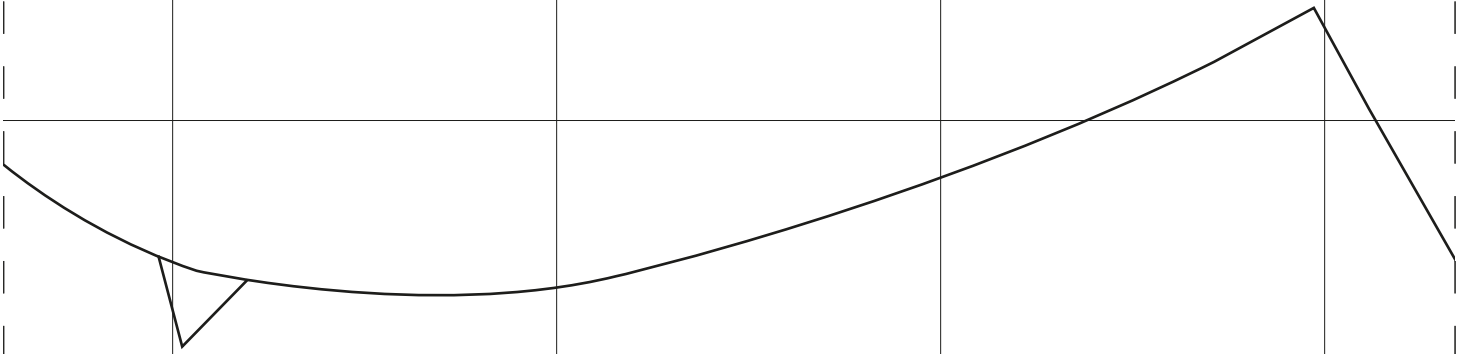

A3

A3

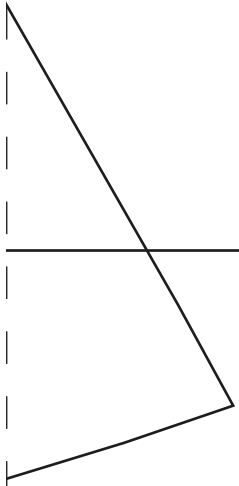

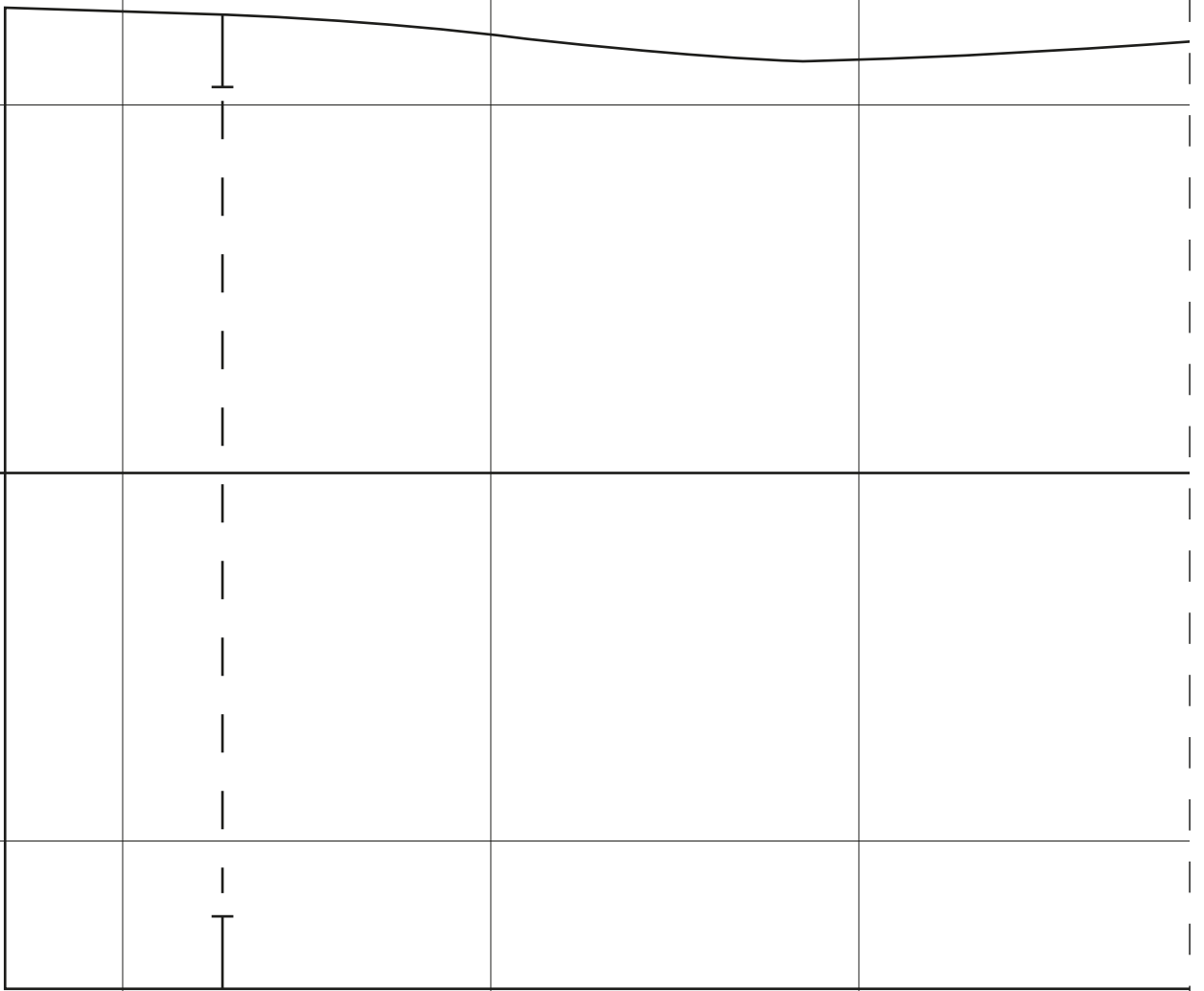

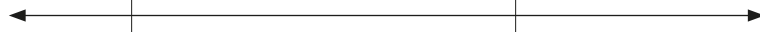
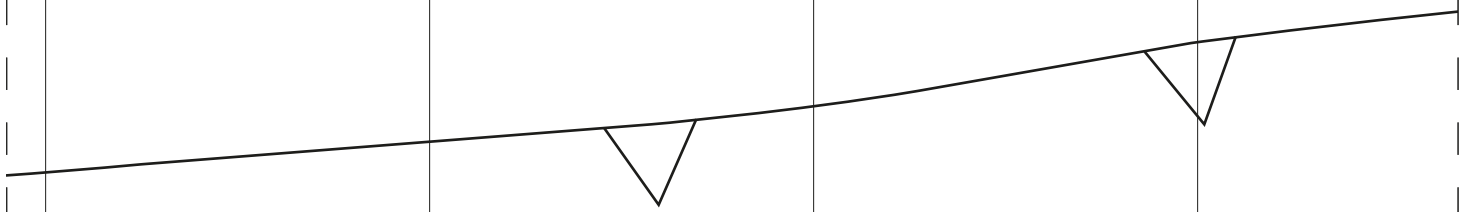

JACKET FRONT  
Cut 2 fabric

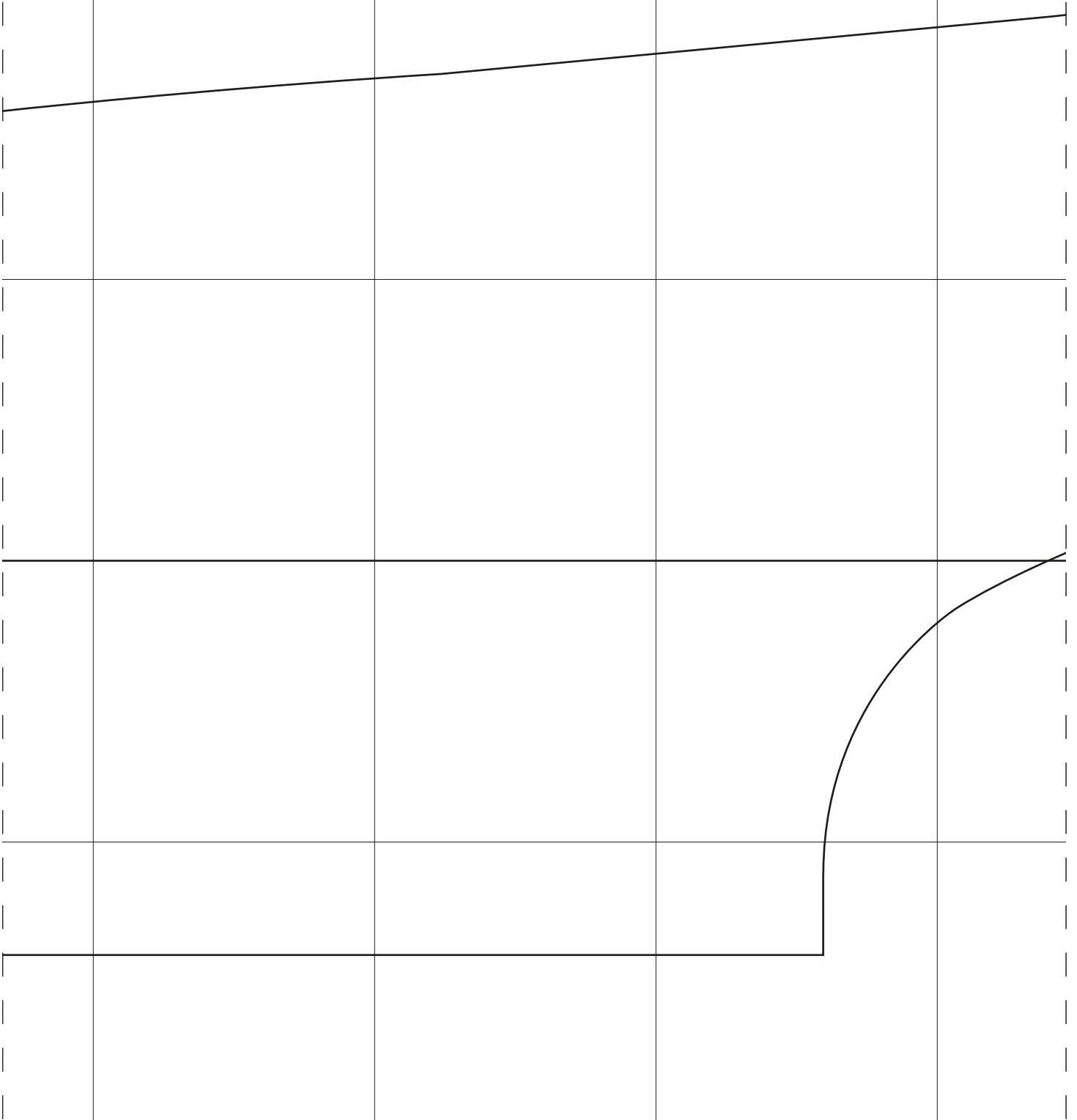

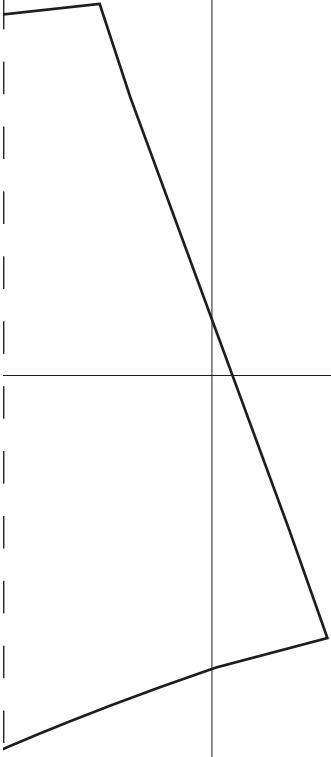



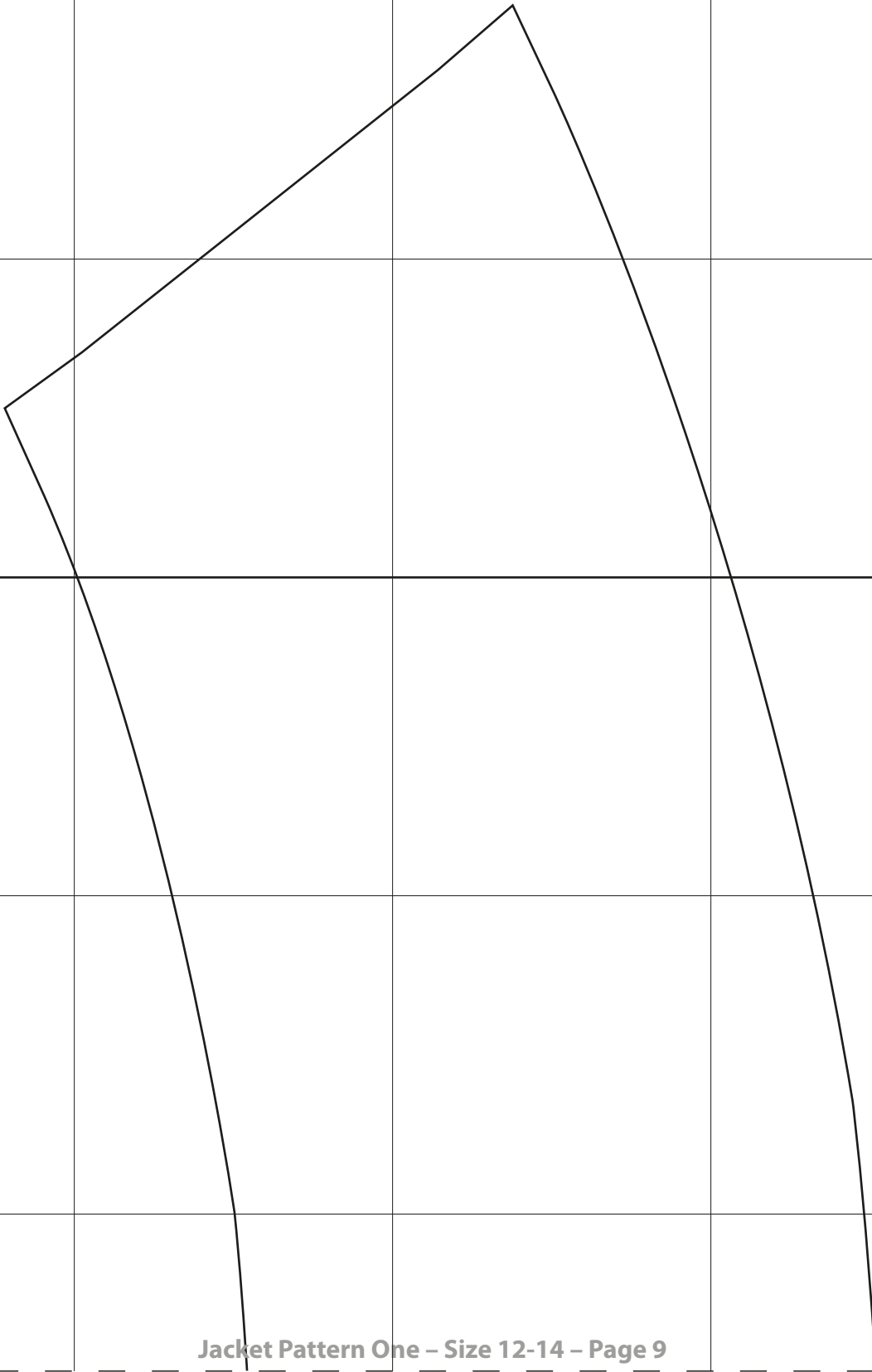

B1

B1

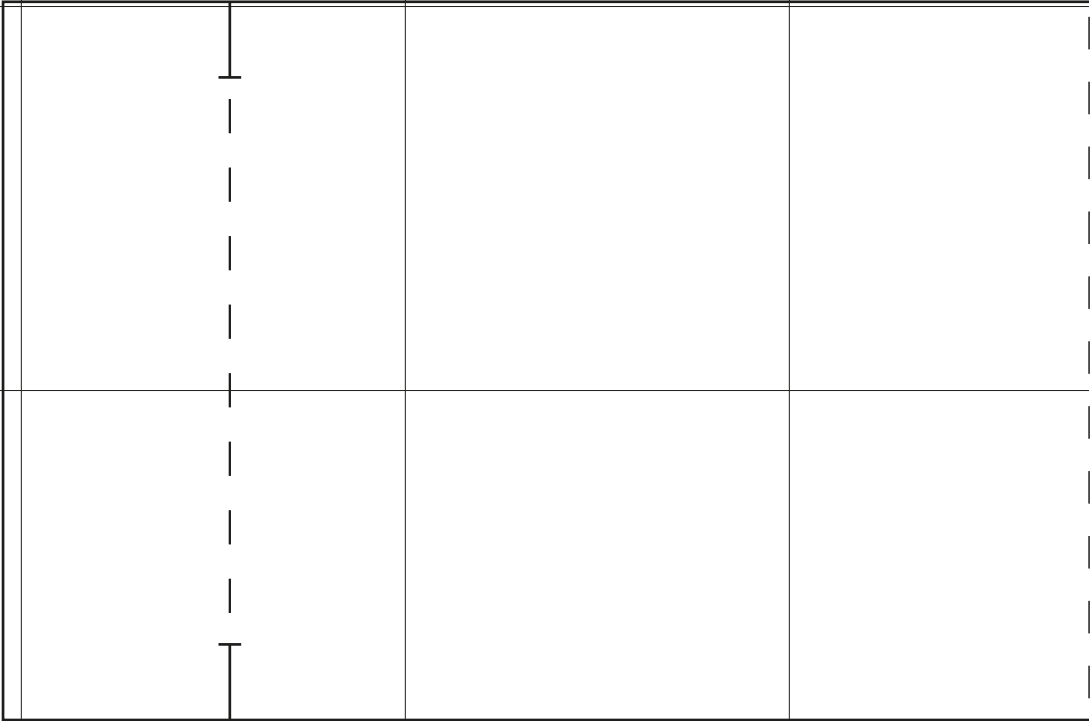

B1

B1

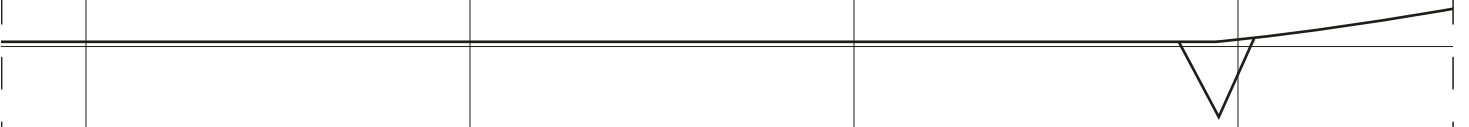

FRONT FACING  
Cut 2 fabric  
Cut 2 interfacing

B3

B3

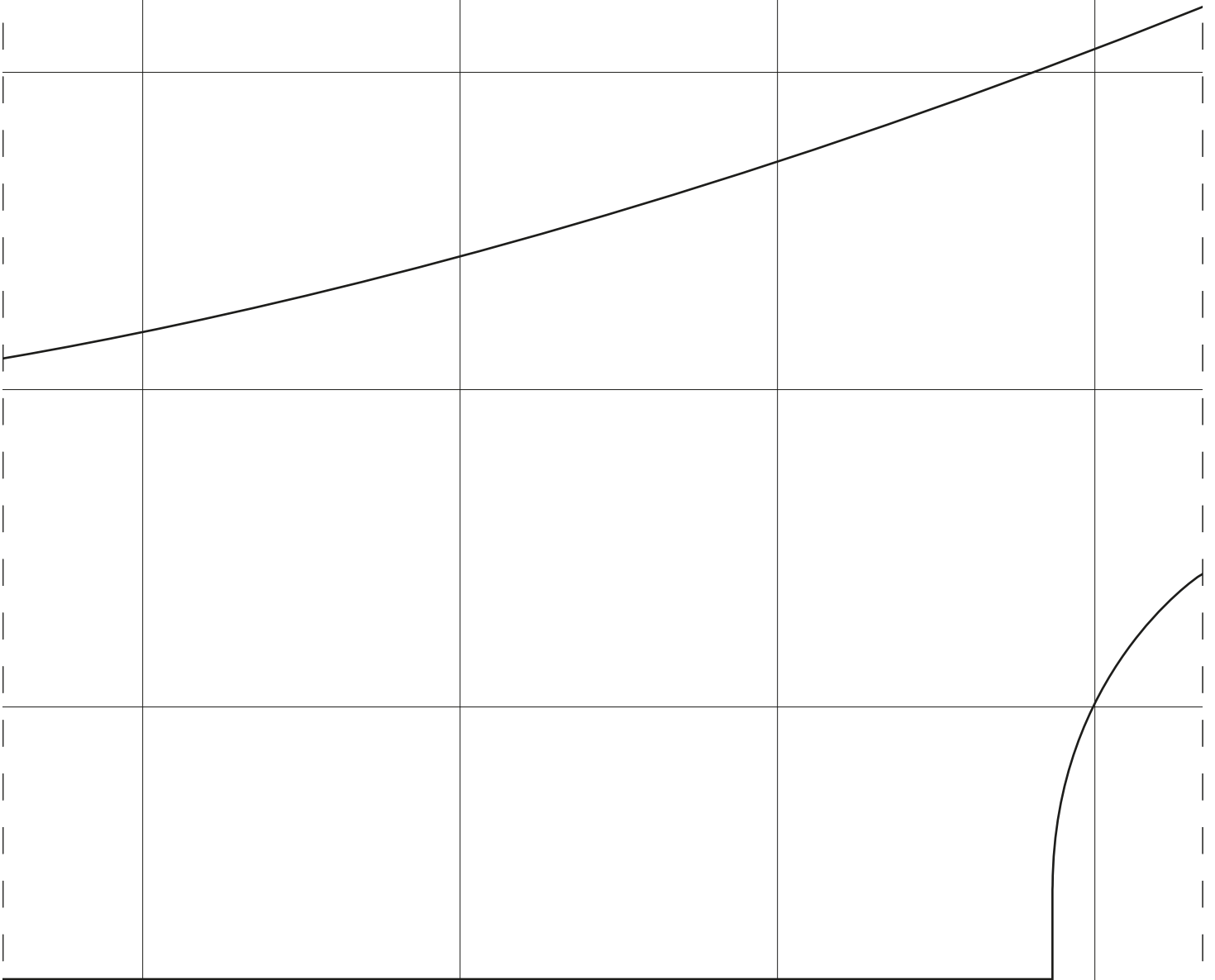

B3

B3

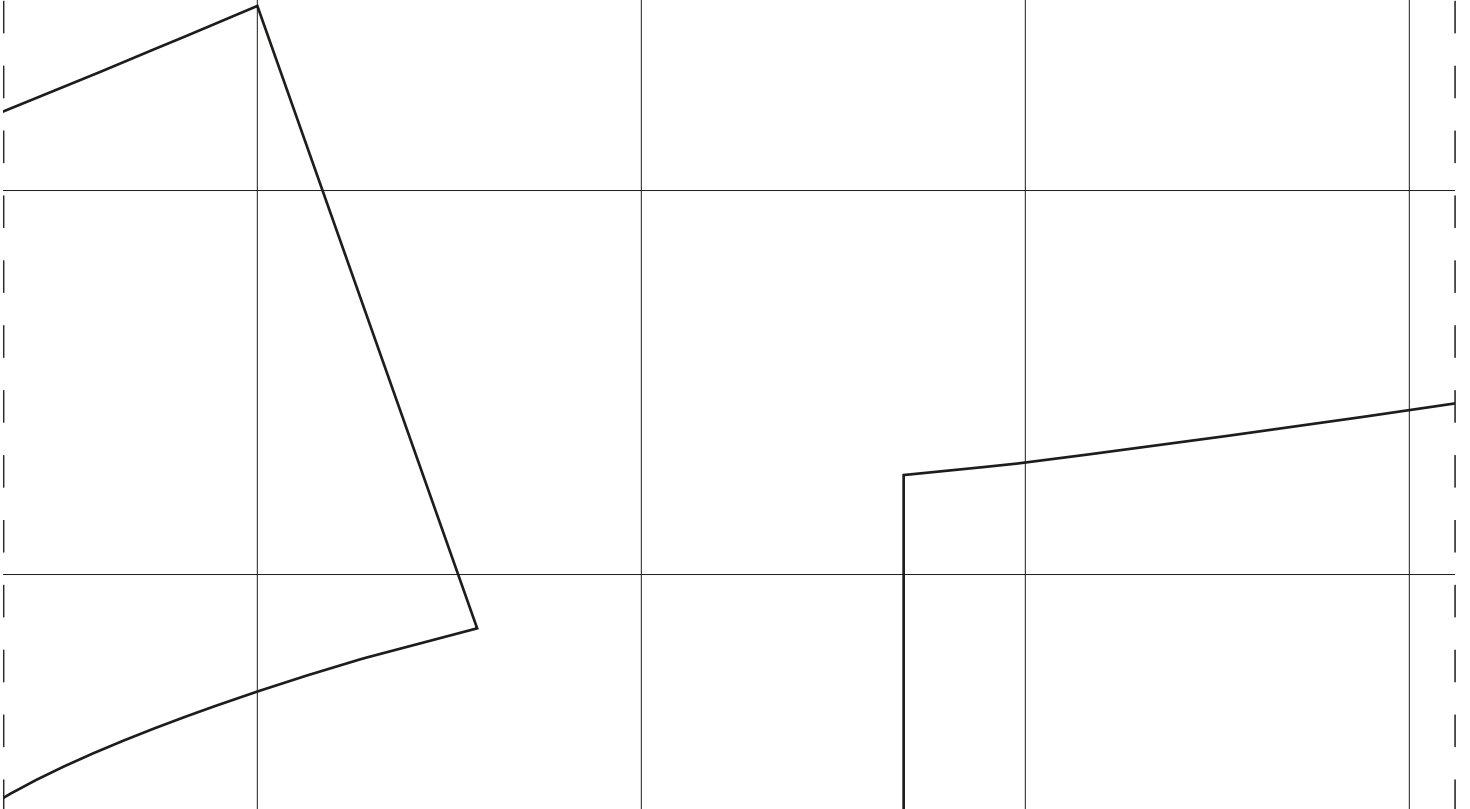

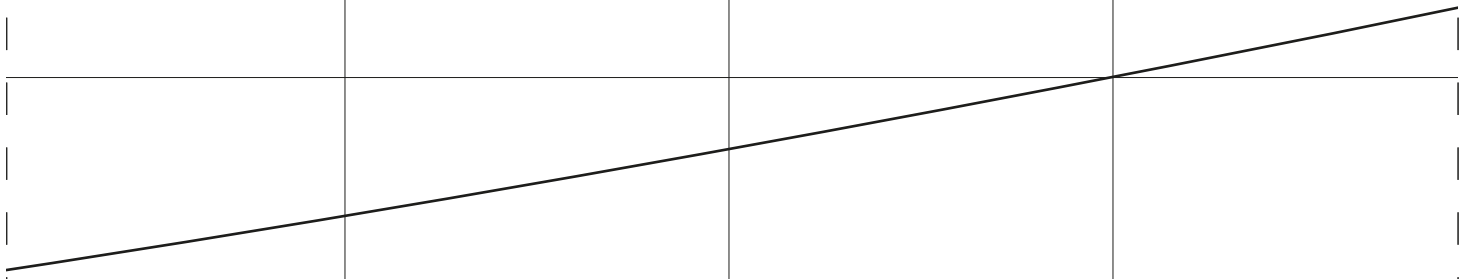

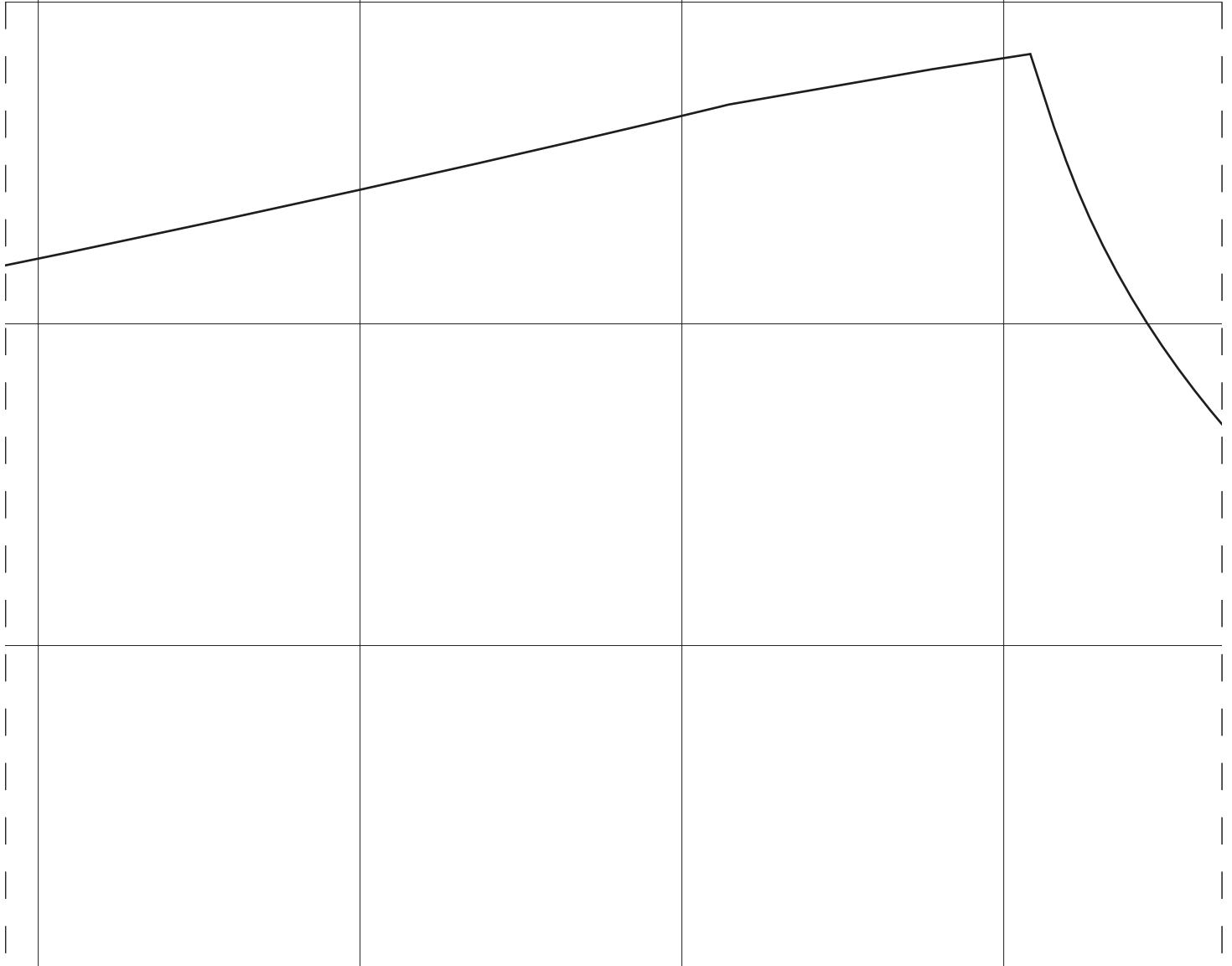

SLEEVE LINING  
(Variation only)  
Cut 2 lining

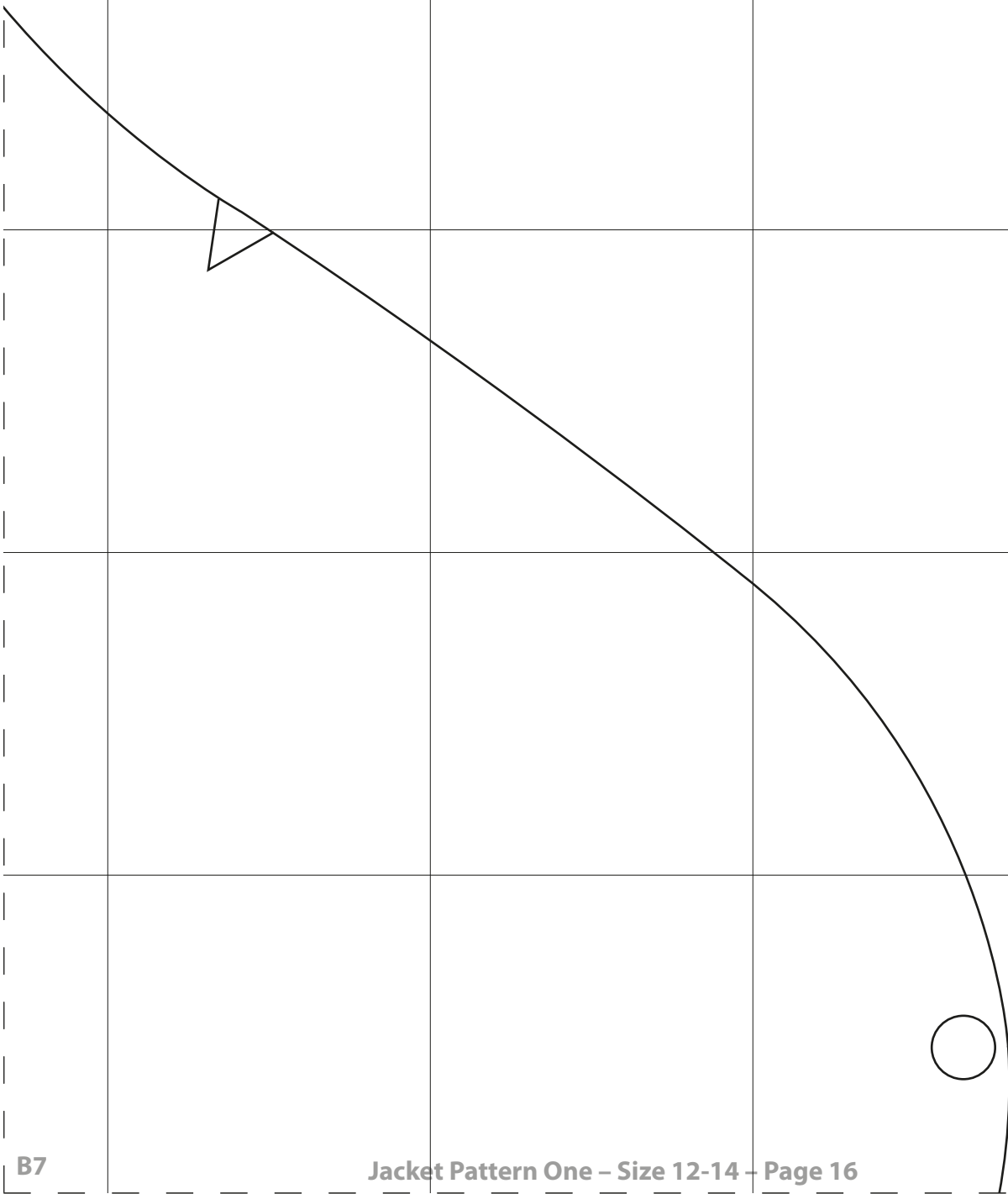



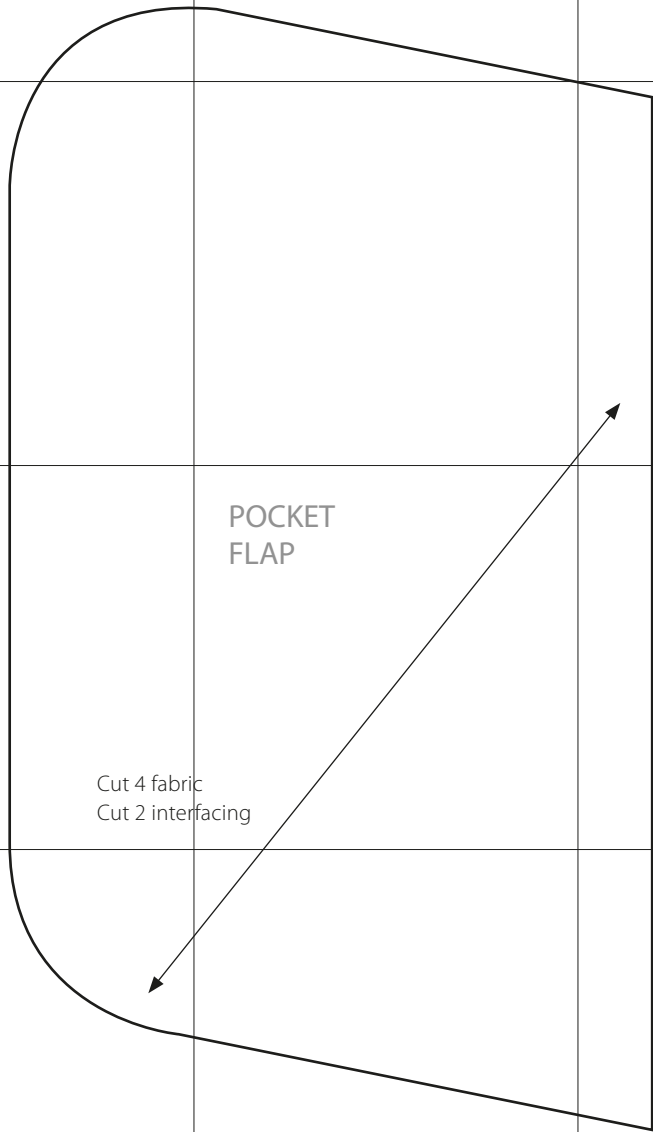

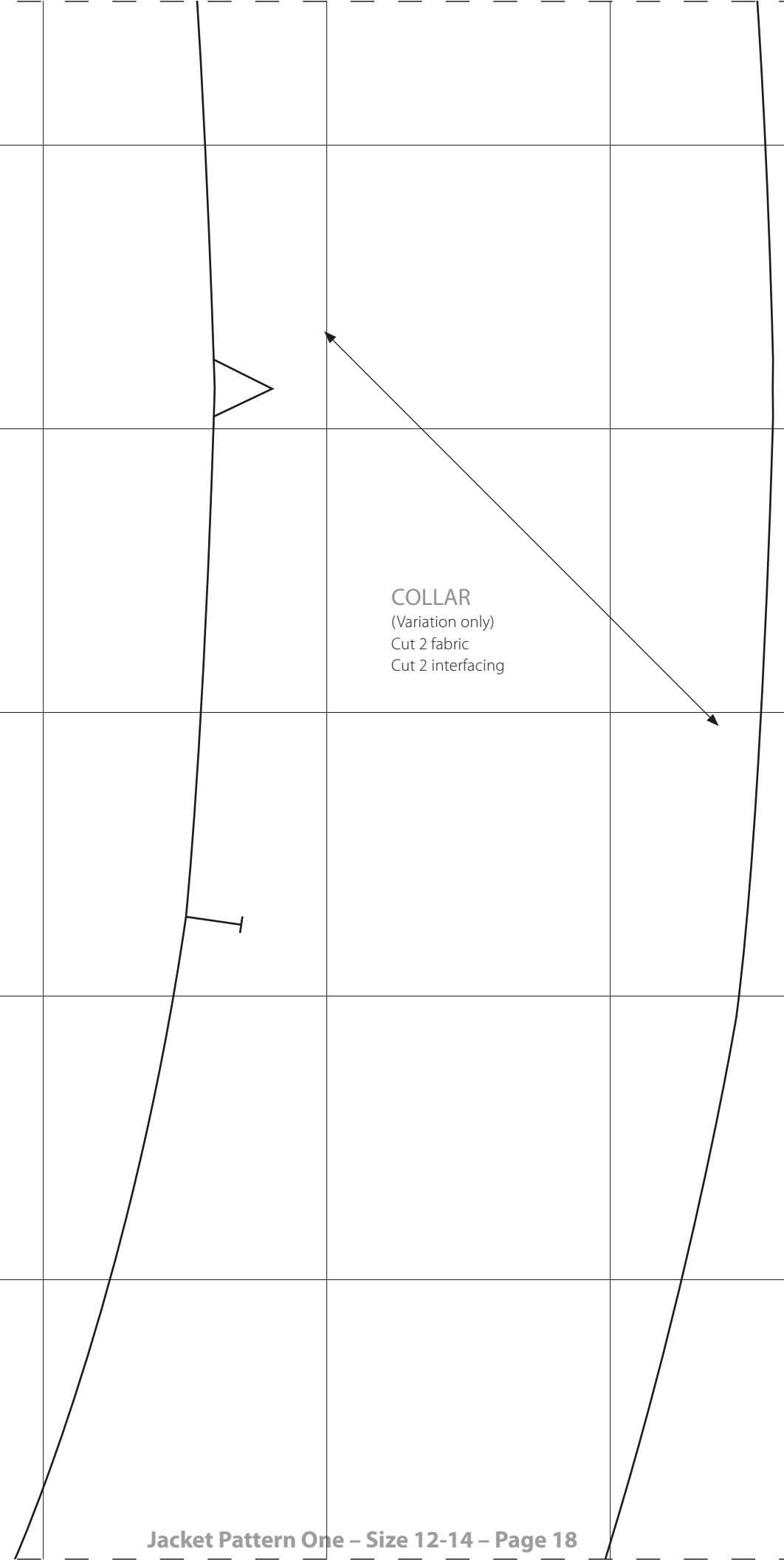

**COLLAR**  
(Variation only)  
Cut 2 fabric  
Cut 2 interfacing

C1

C1

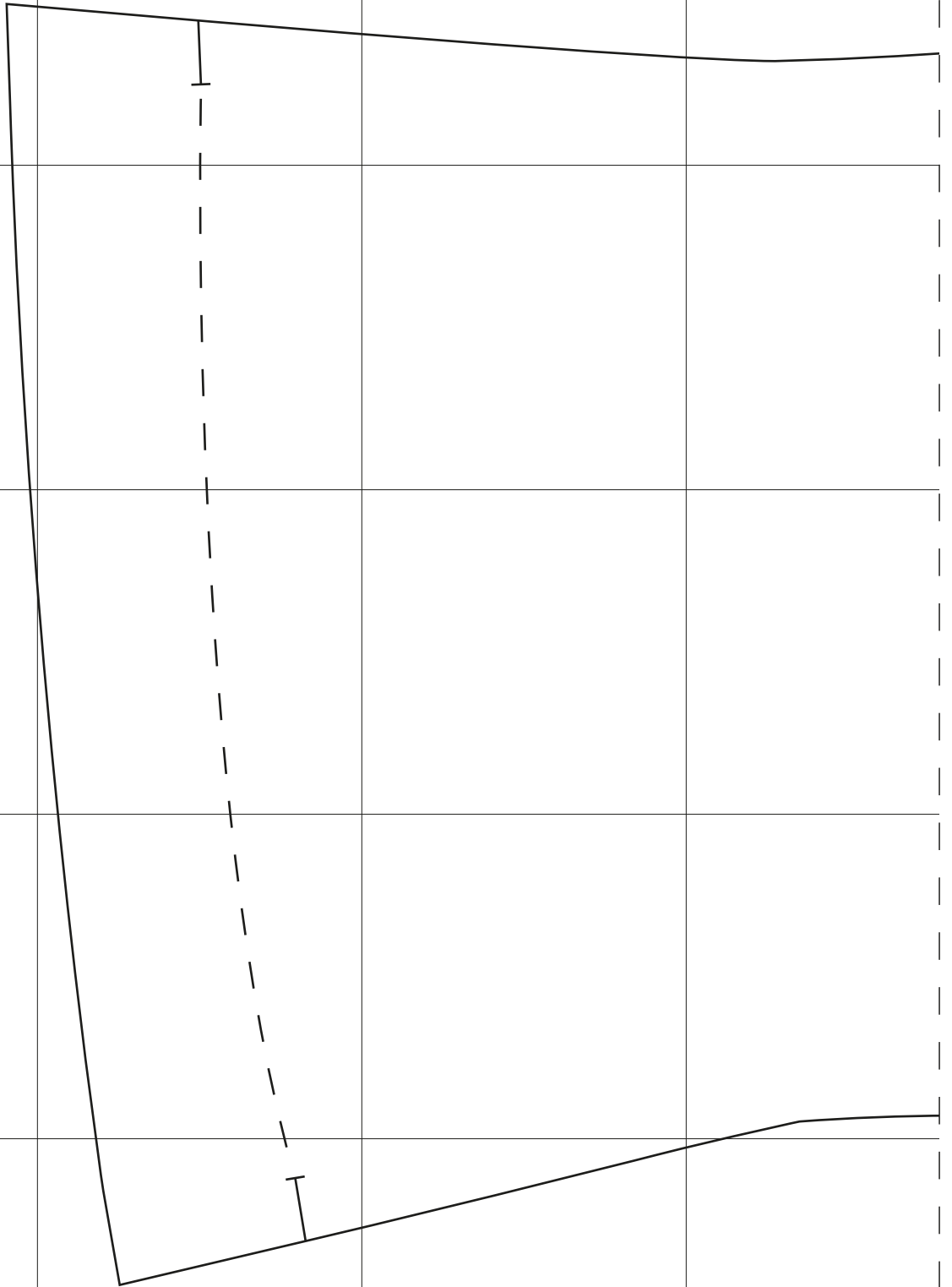

C1

C1

C2

C2



SIDE BACK  
Cut 2 fabric

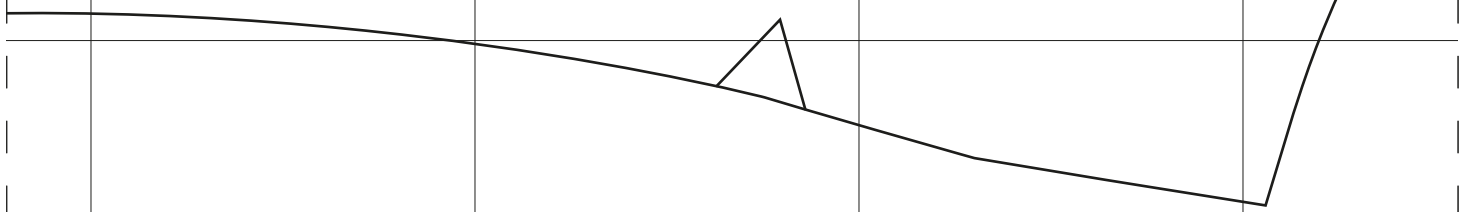

C2

C2

C3

C3

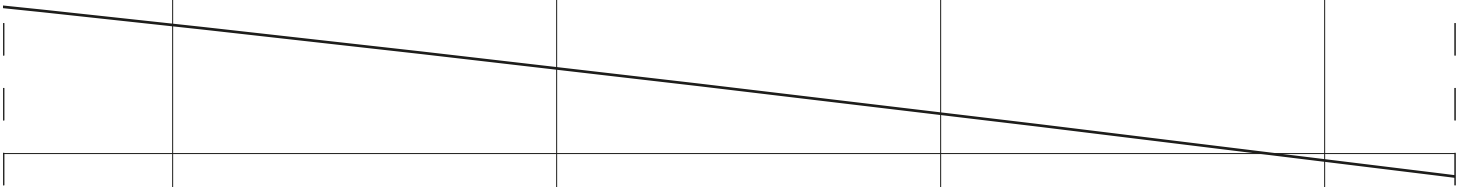

C3

C3

C4

C4

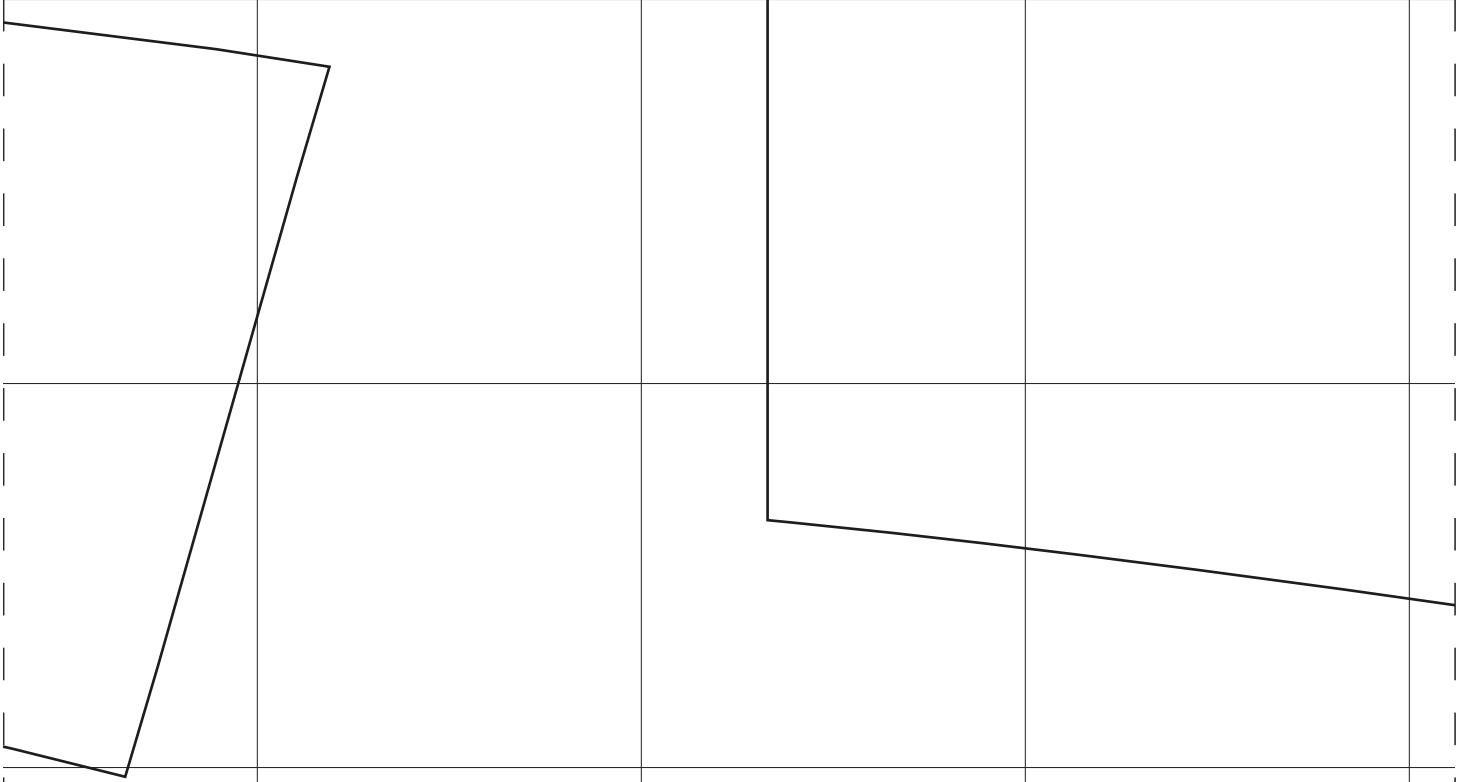

C4

C4

C5

C5

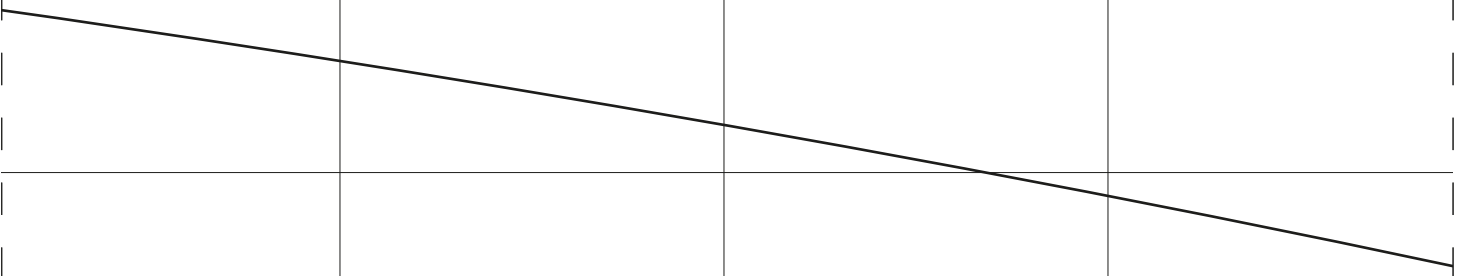

C5

C5

C6

C6

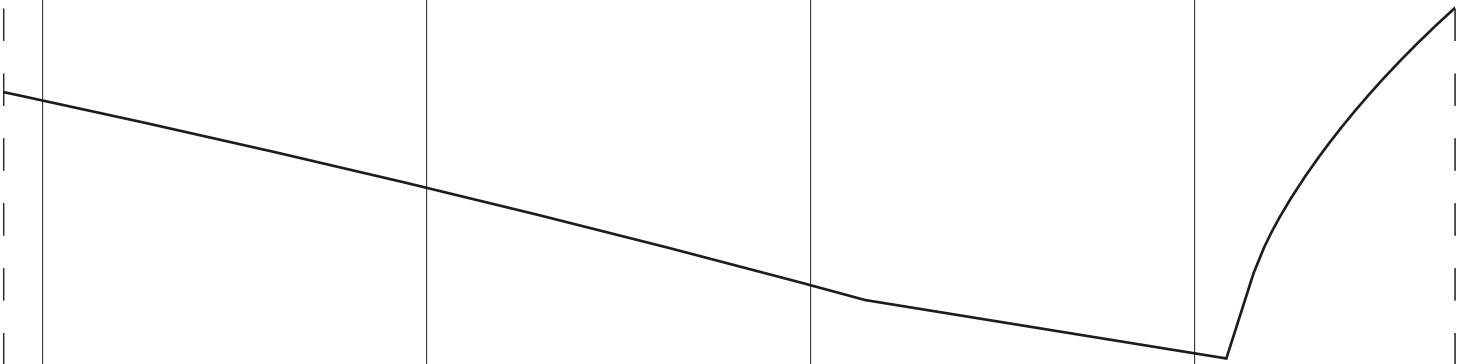

C6

C6



C7

C7

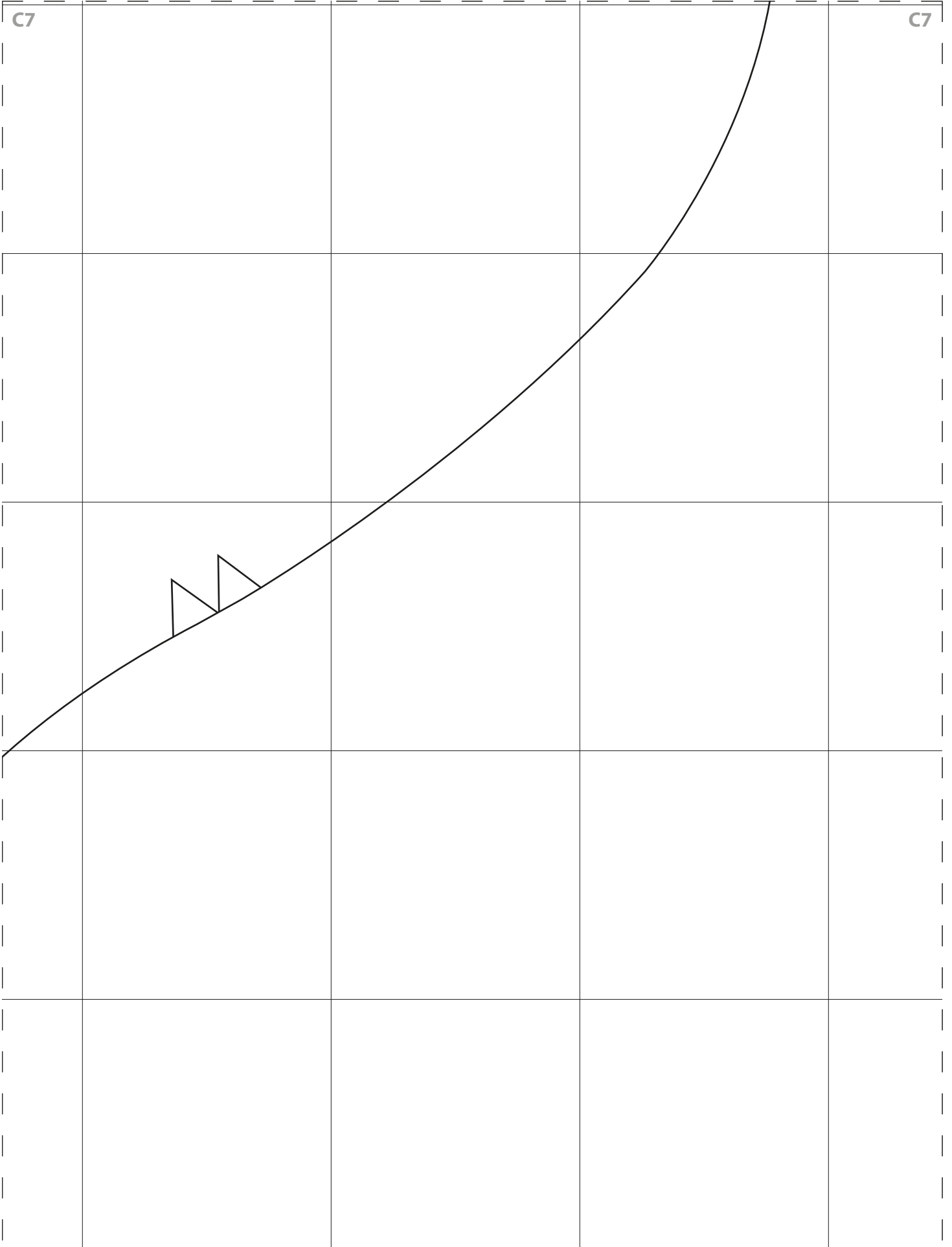

C7

C7

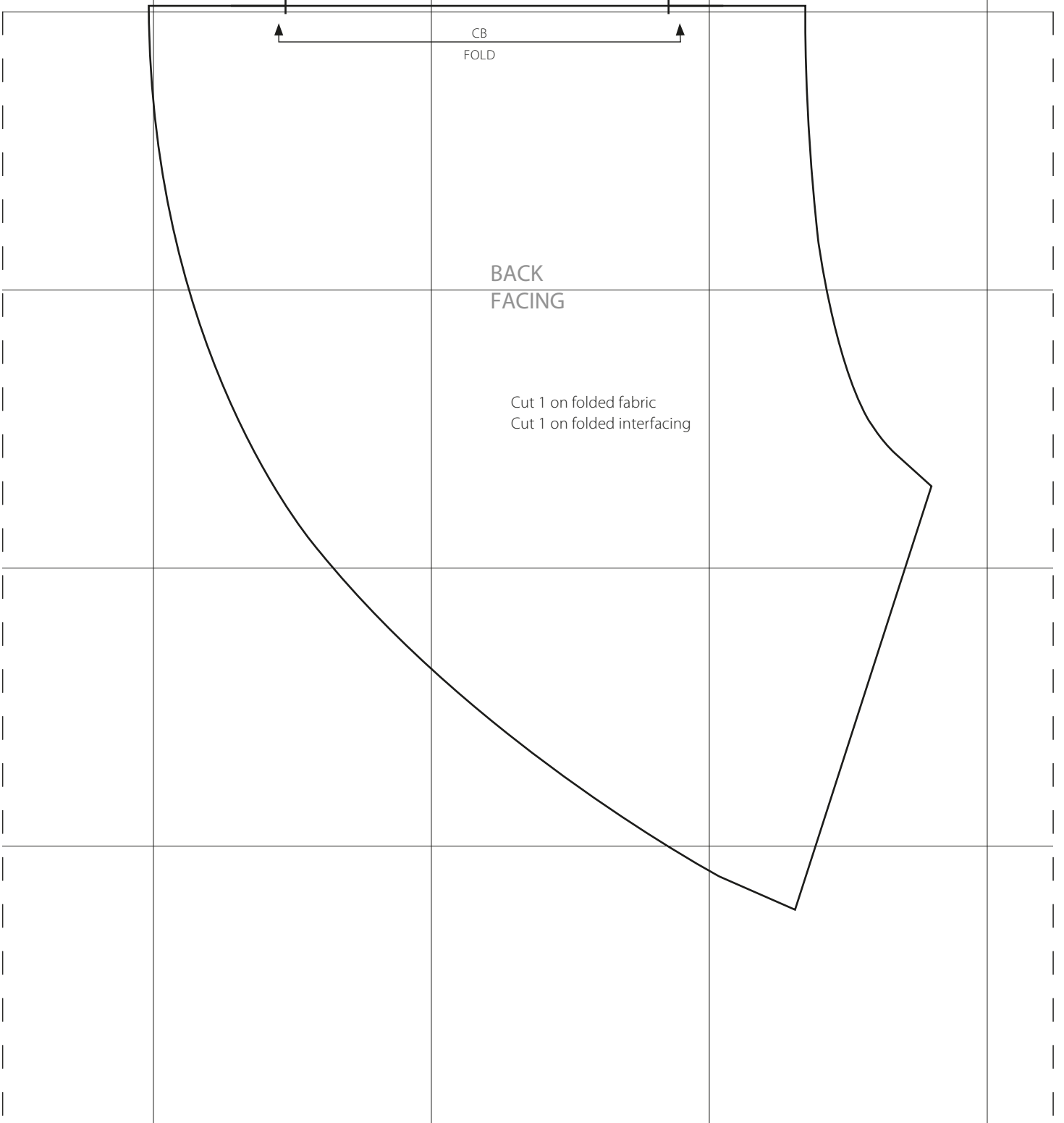

C9

C9

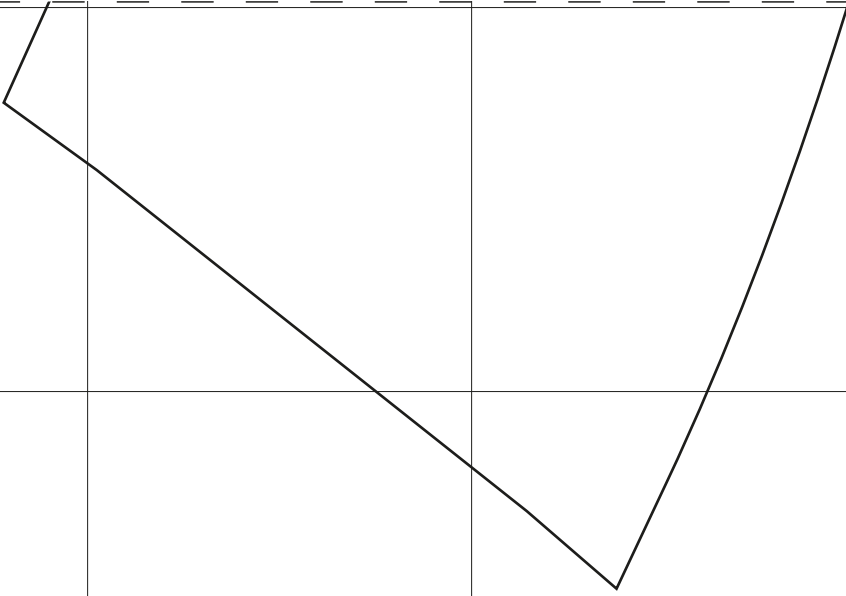

C9

C9

D1

D1

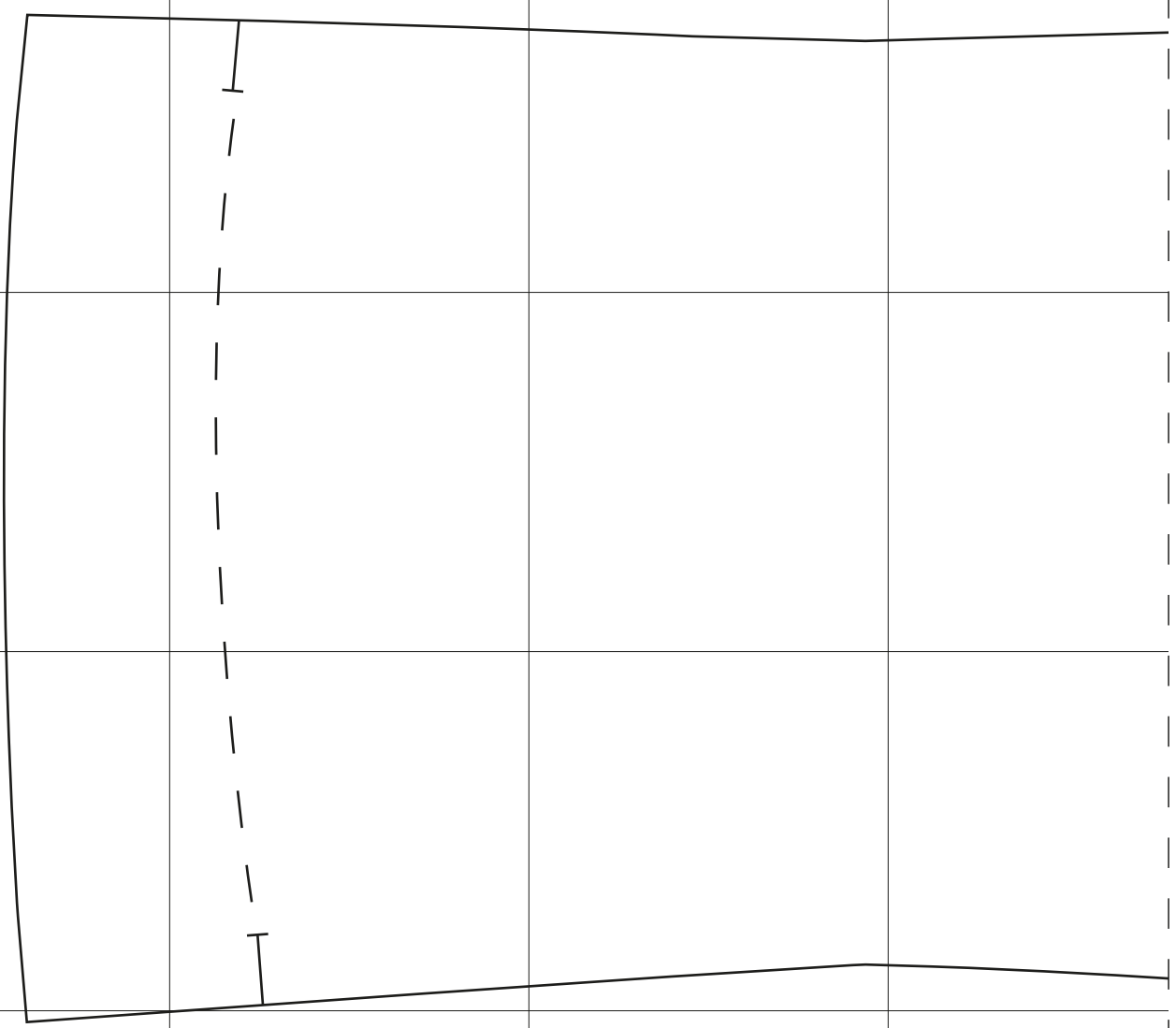

D1

D1

D2

D2



JACKET BACK  
Cut 2 fabric

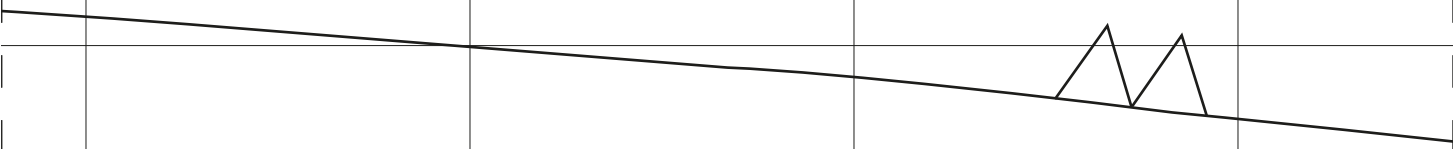

D2

D2

D3

D3



D3

D3



D5

D5

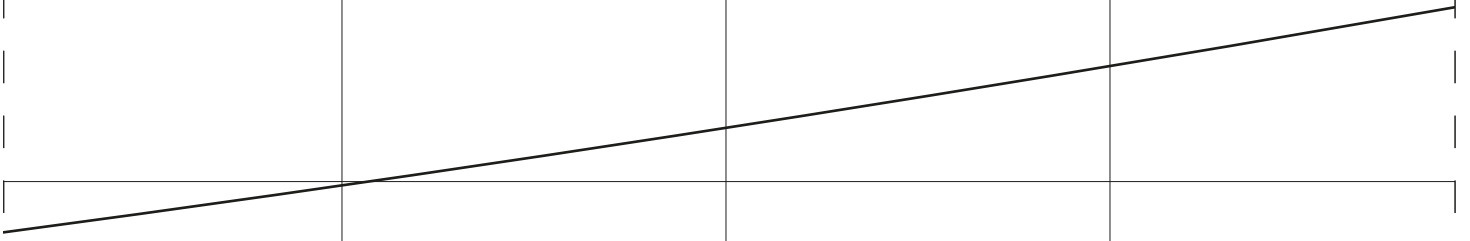

D5

D5



D6

D6

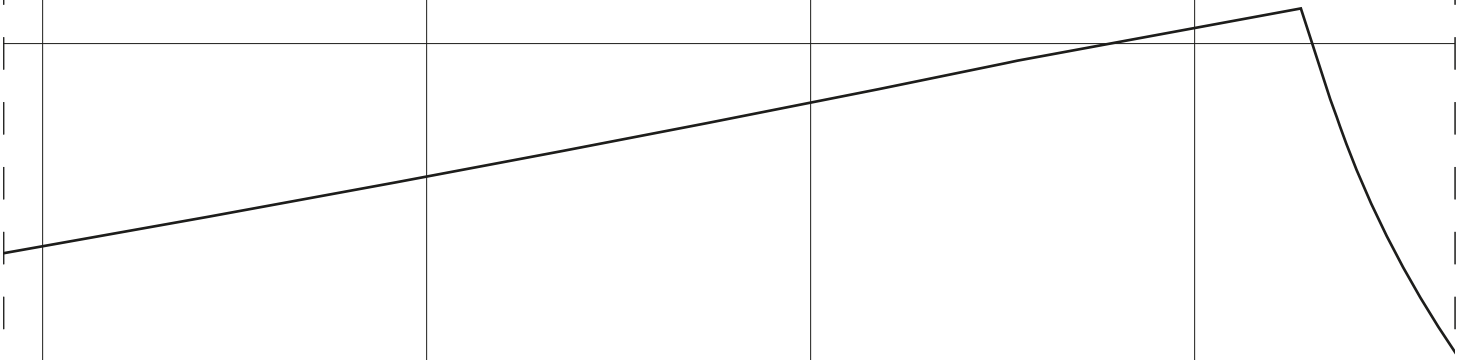

SLEEVE  
Cut 2 fabric

D6

D6

D7

D7

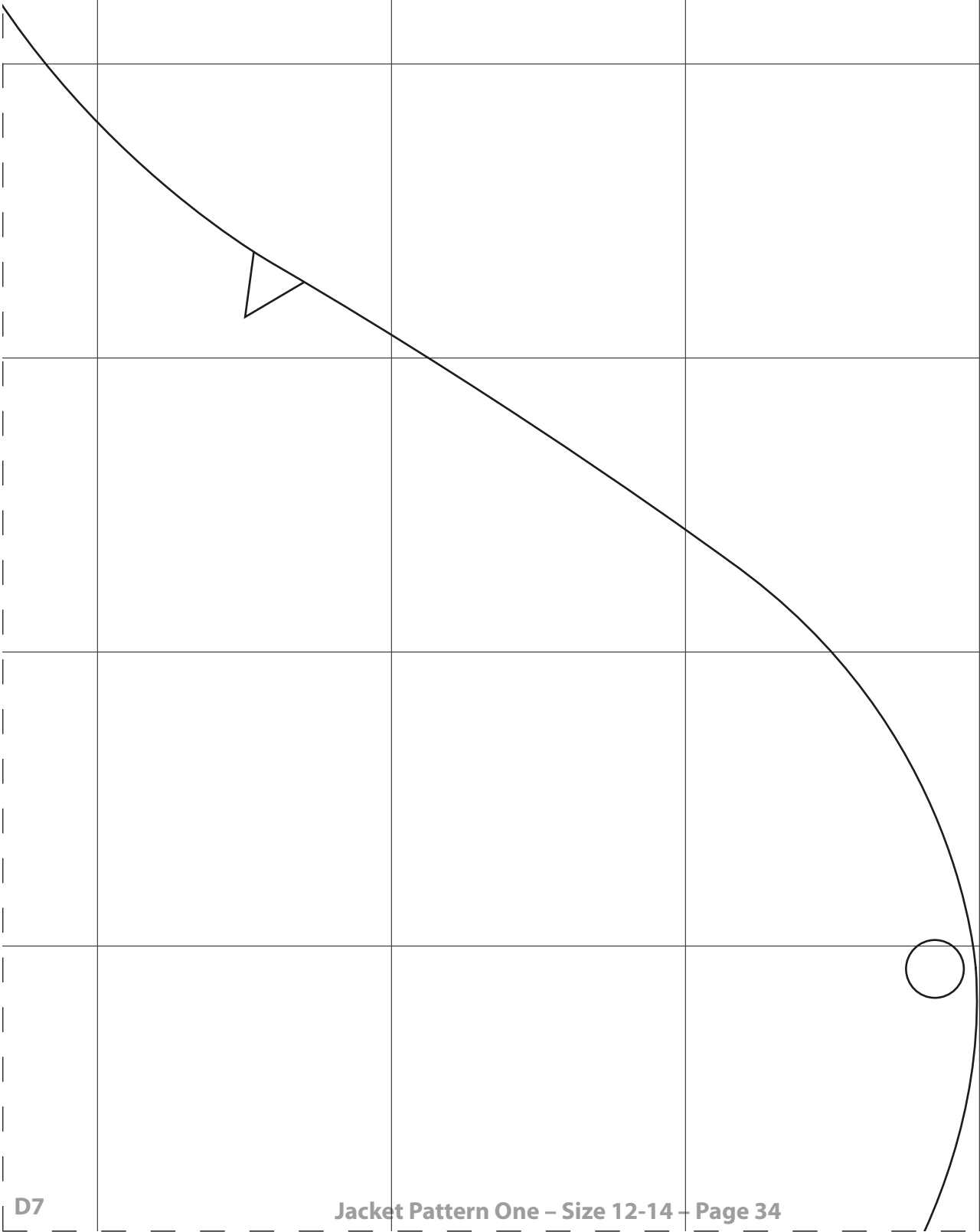

D7

D7

E1

E1

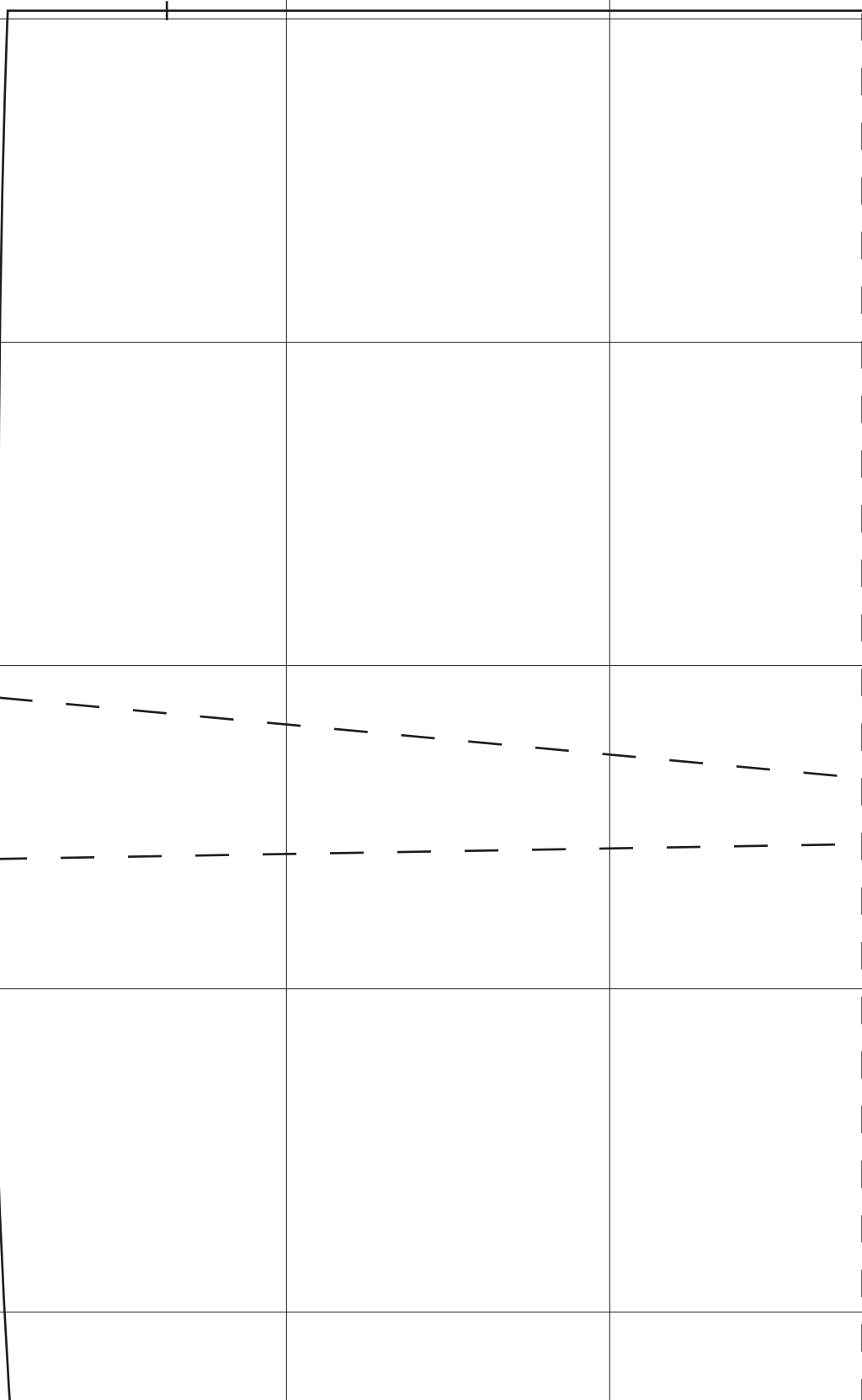

E1

E1



BACK LINING  
(Variation only)  
Cut 1 on folded lining

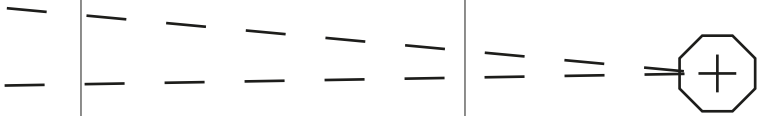

TUCK



E4

E4

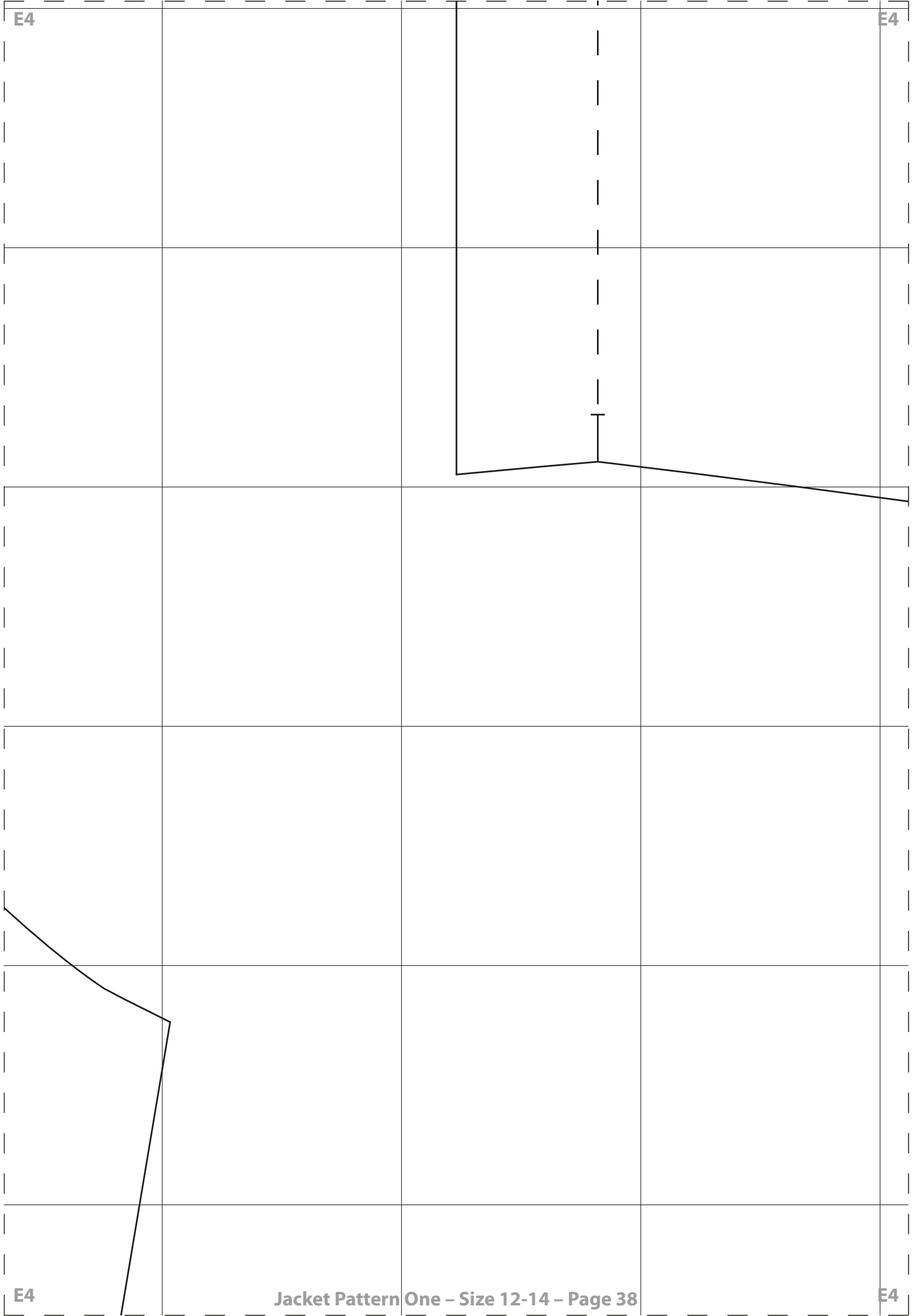

E4

E4

E5

E5

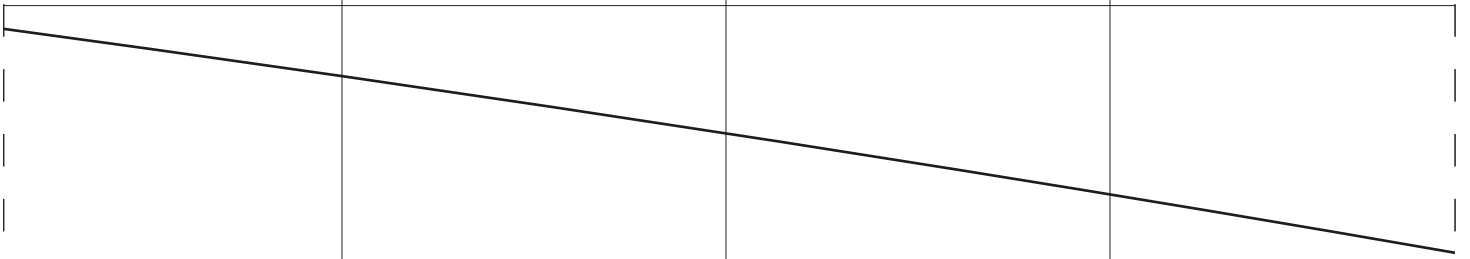

E5

E5

E6

E6

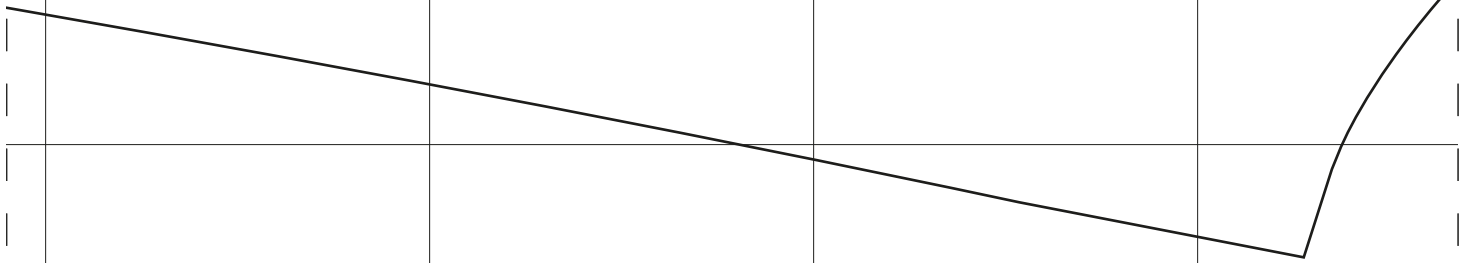

E6

E6



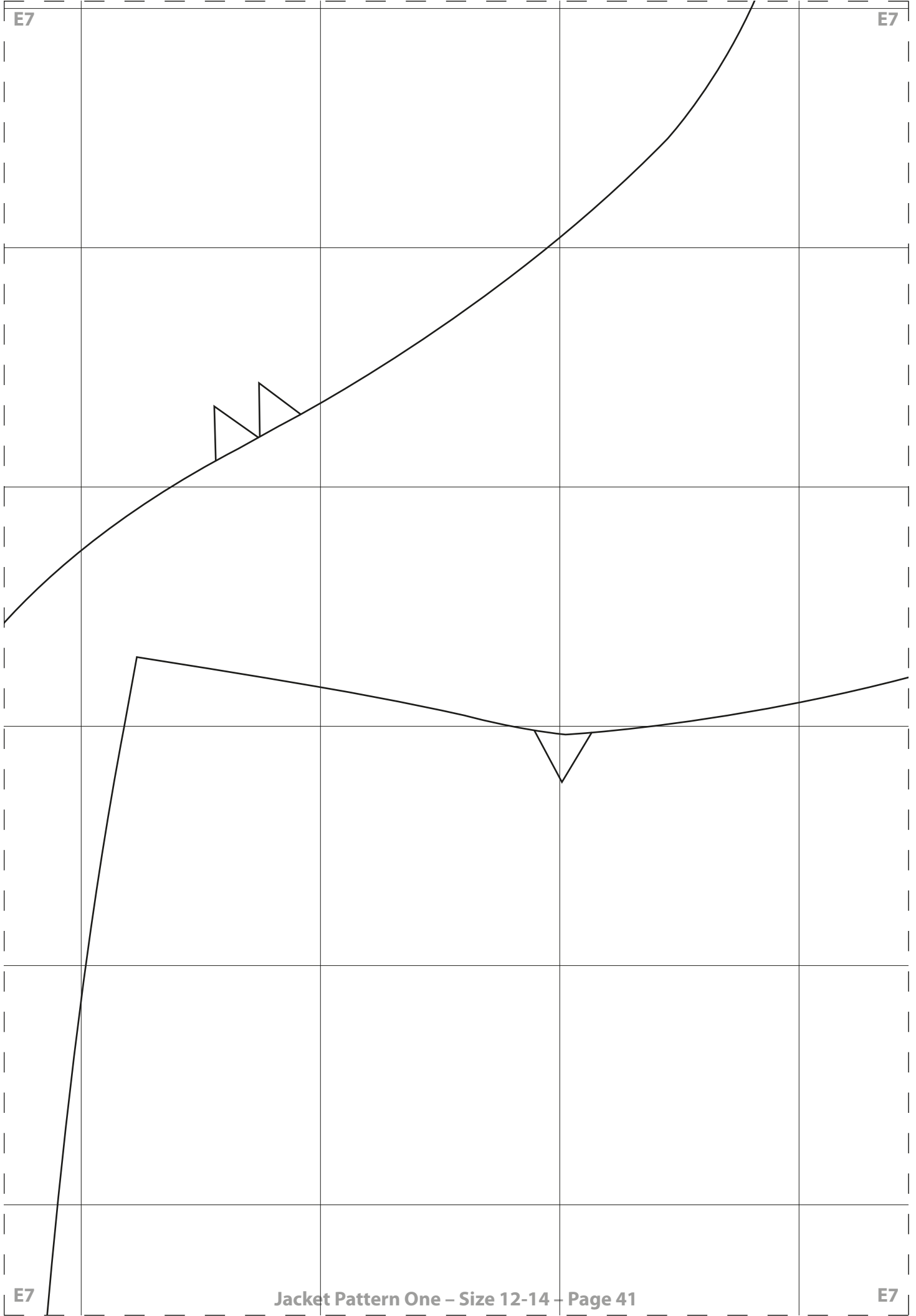

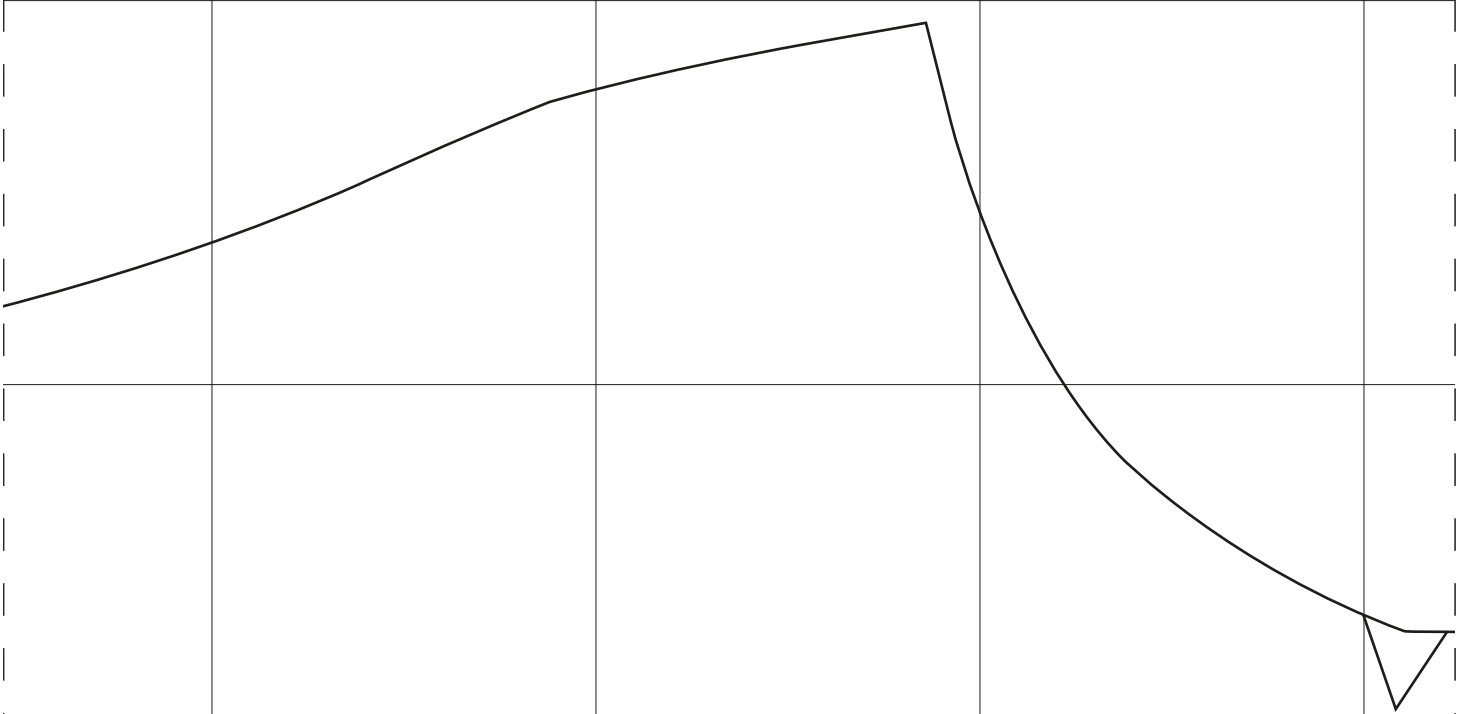

FRONT LINING  
(Variation only)  
Cut 2 lining

E9

E9

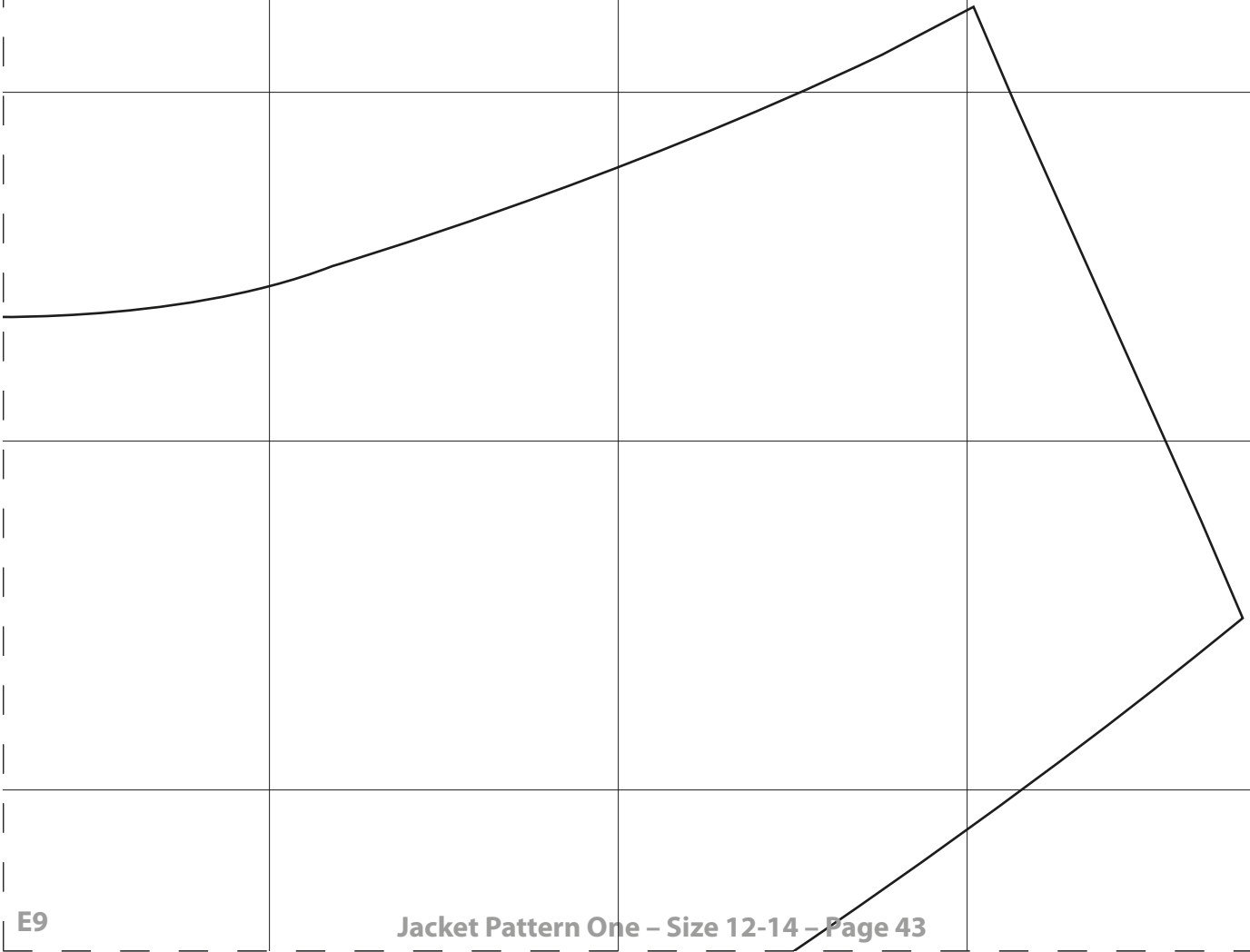

E9

E9

F1

F1

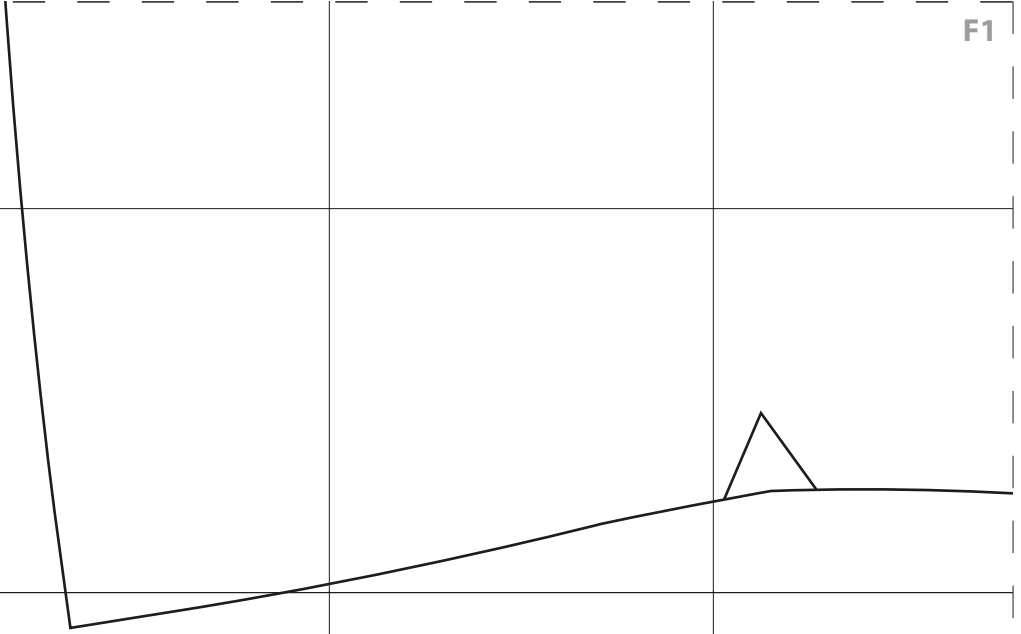

F1

F1

F2

F2

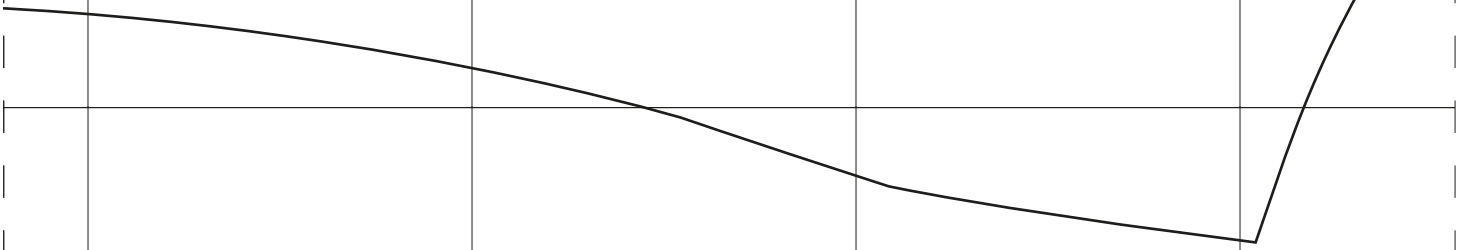

F2

F2

F3

F3

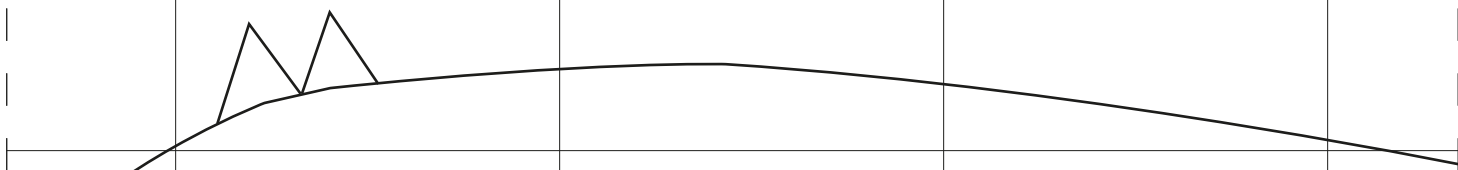

F3

F3

F4

F4

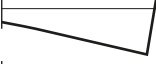

F4

F4





F6

F6

F6

F6

F7

F7

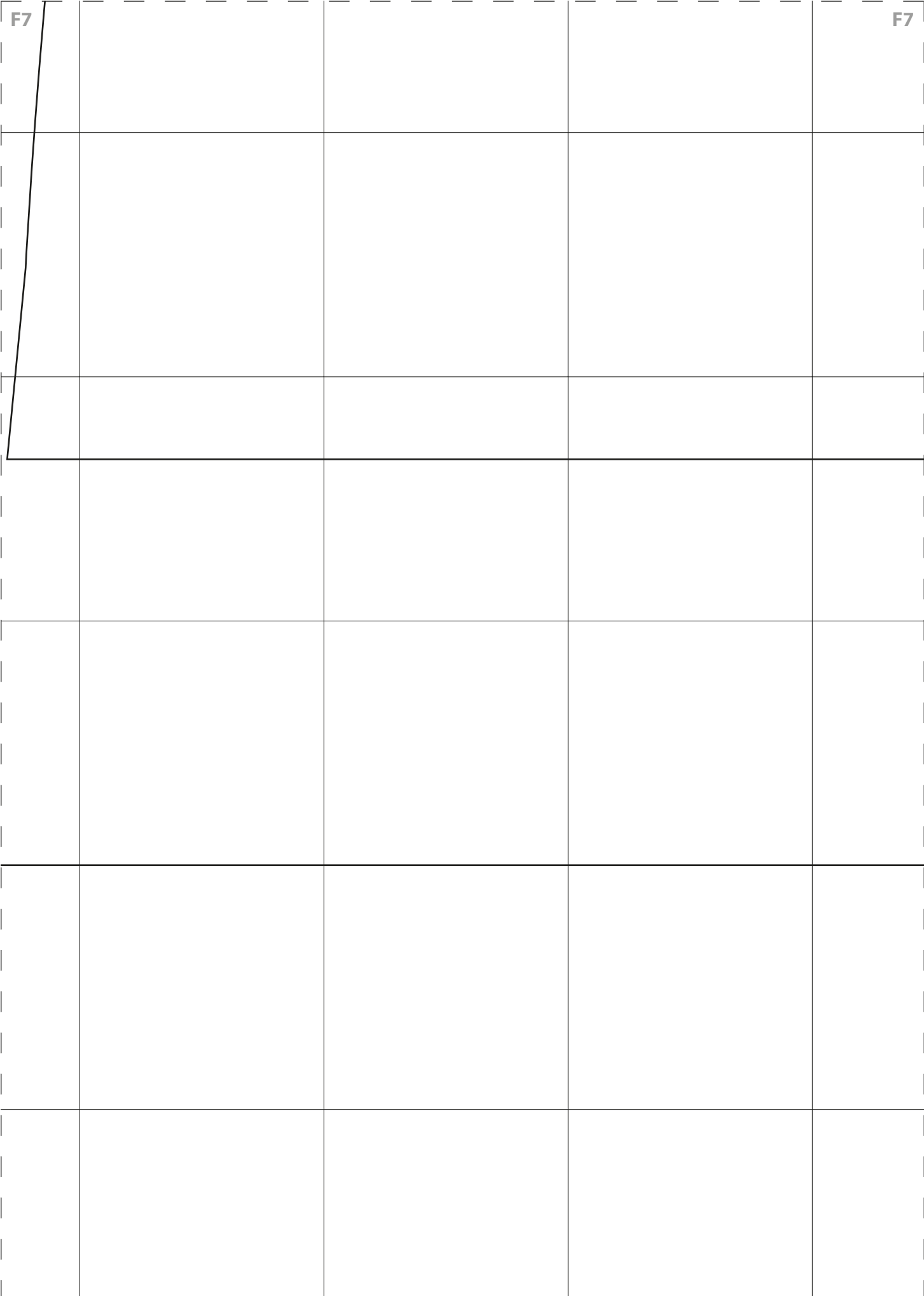

F7

F7

F8

F8

TUCK

F8

F8

F9

F9

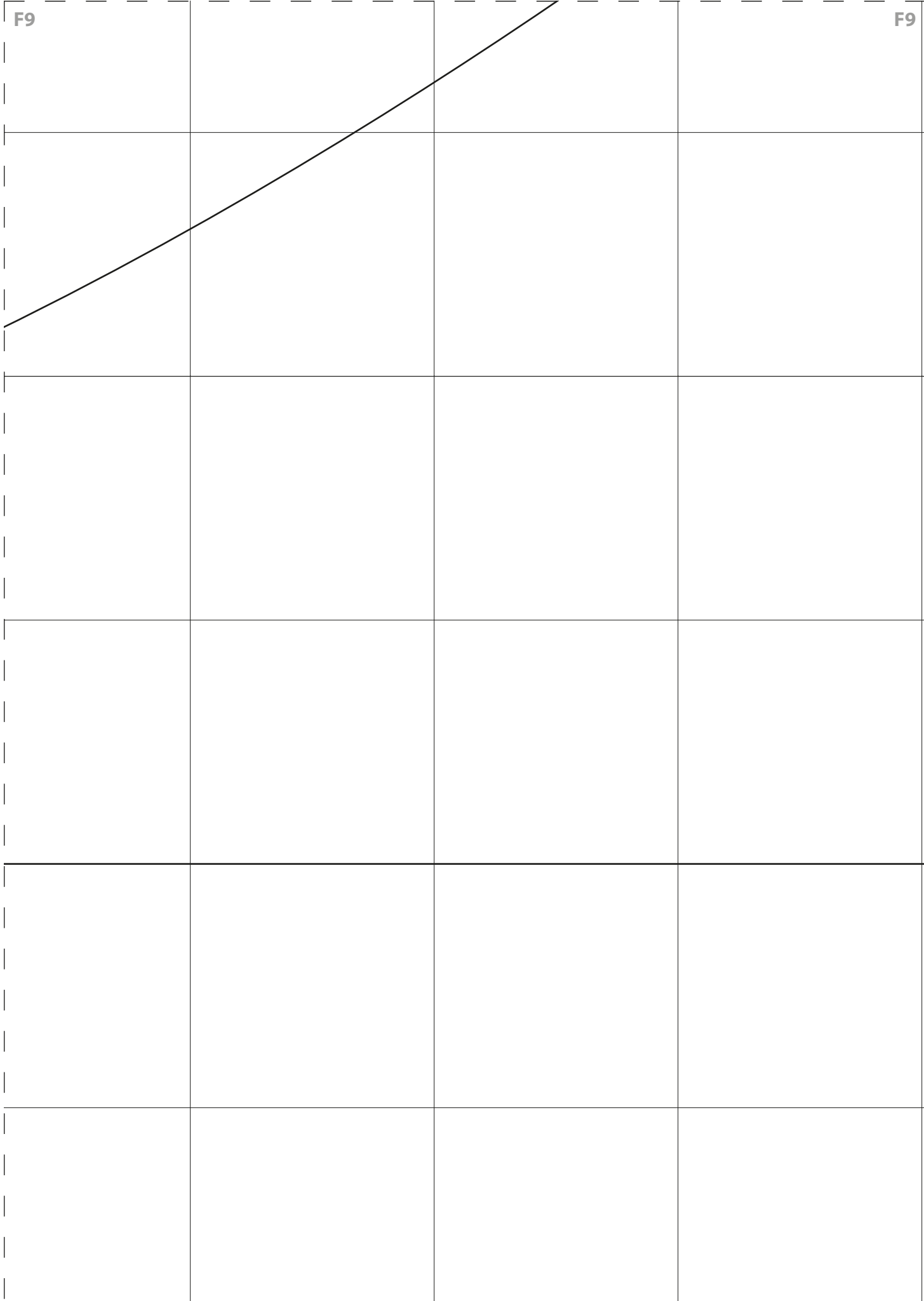

F9

F9