

SIDE FRONT
Cut 2 fabric

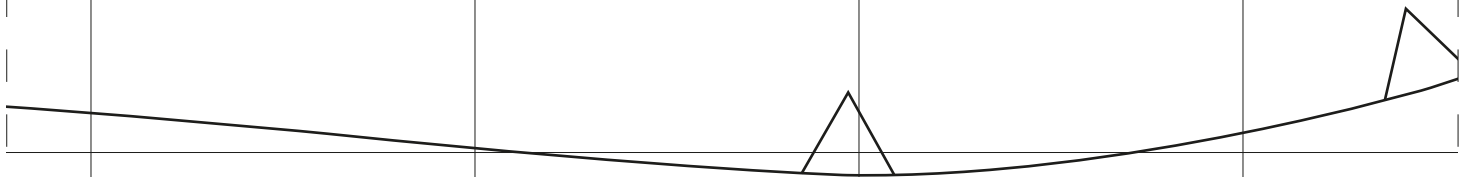

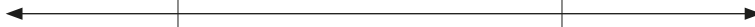

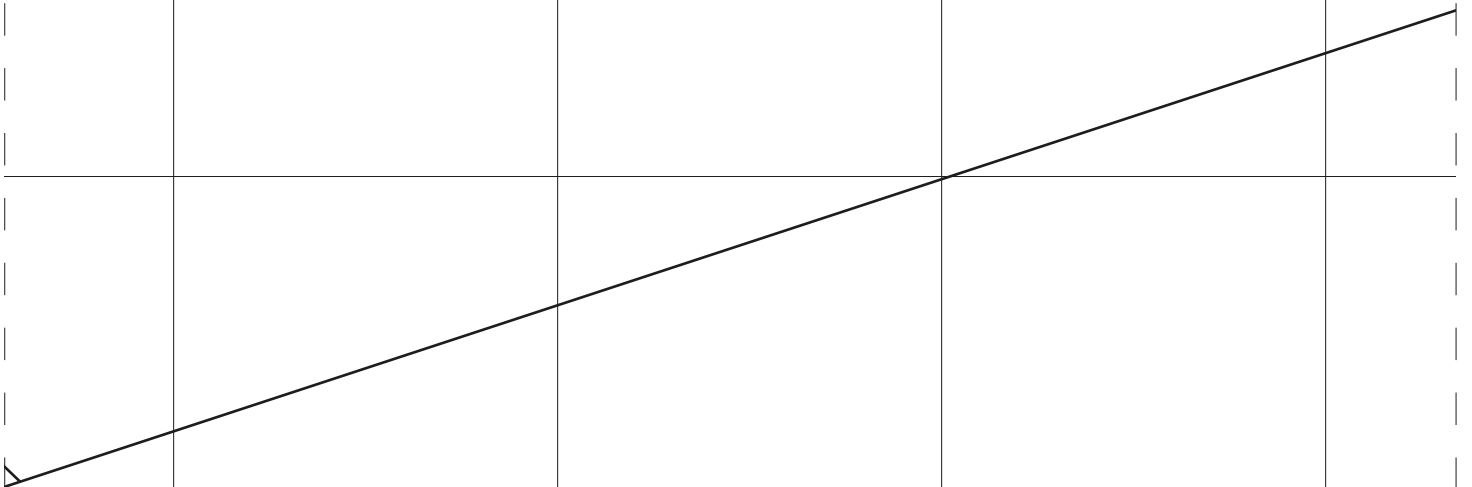

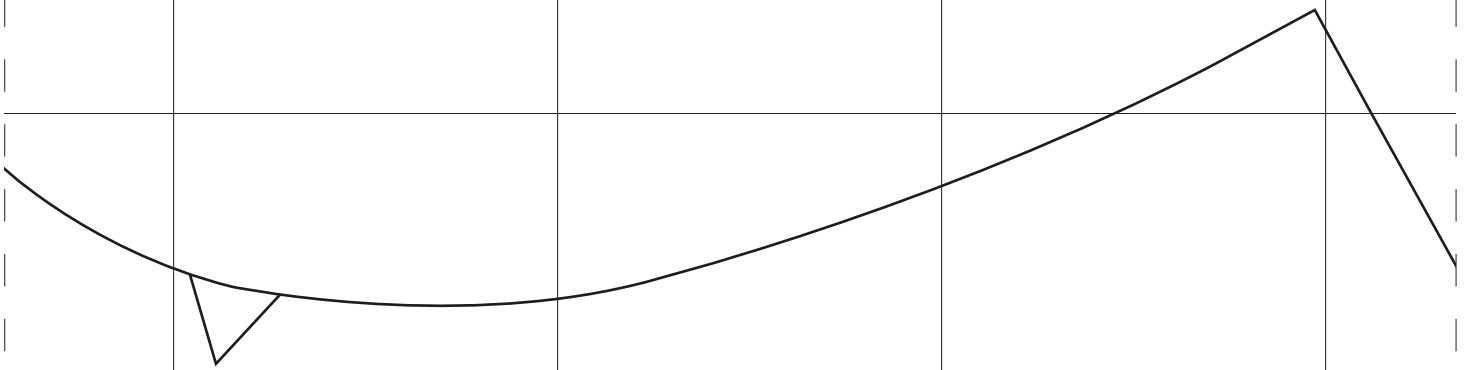
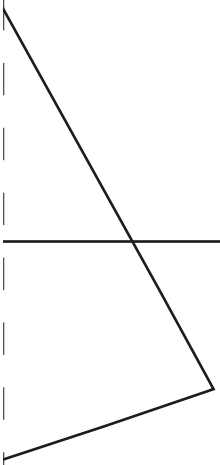
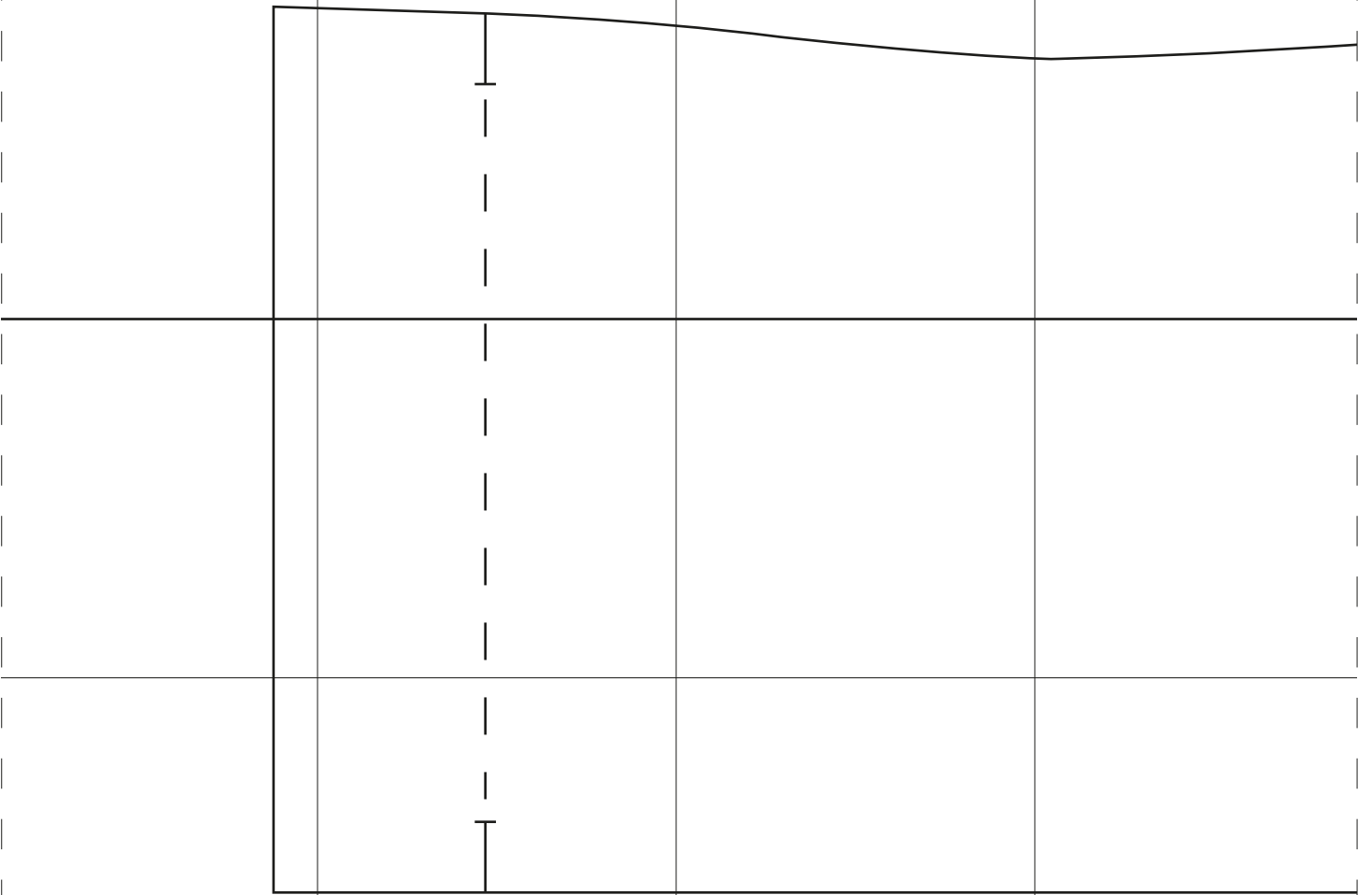

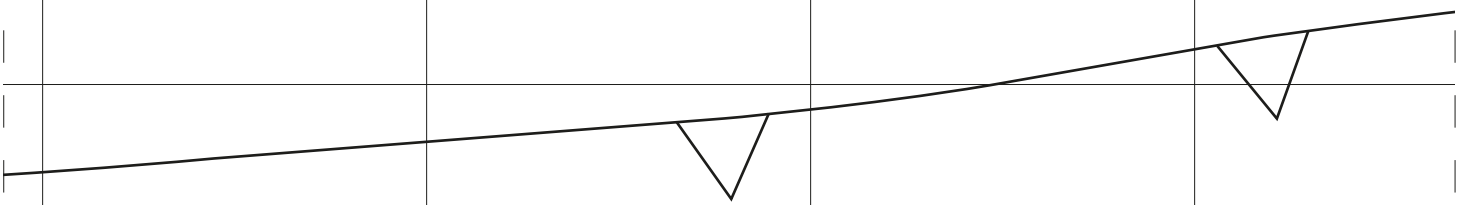

JACKET FRONT
Cut 2 fabric

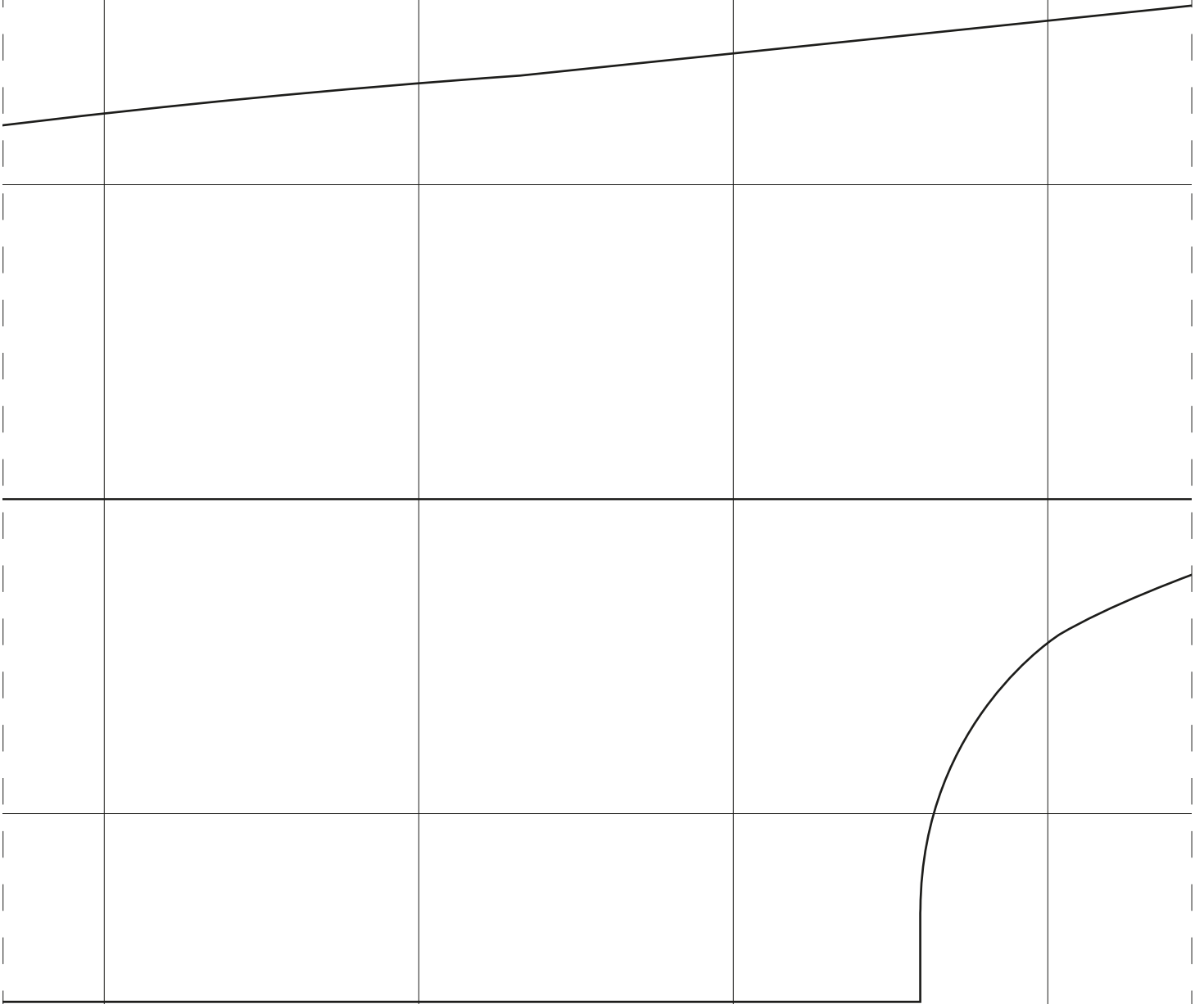



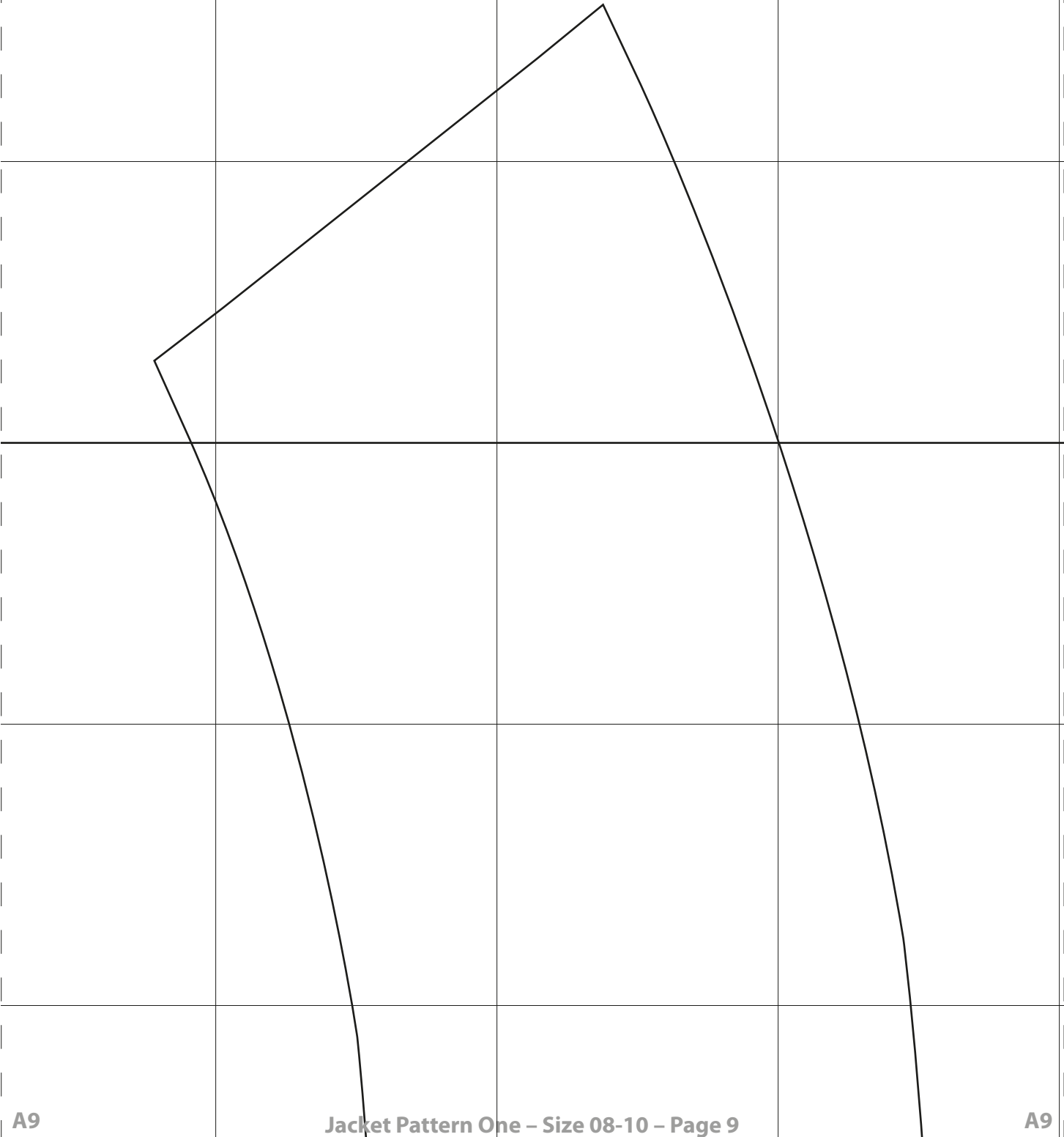

B1

B1

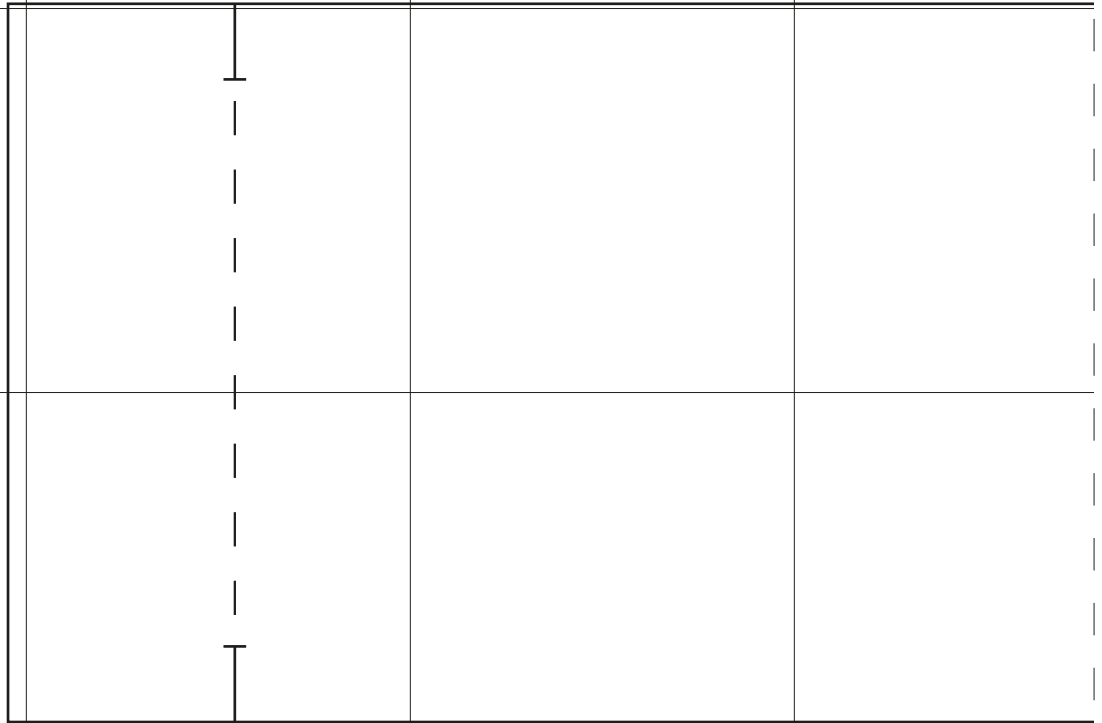

B1

B1

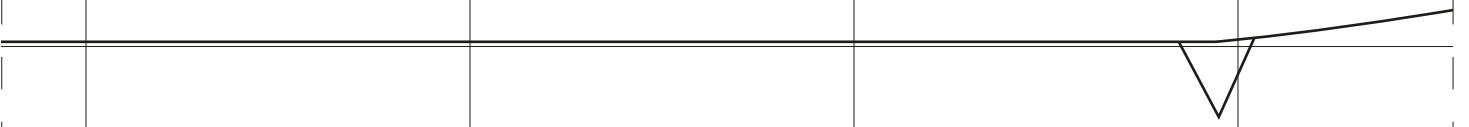

FRONT FACING
Cut 2 fabric
Cut 2 interfacing

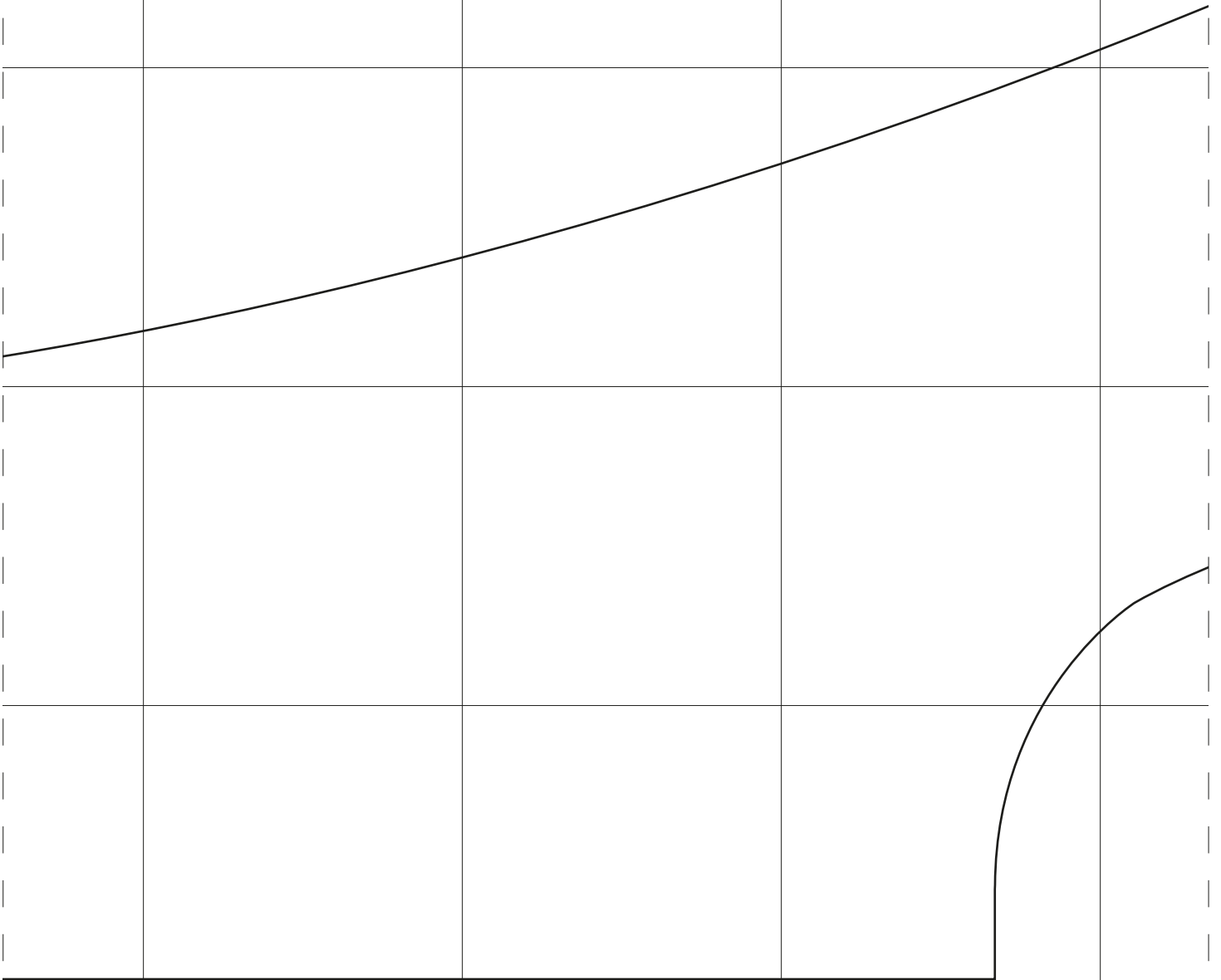

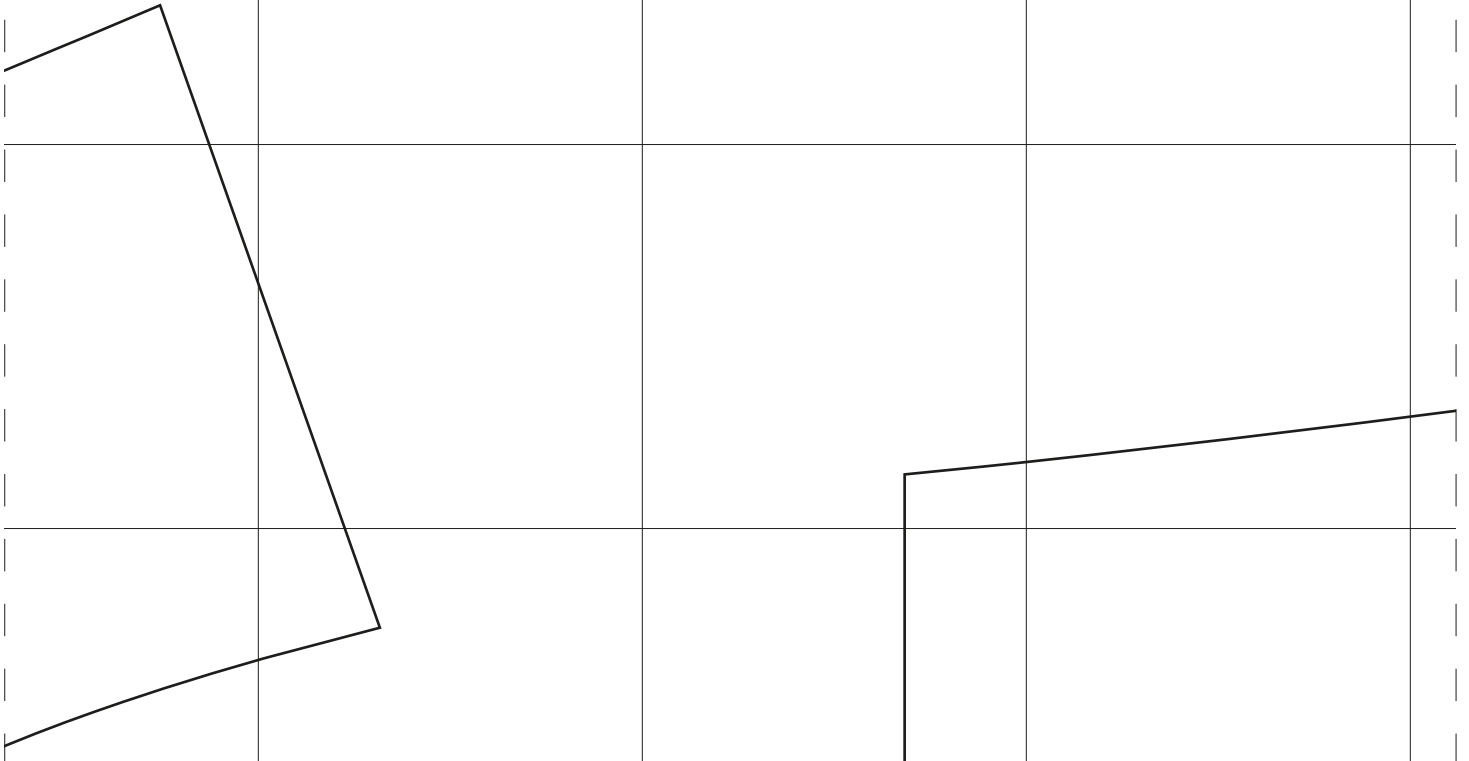

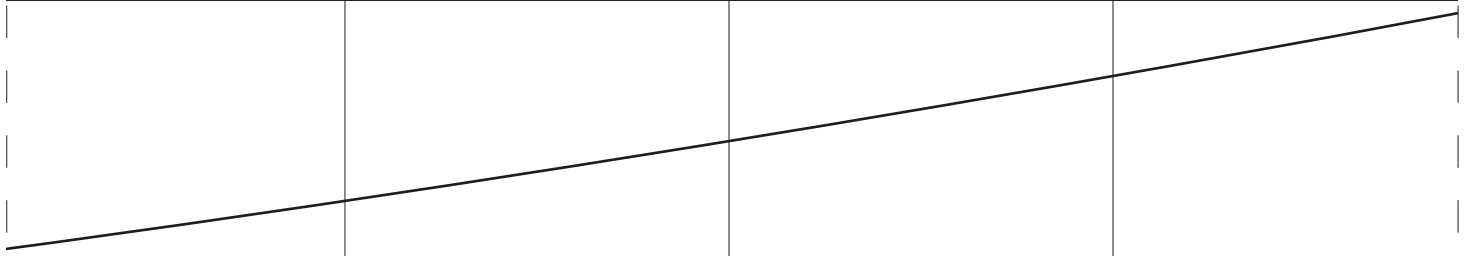

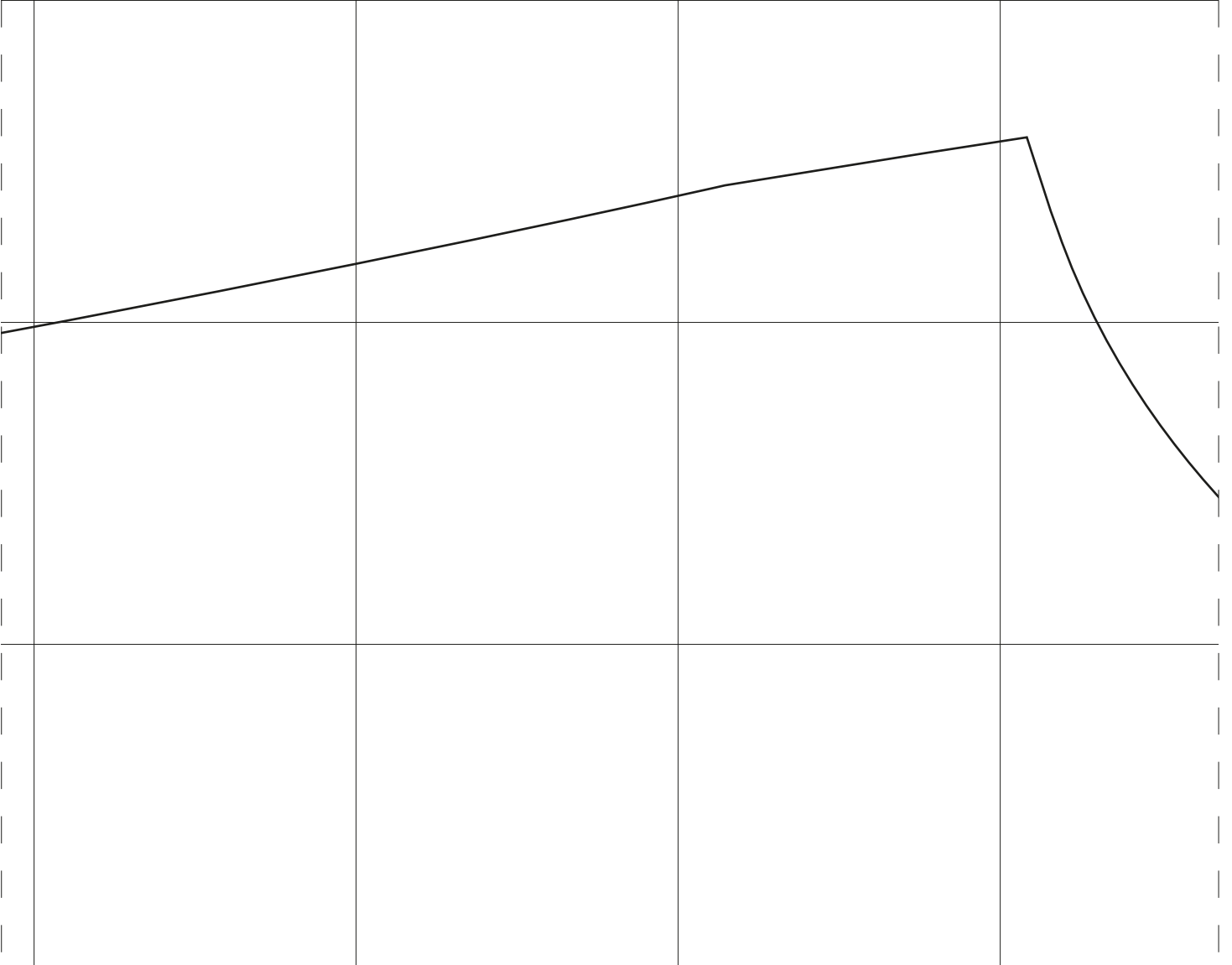

SLEEVE LINING
(Variation only)
Cut 2 lining

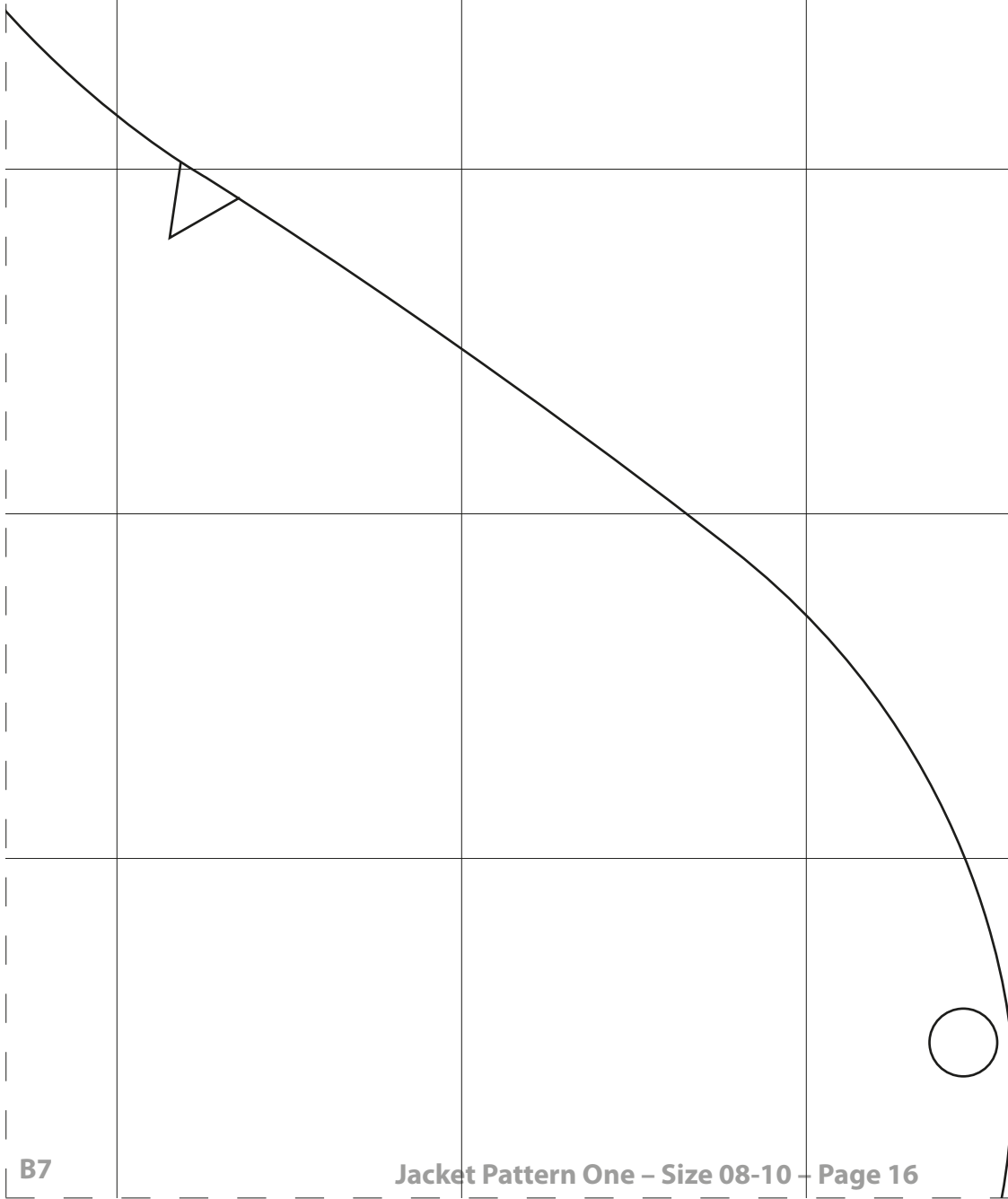

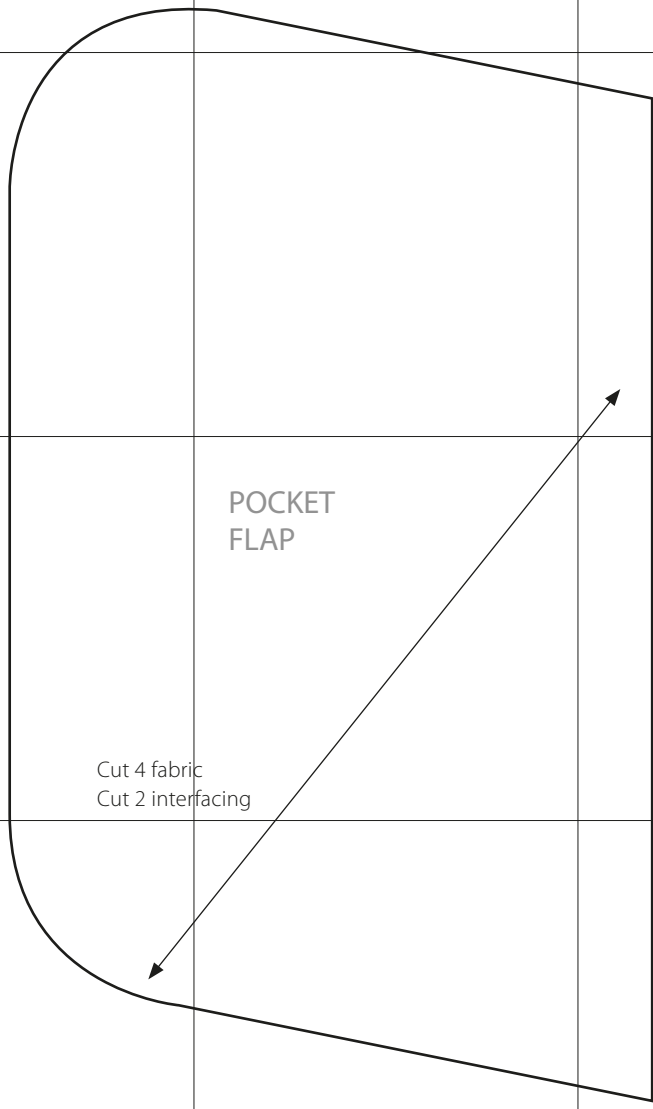

POCKET
FLAP

Cut 4 fabric
Cut 2 interfacing

COLLAR
(Variation only)
Cut 2 fabric
Cut 2 interfacing

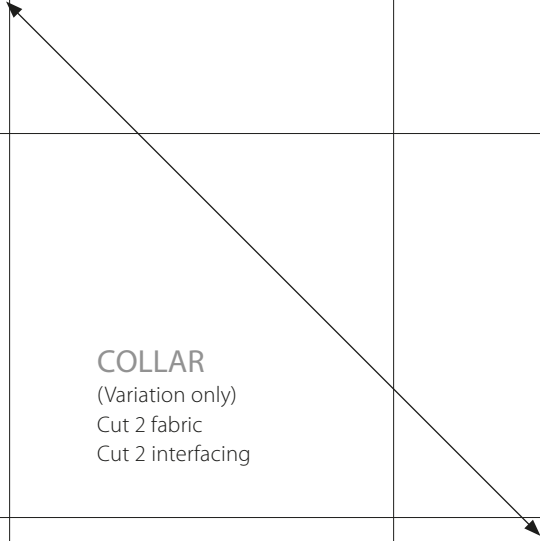

C1

C1

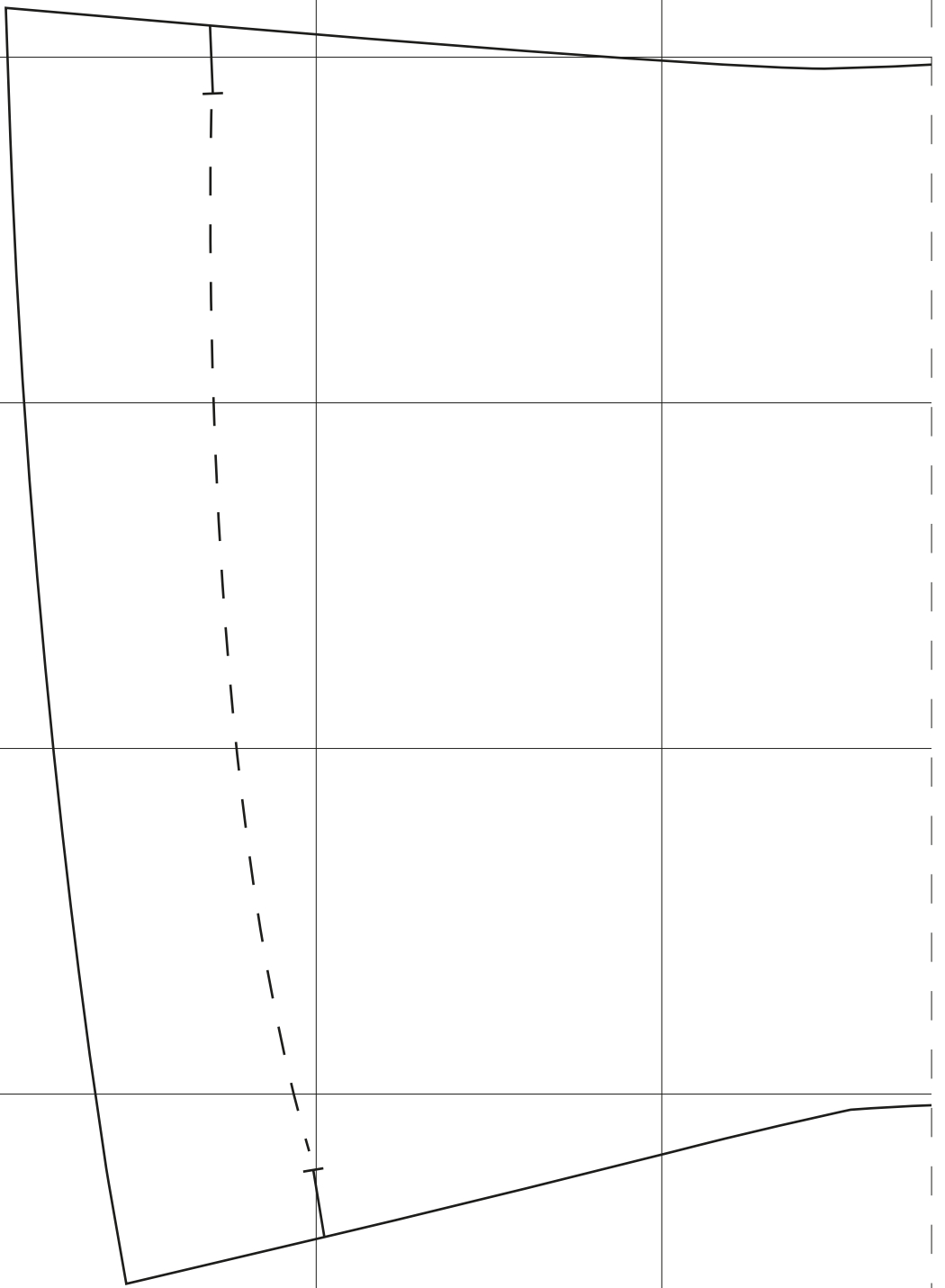

C1

C1

C2

C2



SIDE BACK
Cut 2 fabric

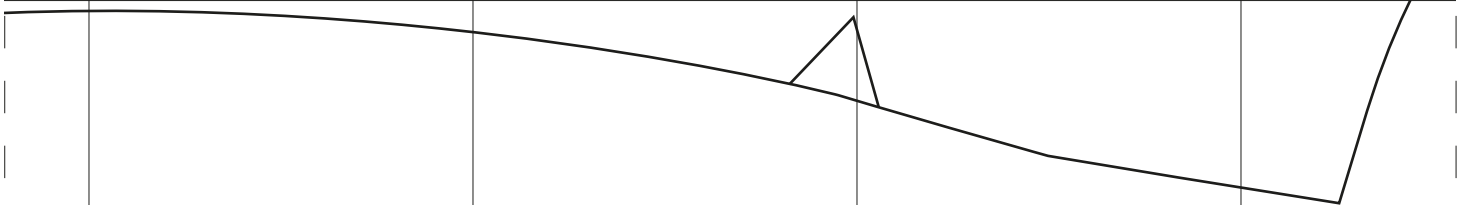

C2

C2

C3

C3

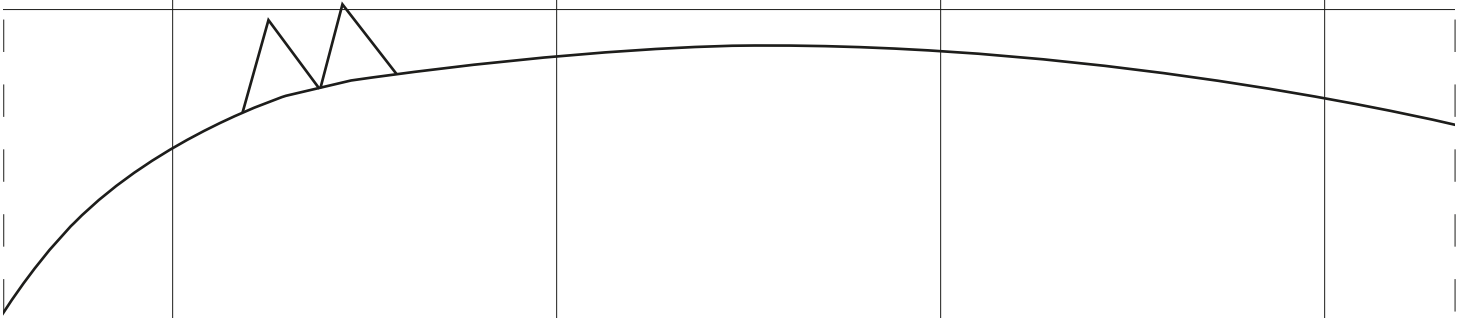
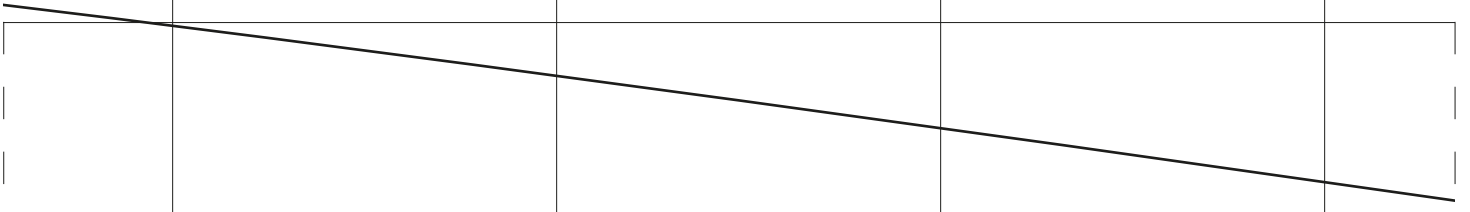

C3

C3

C4

C4

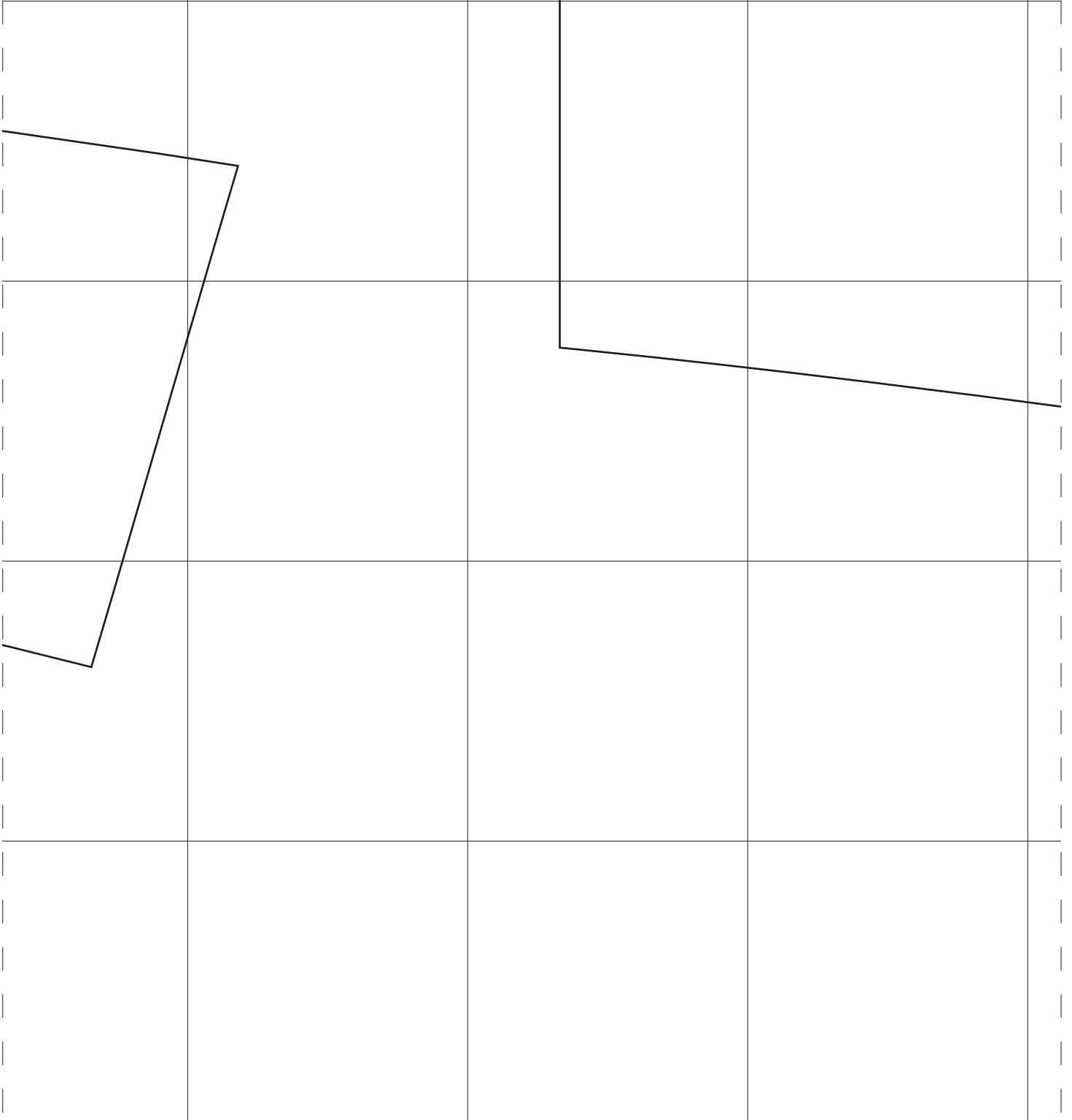

C4

C4

C5

C5

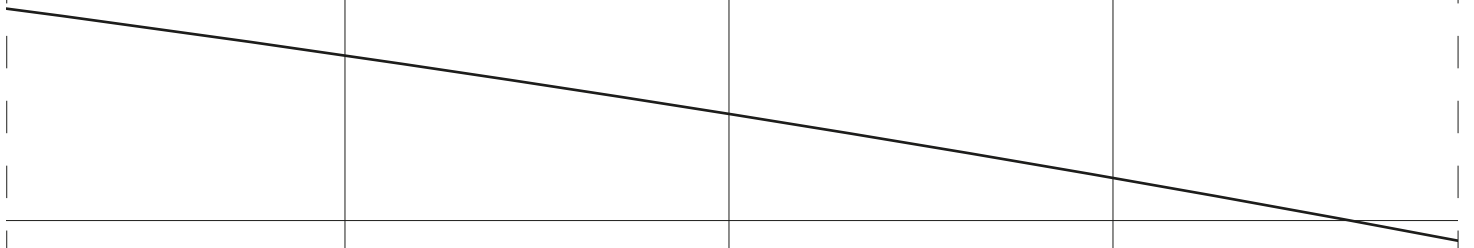

C5

C5

C6

C6

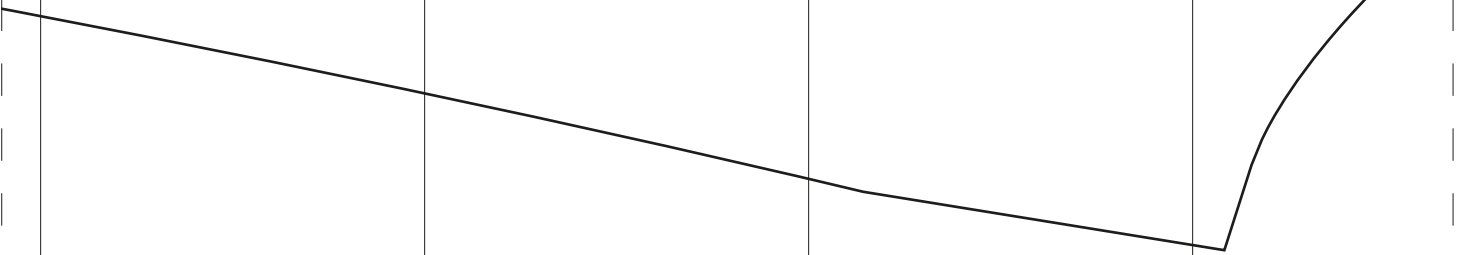

C6

C6

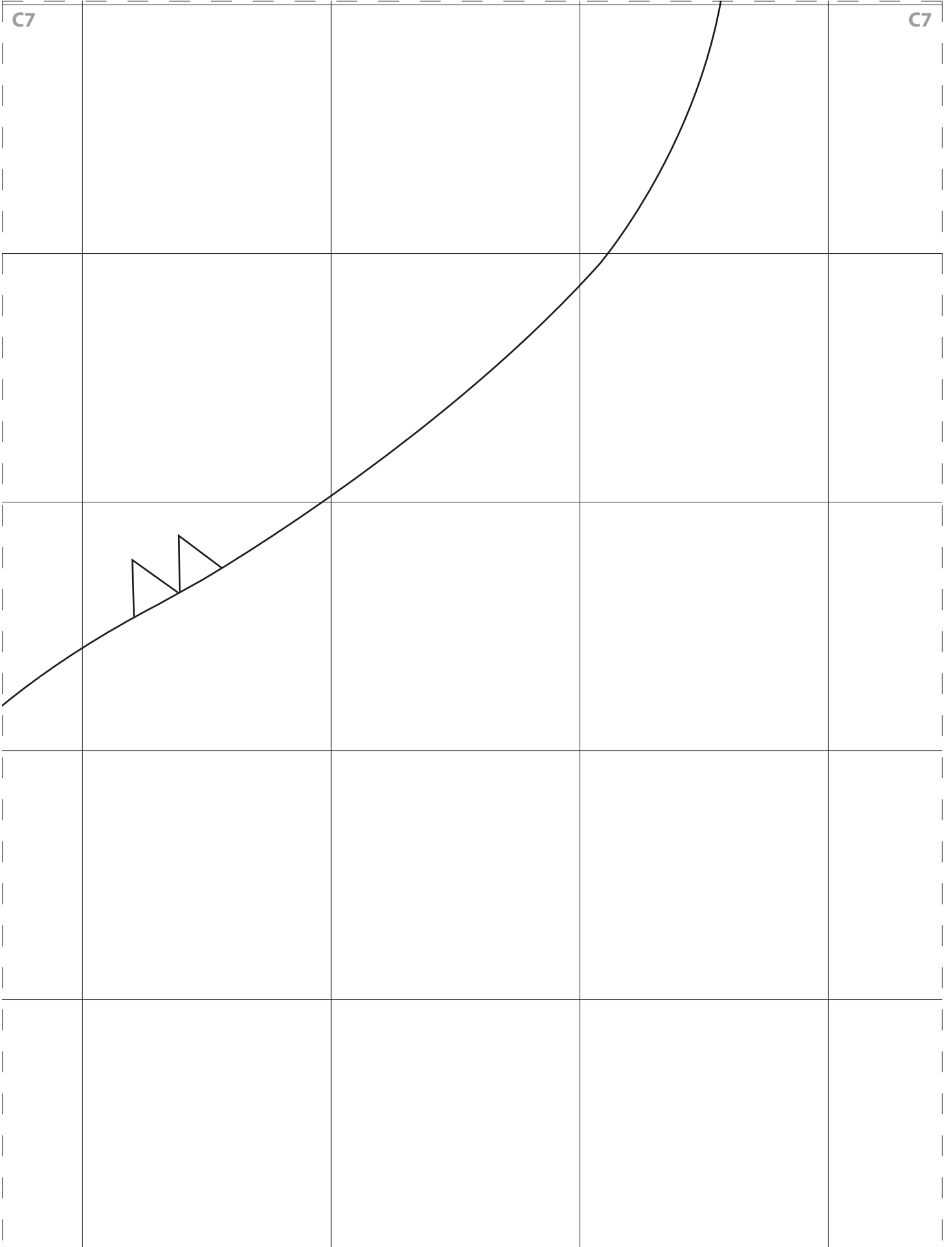

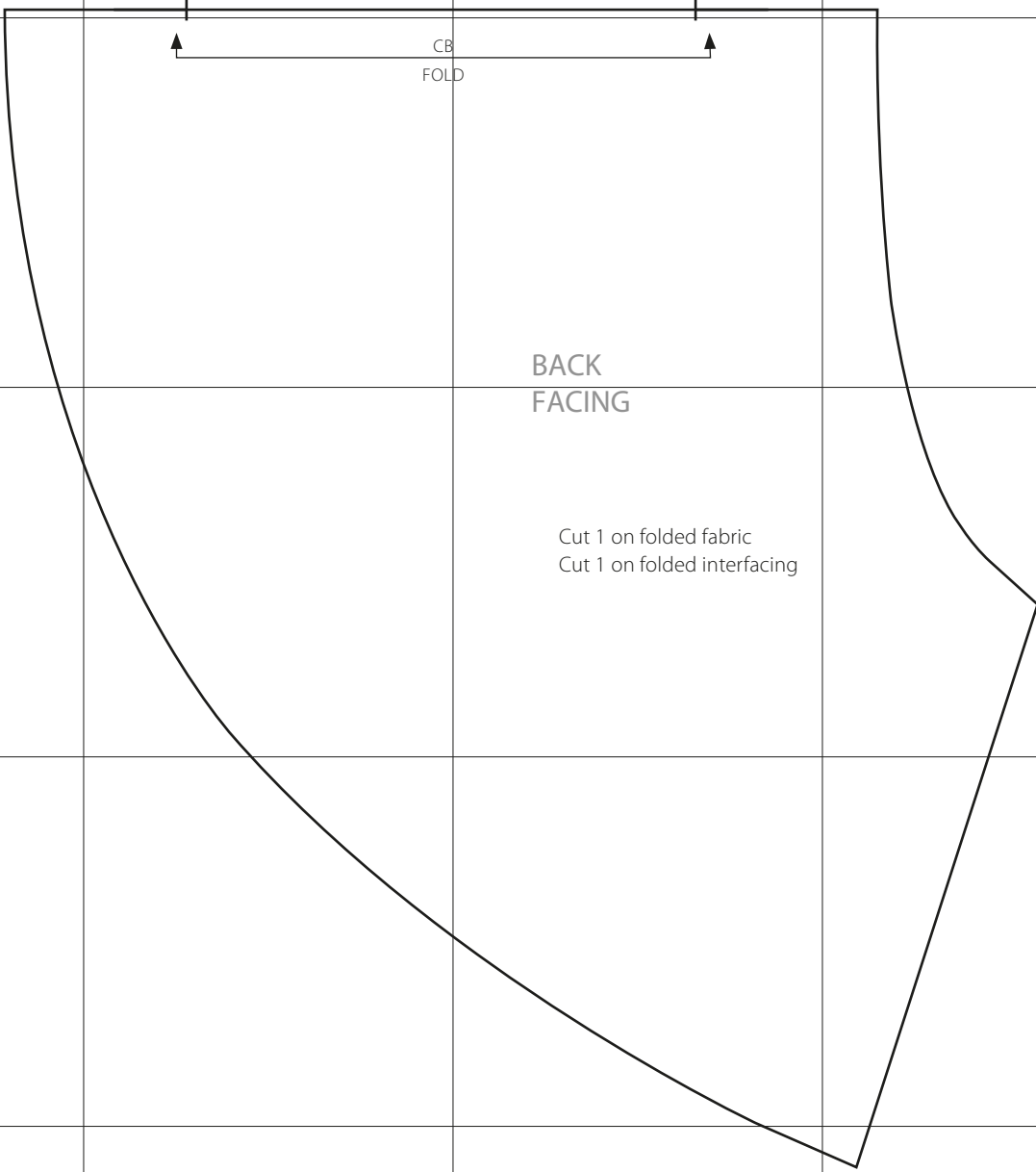

C9

C9

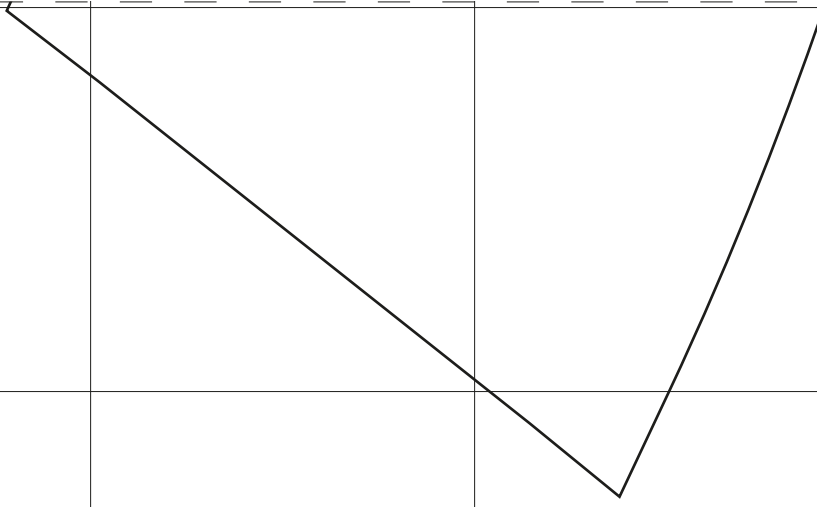

C9

C9

D1

D1

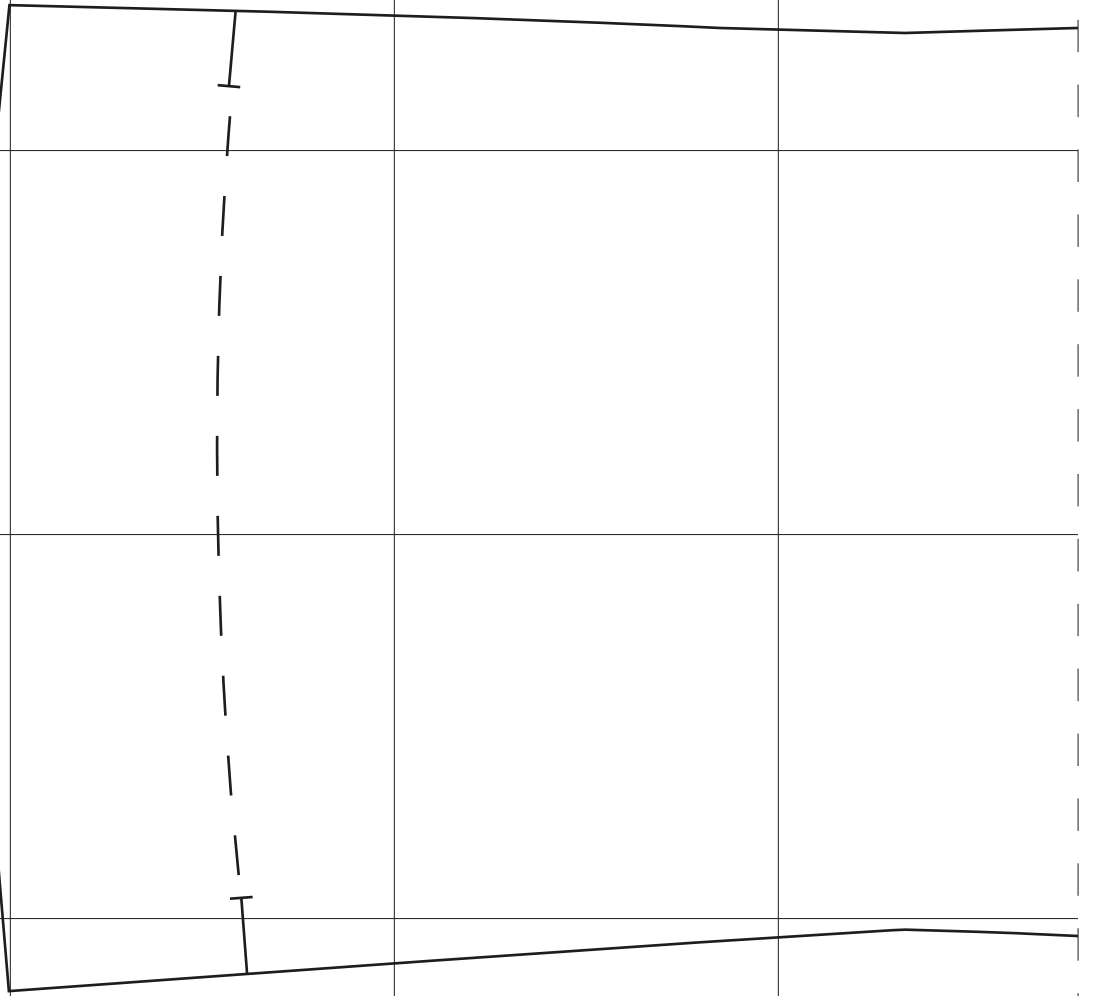

D1

D1

D2

D2

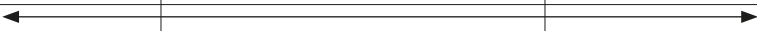

JACKET BACK
Cut 2 fabric



D2

D2

D3

D3



D3

D3

D4

D4

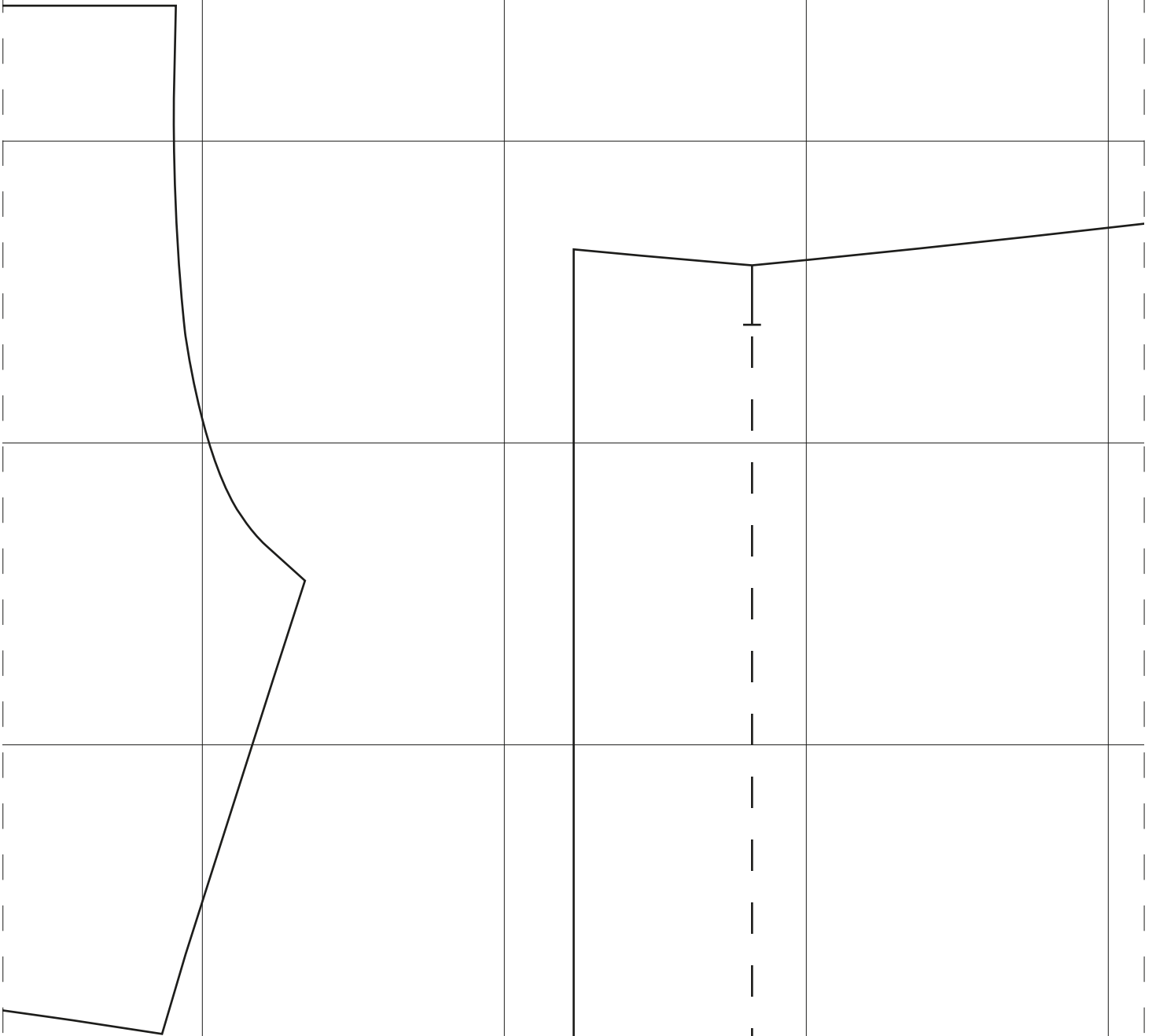

D4

D4

D5

D5

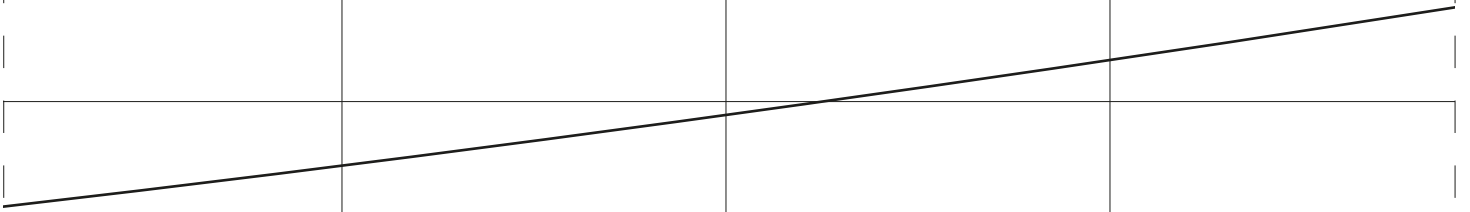

D5

D5

D6

D6

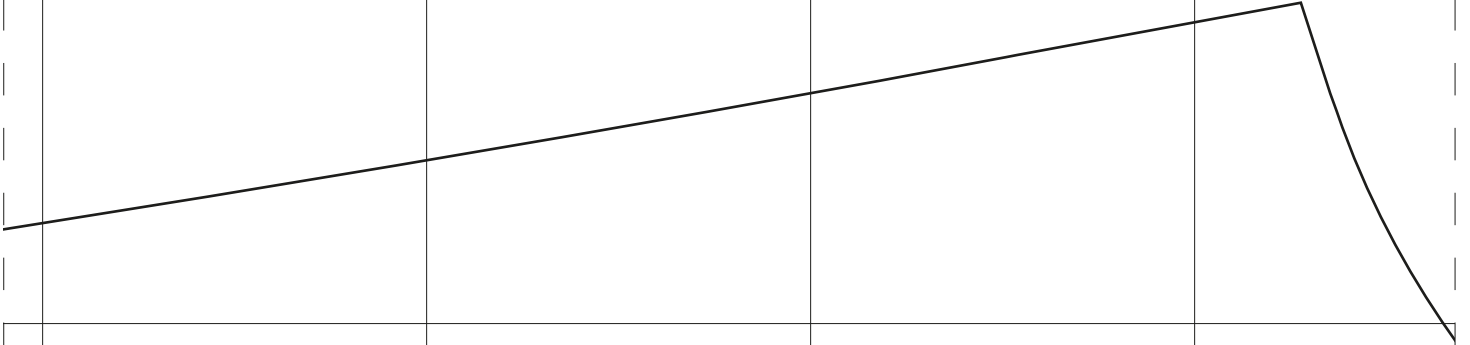

SLEEVE
Cut 2 fabric

D6

D6

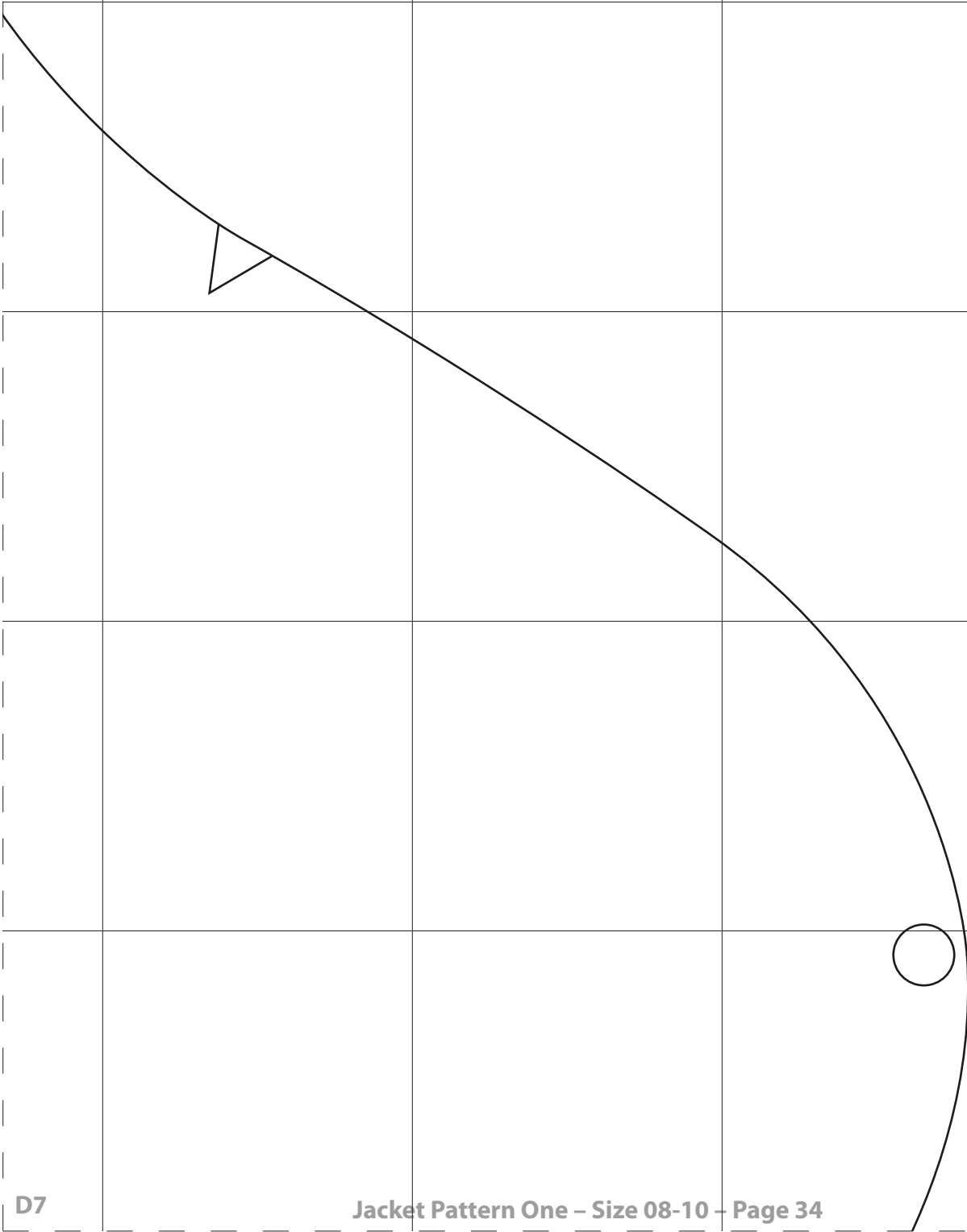

E1

E1

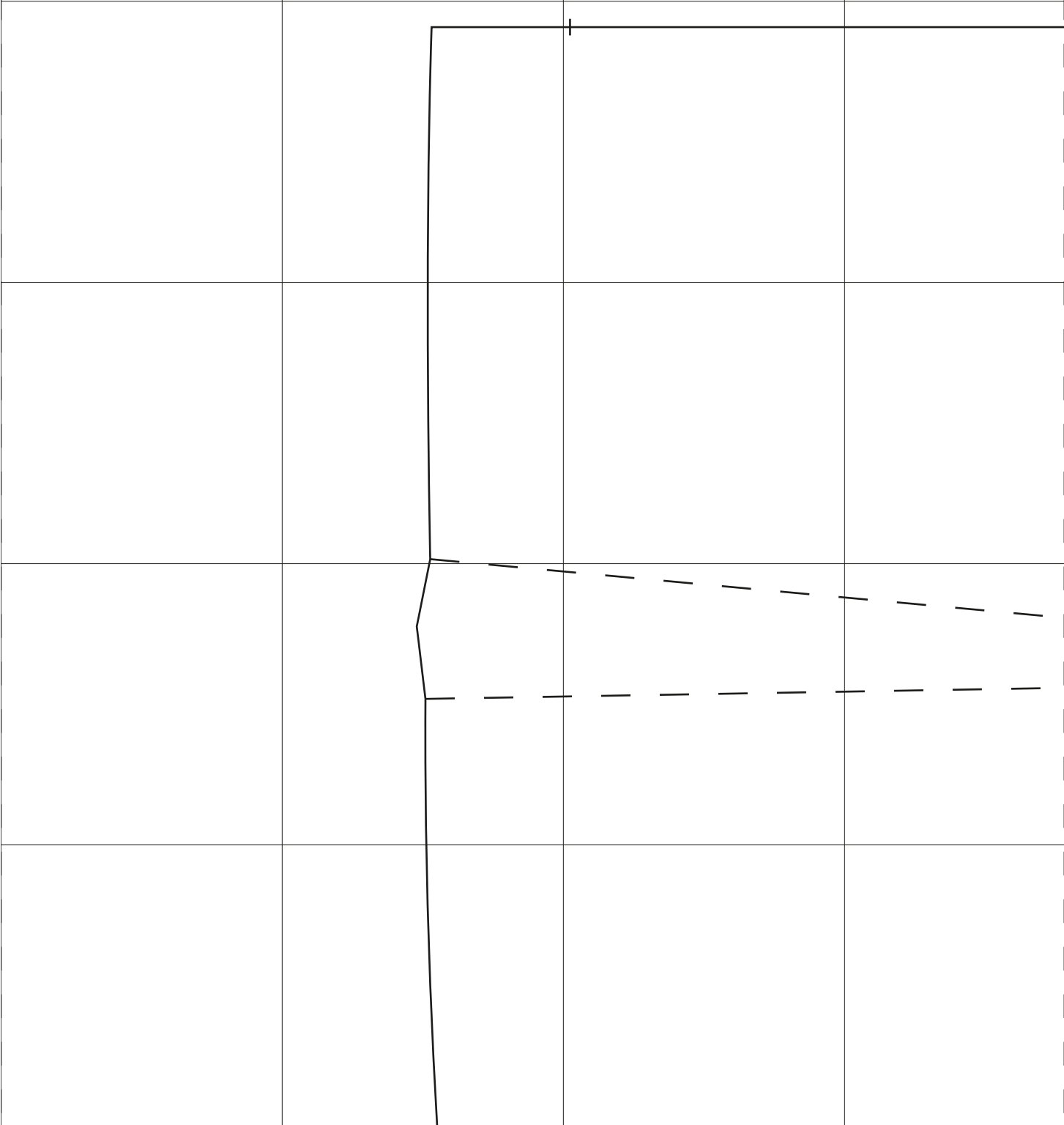

E1

E1



BACK LINING
(Variation only)
Cut 1 on folded lining

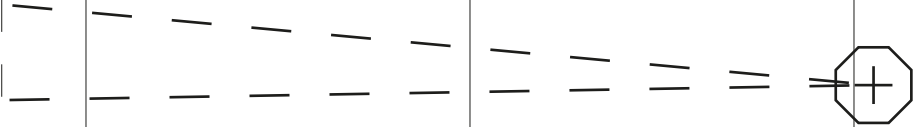

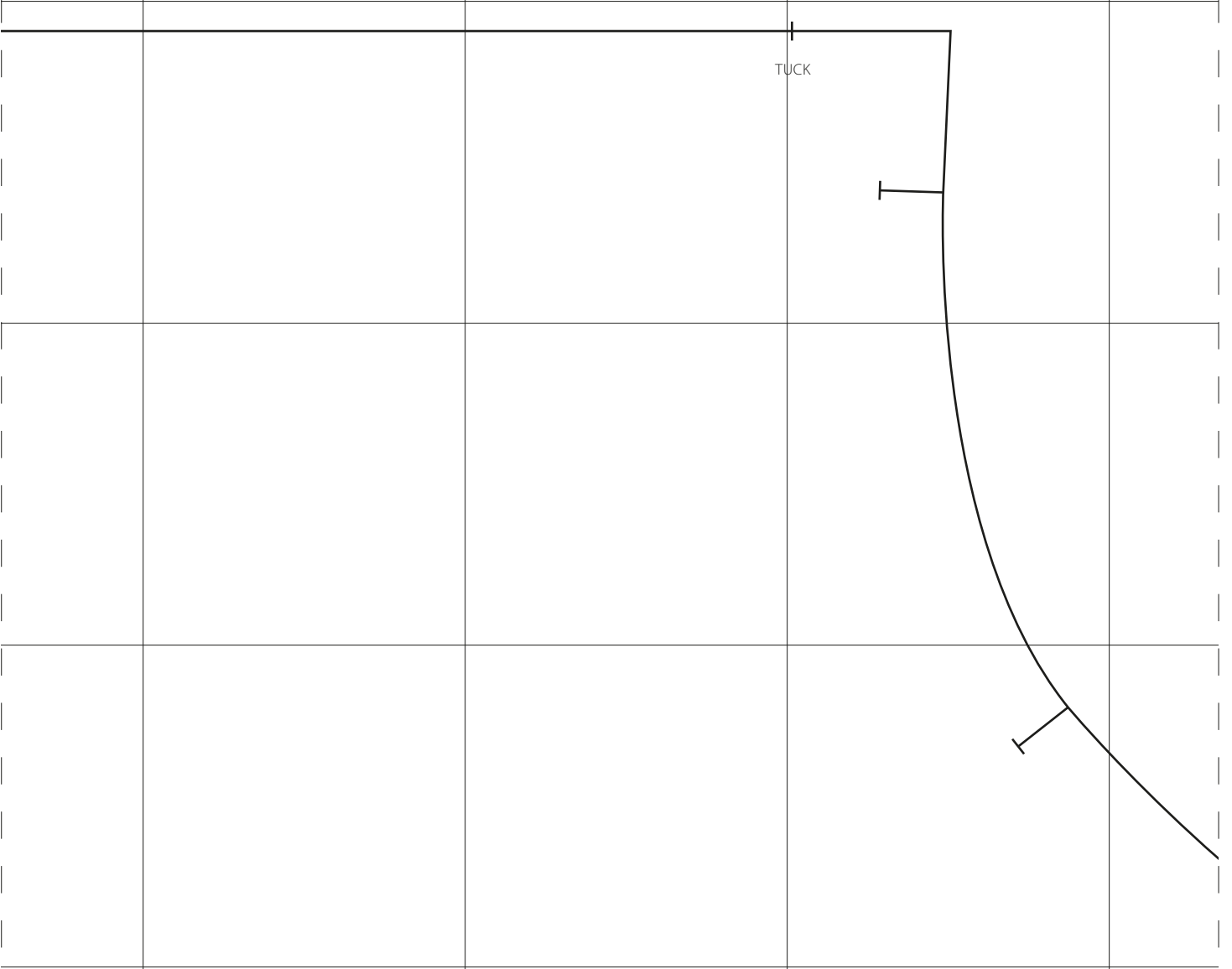

E4

E4

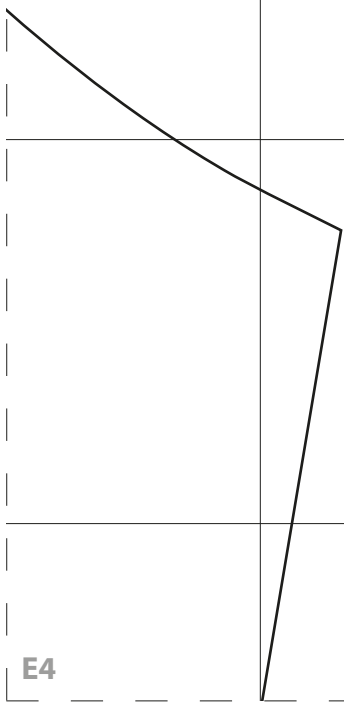
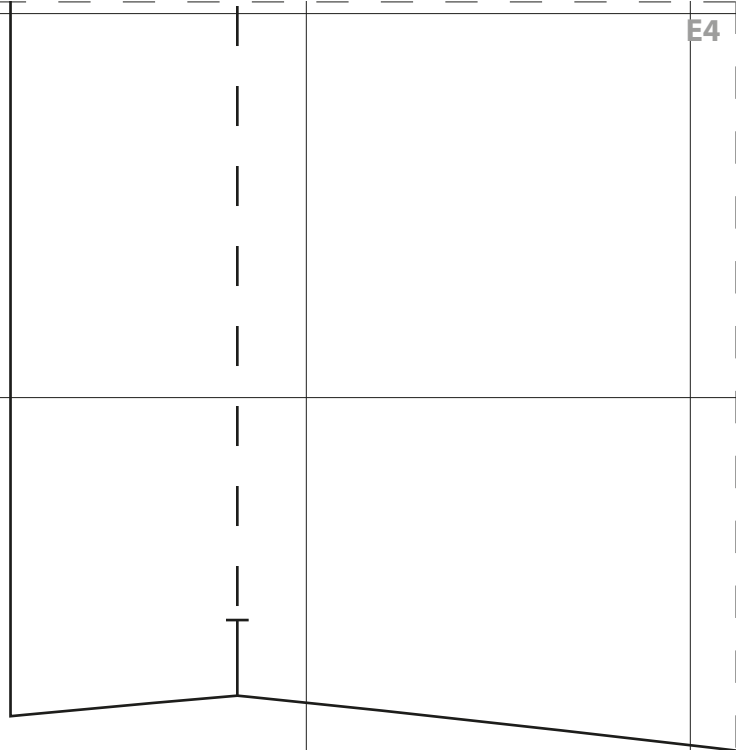

E4

E4

E5

E5

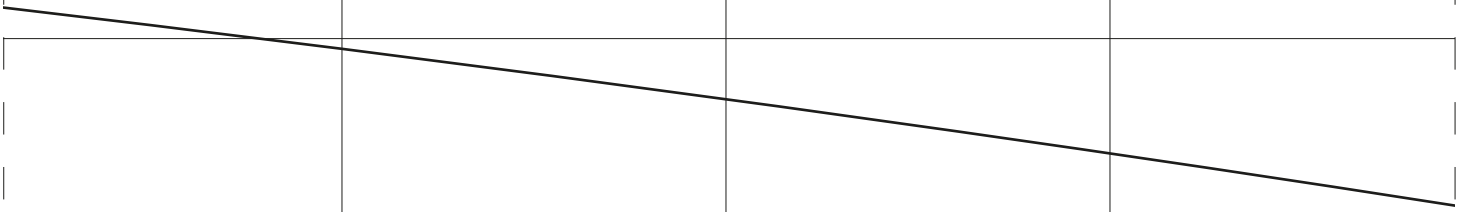

E5

E5

E6

E6



E6

E6

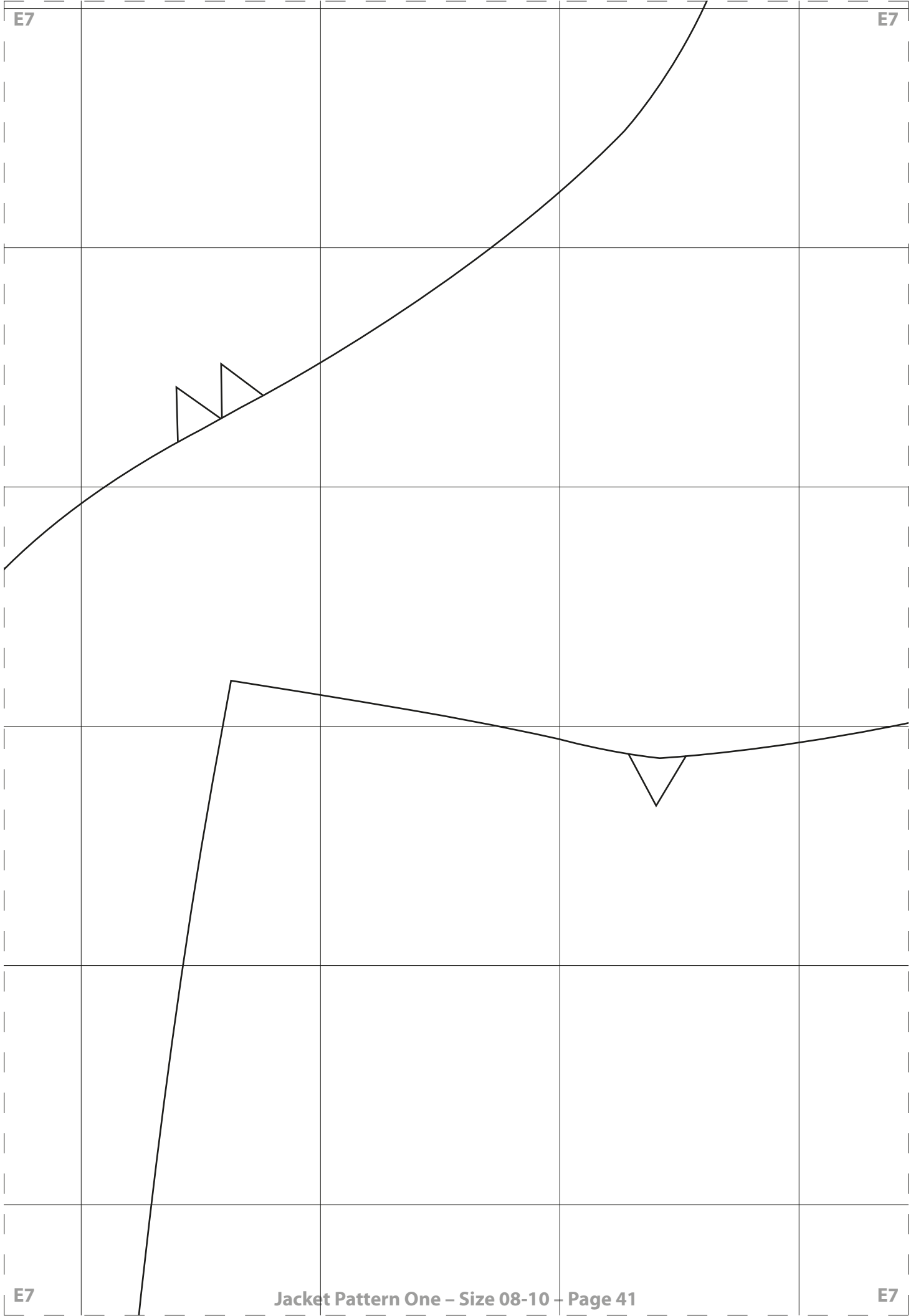

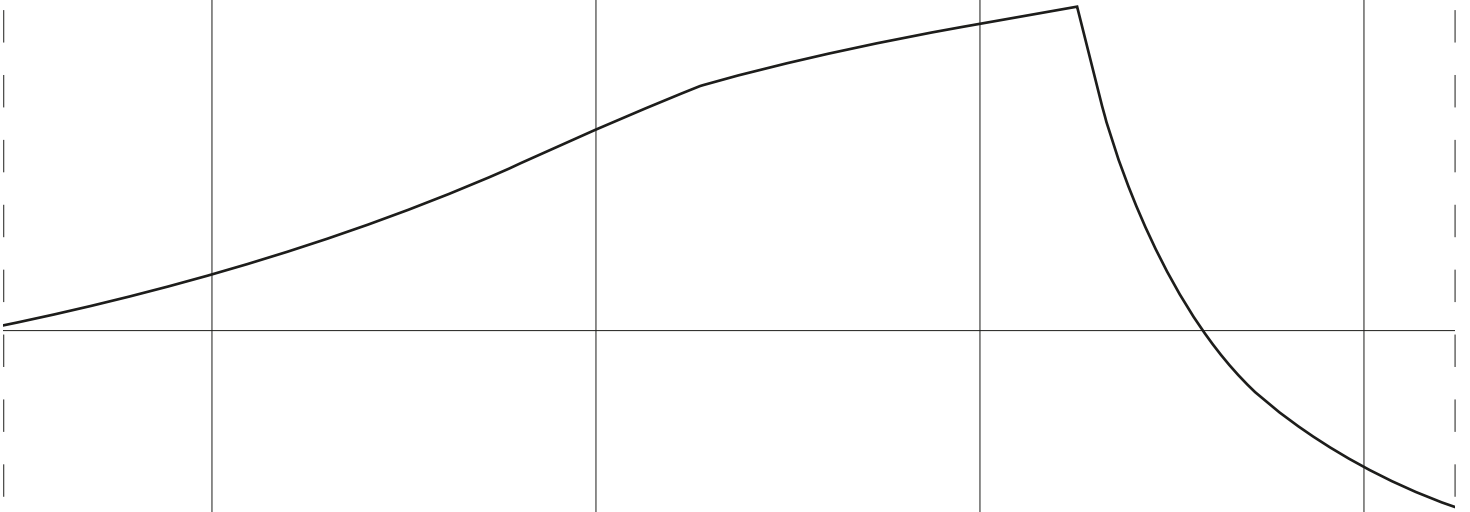

FRONT LINING
(Variation only)
Cut 2 lining

E9

E9

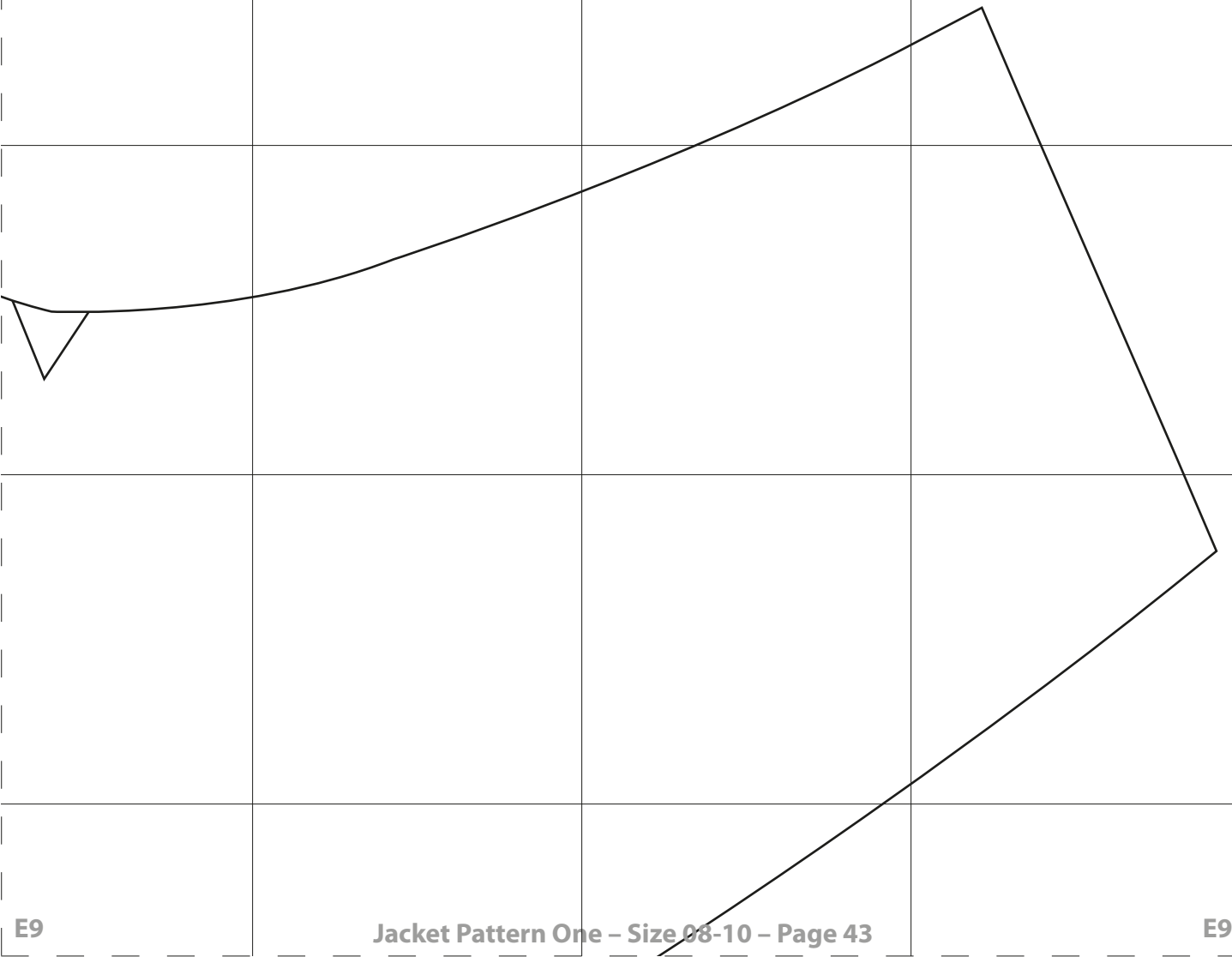

E9

E9

F1

F1



F1

F1

F2

F2

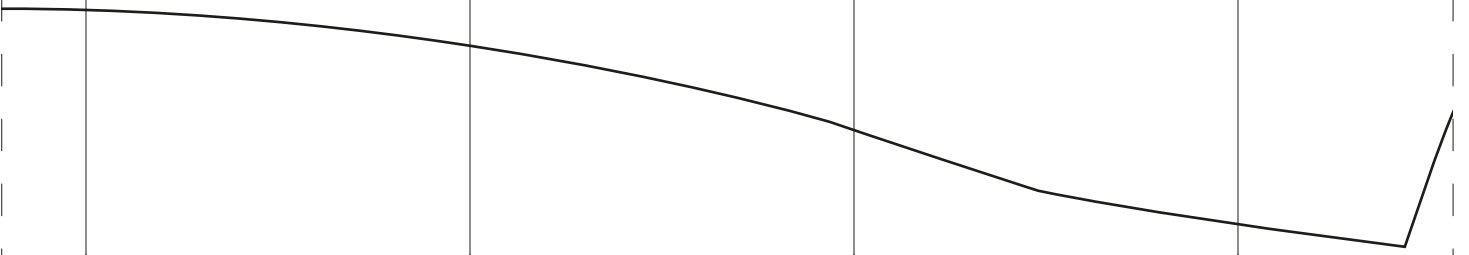

F2

F2

F3

F3

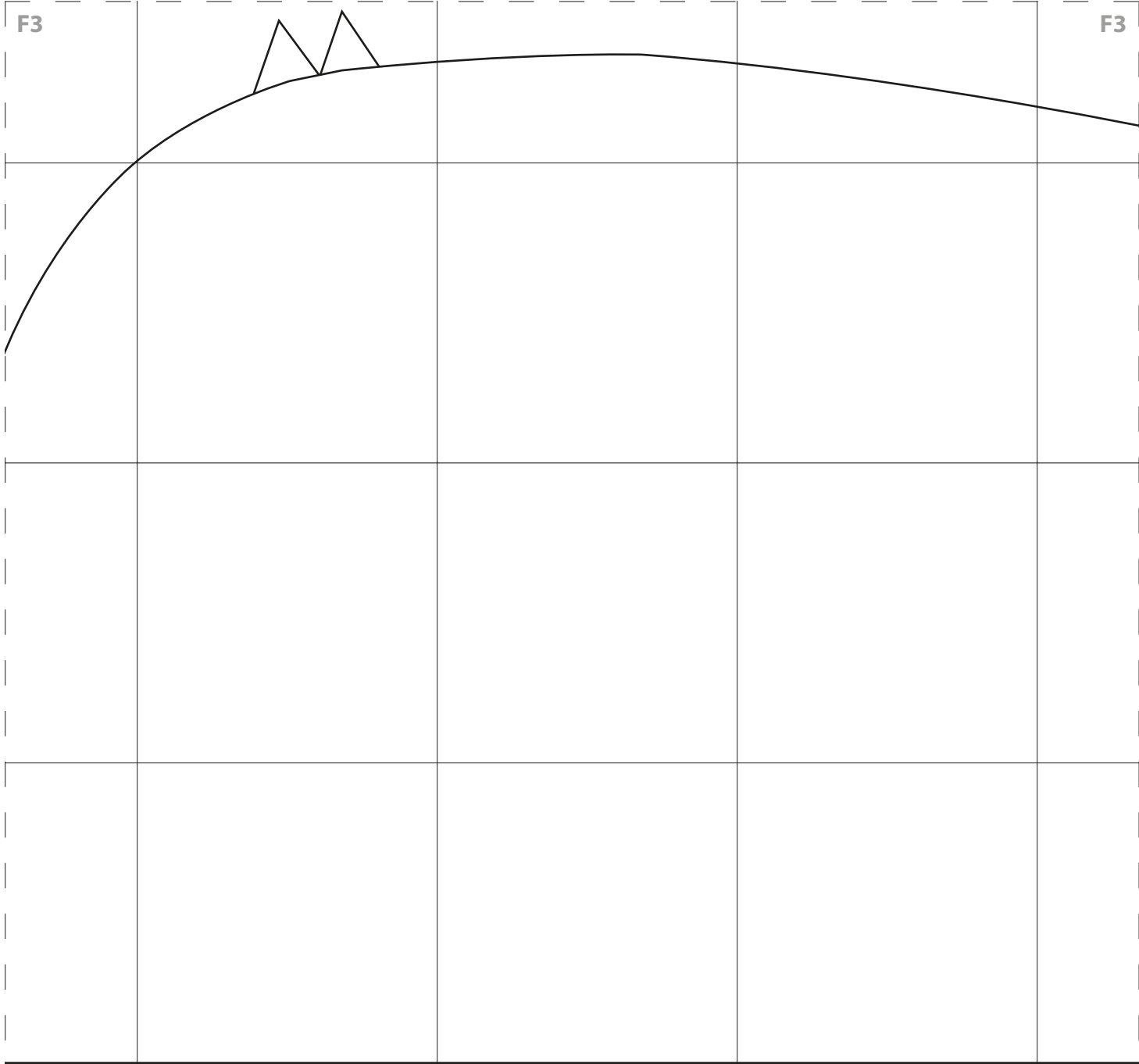

F3

F3

F4

F4

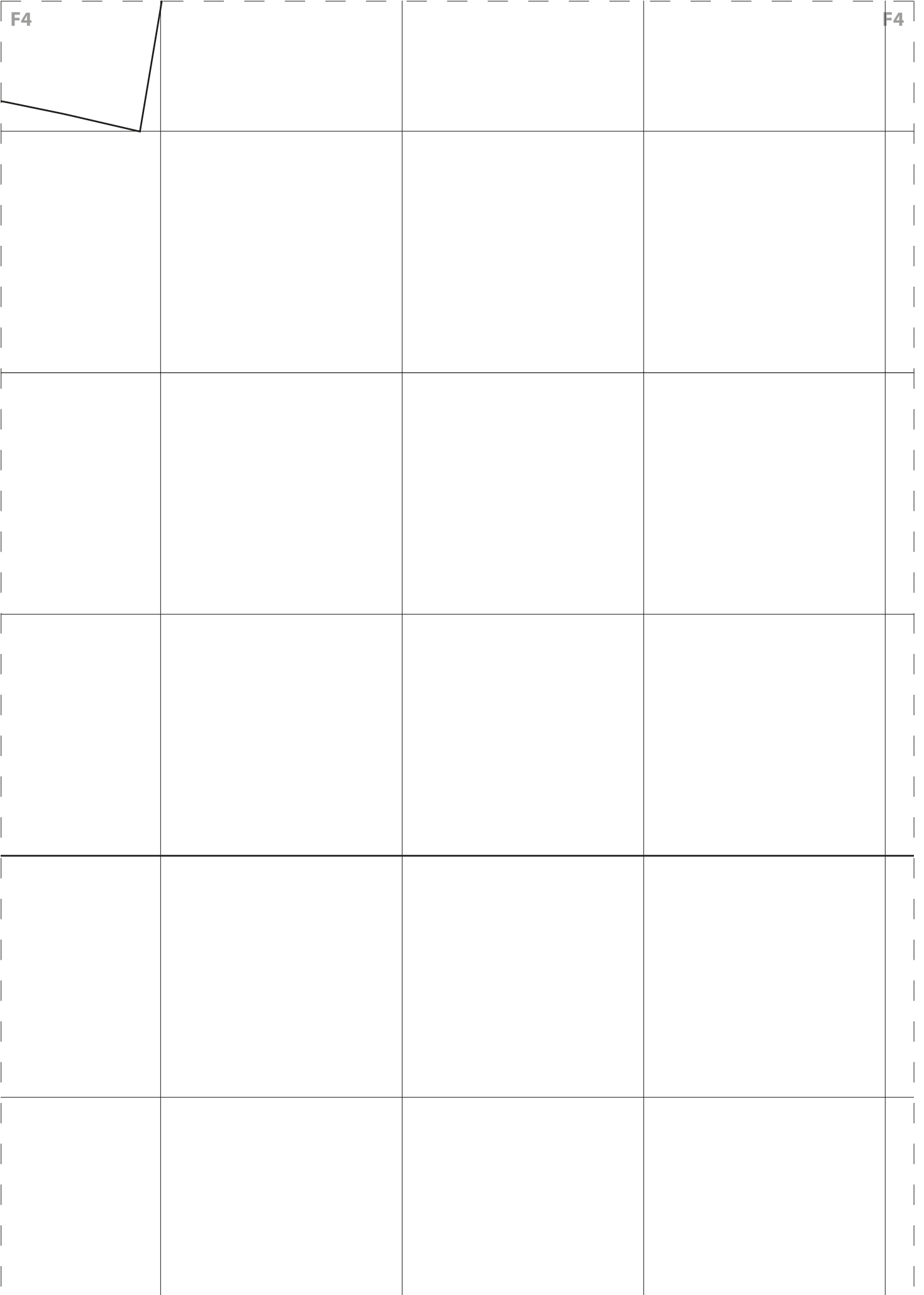

F4

F4

F5

F5

F5

F5

F6

F6

F6

F6

F7

F7



F7

F7

F8

F8

TUCK

F8

F8

F9

F9

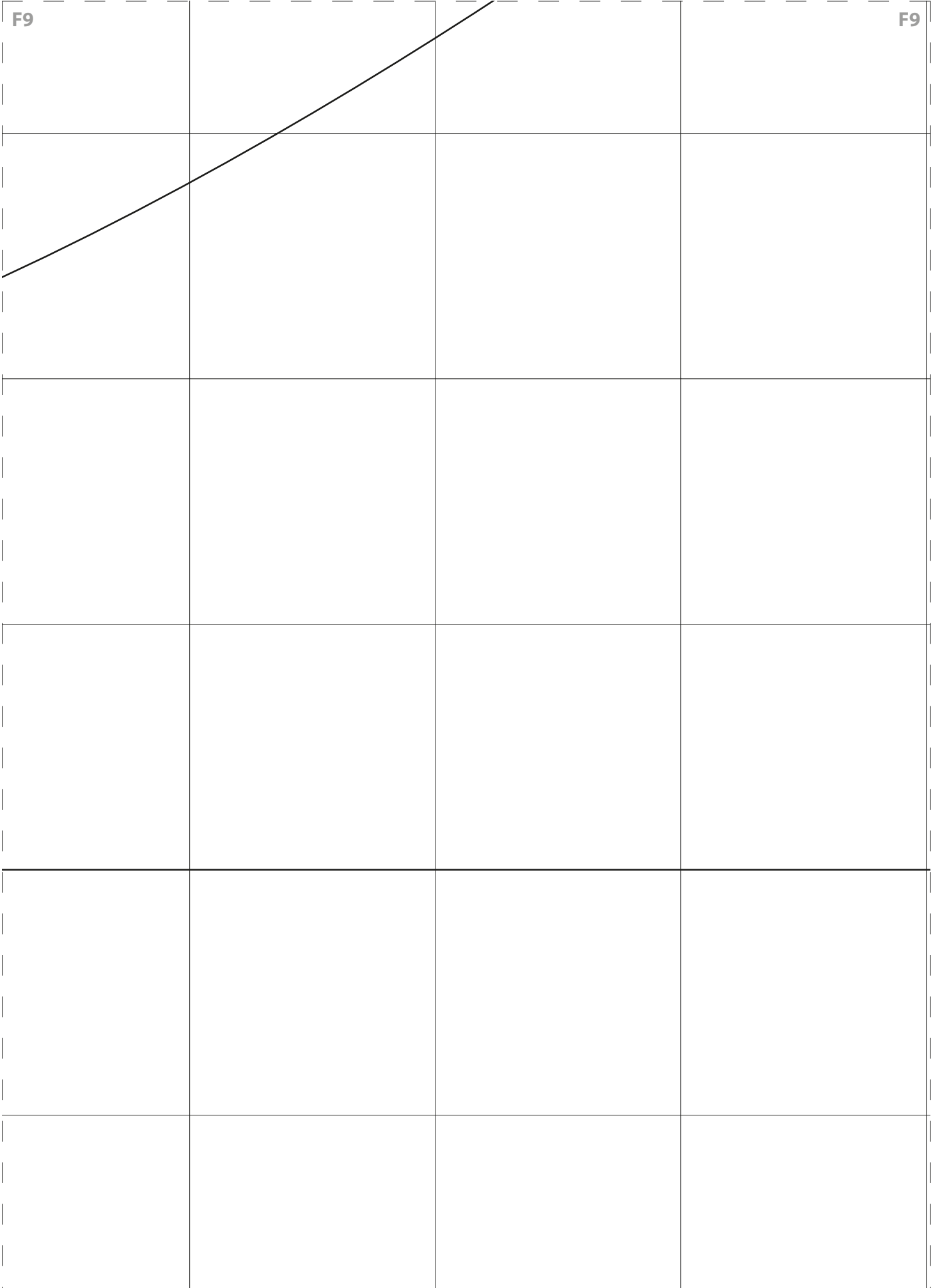

F9

F9