

- (1) Tabletop (x1)
- (4) Wooden Dowels (x4)

- (2) Legs (x2)
- (5) Screws (x48)

- (3) Plates (x2)
- + Screwdriver

Inserting the Dowels ⁽⁴⁾ into the Legs ⁽²⁾

Take one leg and locate the two upper holes.
Insert two wooden dowels into these holes.
Repeat the process with the second leg.

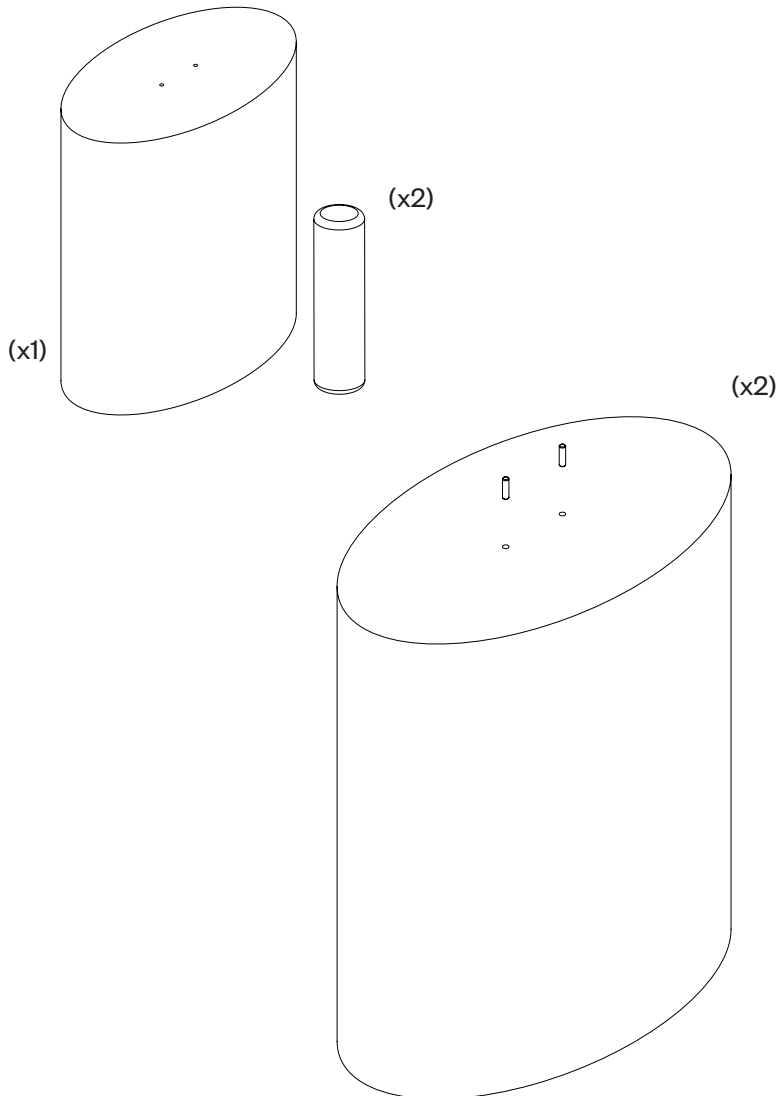

Fitting the Plate ⁽³⁾ onto the Leg ⁽²⁾

Take a plate and place it on the leg so that its holes align with the wooden dowels. Ensure the plate is properly adjusted. Repeat the process with the second leg.

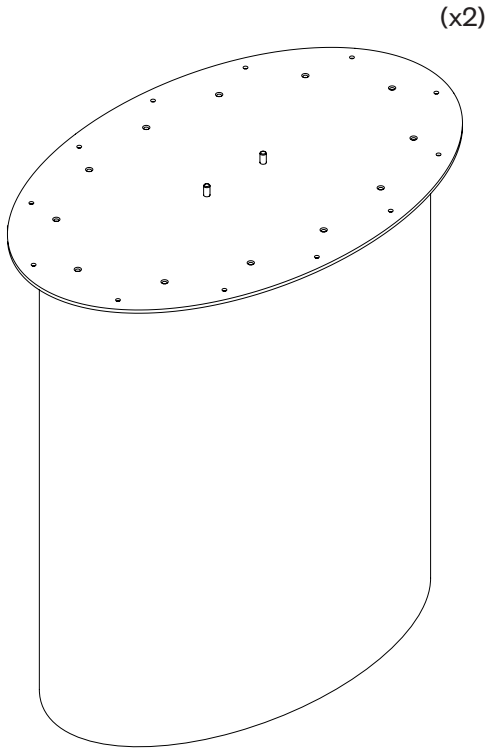
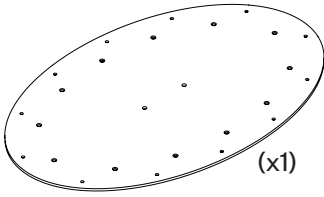

Securing the Plate ⁽³⁾ to the Leg ⁽²⁾

Use screws to attach the plate to the leg.
Align the screws with the guide marks on the bottom of the plate.
Tighten the screws with a screwdriver until the plate is firmly secured.

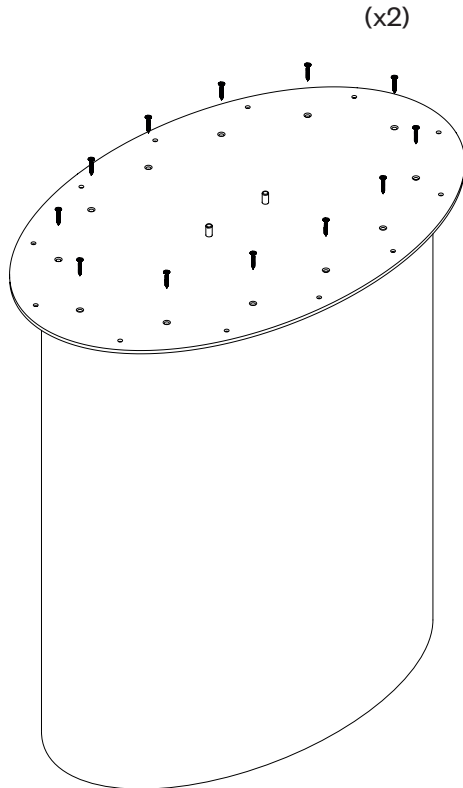

Mounting the Tabletop ⁽¹⁾ onto the Legs ⁽²⁾

Place the tabletop onto the legs.

Make sure the wooden dowels on each leg align with the corresponding holes in the tabletop.

Gently press down to fit the dowels into the holes until the tabletop is securely in place.

Check that all legs are firm and properly aligned before proceeding.

(x1)

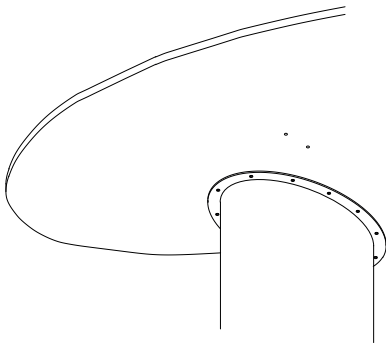
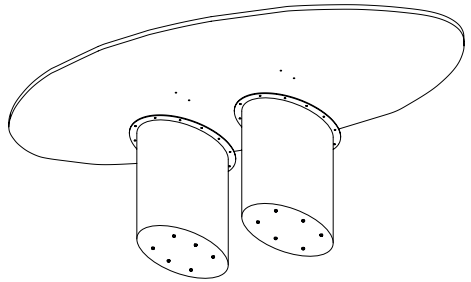
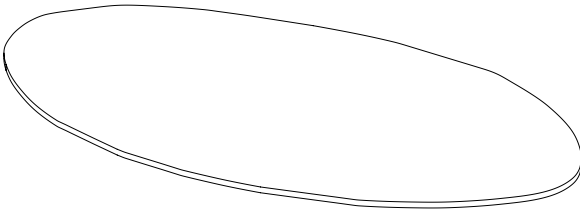

Final Securing of the Plate ⁽³⁾ to the Tabletop ⁽²⁾

From underneath, screw the plate to the tabletop using the holes in the plate as a guide. Tighten the screws until the table is firmly assembled.

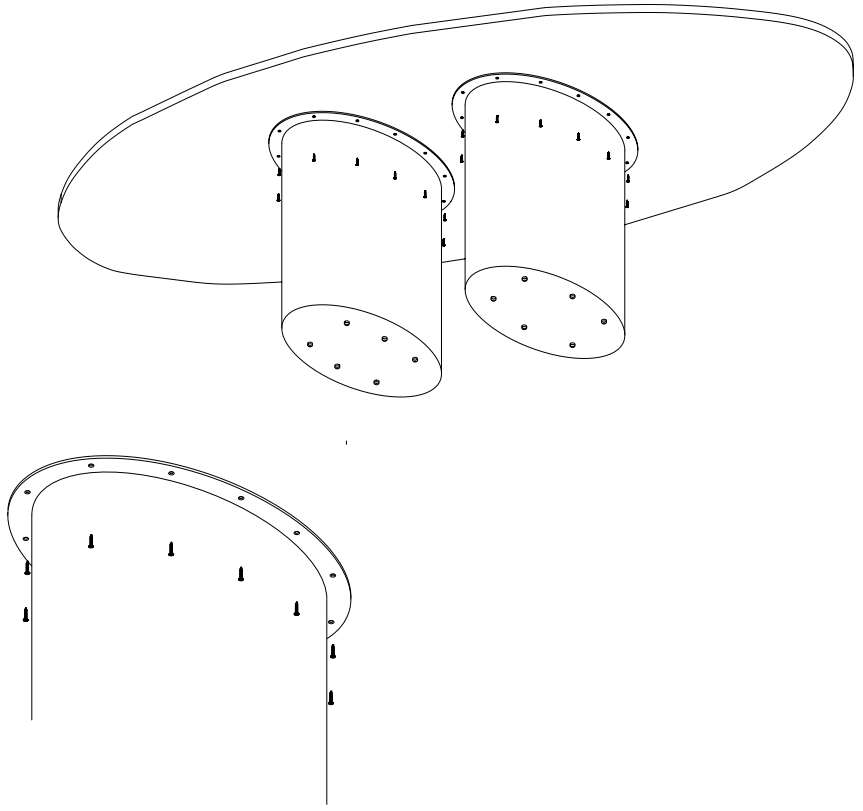

Your table is now ready to use!

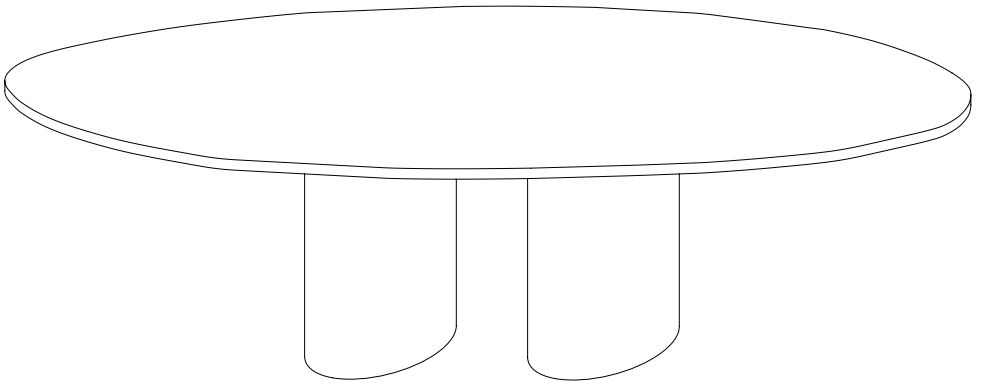

MARLOT BAUS

marlotbaus.com

[@marlotbaus](https://www.instagram.com/marlotbaus)