

Arivia C2130  
Arivia C2125

Electronic user manuals are available on the official website.  
Please go to the official website.

<https://support-kbs.katun.com>



# User's Manual

Before using the machine, please read this manual thoroughly. Be sure to keep this manual for future reference.

## Read Before Using

Before using the machine, please read "License Agreement" (terms for using the Adobe Inc. software) provided in the "Reference Guide Main Unit". Reference Guide is available on the official site of our company.

Use the software only after you agree with all applicable terms and conditions. By using the software, you are agreeing to be bound by the terms and conditions. If you do not agree to "License Agreement", please contact the dealer you purchased the product.

The manuals for this product may include descriptions about the models, features, and separately-sold accessories that are unavailable depending on the country and/or region. Contact your local representative for more information.

- This manual may not be edited, modified or copied in whole or part without the written consent of the publisher.
- Some parts of this manual are subject to change without prior notice.
- The screen shots and the illustrations in this manual are used as examples. They may differ from yours depending on the model, the software, or the OS.

© 2024 Katun Corporation. April 2024 GM1582E9-2 Edition 1

## Setup of device

### 1. Pull out the packing box upward.

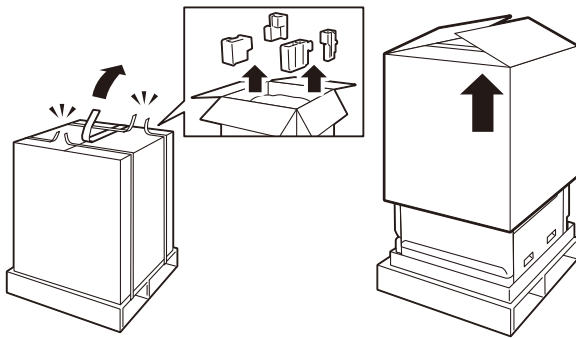

### 2. Install the device.

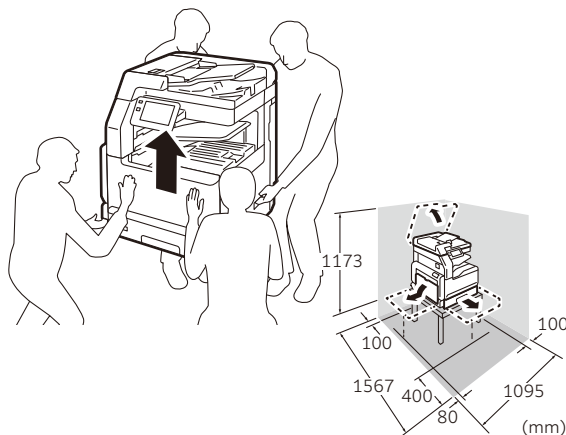

### 3. Remove the packing materials.

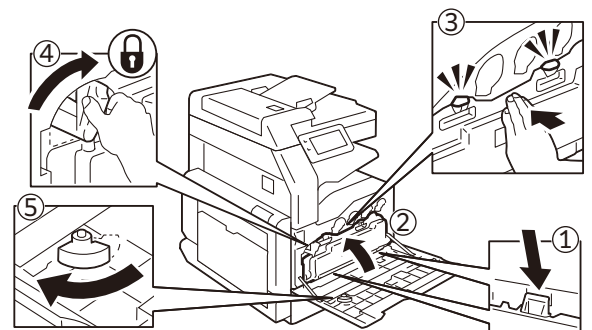
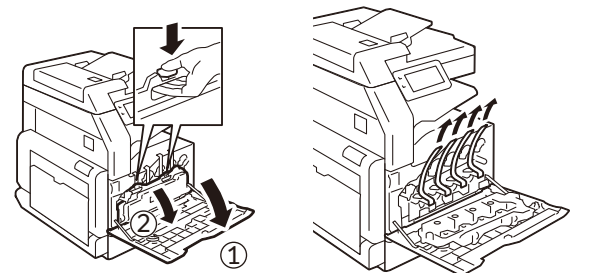
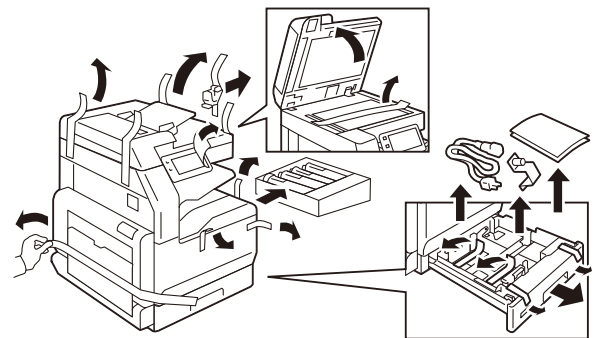

#### 4. Set the toner cartridges.

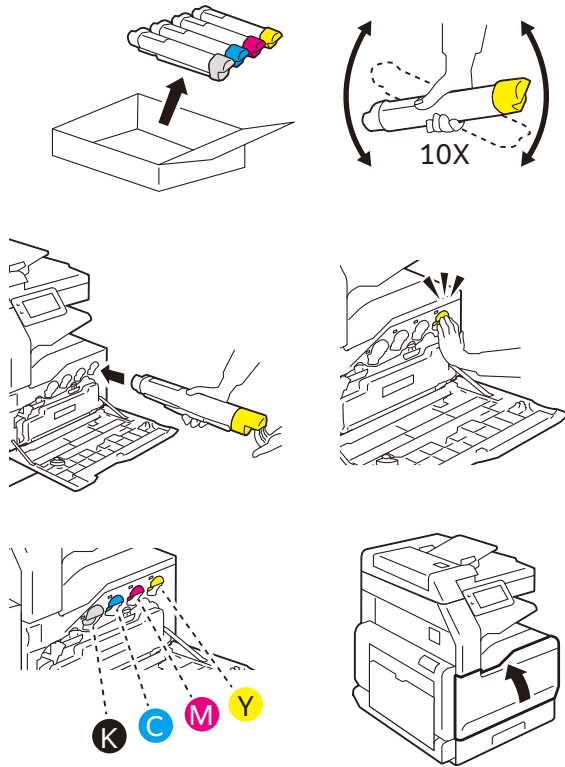

#### 5. Load papers.

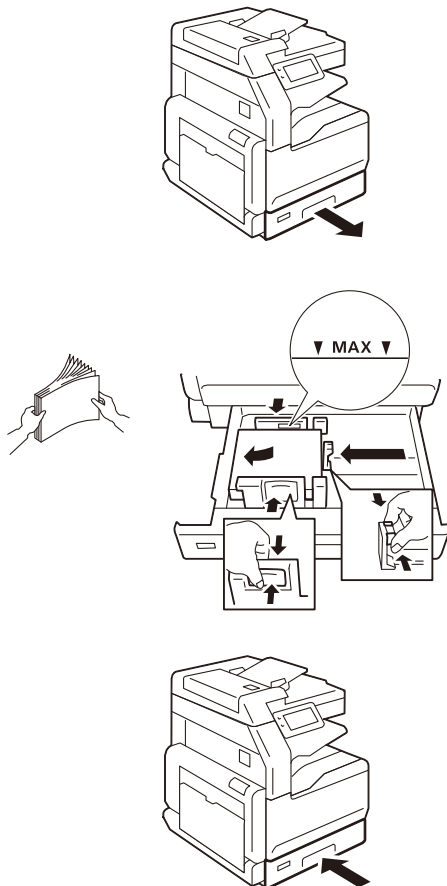

#### 6. Connect power supply.

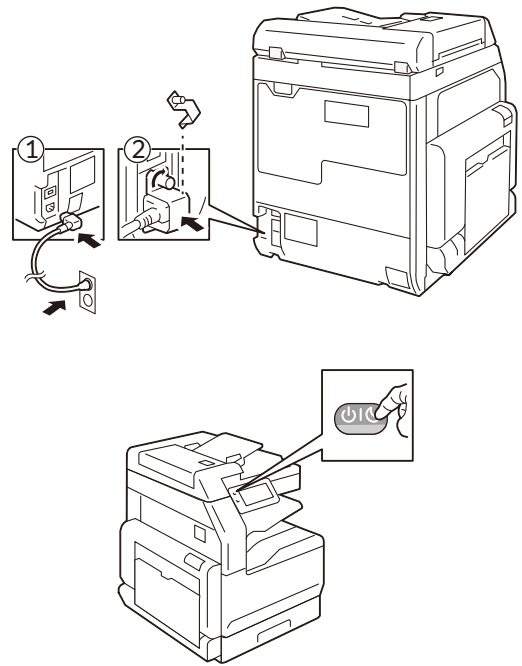

#### 7. Set [Language] > [Country/Region] according to the instructions on the screen.

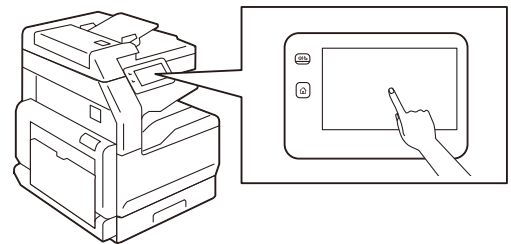

The device is restarted, and the settings are applied.

#### Note

If [Country/Region] is not correctly set, fax line connection, Wi-Fi connection, and other functions may violate the laws of the country or region. Make sure to set the correct country or region where the device is installed.

# Control Panel

## ■ Features of Control Panel

Pressing the Home button displays the Home screen.

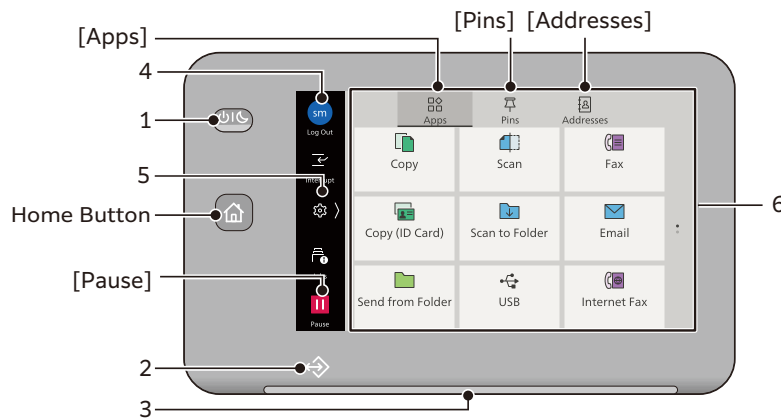

### 1. Power/Power Saving button

The power switches on.

#### Note

- When "Please wait..." is displayed, the machine is warming up. The use of machine is not available during this time.
- If the power does not switch on, confirm that the power plug is inserted.

### 2. Data indicator

This indicator blinks while data is being sent from the machine or data is being received from the client computer. Also, this indicator lights up when documents are saved in the machine or the fax is stored in a local folder.

### 3. Status display lamp

The lamp lights up in green at an instant of operation reception. When an error occurs, the lamp blinks in orange.

### 4. Login

The user is authenticated when the user enters the User ID and logs in.

When the user is logged in with the administrator rights, [Administrator] is shown in this area. While the user is authenticated, tapping it logs out the user, and the state becomes as unauthenticated.

### 5. Opening menu

Tap this to open the menu for change and check the settings of the machine.

Tap on [<] to close the menu.

### 6. Home Screen

Apps/Pins/Address Screens can be displayed.

- **[Apps]:** You can tap on any of the application icons and use its functions.
- **[Pins]:** You can execute a job again using Job Direction History and the job direction history pinned by the user with [Create Pin]. If you create a pin of the job direction history, you can also directly activate a job without opening an application.
- **[Addresses]:** You can register addresses and other information. You can activate an application from a registered address.

After activating an application, the selected address is set as the destination of the application.

## ■ Switching the Power Off

When the power is switched off, all the machine functions are stopped.

### Important

Do not switch the power off when the machine is in the following states. If the power is switched off, the data that is being processed may be deleted.

- During data reception (Data indicator is lit)
- Within 5 seconds after ejection of paper
- During copying or scanning

### 1. Press the Power/Power Saving button.

#### Note

Long pressing the Power/Power Saving button also switches off power.

### 2. Tap on [Power Off Device].

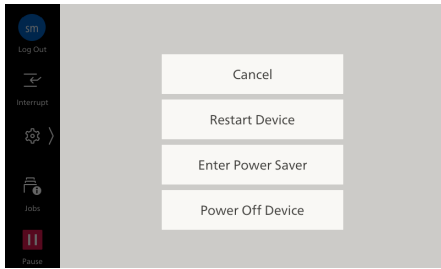

## ■ Creating Pin

If you create a pin of Job Direction History of a job that is executed in the past, you can easily execute the job with the same settings.

#### Note

- Job direction histories and created pins are managed by each user.
- Pinned job direction histories are not overwritten.
- A pin created in an Administrator mode is shared by all users.
- Change/deletion of a shared pin can be performed in an Administrator mode.

## Creating Pin of Job Direction History

### 1. Log in.

### 2. On the Home screen, tap on [Pins].

### 3. Tap on ⋮ on the right side of the history for which you want to create a pin and tap on [Create Pin].

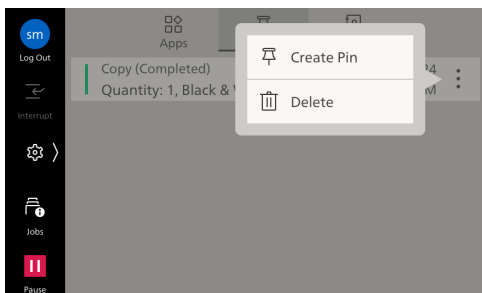

## Executing the Job from the Pinned Job Direction History

On the [Pins] screen, tap on ⋮ at the right side of the pinned job and tap on [Start Now].

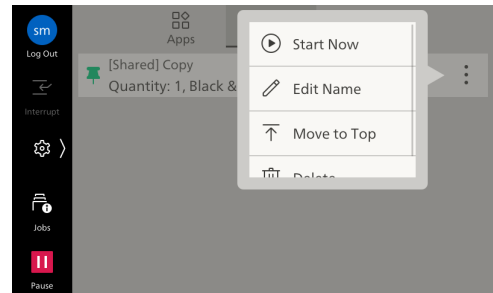

# Loading Paper

## Important

- Do not place paper or other objects in the reserved space of the tray. It may cause paper jams or machine malfunction.
- While the printer is processing a job, do not remove the Paper Tray used for the job.

## Note

Before loading the paper into the Paper Tray, fan a stack of paper well. This will separate the sheets, and it can prevent paper jamming.

This section explains how to load the plain paper into the Trays 1 to 4.

## Loadable Paper

Paper size (mm)	Width: 140 to 297, Length: 182 to 432
Paper weight (g/m <sup>2</sup> )	60 to 256

## Note

When you use a Tandem Tray module, the size of paper that can be loaded in Trays 3 and 4 is different.

### 1. Pull out the Paper Tray until it stops.

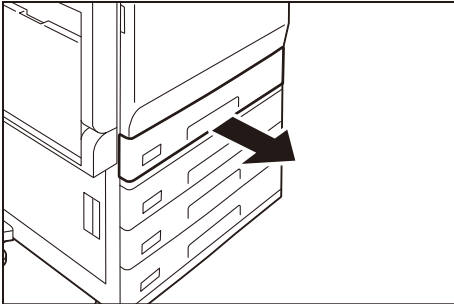

### 2. When paper is already loaded in the tray, take out the paper.

### 3. Pinch the two guide clips, and adjust to the correct paper size.

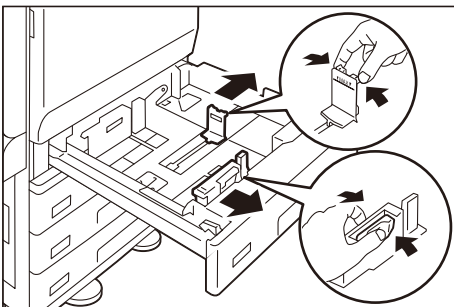

### 4. Fan a stack of paper, face the print surface up, and then load the paper with edges aligned according to the direction of the arrow.

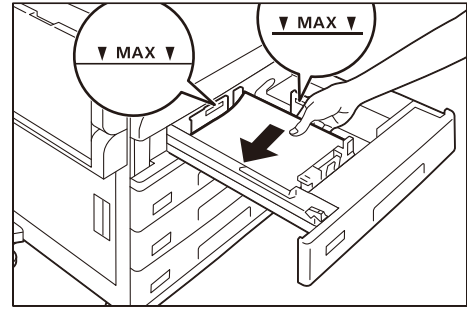

## Important

Do not load paper above the maximum fill line. It may cause paper jams or machine malfunction.

## Note

Adjust the guide correctly to the size of paper. If the guide is not adjusted correctly, the machine cannot feed the paper properly, resulting in paper jams.

### 5. Push in the Paper Tray.

### 6. When you have changed the paper type, set the Paper Tray on the Device screen.

#### 1. Tap on > [Device] > [Paper Tray Settings].

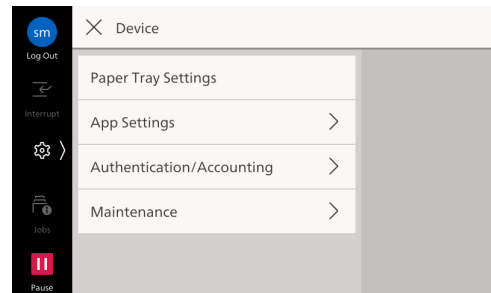

#### 2. After tapping on the number for the Paper Tray you have loaded the paper, configure the paper items, and then tap on [OK].

### 7. When printing, configure the paper settings from the printer driver.

# Copy/Fax/Scan

## 1. Set the document.



### Document Feeder

#### Loadable paper

Paper size (mm)	Width	49 to 297
	Length	85 to 432
Paper weight (g/m <sup>2</sup> )	Single side printing	38 to 128
	Double side printing	50 to 128

#### Note

- When the Fax Kit is installed, the loadable paper size is up to 600 mm in length.

- Open the Document Cover.
- Wipe off any dirt adhering to the glass strip and white plastic area located in the left side of the Document Glass.

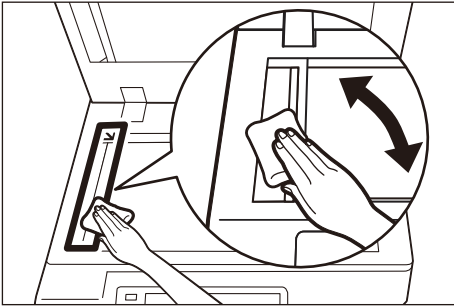

- Close the Document Cover.
- Confirm that the document is free of tag paper, adhesive tape, staples, and clips, and stretch out the document if it is wrinkled or folded.
- Align the upper left corner of the document so that the original size is correctly detected.
- Load the document face up (when the document is 2-sided, place the front side up) in the center of Document Feeder.

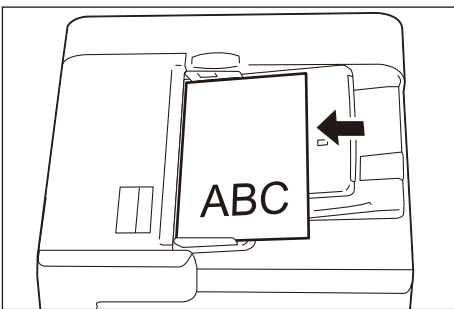

#### Important

Do not set documents above the maximum fill line. It may cause paper jams or machine malfunction.

### Document Glass

#### Loadable paper

Paper size (mm)	Width: Up to 297, Length: Up to 432
-----------------	-------------------------------------

- Open the Document Cover, and wipe off any dirt from the Document Glass.

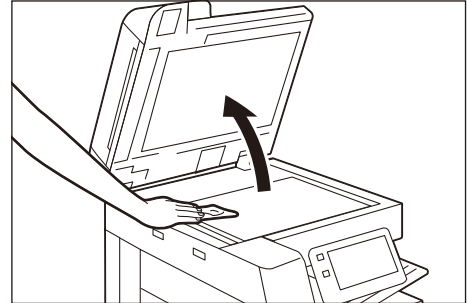

- Load the document face down with the document aligned with the upper left corner of the Document Glass.

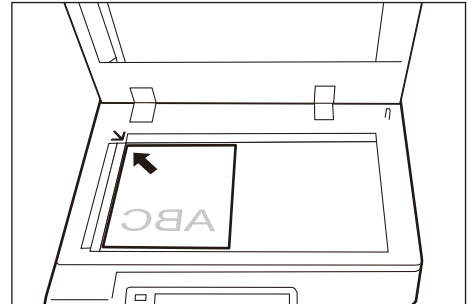

- Close the Document Cover.

- Move the document guide to align with both edges of the document.

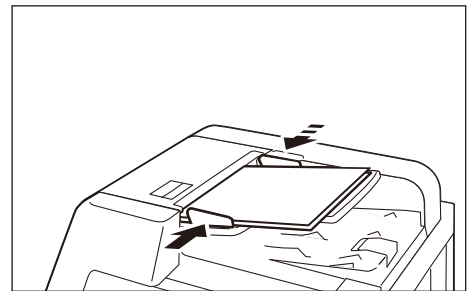

- Open the Document Stopper.

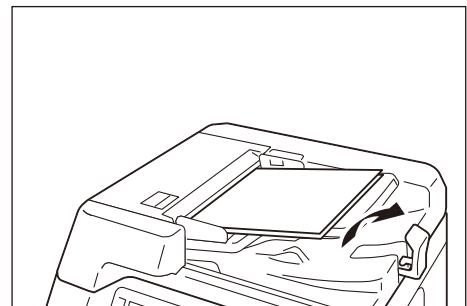

2. On the [Apps] screen, tap on the desired Application icon.

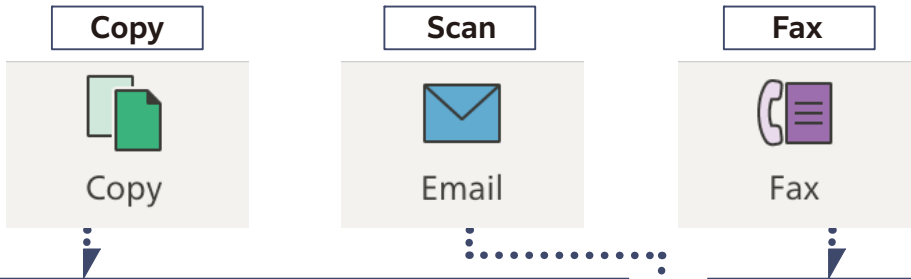

### Copy

- As needed, configure the setting items.

- Tap on [Start].

### Fax

- Enter by the keyboard or by tapping on the Address Book (👤) or Redial (🔄) to specify the recipient.

- Tap on [Done] or [OK].
- Tap on ⚙️ and configure the setting items as needed.
- Tap on [Start].

### Scan (Email)

**Note**

- [Scan to Folder], [Scan], [USB], and [Scan to Desktop] are also available as methods for scanning.
- To send an e-mail, the e-mail settings need to be configured in the Device beforehand.

- Specify the recipient by directly entering using the keyboard or by tapping on the Address Book (👤).

**Note**

- When specifying multiple recipients by directly entering using the keyboard, tap on [Add Recipient], and then enter the recipient.
- To change the recipient type (To/Cc/Bcc), tap on To.

- Tap on [Done] or [OK].

- Tap on ⚙️ and configure the setting items as needed.

- Tap on [Start].

# Safety Notes



























Before using this product, read "Safety Notes" carefully for safety use.

This product and recommended supplies have been tested and found to comply with strict safety requirements including safety agency approvals and compliance with environmental standards. Follow the following instructions for safety use.

## ⚠ WARNING

Any unauthorized alteration including an addition of new functions or connection to external devices may not be covered by this product warranty. Contact your local representative for more information.

Follow all warning instructions marked on this product. The warning marks stand for the followings:

 <b>DANGER</b>	Used for item that if not followed strictly, can lead death or severe or fatal injuries and the possibility to do it is comparatively high.
 <b>WARNING</b>	Used for items that if not followed strictly, can lead to severe or fatal injuries.
 <b>CAUTION</b>	Used for items that if not followed strictly, can cause injuries to user or damages to machine.
<p>: A symbol for items to pay attention to when handling machine. Follow instructions carefully to use machine safely.</p>	
<p>  Caution               Caution for electrostatic breakage               Flammable               Explodable               Electric shock               Heated surface         </p>	
<p>  Moving object               Pinched fingers               Rotating Parts Hazard         </p>	
<p> Sharp Edge Hazard</p>	
<p>: A symbol for prohibited items. Follow instructions carefully to avoid any dangerous acts.</p>	
<p>  Prohibited               No fire               Do not touch               Do not use in bathroom         </p>	
<p>  Do not tear down               Keep away from wet               Never touch with wet hand         </p>	
<p>: A symbol for items that must be performed. Follow instructions carefully to carry out these essential tasks.</p>	
<p>  Instructions               Unplug               Ground/Earth         </p>	

## ■ Electrical Safety

### ⚠ WARNING

This product shall be operated by the power source as indicated on this product's data plate label. Consult your local power company to check if your power source meets the requirements.



**WARNING:** Connect this product to a protective earth circuit.

This product is supplied with a plug that has a protective earth pin. The plug fits only into an earthed electrical outlet. This is a safety feature. If the plug doesn't fit to the outlet, contact an electrician to replace the outlet to avoid risk of electric shock. Never use an earthed adapter plug to connect the product to the electrical outlet that has no earth connection terminal. Improper connection of a grounding conductor may cause electric shock.



Plug the power cord directly into a grounded electrical outlet. To prevent overheat and a fire accident, do not use an extension cord, a multi-plug adaptor or a multiple connector. Consult your local representative to check if an outlet is grounded.



Connect this product to a branch circuit or an outlet that has larger capacity than the rated ampere and voltage of this product. See the data plate on the rear panel of this product for its rated ampere and voltage.



Never touch the power cord with wet hands. It may cause electric shock.



Do not put an object on the power cord.



Always keep the plug connection free of dust. The dusty and damp environment may bring about minute electric current in a connector. It may generate heat and eventually cause a fire accident.



To avoid the risk of electric shock and a fire accident, only use the power cord supplied with this product or the ones designated by our company. The power cord is exclusive use for this product. Do not use it for any other product. Do not damage or alter the power cord. Damage and alteration may generate heat and eventually cause electric shock or a fire accident. If the power cord is damaged or insulated wires are exposed, contact your local representative for its replacement. Do not use a damaged or uninsulated cord to avoid the risk of electric shock and a fire accident.

### ⚠ CAUTION



Unplug this product to turn off power completely. Install this product near an outlet to easily unplug it in case of emergency.



When cleaning this product, always switch off and unplug it. Access to a live product interior may cause electric shock.



Do not unplug or re-plug this product with the switch on. Plugging and unplugging a live connector may deform the plug and generate heat, and eventually cause a fire accident.



Hold the plug not the cord when unplugging this product, or it may damage the cord and cause electric shock or a fire accident.



Always switch off and unplug this product when it (i.e., fax function) is not used over weekends or long holidays. Please note that it cannot receive fax message during switch-off.



Once a month, switch off this product and check if

- the power cord is plugged firmly into an electrical outlet;
- the plug is not excessively heated, rusted or bent;
- the plug and electrical outlet are free of dust; and
- the power cord is not cracked or worn down.

Once you notice any unusual condition, switch off and unplug this product first and contact your local representative.



## ■ Product Installation

### ⚠ WARNING

! Do not locate this product where people might step on or trip over the power cord. Friction or excessive pressure may generate heat and eventually cause electric shock or a fire accident.

### ⚠ CAUTION

⊘ Never locate this product in the following places:

- Near radiators or any other heat sources
- Near volatile flammable materials such as curtains
- In the hot, humid, dusty or poorly ventilated environment
- In the place receiving direct sunlight
- Near cookers or humidifiers

⊘ Keep away the packing materials of product from small children. The thin film may cling to nose and mouth and prevent breathing.

! This product weighs 70 kg. When moving it, always carry it by a team of four or more persons to avoid mishandling or injury.

! When lifting this product, place the hand on the front panel and firmly grip the handholds provided on the right side, the stepped portion on the left side, and the recessed portion on the underside of the product. Never lift it by gripping any other areas. It will prevent you from dropping this product and getting back ache or injuries.

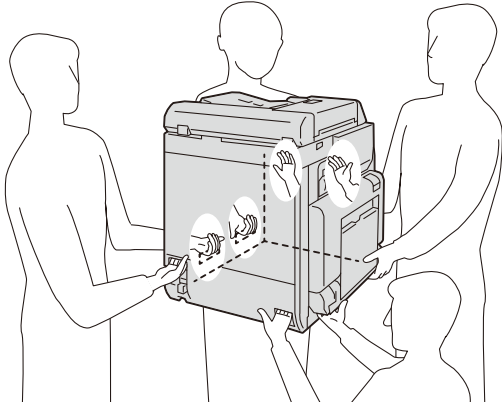

! Locate this product on a level and sturdy surface that can withstand a weight of 68 kg (minimum configuration). Otherwise, if tilted, this product may fall over and cause injuries.

! Locate this product in a well-ventilated area. Do not obstruct ventilation openings of this product. Keep the minimum clearance as follows for ventilation and an access to the power plug. Unplug this product if an abnormal condition is noted.

## Minimum configuration

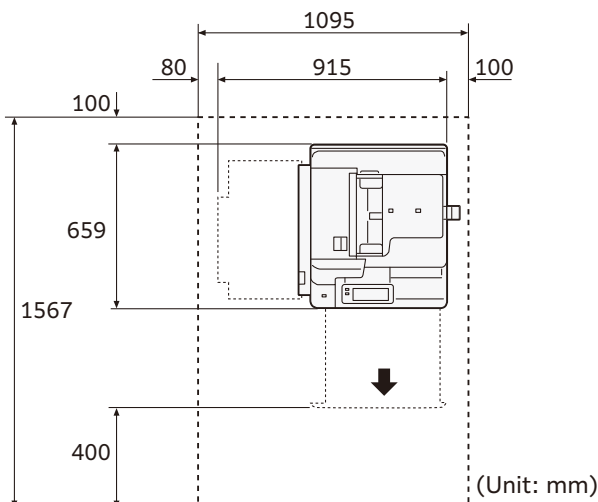

! Do not incline this product at more than 10° angle. Otherwise, it may fall over and cause injuries.

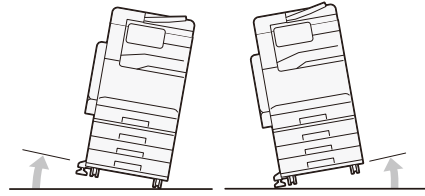

! Always lock the wheels of this product after installation. Otherwise, it may fall over or slide and cause injuries.

! To bundle wires and cables, always use the cable ties and spiral tubes that our company supplies. Otherwise, it may cause some defects.

## ■ Operational Safety

### ⚠ WARNING

⊘ The operator's product maintenance procedures are described in the manuals supplied with this product. Do not carry out any other maintenance procedures not described in the manuals.

⊘ This product features safety design not to allow operators access to hazard areas. The hazard areas are isolated from operators by covers or protectors which require a tool to remove. To prevent electric shock and injuries, never remove those covers and protectors.

⚡ To avoid the risk of electric shock and a fire accident, switch off and unplug this product promptly in the following conditions, then contact your local representative.

- This product emits smoke or its surface is unusually hot.
- This product emits unusual noise or odor.
- The power cord is cracked or worn down.
- A circuit breaker, fuse or any other safety device becomes activated.
- Any liquid is spilled into this product.
- This product is soaked in water.
- Any part of this product is damaged.

⊘ Do not insert any object into slots or openings of this product. Do not put any of the followings on this product:

- Liquid container such as flower vases or coffee cups
- Metal parts such as staples or clips
- Heavy objects

If liquid is spilled over or metal parts are slipped into this product, it may cause electric shock or a fire accident.

⊘ Do not use conductive paper such as origami paper, carbonic paper, conductively-coated paper or conductive ink preprinted paper. When paper jam occurs, it may cause short-circuit and eventually a fire accident.

⊘ When cleaning this product, use the designated cleaning materials exclusive to it. Other cleaning materials may result in poor performance of this product. Never use aerosol cleaners to avoid catching fire and explosion.

⚠ Do not pull out two or more paper trays at a time. If somebody accidentally pushes this product with multiple trays open, it may incline and fall over. This may cause injuries. When you need to open paper trays, do it one after the other.

⚠ If you need to pull out a tray to remove paper jam, contact your local representative. Do not pull out a tray, otherwise it may cause injuries.



⊘ When you play the media (e.g., CD-ROM, DVD) supplied with this product, always use said media-enabled device. Otherwise, large sound may damage its speakers or your ears.



 **CAUTION**

 Always follow all warning instructions marked on or supplied with this product. To avoid the risk of burn injuries and electric shock, never touch the area with the "Heated surface" or "Electric shock" marks on.

 Keep electrical and mechanical safety interlocks active. Keep the safety interlocks away from magnetic materials. Magnetic materials may accidentally activate this product and cause injuries or electric shock.

 Do not attempt to remove a paper deeply jammed inside this product, particularly a paper wrapped around the fusing unit or the heat roller. Otherwise, it may cause injuries or burns. Switch off this product immediately and contact your local representative.

  Never touch the paper output area of the finisher during operation. It may cause injuries.

  Be careful in removing jammed staples.

 Be careful not to get injured by waste staples when detaching a staple waste container.

 Waste staples may come out with output paper. Be careful not to get injured by the staples.

 Never touch safety interlocks. When a front cover is open, safety interlocks become activated to stop this product. Do not apply pressure on safety interlocks with a coin or screwdriver. Otherwise, this product may become activated and cause injuries.

 Do not staple punched holes of paper. Sharp points of a staple may cause injuries.

 Do not apply excessive force to hold thick document on the document glass. It may break the glass and cause injuries.

 **Fusing Unit Safety**  
When removing the Fusing Unit, always switch off first and wait for 40 minutes until it cools off.

 **Fusing Unit Safety**  
Do not dismantle the Fusing Unit. When removing paper jam from the Fusing Unit, contact your local representative. Otherwise, it may cause injuries.

 **USA only**  
To reduce the risk of fire, use only No. 26 American Wire Gauge (AWG) or larger telecommunication line cord.

 Ventilate well during extended operation or mass copying or printing. It may affect the office air environment due to odor such as ozone in a poorly ventilated room.

Provide proper ventilation to ensure the comfortable and safe environment.

## ■ Regulation

### Radio Frequency Emissions (Class B digital device) (USA)

Note: This equipment has been tested and found to comply with the limits for a Class B digital device, pursuant to Part 15 of the FCC Rules. These limits are designed to provide reasonable protection against harmful interference in a residential installation. This equipment generates, uses and can radiate radio frequency energy and, if not installed and used in accordance with the instructions, may cause harmful interference to radio communications. However, there is no guarantee that interference will not occur in a particular installation. If this equipment does cause harmful interference to radio or television reception, which can be determined by turning the equipment off and on, the user is encouraged to try to correct the interference by one or more of the following measures:

- Reorient or relocate the receiving antenna.
- Increase the separation between the equipment and receiver.
- Connect the equipment into an outlet on a circuit different from that to which the receiver is connected.
- Consult the dealer or an experienced radio/TV technician for help.

Changes or modifications to this equipment not specifically approved by our company may void the user's authority to operate this equipment.

- This device complies with Part 15 of the FCC Rules. Operation is subject to the following two conditions: (1) This device may not cause harmful interference, and (2) this device must accept any interference received, including interference that may cause undesired operation.

Contact: Katun Corporation  
Phone: +1-800-328-2965  
Address: 7760 France Ave. S. Suite 340, Minneapolis, MN 55435, U.S.A.

For UK

Hereby, we declare this product is in compliance with Product Security and Telecommunications Infrastructure Act 2022.

The full text of the statement of compliance is available at the following internet address: <https://support-kbs.katun.com>

 Shielded cables must be used with this equipment to maintain compliance with Council Directive 2014/30/EU

## ■ Environment

### Disposal of Electrical and Electronic Equipment in Professional/Business Equipment (European Union and UK)



This symbol on this product, or in the manual and in the warranty, and/or on its packaging indicates that this product shall not be treated as household waste. Instead it should be disposed in compliance with agreed national procedures.

By ensuring this product is disposed of correctly, you will help prevent potential negative consequences to the environment and human health, which could otherwise be caused by inappropriate waste handling of this product. Please contact your local representative prior to disposal.



This symbol on the batteries or accumulators indicates that those batteries shall not be treated as household waste.

If your equipment contains easy removal batteries or accumulators, please dispose these separately according to your local requirements.

The recycling of materials will help to conserve natural resources. For more detailed information about recycling this product, please contact your local authorities and ask for the correct way of disposal.

USA only

Perchlorate Material - special handling may apply.

See [www.dtsc.ca.gov/hazardouswaste/perchlorate](http://www.dtsc.ca.gov/hazardouswaste/perchlorate).

