

**QUICK
DELIVERY**

QD



NATIONAL

CONTENTS

04	FINISH+ FABRIC OPTIONS	40	OPEN PLAN WORKSTATIONS
06	LOUNGE SEATING	42	RECEPTION WORKSTATIONS
10	PILLOWS+ IMPROMPTU SEATING	44	ACCESSORIES
11	GUEST SEATING	49	FILING+ STORAGE
19	STOOLS	50	COLLABORATIVE TABLES
23	BEAM SEATING	52	CONFERENCE+ OFFICE TABLES
24	TASK SEATING	53	OCCASIONAL TABLES
29	CONFERENCE+ EXECUTIVE SEATING	55	GENERAL INFORMATION + WARRANTY
30	DESKS+ WORKSTATIONS		

QUICK DELIVERY PRODUCTS IN 10 DAYS OR LESS.

**COMPLETE SOLUTIONS. NO UPCHARGE.
A SPECTRUM OF SURFACE MATERIALS.
ENDLESS POSSIBILITIES.**

Our robust quick delivery program offers a wide variety of product solutions to outfit any space and coordinate with any style, all at no upcharge. From private office and open plan areas to reception and collaborative spaces, our complete portfolio of Quick Delivery solutions has all of the products you need.

When it is essential to get task seating even quicker, we offer Laudio™, Vora™, and Whirl™ seating models that ship within 2 days. This expedited process offers you even quicker solutions when you are in need.

Quickly create beautiful spaces that boost productivity, add storage, and increase functionality. Offer welcoming and comfortable spaces for your employees and your guests. National's Quick Delivery program gets solutions in your space quickly and without compromise.

Quick Delivery quantity not to exceed 10 offices, 20 chairs, and 5 lounge chairs.



SEATING FINISHES



TFL LAMINATES

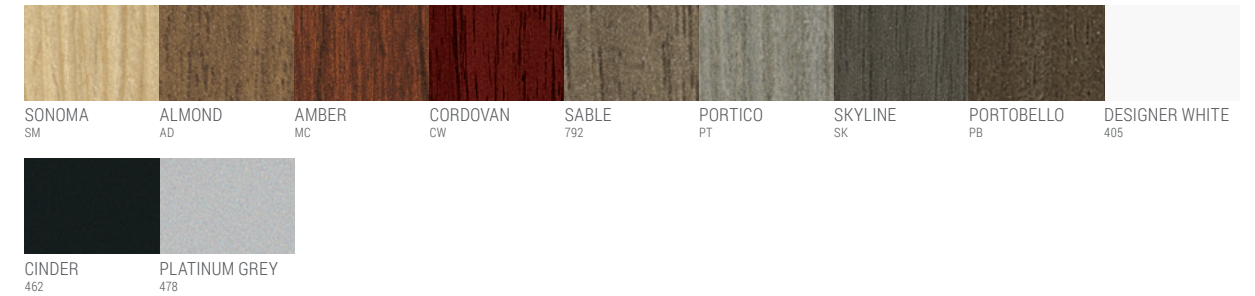

CASEGOOD FINISHES

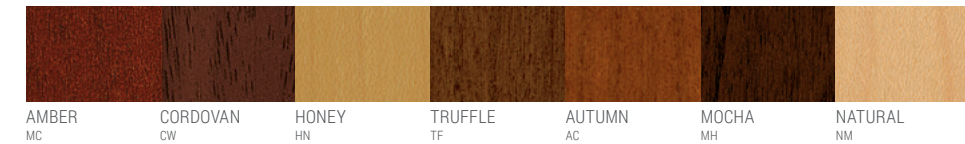

METAL LEG+BASE FINISHES



UPHOLSTERY PATTERNS ALL COLORS AVAILABLE

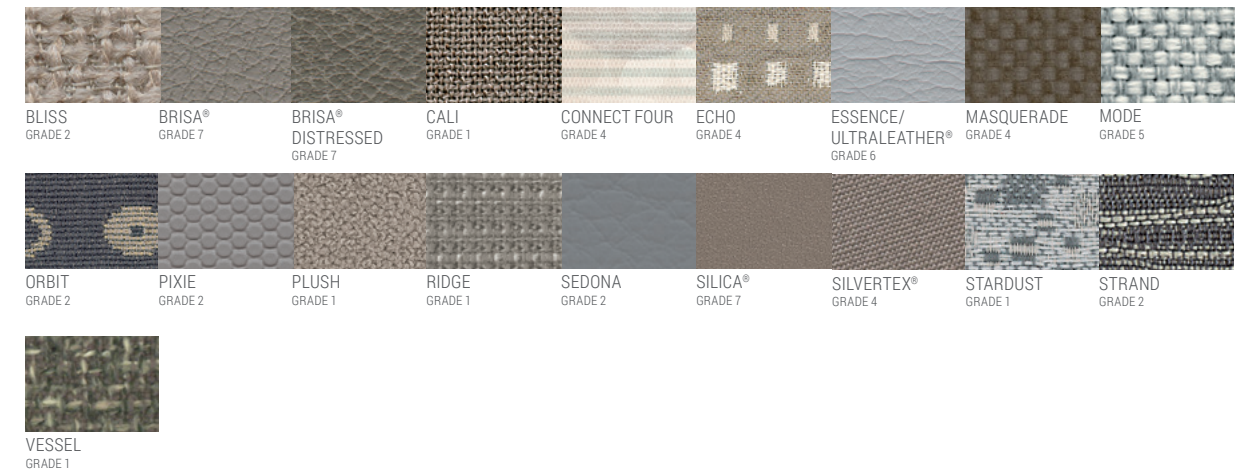

PLASTIC OPTIONS LISTED WITH EACH SEATING PRODUCT

*Toss pillows with button are not included in Quick Delivery

LOUNGE SEATING

TELLARO® LOUNGE

- One seat
- Upholstered arm
- Upholstered leg

ONE SEAT
QN74M1A



COLLETTE® LOUNGE

- One, two, and three seat
- Upholstered back
- Arm and armless
- Top stitch french seam with matching or contrasting thread
- Wood legs available in 19 wood finishes
- Metal legs available in cinder or platinum metallic

ONE SEAT
QN84L1M (ARMLESS)
QN84L1A (ARMS)

TWO SEAT
QN84L2M (ARMLESS)²
QN84L2A (ARMS)

THREE SEAT
QN84L3M (ARMLESS)
QN84L3A (ARMS)

OTTOMAN
QN84D1 (SMALL)
QN84D2 (LARGE)

GANGING KIT
N84GK
N84GKL (WITH LEG)

LEG OPTIONS



WOOD

METAL



²Toss pillows available in Quick Delivery fabrics.

ALL PRICES ARE LIST PRICE

CONFIDE® LOUNGE

- One seat
- Upholstered back
- Easy clean out feature
- Waterfall seat edge
- Steel frame
- Wall saver leg design
- No arm cap, wood cap in 19 finishes or black urethane
- Leg colors available in cinder and platinum metallic

GUEST
QN78LAU



FARRAH® LOUNGE

- One seat
- Arm and armless
- Cinder, platinum metallic, or polished aluminum base

LOUNGE
QN71M1M (ARMLESS)
QN71M1A (ARMS)

BENCH
QN71D1



MONTERREY™ LOUNGE

- One seat
- Removable seat cushions
- Wood frame
- Wood base available in 19 wood finishes

ONE SEAT
QN90AA





SWIFT™ LOUNGE

- One seat
- Arm and armless
- Mobile one seat lounge option
 - Wood available in 19 wood finishes
 - Metal available in cinder and platinum metallic
- Metal base with wood accent
- Ganging kit

ONE SEAT LOUNGE, ARMS
 QN95AA (STATIC)
 QN95AAC (MOBILE)

ONE SEAT LOUNGE, ARMLESS
 QN95MA (STATIC)
 QN95MAC (MOBILE)

ONE SEAT BENCH
 QN95DD (STATIC)
 QN95DDC (MOBILE)

GANGING KIT
 N95TT (PACK 20)
 N95TR (BLACK METAL)



FRINGE® CLUB

- One seat
- Arm and armless
- 5-prong aluminum base available in cinder or platinum metallic
- Static and mobile models
- Auto-return swivel on static models

CLUB CHAIR, ARMS
 QN93CSA (STATIC)
 QN93CSAC (MOBILE)

CLUB CHAIR, ARMLESS
 QN93CSM (STATIC)
 QN93CSMC (MOBILE)



ELOQUENCE® LOUNGE

- One seat
- Upholstered arm panels
- Wood frame
- Tapered wood legs
- Optional soft black arm caps
- Wood frame available in 19 wood finishes

ONE SEAT LOUNGE
 QN85LA (NO ARM CAPS)
 QN85LAT (POLYURETHANE ARM CAPS)



RENO® LOUNGE

- One seat
- Standard sized
- Upholstered arm
- Wood available in 19 wood finishes
- Metal available in cinder, platinum metallic, and satin nickel

ONE SEAT LOUNGE, METAL LEGS
 QN32AAM

ONE SEAT LOUNGE, WOOD LEGS
 QN32AAW

LEG OPTIONS



GRIN® LOUNGE

- One seat
- Armless
- Sled base available in cinder or polished
- 4-prong low profile polished aluminum base with auto return on lounge
- Horizontal stitch options

SLED BASE
 QN49GMD1
 QN49GMND1 (NO STITCH, NO PIPING)

4-PRONG LOW PROFILE
 QN49GMS1
 QN49GMNS1 (NO STITCH, NO PIPING)

4-PRONG LOW PROFILE – MOBILE
 QN49GMSC1
 QN49GMNSC1 (NO STITCH, NO PIPING)

*Grin guest and stools also available in Quick Delivery.

MABEL® LOUNGE

- One seat
- Low and mid back options
- Armless
- 4-prong high profile and low profile polished aluminum base

LOW BACK LOUNGE
 QN77GL4LM (LOW PROFILE)
 QN77GL4HM (HIGH PROFILE)

MID BACK LOUNGE
 QN77GM4LM (LOW PROFILE)
 QN77GM4HM (HIGH PROFILE)

OTTOMAN
 QN77D14LM (LOW PROFILE)



PILLOWS+IMPROMPTU SEATING



TOSS™

- Pillows are available in both classic and relax fill
- 3 shapes: square, rectangle, and bolster

SQUARE PILLOW

QN10PSQ1414 (14" X 14")
QN10PSQ1616 (16" X 16")
QN10PSQ1818 (18" X 18")

RECTANGLE PILLOW

QN10PRT1508 (15" X 8")

BOLSTER

QN10PBL1806 (18" X 6")

WHIMSY®

- Fully upholstered
- 3 sizes: 16", 18", and 22"
- Mobile and static models
- Round models are available with leather pulls

ROUND – STATIC

QN66RD16G (16")
QN66RD18G (18")
QN66RD22G (22")

ROUND – MOBILE

QN66RD16C (16")
QN66RD18C (18")
QN66RD22C (22")

SQUARE – STATIC

QN66SQ16G (16" X 16")
QN66SQ18G (18" X 18")
QN66SQ22G (22" X 22")

SQUARE – MOBILE

QN66SQ16C (16" X 16")
QN66SQ18C (18" X 18")
QN66SQ22C (22" X 22")



ALL PRICES ARE LIST PRICE

GUEST SEATING



DITTO™ STACKER

- Plastic shell with vented back
- Armless
- Polished steel sled base
- Clear nylon glides; felt glide option
- Optional transport dolly
- Stacks 8 high on floor; 25 high on transport dolly

STACKING CHAIR ARMLESS

QN36GM
QN36G4M (PKG. 4)

*Ditto counter and bar stools also available in Quick Delivery

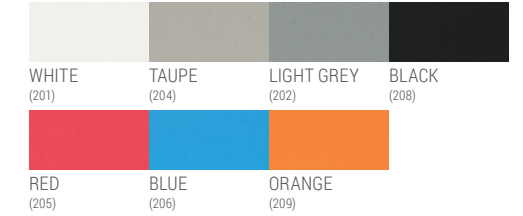

JEWEL™ STACKER

- Wood shell with cutout handle
- Arm and armless
- Ganging options
- Available in 5 finishes
- Polished tubular steel frame
- Stacks 4 high

STACKER

N44GMTW__ (ARMLESS)
N44GATW__ (ARMS)

GANGING BRACKET

N44GB (PKG. 5 PAIRS)

*Jewel bar stool also available in Quick Delivery

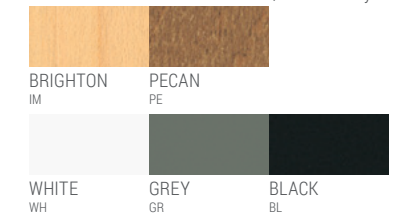

TAG® STACKER

- Upholstered back
- Arc or square back
- Arm and armless
- Cinder or platinum metallic steel frame
- Hard or soft glides
- Optional wall saver leg design
- Optional transport dolly
- Stacks 6 high

STACKER ARC BACK

QN60BB (ARMLESS)
QN60AA (ARMS)
QN60SBB (WALL SAVER, ARMLESS)
QN60SAA (WALL SAVER, ARMS)

STACKER SQUARE BACK

QN60DD (ARMLESS)
QN60CC (ARMS)
QN60SDD (WALL SAVER, ARMLESS)
QN60SCC (WALL SAVER, ARMS)

GANGING BRACKET

QN60GB

GUEST SEATING



JIMINY® NESTING CHAIRS

- Black mesh or upholstered back
- Seat flips to nest chairs for storage
- Arm and armless
- Polished aluminum frame connectors
- Cinder or platinum metallic steel frame
- Static or mobile options

NESTING CHAIR MOBILE

- QN52GHMC (ARMLESS)
- QN52GHAC (ARMS)
- QN52GUMC (UPHOLSTERED ARMLESS)
- QN52GUAC (UPHOLSTERED ARMS)

NESTING CHAIR STATIC

- QN52GHM (ARMLESS)
- QN52GHA (ARMS)
- QN52GUM (UPHOLSTERED ARMLESS)
- QN52GUA (UPHOLSTERED ARMS)

LAVORO® GUEST

- Black mesh or upholstered back
- Arm and armless
- Black arms
- Upholstered or plastic seat
- Easy clean out feature
- Tubular steel frame in black or polished aluminum
- Static and mobile options
- All models available

MESH BACK, UPHOLSTERED SEAT, ARMS

- QN30GM9UP (STATIC)
- QN30GM9UPC (MOBILE)

UPHOLSTERED BACK, UPHOLSTERED SEAT, ARMS

- QN30GP9UP (STATIC)
- QN30GP9UPC (MOBILE)

FULLY UPHOLSTERED BACK, UPHOLSTERED SEAT, ARMS

- QN30GU9UP (STATIC)
- QN30GU9UPC (MOBILE)

*Lavoro task also available in Quick Delivery



MODELS SHOWN: QN30GU9UP, QN30GM9UN

ALL PRICES ARE LIST PRICE



CINCH® STACKER

- Plastic back and seat
- Upholstered seat option
- Steel frame
- Static or mobile options
- Arm, tablet arm, or armless
- Standard tablet arm and oversized tablet arm options
- Ganging options
- Optional contrasting plastic
- Optional bookrack
- Optional transport dolly
- Stacks 15 high on floor; 12 high on transport dolly

STACKING CHAIR ARMLESS

- QN45APR
- QN45AP (PKG. 4)
- QN45AUR (UPHL. SEAT)
- QN45AU (UPHL. SEAT) (PKG. 4)

STACKING CHAIR ARMLESS, MOBILE

- QN45BPR
- QN45BP (PKG. 4)
- QN45BUR (UPHL. SEAT)
- QN45BU (UPHL. SEAT) (PKG. 4)

STANDARD TABLET ARM

- QN45RTR (RIGHT-HANDED)
- QN45RT (RIGHT-HANDED) (PKG. 4)
- QN45LTR (LEFT-HANDED)
- QN45LT (LEFT-HANDED) (PKG. 4)

OVERSIZED TABLET ARM

- QN45RT2R (RIGHT-HANDED)
- QN45RT2 (RIGHT-HANDED) (PKG. 4)
- SSQN45LT2R (LEFT-HANDED)
- QN45LT2 (LEFT-HANDED) (PKG. 4)

PLATINUM METALLIC ARMS

- QN45MAR (1 PAIR)
- QN45MA (PKG. 4 PAIRS)

CINDER ARMS

- QN45MMR (1 PAIR)
- QN45MM (PKG. 4 PAIRS)

BOOKRACK

- QN45BKR
- QN45BK (PKG. 4)

GANGING BRACKET

- QN45GB (PKG. 20)

TRANSPORT DOLLY

- QN45TD

*Cinch counter, bar, and task stools, and stacker and beam seating also available in Quick Delivery.

PLASTIC COLORS

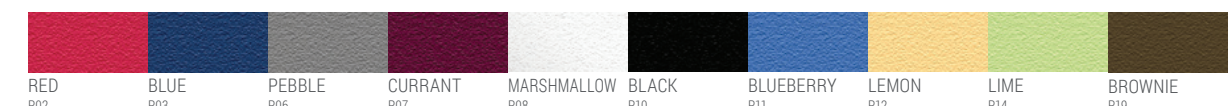

RED P02 BLUE P03 PEBBLE P06 CURRANT P07 MARSHMALLOW P08 BLACK P10 BLUEBERRY P11 LEMON P12 LIME P14 BROWNIE P19



TIZELLE™ GUEST

- Upholstered back
- Arm and armless
- Wood frame
- Wall saver leg design

GUEST
 QN51GFM (ARMLESS)
 QN49GUNW (ARMS)



VOLUTE® SEATING COLLECTION

- Mid back plastic shell
- 5 plastic colors
- Multiple base options available
- Base available in black, polished aluminum, or all wood seating finishes
- Height adjustable
- Optional open casters or soft casters

4-PRONG, STATIC
 QN46GP4HM (HIGH PROFILE)
 QN46GP4LM (LOW PROFILE)

4-PRONG, MOBILE
 QN46GP4HMC (HIGH PROFILE)

5-PRONG, MOBILE
 QN46GP5HMC (HEIGHT ADJUSTABLE)

4-LEG WOOD LEG
 QN46GP4W

PLASTIC COLORS



METAL BASE FINISHES



GRIN® GUEST



- One seat
- Armless
- Available with wood and metal legs
- Horizontal stitch options

GUEST
 QN49GUW (WOOD LEG)
 QN49GUNW (WOOD LEG, NO STITCH)
 QN49GUM (METAL LEG)
 QN49GUNM (METAL LEG, NO STITCH)

*Grin lounge and stools also available in Quick Delivery.



CONFIDE® GUEST+TANDEM

- Upholstered back with optional wood accent
- Easy clean out feature
- Waterfall seat edge
- Wood or black arm caps
- Steel frame available in cinder and platinum metallic
- Wall saver leg design

GUEST, ARMS
 QN78GFAW (WOOD BACK)
 QN78GFAU (UPHL. BACK)

GUEST, ARMLESS
 QN78GFMW (WOOD BACK)
 QN78GFMU (UPHL. BACK)



MIX-IT® GUEST

- Upholstered or black mesh back
- Wood or soft black arm pads
- Steel frame available in black or platinum metallic
- Wall saver leg design

UPHOLSTERED BACK GUEST
 QN12QQ (POLYURETHANE ARM PADS)

MESH BACK GUEST
 QN15RR (POLYURETHANE ARM PADS)

PLASTIC BACK GUEST
 QN12RR (POLYURETHANE ARM PADS)

*Mix-it task also available in Quick Delivery.

ELOQUENCE® GUEST

- Upholstered back
- Ganging chairs, tandem, and tables
- Wood frame

GUEST
QN85SA (HALF UPHL. BACK)
QN85SB (FULLY UPHL. BACK)

**ADMIRE® GUEST**

- Wood frame/arms

GUEST FULLY UPHOLSTERED BACK
QN55AA (ARMS)

**ELOQUENCE® TANDEM**

- Two and three seat tandem
- Ganging chairs and tables
- Upholstered back
- Wood frame

TANDEM
QN85SAA (TWO SEAT)
QN85SAAA (THREE SEAT)

GANGING CENTER TABLE
QN85SG (WOOD TOP)

GANGING CORNER TABLE
QN85SH (WOOD TOP)

GANGING BRACKET
QN85SJ (WOOD)

**ACQUAINT® GUEST**

- Half upholstered back and fully upholstered back
- Arm and armless
- Wood frame/arms
- Wall saver leg design

HALF UPHOLSTERED BACK
QN59AL (ARMLESS)
QN59AA (ARMS)

FULLY UPHOLSTERED BACK
QN59BL (ARMLESS)
QN59BB (ARMS)

**TIMBERLANE™ GUEST**

- Fully upholstered back
- Wood frame

GUEST
Q39U-GWXX



GUEST SEATING

DAVARI® GUEST

- Upholstered back
- Arm and armless
- Wood frame
- Wall saver leg design

DESCRIPTION
QN48GFM (ARMLESS)
QN48GFA (ARMS)



WELI™ GUEST

- Arm and armless
- Cinder or platinum metallic metal frame
- Cinder polyurethane arm cap
- Wall saver leg

21" GUEST CHAIR
QN81GAM (ARMLESS)
QN81GAAY (ARMS)

27" GUEST CHAIR
QN81GBM (ARMLESS)
QN81GBAY (ARMS)

32" GUEST CHAIR
QN81GCM (ARMLESS)
QN81GCAY (ARMS)



ALL PRICES ARE LIST PRICE

STOOLS

GRIN® STOOL

- One seat
- Armless
- Counter and bar height
- Wood legs available in all wood finishes
- Metal legs available in black and polished
- Horizontal stitch options

COUNTER HEIGHT
QN49CUW (WOOD LEG)
QN49CUNW (WOOD LEG, NO STITCH)
QN49CUM (METAL LEG)
QN49CUNM (METAL LEG, NO STITCH)

BAR HEIGHT
QN49BUW (WOOD LEG)
QN49BUNW (WOOD LEG, NO STITCH)
QN49BUM (METAL LEG)
QN49BUNM (METAL LEG, NO STITCH)

*Grin lounge and guest also available in Quick Delivery.



JEWEL™ STOOL

- Wood shell with cutout handle
- Bar height
- Armless
- Ganging options
- Polished tubular steel frame
- Wall saver leg design

ARMLESS STOOL
N44SM2WIM (BRIGHTON) (PKG. 2)
N44SM2WPE (PECAN) (PKG. 2)
N44SM2WWH (WHITE) (PKG. 2)
N44SM2WGR (GREY) (PKG. 2)
N44SM2WBL (BLACK) (PKG. 2)

GANGING BRACKET
QN44GB (PKG. 5 PAIRS)

*Jewel guest chair also available in Quick Delivery.



WOOD FINISHES

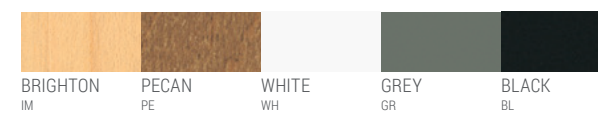

DITTO™ STOOL

- Plastic shell with vented back
- Counter and bar height
- Armless
- Polished steel sled base
- Clear nylon glides; felt glide option

COUNTER HEIGHT
 QN36CM
 QN36C2M (PKG. 2)

BAR HEIGHT
 QN36SM
 QN36S2M (PKG. 2)

*Ditto guest chairs also available in Quick Delivery.

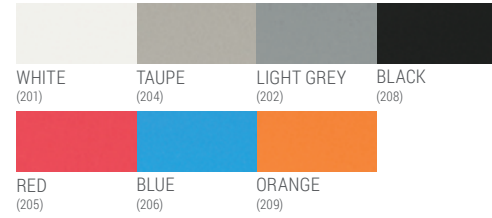

CINCH® TASK STOOL

- Plastic seat and back; upholstered seat option
- Arm and armless
- Swivel control; pneumatic lift
- Adjustable foot ring
- Optional contrasting plastic
- 5-prong platinum metallic or black nylon base
- Hard or soft casters

PLASTIC SEAT
 QN45JPL (ARMLESS)
 QN45JP (ARMS)

UPHOLSTERED SEAT
 QN45JUL (ARMLESS)
 QN45JU (ARMS)

*Cinch stacker, task, and beam seating also available in Quick Delivery.

PLASTIC COLORS

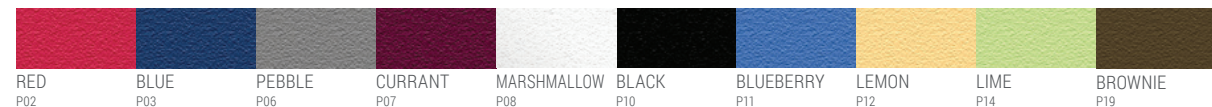

ALL PRICES ARE LIST PRICE

CINCH® COUNTER AND BAR STOOL

- Plastic seat and back; upholstered seat option
- Counter and bar height
- Armless
- Optional contrasting plastic
- Cinder or platinum metallic steel frame
- Hard or soft glides

COUNTER HEIGHT
 QN45CCP (PLASTIC SEAT)
 QN45CC2P (PLASTIC SEAT) (PKG. 2)
 UPHOLSTERED SEAT QN45CCU
 UPHOLSTERED SEAT QN45CC2U (PKG. 2)

BAR HEIGHT
 QN45CBP (PLASTIC SEAT)
 QN45CB2P (PLASTIC SEAT) (PKG. 2)
 QN45CBU (UPHL. SEAT)
 QN45CB2U (UPHL. SEAT) (PKG. 2)



SHOWN WITH STRASSA® COLLABORATIVE TABLES, ALSO AVAILABLE IN QUICK DELIVERY. FOOTRAILS NOT IN QUICK DELIVERY PROGRAM

WEITZ™ STOOL

- Upholstered seat cushion
- Height adjustable
- Leather handle
- Black base

STOOL
 QN96S1

RIZORA® STOOL

- Worksurface, counter, and bar height
- Polypropylene seat; upholstered seat pad option
- Polished chrome foot rest
- Wood legs available in 19 wood finishes

WORKSURFACE HEIGHT STOOL
 QN40G1
 QN40G2 (PKG. 2)

WORKSURFACE HEIGHT STOOL, UPHOLSTERED SEAT
 QN40GU1
 QN40GU2 (PKG. 2)

COUNTER HEIGHT STOOL
 QN40C1
 QN40C2 (PKG. 2)

COUNTER HEIGHT STOOL, UPHOLSTERED SEAT
 QN40CU1
 QN40CU2 (PKG. 2)

BAR HEIGHT STOOL
 QN40B1
 QN40B2 (PKG. 2)

BAR HEIGHT STOOL, UPHOLSTERED SEAT
 QN40BU1
 QN40BU2 (PKG. 2)

PLASTIC COLORS



RALLA™ TASK STOOL

- Upholstered cushion seat
- Height adjustable lever
- 5-prong black plastic base
- Black footring
- Standard dual black hard wheel casters

TASK STOOL
QN61PES

TASK STOOL WITH FOOTRING
QN61PESR



BEAM SEATING



CINCH® BEAM

- 2-seat, 3-seat, 4-seat, and 5-seat
- Plastic seat and back
- Arm, tablet arm, or armless
- Steel beam/legs available in platinum metallic or cinder
- Optional contrasting plastic
- Optional upholstered seat
- Optional laminate table

BEAM CHAIR KITS
QN45P1 (1-CHAIR, PLASTIC)
QN45U1 (1-CHAIR, UPHL. SEAT)
QN45P2 (2-CHAIR, PLASTIC)
QN45U2 (2-CHAIR, UPHL. SEAT)
QN45P3 (3-CHAIR, PLASTIC)
QN45U3 (3-CHAIR, UPHL. SEAT)

BLACK BEAMS
N45K2B (2-SEAT)
N45K3B (3-SEAT)
N45K4B (4-SEAT)
N45K5B (5-SEAT)

BLACK BEAM ARM KIT
N45MBB (PKG. 1)
N45MCB (PKG. 2)

BLACK BEAM TABLET KIT
N45TB

BLACK BEAM TABLE KIT
N45TAB

PLATINUM METALLIC BEAMS
N45K2P (2-SEAT)
N45K3P (3-SEAT)
N45K4P (4-SEAT)
N45K5P (5-SEAT)

PLATINUM METALLIC BEAM ARM KIT
N45MBP (PKG. 1)
N45MCP (PKG. 2)

PLATINUM METALLIC BEAM TABLET KIT
N45TP

PLATINUM METALLIC BEAM TABLE KIT
N45TAP

*Cinch counter, bar, and task stools, and stacker and task seating also available in Quick Delivery.

PLASTIC COLORS

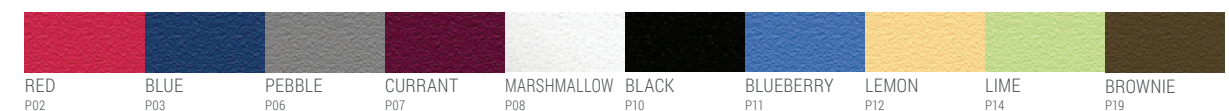



MODEL SHOWN: QN27MM2PS

LAUDIO® MESH BACK

SELECT MODEL SHIPS IN 2 DAYS

- Armless, height adjustable, or static arms
- Synchronous control features adjustable tension and back lock
- Pneumatic lift
- Optional seat slide
- Black or grey frame and base
- Black, light grey, medium grey, red, green, and blue mesh back

ALL MODELS AVAILABLE

FUEL® SPECIALTY TASK



- Mid back
- Synchronous tilt control; pneumatic lift
- Adjustable back height
- Static loop arm and armless
- 5-prong black aluminum base
- Hard or soft casters

LARGE AND TALL

- Oversized seat/back
- Upholstered seat and extreme back
- Supports up to 425 lbs.

QN35MAC (ARMLESS)
QN35MBC (STATIC LOOP ARMS)

INTENSIVE USE

- Designed for heavy-duty, 24/7 use
- Black plastic extreme back

QN35JAC (ARMLESS)
QN35JCC (STATIC LOOP ARMS)

LAVORO® TASK

UPHOLSTERED BACK

- High back and mid back
- Arm and armless
- Synchronous tilt control; pneumatic lift
- Armless, static arm, height adjustable with armrest depth, height and width adjustable with armrest depth, or conference arm
- Adjustable back height
- Optional black plastic extreme back
- Optional seat slide
- 5-prong polished aluminum or black nylon base

ALL MODELS AVAILABLE

*Lavoro guest also available in Quick Delivery.

MESH BACK

- High back
- Black mesh back
- Synchronous tilt control; pneumatic lift
- Optional adjustable lumbar
- Armless, static arm, height adjustable with armrest depth, height and width adjustable with armrest depth, or conference arm
- Optional seat slide
- 5-prong polished aluminum or black nylon base
- Hard or soft casters

ALL MODELS AVAILABLE



MODELS SHOWN: QN30MU2SSP, QN30HML2SSP

ALL PRICES ARE LIST PRICE

MIX-IT® TASK

- High back and mid back upholstered models with black plastic extreme back or black mesh back models
- Synchronous tilt control; pneumatic lift
- Adjustable back height
- Optional seat slide
- 5-prong black nylon base
- Hard or soft casters
- See price list for additional models

UPHOLSTERED MID BACK SYNCHRONOUS

QN12TJC (HEIGHT ADJ. ARMS)
QN12JJC (HEIGHT/WIDTH ADJ. ARMS)
QN12JJCE (HIGH PERFORMANCE ARM)

*Mix-it guest also available in Quick Delivery.

UPHOLSTERED MID BACK SYNCHRONOUS, SEAT SLIDE

QN12TJCS (HEIGHT ADJ. ARMS)
QN12JJCS (HEIGHT/WIDTH ADJ. ARMS)
QN12JJCES (HIGH PERFORMANCE ARM)

UPHOLSTERED HIGH BACK SYNCHRONOUS, SEAT SLIDE

QN12TMCS (HEIGHT ADJ. ARMS)
QN12MMCS (HEIGHT/WIDTH ADJ. ARMS)
QN12MMCES (HIGH PERFORMANCE ARM)

MESH BACK SYNCHRONOUS, SEAT SLIDE

QN15TMS (HEIGHT ADJ. ARMS)
QN15MMS (HEIGHT/WIDTH ADJ. ARMS)
QN15MMES (HIGH PERFORMANCE ARM)





VORA™ TASK

SELECT MODEL SHIPS IN 2 DAYS

- Mid back
- Black mesh back
- Swivel and knee tilt control options; pneumatic lift
- Height adjustable arms
- Hard or soft casters

TASK CHAIR, BLACK SEAT, SHIPS IN 2 DAYS

N54BMM3ST (SWIVEL TILT)
N54BMM3KT (KNEE TILT)

TASK CHAIR, BLACK MESH BACK

QN54AMM3ST (SWIVEL TILT)
QN54AMM3KT (KNEE TILT)



CINCH® TASK

- Arm or armless
- Plastic back and seat; upholstered seat option
- Swivel control; pneumatic lift
- Optional contrasting plastic
- 5-prong platinum metallic or black nylon base
- Hard or soft casters

PLASTIC SEAT
QN45HPL (ARMLESS)
QN45HP (ARMS)

UPHOLSTERED SEAT
QN45HUL (ARMLESS)
QN45HU (ARMS)

*Cinch counter, bar, and task stools, and stacker and beam seating also available in Quick Delivery.



WHIRL™ TASK

SELECT MODEL SHIPS IN 2 DAYS

- Mid back
- Black mesh back
- Height adjustable arms
- Height adjustable lumbar
- Headrest available
- Black nylon base

TASK CHAIR, BLACK MESH AND SEAT, HEIGHT AJUSTABLE ARMS, SHIPS IN 2 DAYS

N28BML33LSS (SYNCHRO 3-LOCK, SEAT SLIDE)

TASK CHAIR, BLACK MESH BACK, ADJUSTABLE ARM

QN28AMML33LSS (SYNCHRO 3-LOCK, SEAT SLIDE)
QN28AMML34LSS (SYNCHRO 4-LOCK, SEAT SLIDE)

HEADREST

N28HRB



ESSAY® STUDENT CHAIR

- Rectangle or chevron shape tablet arm
- Plastic shell with vented back; upholstered seat option
- 6 plastic colors
- 360° fixed height swivel
- Under seat tray
- Optional black thermofoil tablet arm; optional cup holder
- Grey or black nylon base; static or mobile options
- Hard or soft casters; hard or soft glides

STUDENT CHAIR, MOBILE

QN21AAC
QN21AAUC (UPL. SEAT)

STUDENT CHAIR, STATIC

QN21AAG
QN21AAG (UPL. SEAT)

STUDENT CHAIR WITH TABLET, MOBILE

QN21AATC
QN21AATUC (UPL. SEAT)

STUDENT CHAIR WITH TABLET, STATIC

QN21AATG
QN21AATUG (UPL. SEAT)

CUP HOLDER

QN21CUP

*Essay task chair also available in Quick Delivery.





ESSAY® TASK

TASK CHAIR

- Plastic shell with vented back
- Swivel control; pneumatic lift
- Optional upholstered seat cushion
- Optional black thermofoil tablet arm with or without cup holder
- 5-prong black nylon base
- Static or mobile options
- Hard or soft casters
- Hard or soft glides

TASK STOOL

- Plastic shell with vented back
- Swivel control; pneumatic lift
- Adjustable foot ring
- Optional upholstered seat cushion
- 5-prong black nylon base
- Static or mobile options
- Hard or soft casters
- Hard or soft glides

TASK CHAIR, MOBILE

- QN21BBC
- QN21BBUC (UPHL. SEAT)

TASK CHAIR, STATIC

- QN21BBG
- QN21BBUG (UPHL. SEAT)

TASK CHAIR WITH TABLET, MOBILE

- QN21BBTC
- QN21BBTUC (UPHL. SEAT)

TASK CHAIR WITH TABLET, STATIC

- QN21BBTG
- QN21BBTUG (UPHL. SEAT)

TASK STOOL, MOBILE

- QN21CCC
- QN21CCUC (UPHL. SEAT)

TASK STOOL, STATIC

- QN21CCG
- QN21CCUG (UPHL. SEAT)

UPHOLSTERED SEAT CUSHION

- QN21UPH

CUP HOLDER

- QN21CUP

*Essay student chair also available in Quick Delivery.

PLASTIC COLORS

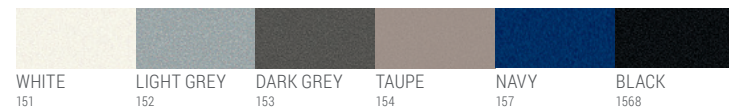

ALL PRICES ARE LIST PRICE



TRIUMPH™

- High back and low back models
- Knee tilt control mechanism
- Wood arm with soft black polyurethane arm caps
- Wood base

HIGH BACK
Q89X-EWECC

LOW BACK
Q89X-MWECC

GUEST
Q89X-GWXX

RESPECT®

- High back and mid back
- Knee tilt control; pneumatic lift
- Black arms with soft black arm pads
- Black nylon base
- Hard or soft casters

HIGH BACK
QN75BAC

MID BACK
QN75BCC

GUEST
QN75WS



ALL PRICES ARE LIST PRICE



QWW2315PUBBFW, QWW2315PUFFW, QWW2472WSSDW, QWW3072WSSDW, QWW7227MPW, QWW7238HBH2W (\$9,819)
SHOWN WITH MIX-IT® TASK AND MIX-IT® GUEST, ALSO AVAILABLE IN QUICK DELIVERY.



QWW2315PUBBFL, QWW2315PUBBFL-QWW2328EPL, QWW2448WSSDLL, QWW3072WSSDLL, QWW3618SOEML, QWW3618SOHML, QWW4827MPVL, QWW7227MPL (\$4,216)
SHOWN WITH LAUDIO® TASK AND LAVORO® GUEST, ALSO AVAILABLE IN QUICK DELIVERY.

WAVEWORKS® VENEER CASEGOODS

THOUGHT STARTERS

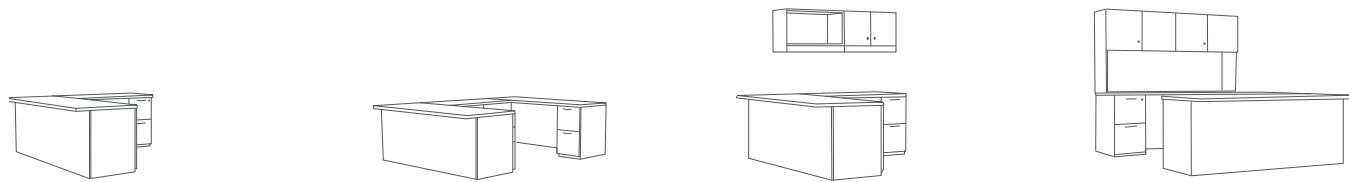

L-CONFIGURATION
78"D X 72"W

QWW2315PUBBFW
QWW2315PUFFW
QWW2328EPW
QWW2448WSSVDW
QWW3072WSSDW
QWW4827MPW
QWW7227MPW

U-CONFIGURATION
102"D X 72"W

QWW2315PUBBFW
QWW2315PUFFW
QWW2328EPW (X2)
QWW2448WSSVDW
QWW2472WSSDW
QWW3072WSSDW
QWW4827MPW
QWW7227MPW (X2)

L-CONFIGURATION WITH STORAGE
78"D X 72"W

QWW2315PUBBFW
QWW2315PUFFW
QWW2328EPW
QWW2448WSSVDW
QWW3018SOEML
QWW3018SOHML
QWW3072WSSDW
QWW4827MPW
QWW7227MPW

U-CONFIGURATION WITH STORAGE
102"D X 72"W

QWW2315PUBBFW
QWW2315PUFFW
QWW2328EPW (X2)
QWW2448WSSVDW
QWW2472WSSDW
QWW3072WSSDW
QWW4827MPW
QWW7227MPW (X2)
QWW7238HBH2W

WOOD FINISHES

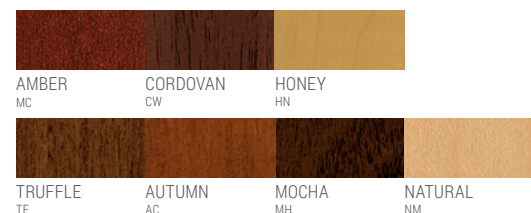

ALL PRICES ARE LIST PRICE

FEATURES



BEAM PULLS

NANTUCKET PULLS

SOFTENED RIM PROFILE
1 3/4" TFL WORKSURFACE

WAVEWORKS® LAMINATE CASEGOODS

THOUGHT STARTERS

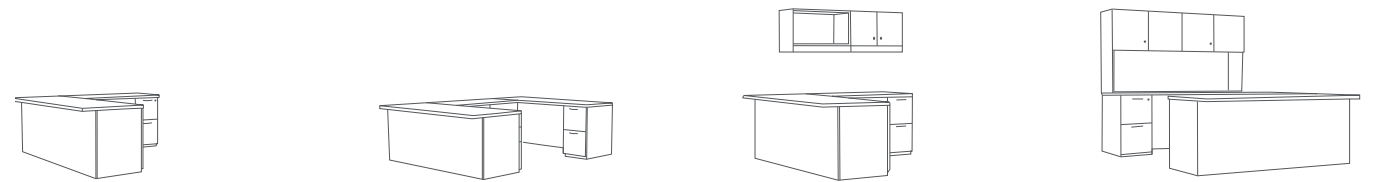

L-CONFIGURATION
78"D X 72"W

QWW2315PUBBFL
QWW2315PUFFL
QWW2328EPL
QWW2448WSSVDLL
QWW3072WSSDLL
QWW4827MPVL
QWW7227MPL

U-CONFIGURATION
102"D X 72"W

QWW2315PUBBFL
QWW2315PUFFL
QWW2328EPL (X2)
QWW2448WSSVDLL
QWW2472WSSDLL
QWW3072WSSDLL
QWW4827MPVL
QWW7227MPL (X2)

L-CONFIGURATION WITH STORAGE
78"D X 72"W

QWW2315PUBBFL
QWW2315PUFFL
QWW2328EPL
QWW2448WSSVDLL
QWW3018SOEML
QWW3018SOHML
QWW3072WSSDLL
QWW4827MPVL
QWW7227MPL

U-CONFIGURATION WITH STORAGE
102"D X 72"W

QWW2315PUBBFL
QWW2315PUFFL
QWW2328EPL (X2)
QWW2448WSSVDLL
QWW2472WSSDLL
QWW3072WSSDLL
QWW4827MPVL
QWW7227MPL (X2)
QWW7238HBH2L

TFL LAMINATES

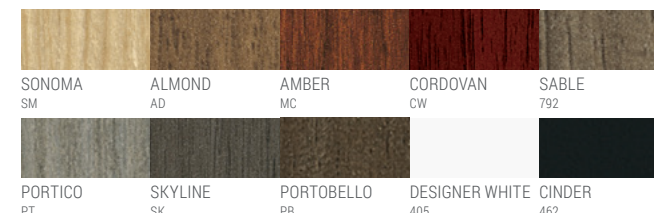

PORTICO
PT

SKYLINE
SK

PORTOBELLO
PB

DESIGNER WHITE
405

CINDER
462

FEATURES



BEAM PULLS

NANTUCKET PULLS

PVC SOFTENED RIM PROFILE
1 3/4" TFL WORKSURFACE



Q31N2172CKFW2, Q31N3672DDEFW8, Q31N7236HBHW (\$8,012)
SHOWN WITH MIX-IT™ TASK AND MIX-IT™ GUEST, ALSO AVAILABLE IN QUICK DELIVERY.

ARROWOOD™ VENEER CASEGOODS

THOUGHT STARTERS

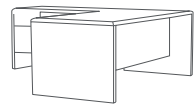

L-CONFIGURATION
88"D X 72"W

Q31N8872LLFW

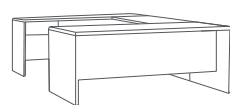

U-CONFIGURATION
108"D X 72"W

Q31N10872ULFW

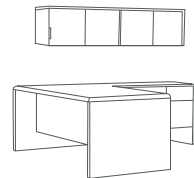

L-CONFIGURATION WITH STORAGE
88"D X 72"W

Q31N8872LRFW
Q31N3618SOHMMW (X2)

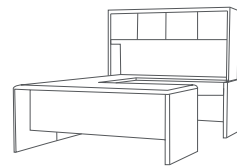

U-CONFIGURATION WITH STORAGE
108"D X 72"W

Q31N10872URFW
Q31N7236HBHW

WOOD FINISHES



AMBER MC CORDOVAN CW HONEY HN

FEATURES



SELF PULL MITERED RIM PROFILE
1 1/4" WORKSURFACE

ALL PRICES ARE LIST PRICE



Q21N8572LRQL, Q21N3365BCOFL (\$2,884)
SHOWN WITH ELOQUENCE™ GUEST AND LAUDIO™ TASK, ALSO AVAILABLE IN QUICK DELIVERY.

ARROWOOD™ LAMINATE CASEGOODS

THOUGHT STARTERS

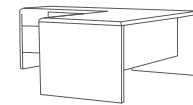

L-CONFIGURATION
85"D X 72"W

Q21N8572LLQL

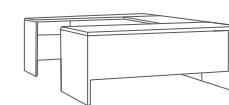

U-CONFIGURATION
108"D X 72"W

Q21N10872ULQL

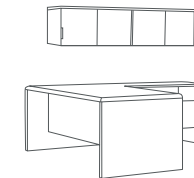

L-CONFIGURATION WITH STORAGE
85"D X 72"W

Q21N8572LRQL
Q21N3617SOHML (X2)

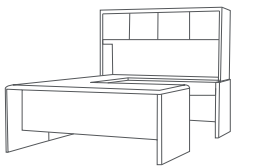

U-CONFIGURATION WITH STORAGE
108"D X 72"W

Q21N10872URQL
Q21N6936HBHL

TFL LAMINATES

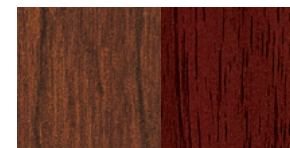

AMBER MC CORDOVAN CW

FEATURES



SELF PULL MITERED RIM PROFILE
1 1/4" TFL WORKSURFACE



Q50N2172CKFW2, Q50N3672DDFW8, Q50N7236HBHW (\$9,502)
SHOWN WITH LAVORO® TASK AND LAVORO® GUEST, ALSO AVAILABLE IN QUICK DELIVERY.

BARRINGTON® CASEGOODS

THOUGHT STARTERS

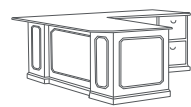
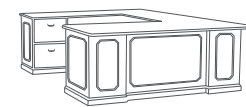
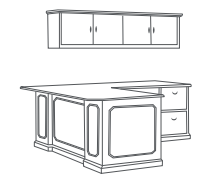
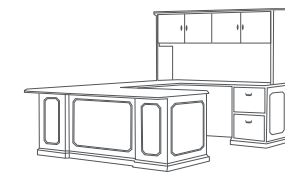
			
L-CONFIGURATION 86"D X 72"W Q50N8672LRFW	U-CONFIGURATION 107"D X 72"W Q50N10772ULFW	L-CONFIGURATION WITH STORAGE 86"D X 72"W Q50N8672LRFW Q50N7218SOHMMW (X2)	U-CONFIGURATION WITH STORAGE 107"D X 72"W Q50N10772URFW Q50N7236HBHW

WOOD FINISHES

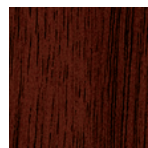

CORDOVAN
CW

FEATURES

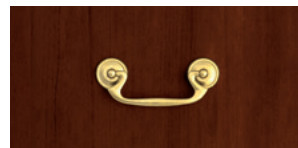

CLASSIC PULL
BRASS

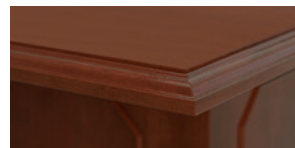

TRADITIONAL RIM PROFILE
1/4" WORKSURFACE



ALL PRICES ARE LIST PRICE



QECN10773URFW, QECN7250HBHPW, QNAC6920TBRA (\$11,746)
SHOWN WITH RESPECT® EXECUTIVE SEATING, ALSO AVAILABLE IN QUICK DELIVERY.

ESCALADE® CASEGOODS

THOUGHT STARTERS

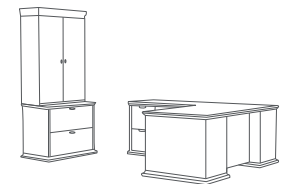
			
L-CONFIGURATION 85"D X 73"W QECN8573LLFW	U-CONFIGURATION 107"D X 73"W QECN10773URFW	TRADITIONAL CONFIGURATION WITH STORAGE 36"D X 73"W 22"D X 73"W QECN3673DDFBW8 QECN2273CSFW2 QECN7250HBHPW	L-CONFIGURATION WITH STORAGE 85"D X 73"W 22"D X 38"W QECN8573LLFW QECN2238LFF2W QECN3750BCHW

WOOD FINISHES

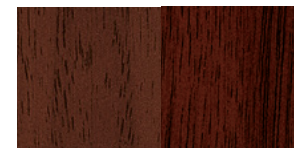

AMBER
MC CORDOVAN
CW

FEATURES



FLUID PULL
SATIN NICKEL





TRIBECA RIM PROFILE
1/4" WORKSURFACE



19N2451RREFW2, 19N3618SOHMM, 19N3666BCOFW, 19N3672DLFW1 (\$7,380)
SHOWN WITH LAVORO® TASK, ALSO AVAILABLE IN QUICK DELIVERY.

FLOURISH® CASEGOODS

THOUGHT STARTERS

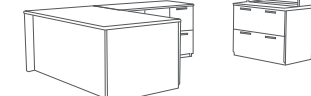
			
L-CONFIGURATION 87"D X 72"W Q19N8772LLFW	U-CONFIGURATION 111"D X 72"W Q19N11172URFW	U-CONFIGURATION WITH STORAGE 111"D X 72"W Q19N11172ULFW Q19N7236HBHW	L-CONFIGURATION WITH STORAGE 87"D X 72"W 24"D X 36"W Q19N8772LRFW Q19N2436LFF2W Q19N3636BCOW

WOOD FINISHES



AMBER MC CORDOVAN CW

FEATURES



CURVED PULL BLACK

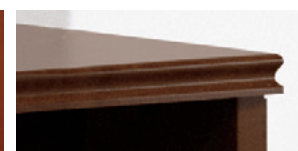

FLUTED RIM PROFILE 1/4" WORKSURFACE





ALL PRICES ARE LIST PRICE



Q75N3672DDY3L, Q75N2472CKY3L, Q75N7238HBH (\$4,229)
SHOWN WITH MIX-IT® TASK AND MIX-IT® GUEST, ALSO AVAILABLE IN QUICK DELIVERY.

RENEGADE™ CASEGOODS

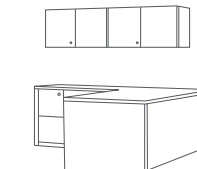
THOUGHT STARTERS

			
L-CONFIGURATION 85"D X 72"W Q75N8572LLYL	U-CONFIGURATION 109"D X 72"W Q75N10972ULYL	L-CONFIGURATION WITH STORAGE 85"D X 72"W Q75N8572LLFL Q75N3618SOHM (X2)	L-CONFIGURATION WITH STORAGE 121"D X 72"W Q75N3668BCOF Q75N8572LRYL

TFL LAMINATES

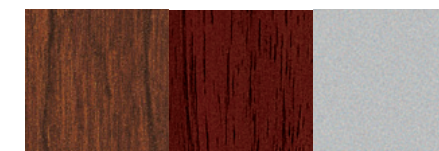

AMBER MC CORDOVAN CW PLATINUM GREY 478

FEATURES



INTEGRATED PULL



SOFTENED PVC RIM PROFILE 1/4" TFL WORKSURFACE



Q51N8672LLFLW, Q51N3618SOHMM, Q51N2137LFF2LW, Q51N3436BCDFW, Q51N1436CPCFW (\$8,683)
SHOWN WITH TRIUMPH® EXECUTIVE TASK AND TRIUMPH® GUEST, ALSO AVAILABLE IN QUICK DELIVERY.

ROOSEVELT™ CASEGOODS

THOUGHT STARTERS

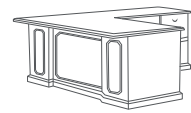

L-CONFIGURATION
86"D X 72"W

Q51N8672LRFLW

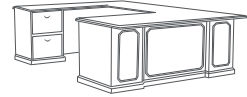

U-CONFIGURATION
107"D X 72"W

Q51N10772ULFLW

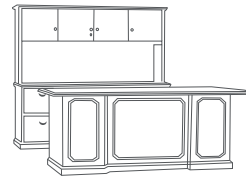

TRADITIONAL CONFIGURATION WITH STORAGE
21"D X 72"W
36"D X 72"W

Q51N2172CKFLW2
Q51N3672DDFLW8
Q51N7236HBHW



L-CONFIGURATION WITH STORAGE
86"D X 72"W
21"D X 36"W

Q51N1435CPBW
Q51N1436CPCFW
Q51N2137LFF2LW
Q51N3436BCDFW
Q51N8672LRFLW

WOOD FINISHES

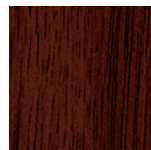

CORDOVAN
CW

ALL PRICES ARE LIST PRICE

FEATURES

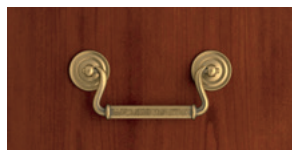

SCROLL PULL
ANTIQU BRASS



TRADITIONAL RIM PROFILE
1/4" WORKSURFACE



CBV3028US, QWW233022PUBLL, QWW3072WSSDLL, NAC3006SESS, QWW233022PUOSL, QWW24A60WSSDLL (\$6,514)
SHOWN WITH VORA™ TASK, ALSO AVAILABLE IN QUICK DELIVERY.

WAVEWORKS® VENEER+LAMINATE CASEGOODS

THOUGHT STARTERS

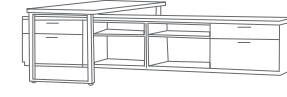

OPEN CONFIGURATION
72"D X 120"W

CBV3028US
NAC3006SESS
QWW233022PUBLL (X2)
QWW233022PUOSL (X2)
QWW24A60WSSDLL (X2)
QWW3072WSSDLL
QWW60A21MPL (X2)
NAC0248SUR

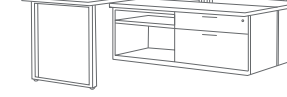

OPEN CONFIGURATION
144"D X 60"W

CBV3028US (X2)
NAC3006SESS (X2)
QWW233022PUBLL (X2)
QWW233022PUOSL (X2)
QWW24A60WSSDLL (X2)
QWW3072WSSDLL (X2)
QWW60A21MPL (X2)
NAC0248SUR (X2)

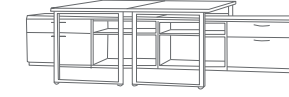

OPEN CONFIGURATION
72"D X 120"W

CBV3028US (X2)
NAC3006SESS (X2)
QWW233022PUBLL (X2)
QWW233022PUOSL (X2)
QWW24A60WSSDLL (X2)
QWW3072WSSDLL (X2)
QWW60A21MPL (X2)
NAC0248SUR (X2)

FEATURES



BEAM PULLS



NANTUCKET PULLS



PVC SOFTENED RIM PROFILE
1 1/4" TFL WORKSURFACE

WOOD FINISHES

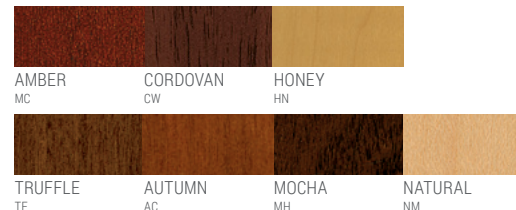

TFL LAMINATES

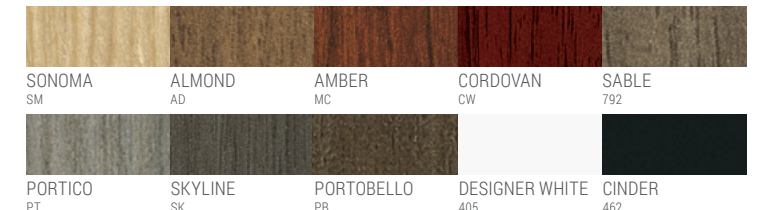

OPEN PLAN WORKSTATIONS



Q71N6072AB2PGLL (X3) (\$13,905)
SHOWN WITH LAVORO® TASK, ALSO AVAILABLE IN QUICK DELIVERY.

ALLOY™ BENCHING

THOUGHT STARTERS



2-USER STATION
60"D X 72"W

71N40VWM22 (X2)
Q71N6072AB2PGLL
Q71N7023PVCPPFA (X2)

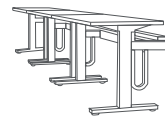

3-USER STATION
24"D X 180"W

Q71N2460AB1PGLL (X3)
71N40VWM22 (X3)
71NGBSA22 (X2)

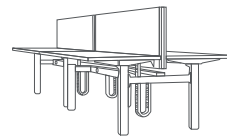

4-USER STATION
60"D X 144"W

71N40VWM22 (X4)
Q71N6072AB2PGLL (X2)
Q71N7023PVCPPFA (X4)
71NGBK22

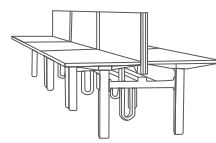

6-USER STATION
60"D X 216"W

71N40VWM22 (X6)
Q71N6072AB2PGLL (X3)
Q71N7023PVCPPFA (X6)
71NGBK22 (X2)

TFL LAMINATES

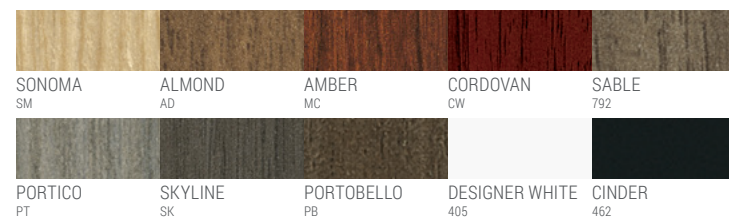

ALL PRICES ARE LIST PRICE

BASE COLOR



SILVER

FEATURES



PVC SOFTENED RIM PROFILE
1 1/4" TFL WORKSURFACE

RECEPTION WORKSTATIONS



QWW2572DSTF3LL, QWW2460RSTFALL, QWW1572TSLL, QWW2315PUBBFL, QWW2315PUFFL (\$4,795)
SHOWN WITH LAUDIO® TASK, ALSO AVAILABLE IN QUICK DELIVERY.

WAVEWORKS® RECEPTION STATIONS

THOUGHT STARTERS

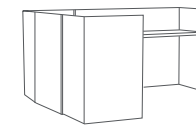

L-CONFIGURATION
75"D X 72"W

QWW2460RSTFRLL
QWW2572DSTF3LL

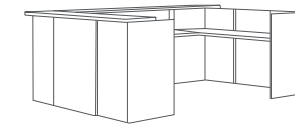

U-CONFIGURATION
72"D X 113"W

QWW1578TSLL
QWW1597TSLL
QWW2563BSTFLL
QWW2572DSTF3LL (X2)

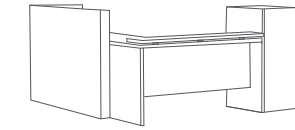

ADA L-CONFIGURATION
75"D X 72"W

QWW1154TSLL
QWW2460RSTFRLL
QWW2472DSTFLL

FEATURES

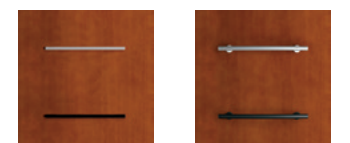

BEAM PULLS

NANTUCKET PULLS



PVC SOFTENED RIM PROFILE
1 1/4" TFL WORKSURFACE

WOOD FINISHES

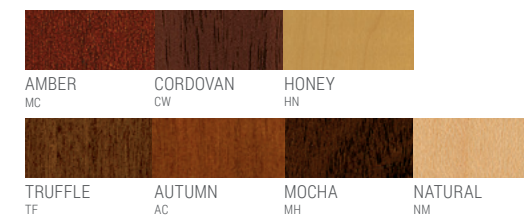

ALL PRICES ARE LIST PRICE

TFL LAMINATES

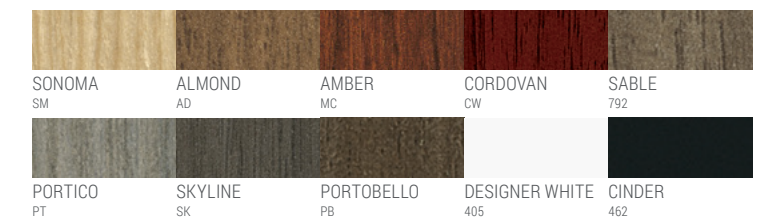



CLAMP MOUNT

- Above worksurface height is 24"
- Extends 3" below the worksurface
- Clamp is plastic with a non-marring foam
- Low level of complexity—can be installed by 1 person
- QD order must be 20 screens or less

27" HEIGHT
23"–71" W

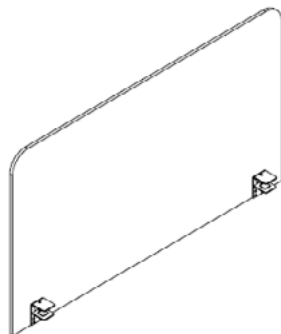

CLAMP PAINT COLOR



PLATINUM METALLIC MC

SCREEN MATERIAL



DESIGNER WHITE LAMINATE 405

POLYCARBONATE SET-ON SCREEN

- Semi-opaque fluted polycarbonate screen
- Metal mounting bracket
- Clear rubber bumpers on bottom of brackets
- Clear U-channel edge molding attached on all sides of screen
- Low level of complexity—can be installed by 1 person
- QD order must be 20 screens or less

24" HEIGHT
21"–72" W

30" HEIGHT
21"–72" W

CLAMP PAINT COLOR

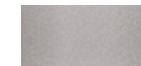

PLATINUM METALLIC MC

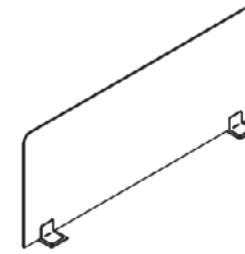

SCREEN MATERIAL



FLUTED, SEMI-OPAQUE POLYCARBONATE

POLYCARBONATE EDGE MOUNT SCREEN

- Screen extends 4" below worksurface
- Semi-opaque reeded polycarbonate screen
- Metal mounting bracket
- Clear U-Channel edge molding attached on all sides of screen
- Will require attachment to surface with fasteners—2 people recommended for installation
- QD order must be 20 screens or less

18" ABOVE WORKSURFACE HEIGHT
21"–72" W

24" ABOVE WORKSURFACE HEIGHT
21"–72" W

34" ABOVE WORKSURFACE HEIGHT
21"–72" W

CLAMP PAINT COLOR

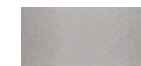

PLATINUM METALLIC MC

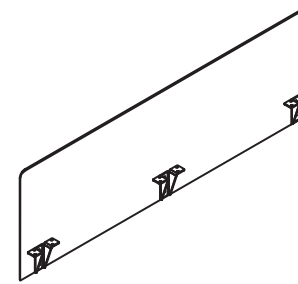

SCREEN MATERIAL



FLUTED, SEMI-OPAQUE POLYCARBONATE

POLYCARBONATE EDGE MOUNT SCREEN/MODESTY

- Screen extends 12" below worksurface
- Semi-opaque reeded polycarbonate screen
- Metal mounting bracket
- Clear U-Channel edge molding attached on all sides of screen
- Will require attachment to surface with fasteners—2 people recommended for installation
- QD order must be 20 screens or less

18" ABOVE WORKSURFACE HEIGHT
21"–72" W

24" ABOVE WORKSURFACE HEIGHT
21"–72" W

30" ABOVE WORKSURFACE HEIGHT
21"–72" W

CLAMP PAINT COLOR

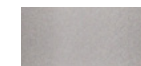

PLATINUM METALLIC MC

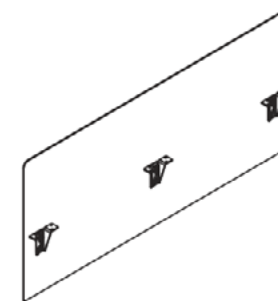

SCREEN MATERIAL



FLUTED, SEMI-OPAQUE POLYCARBONATE

ACCESSORIES

CENTER DRAWERS



WOOD CENTER DRAWER

- Wood
- Cordovan, Honey, or Amber finish
- Extends 10" from worksurface edge
- Features a pencil divider, drawer stops, and hardware
- QNAC2124CDW features an upgraded suspension

QNAC2124CDW
QNAC1824CDW



LAMINATE CENTER DRAWER

- TFL Laminate
- Cordovan or Amber laminate
- Features a flat front edge for a flush profile when drawer is closed
- Extends 18" from worksurface edge

QNAC2421CDL

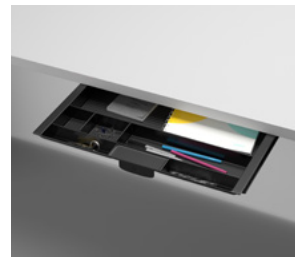

PLASTIC CENTER DRAWER

- Black plastic
- Features individual compartments ideal for small office supplies

NAC1922CD

CORNER SLEEVES

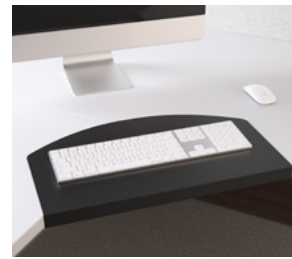

METAL CORNER SLEEVE

- Black metal
- Attaches across corner of 90° units
- Creates a 45° worksurface ideal for computer use

NAC1322SL2
NAC1222SL

DRAWER ORGANIZERS

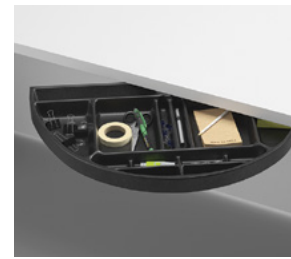

CAROUSEL TRAY

- Black plastic
- Molded plastic tray features individual compartments ideal for organizing small office supplies
- Rotates outward from either left or right side

NAC1624CT



DELUXE DRAWER ORGANIZER

- Black plastic
- Individual compartments for organizing small office supplies
- Convenient Post-it® note storage
- Expands to 16" wide

NAC1211D0



BOX DRAWER CONVENIENCE TRAY

- Black plastic
- Holds pencils, pens, paper clips, etc.
- For use in 15" wide pedestals

NAC0613ST

KEYBOARD KITS+TRAYS



KEYBOARD TRAY

- Black metal
- Keyboard height can range from 2 1/32" to 3 11/32" in 1/32" increments
- Tray is 24" wide

NAC1424KT



KEYBOARD TRAY+MOUSE PAD

- Black metal
- Includes height adjustable keyboard tray, adjustable palm rest, and sliding mouse tray
- Mouse tray extends on either left or right side of keyboard

NAC1924KTM

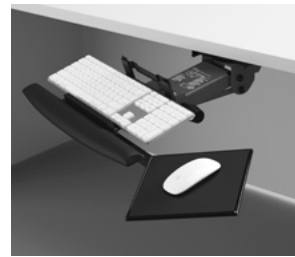

BASIC ADJUSTABLE KEYBOARD KIT

- Black metal
- Includes keyboard mechanism, clamp, wrist pad, and mouse tray
- Simultaneous tilt and height adjust with 360° swivel

NAC1706KK3

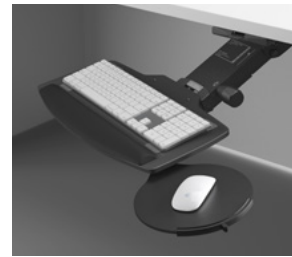

INTUITIVE ADJUSTABLE KEYBOARD KIT

- Black metal
- Includes keyboard mechanism, tray platform, foam gel wrist pad, and adjustable mouse tray
- Dial tilt allows for adjustment from -10° to 15° and slides in and out under worksurface;
- Arm tilts and moves up and down; 360° swivel

NAC1706KK1 (17" ARM)
NAC2208KK1 (21 3/4" ARM)

COMPUTER SUPPORT



CPU HOLDER

- Black metal
- Self-locking ratchet style CPU storage device with Teflon® glide storage
- Height and width adjustable; Rotates 360°
- Fits CPUs up to 9" wide, up to 85 lbs.
- Mounts to underside of worksurface

NACPUH

POWER+DATA



ROUND GROMMET (G10)

- Black nylon
- Removable cap sits on legs above flange with enough room for wires to pass
- Includes (2) power outlets and (2) Cat5e data ports
- UL® listed

ELECTRICAL
NACG10EL
NON-ELECTRICAL
NACG10

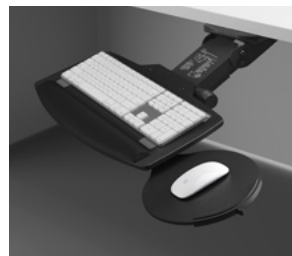

ERGONOMIC ADJUSTABLE KEYBOARD KIT

- Black metal
- Includes keyboard mechanism, tray platform, foam gel wrist pad, and adjustable mouse tray
- Tray adjusts from -10° to 15° and slides in and out under worksurface; Arm tilts and moves up and down; 360° swivel

NAC1706KK2

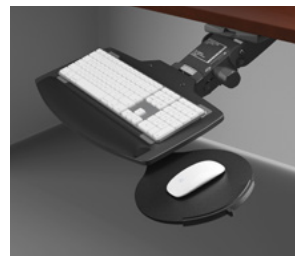

CLEVER® KEYBOARD KIT

- Black metal
- Includes keyboard mechanism, tray platform, foam gel wrist pad, and adjustable mouse tray
- Simultaneous tilt and height adjustment; slides in and out under worksurface; 360° swivel
- For use only with Clever® casegoods

NAC1406KK4

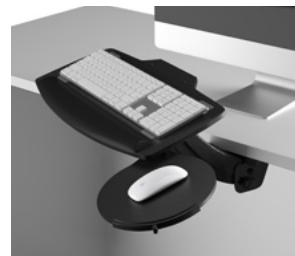

SIT-TO-STAND ADJUSTABLE KEYBOARD KIT

- Black metal
- Adjusts intuitively from sitting to standing height; 7" below worksurface and 41/4" above worksurface
- Tray adjusts from -10° to 15°

NAC2319KKS1

WIRE MANAGEMENT



GROMMET (G1)

- Black nylon, 2 1/4" diameter
- Two-piece grommet

NACG1



FLEXI GROMMET (G2)

- Black nylon, 2 1/4" diameter
- Standard on Clever® casegoods

NACG2



WIRE MANAGER

- Black plastic
- Manages and routes unruly data and power cords
- Attaches vertically or horizontally above or below worksurface

NAC17WM



HORIZONTAL UNDERSURFACE WIRE MANAGER

- Black plastic
- Can be used on any unit to manage and route data and power cords
- Attaches below worksurface

NAC30WMH



TACK BOARDS

- Mounts onto back panel of highback organizer or to wall

- 20H X 69W QNAC6920TBRA
- 19H X 70W QNAC7019TBRA
- 17H X 69W QNAC6917TBRA
- 17H X 67W QNAC6717TBRA
- 17H X 66W QNAC6617TBRA
- 16H X 68W QNAC6816TBRA

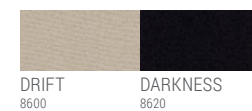

DRIFT 8600 DARKNESS 8620

WASTE CONTAINER



WASTE CONTAINER

- White plastic
- Concealed, pivoting waste container
- For use in buffet or double door storage credenzas

NAC1721WBSK

MARKER BOARD



MARKER BOARD

- Slim profile dry erase marker board with tray
- White board; black aluminum trim

NAC3048MBW



WAVEWORKS® METAL STORAGE

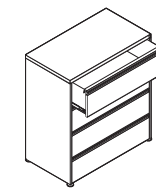

- Metal
- Cinder and platinum metallic
- Softened rim profile
- Integrated pulls
- Counterweight must be used unless ganging multiple lateral files

FOUR DRAWER LATERAL FILE
QWW1836LFF4M

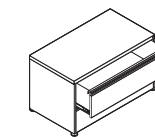

- Metal
- Cinder and platinum metallic
- Softened rim profile
- Integrated pulls
- Counterweight must be used unless ganging multiple lateral files

TWO DRAWER LATERAL FILE
QWW1836LFF2M

METAL PAINT COLORS

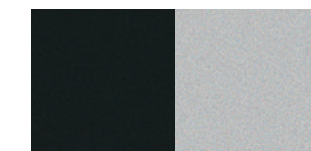

CINDER 462 PLATINUM METALLIC* 501

*10% UPCHARGE

FEATURES

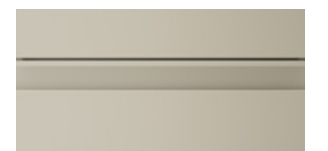

INTEGRATED PULL

FILING+STORAGE

LATERAL FILES

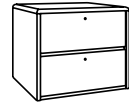

ARROWOOD™ VENEER

TWO DRAWER LATERAL FILE
Q31N2136LFF2W

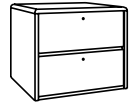

ARROWOOD™ LAMINATE

TWO DRAWER LATERAL FILE
Q21N2436LFF2L



BARRINGTON®

TWO DRAWER LATERAL FILE
Q50N2137LFF2W

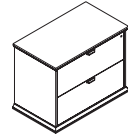

ESCALADE®

TWO DRAWER LATERAL FILE
QECN2238LFF2W

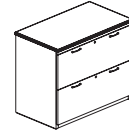

FLOURISH®

TWO DRAWER LATERAL FILE
Q19N2436LFF2W

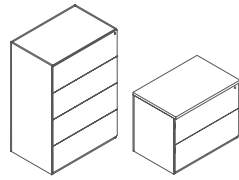

RENEGADE™

FOUR DRAWER LATERAL FILE
Q75N2436LFM4
TWO DRAWER LATERAL FILE
Q75N2436LFF2L



ROOSEVELT™

TWO DRAWER LATERAL FILE
Q51N2137LFF2LW

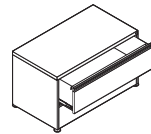

WAVEWORKS® METAL

FOUR DRAWER LATERAL FILE
QWW1836LFF4M
TWO DRAWER LATERAL FILE
QWW1836LFF2M
COUNTERWEIGHT
WW36CW2M

CREDENZAS

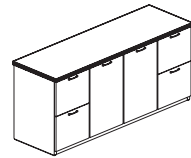

FLOURISH®

STORAGE CREDENZA
Q19N2472CSFW2

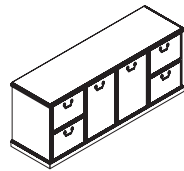

ROOSEVELT™

STORAGE CREDENZA
Q51N2172CSFLW2

BOOKCASES



ARROWOOD™ VENEER

BOOKCASE
Q31N3266BCOFW
SET-ON BOOKCASE
Q31N3238BCOW



ARROWOOD™ LAMINATE

BOOKCASE
Q21N3365BCOFL
SET-ON BOOKCASE
Q21N3336BCOL

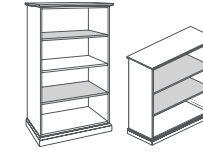

BARRINGTON®

BOOKCASE
Q50N3452BCOFW
Q50N1436CPCFW
Q50N1435CPBW

SET-ON BOOKCASE
Q50N3436BCOW
Q50N1436CPCFW
Q50N1435CPBW

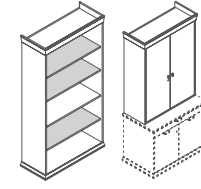

ESCALADE®

BOOKCASE
QECN3871BCOFW
SET-ON BOOKCASE, WOOD DOORS
QECN3750BCHW

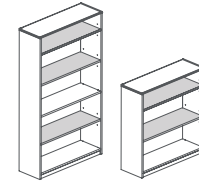

FLOURISH®

BOOKCASE
Q19N3666BCOFW
SET-ON BOOKCASE
Q19N3636BCOW

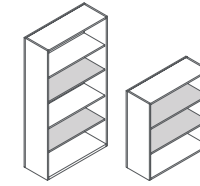

RENEGADE™

BOOKCASE
Q75N3668BCOF
SET-ON BOOKCASE
Q75N3638BCO

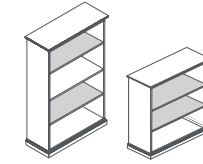

ROOSEVELT™

BOOKCASE
Q51N3452BCOFW
Q51N1436CPCFW
Q51N1435CPBW

SET-ON BOOKCASE
Q51N3436BCOFW
Q51N1436CPCFW
Q51N1435CPBW

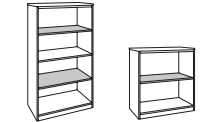

WAVEWORKS

BOOKCASE
QWW3679BCOFL
QWW3668BCOFL
QWW3653BCOFL
QWW3640BCOFL
QWW3628BCOFL
QWW3679BCOFW
QWW3668BCOFW
QWW3653BCOFW
QWW3640BCOFW
QWW3628BCOFW



SHOWN WITH RIZORA® STOOLS, ALSO AVAILABLE IN QUICK DELIVERY.



SHOWN WITH JEWEL® STOOLS, JEWEL® GUEST, AND WHIMSY® IMPROMPTU SEATING. ALSO AVAILABLE IN QUICK DELIVERY.

STRASSA® COLLABORATIVE TABLES

THOUGHT STARTERS

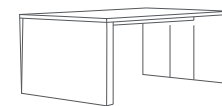

36"D X 28⁷/₈"H

Q86N367229WKN1LL

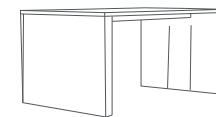

36"D X 35⁵/₈"H

Q86N367235WKN1LL

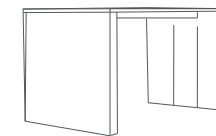

36"D X 41¹/₂"H

Q86N367241WKN1LL

TFL LAMINATES

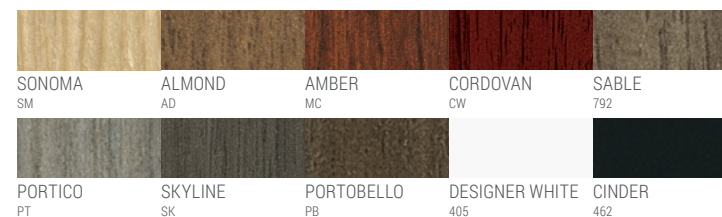

ALL PRICES ARE LIST PRICE

CONTRASTING OPTIONS



CONFERENCE+OFFICE TABLES



SHOWN WITH LAVORO® TASK, ALSO AVAILABLE IN QUICK DELIVERY.

UNIVERSAL TABLES

- TFL laminate top, base
- Amber and cordovan finish
- Flat rim profile

42" ROUND TABLE
QBP-18
QCP-42E

48" X 96" RACETRACK TABLE
QBP-242S (X2) EACH
QCP-R96E

TFL LAMINATES



AMBER
MC

CORDOVAN
CW

BASES



CYLINDER BASE
NO WIRE ACCESS

THIN PANEL BASE
NO WIRE ACCESS

FEATURES



FLAT RIM PROFILE
1 1/2" TOP THICKNESS

ALL PRICES ARE LIST PRICE

OCCASIONAL TABLES



ARWOOD™ TURNED LEG

- HPL laminate top, turned wood legs
- Amber and Cordovan finish
- Mitered rim profile

MAGAZINE TABLE
Q31N2040MGPLW

END TABLE
Q31N2424ENPLW



AMBER
MC

CORDOVAN
CW



BARRINGTON®

- Wood top, chamfered wood legs
- Cordovan finish
- Traditional mitered rim profile

MAGAZINE TABLE
Q50N2040MGW

END TABLE
Q50N2424ENW



CORDOVAN
CW



ROOSEVELT™

- Veneer
- Cordovan finish
- Traditional mitered rim profile
- Mitered base/cornice
- Scroll pulls in Antique Brass

MAGAZINE TABLE
Q51N2040MGLW

END TABLE
Q51N2424ENLW



CORDOVAN
CW

ALL PRICES ARE LIST PRICE



ESCALADE®

- Wood top, tapered wood legs
- Cordovan or Amber finish
- Tribeca rim profile

MAGAZINE TABLE

QECN2040MGW

END TABLE

QECN2424ENW



AMBER
MC

CORDOVAN
CW

GENERAL INFORMATION

Quick Delivery Program

Our most popular series and options are available to deliver to you in 10 days or less through our Quick Delivery program. We offer a wide variety of product solutions to outfit any space and coordinate with any style, for no upcharge. From private office and open plan areas to reception and collaborative spaces, our complete portfolio of Quick Delivery solutions offers endless possibilities, all delivered within 10 days or less.

Quick Delivery Ordering

We will not accept changes or cancellations for Quick Delivery orders. The Quick Delivery orders must contain only Quick Delivery models—submit a separate order for any products that are not included in the program. Remember that the time to complete the order is based on business days and does not include weekends or holidays. The day your order is placed with National counts as day zero.

Quick Delivery Quantities

Need 20 guest chairs in 10 business days or less? No problem, with our Quick Delivery program, we've got you covered. Need more than 20? Just give us a call, and we'll work with you to get what you need, when you need it. Once in a while, demand exceeds capacity. Then, orders are subject to availability.

Contact Information

National Office Furniture
1610 Royal Street
Jasper, Indiana 47546

To order literature, check order status, and check lead times on-line, please visit us at www.NationalOfficeFurniture.com.

Telephone: 800.482.1717
Fax: 812.482.8800
E-mail customer service: Service@NationalOfficeFurniture.com

For Quick Delivery lead-time when shipping to Canada, please contact Customer Service at 800.482.1717.

Ordering Procedures

For prompt delivery, all orders MUST include:

1. Purchase Order Number (on each page of order)
2. Billing Address
3. "Ship To" Information
4. Special Shipping Instructions (requested ship or delivery dates, ship complete or split shipments, and tags if applicable)
5. Complete Model Numbers
6. Net Price

National does not accept orders verbally. Fax or e-mail orders directly to:

Fax: 812.482.8800
E-mail: Orders@NationalOfficeFurniture.com
(This e-mail requires an attached PDF order. General correspondence should go through Service@NationalOfficeFurniture.com.)

Ordering Confirmation

All complete orders will be acknowledged with ship dates upon entry of a clean, credit approved order into our system. This acknowledgment is the final agreement between National and the customer superseding all previous communications regarding the order.

NOTE: Please examine this acknowledgment carefully and advise National immediately of any discrepancies.

Changes and Cancellations

We regret that changes and cancellations are not possible once your order is entered into our system. In order to support our lead time commitments, orders are scheduled into our production cycle immediately upon order entry.

This includes changes/cancellations to:

- Quick Delivery Casegoods
- Made-to-Order Casegoods
- Engineered-to-Order (ETO) Casegoods

Please contact customer service for assistance.

Terms and Pricing

- Prices in this guide are list price for shipment within the continental United States; for Canadian pricing, please reference www.NationalOfficeFurniture.com
- Price subject to change without prior notice
- Merchandise will be billed at prices prevailing at time of placing order

- Distribution of this price list does not itself constitute an offer to sell
- Orders can be received only from authorized National Dealers

Product Design

National reserves the right to make changes in design, specifications, and construction and to discontinue products without prior notice. Dimensions referenced in this book are nominal.

WARRANTY

National warrants that each piece of furniture will be free from defects in workmanship given normal use and care for as long as the original customer owns and uses the product. This warranty is valid only if the product is given proper care and maintenance.

Normal use is defined as the equivalent of a single shift, 40 hour work week.

National, at its option, will repair or replace with comparable product any product, part or component, if the claim is eligible under the conditions of this warranty.

Limitations to this warranty include:

Twelve Years: Wood Chair Frames
Products used in multi-shift applications

Ten Years: Wood Veneers and Laminates

Five Years: Mechanical and High Wear Parts such as: Electrical Components, Textiles, Foam, Covering Materials, and Decorative Trim

Exclusions

This warranty does not apply to:

- Damage caused by a carrier
- Normal wear and tear which is to be expected during the period of ownership
- Appearance, durability, quality, behavior, colorfastness, or any other attribute of COM (Customer's Own Materials) or any other non-standard National material (including Arc-Com, Stinson, Maharam, Momentum, and Ultrafabrics) specified by the customer after application to a National product
- Color, grain, or texture of wood, laminate, and other covering materials
- Non-compliance with installation and maintenance instructions
- Damages or failures resulting from modifications, alterations, misuse, abuse, negligence, or improper care and maintenance of our products

Please follow the procedures described below to process warranty issues:

1. Contact National Customer Service (800.482.1717) and provide them with the serial number from the product in question and the purchase order number or acknowledgement number and a detailed description of the warranty issue. **Serial numbers are mandatory before the claim can be processed.**
2. Customer Service will determine and pre-approve all resolutions to the claim such as replacement units, service parts, labor, and repair charges. Upon approval, resolutions will be assigned an authorization number.
3. The authorization number must be included on all invoices for reimbursement. Any unauthorized charges will not be the responsibility of National.

As the manufacturer of your furniture, we stand behind our craftsmanship and pledge to do everything we can to resolve any problems you may have within the terms of this warranty as quickly as possible.

There are no other warranties except as expressly set forth here, either expressed or implied including any warranty of merchantability or fitness for any particular purpose. We exclude and will not pay consequential or incidental damages under this warranty.

NATIONAL®

1610 ROYAL STREET, JASPER, IN 47546

TOLL FREE 800.482.1717

WEB NATIONALOFFICEFURNITURE.COM

A BRAND OF KIMBALL INTERNATIONAL, ©2020

NBR0D20C