



10.03.22
PRICE LIST

QUICK DELIVERY SEATING

ACQUAINT

Product Specifications	24
Fabrics and Options	25
Product Pages	27

ACQUAINT

ACQUAINT PRODUCT SPECIFICATIONS

FRAME CONSTRUCTION

- Constructed of exterior beech with mortise and tenon joints that are securely glued for maximum joint stability
- Wall saving design feature on back legs
- Non-marring nylon glides

SEAT CONSTRUCTION

- 4" high grade polyurethane foam covers a plywood panel for added comfort and support
- Corner blocks screwed and glued in all 4 corners of the seat

BACK CONSTRUCTION (ALL MODELS)

- Features exterior rails and slats cut from beech wood

UPHOLSTERED BACK CONSTRUCTION

- ½" high grade polyurethane foam covers contoured panel for added support and comfort

ARMS

- Available with black protective polyurethane arm caps for added durability

EASY ACCESS CHAIR FOOT REST

- ¾" x 2¾" (19mm x 70mm) full length foot rest, solid wood (Beech)
- Anti-slip material applied to top face

CONTRASTING FABRICS

- All models available with contrasting fabric

STITCH-IT

- All models available with Stitch-it option, except bariatric

FINISH

- A catalyzed top coat that resists denting, peeling and reactions to chemicals
- Can be cleaned with a damp cloth
- When specifying Brighton, Natural, and Sonoma finish, variation in color is acceptable due to the nature of wood characteristics

WOOD SPECIES

- Beech

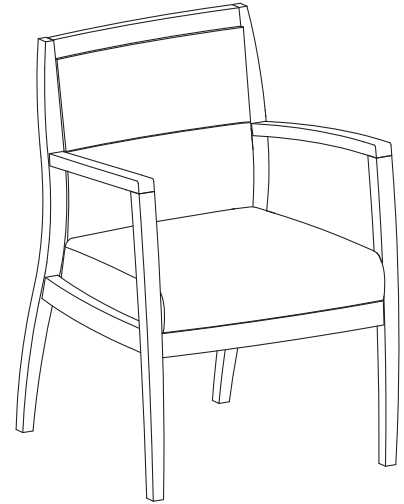

All Acquaint models may be ordered to meet TB133 fire code.

To order seating to meet the TB133 fire code, specify an "F" at the end of the model number (Ex: N59AAF).

For TB133 pricing go to
www.NationalOfficeFurniture.com/TB133

Please consult customer service for applicable Arc-Com, Carnegie, Designtex, Maharam, Mayer, Momentum, Stinson, or Ultrafabrics fabric.

FABRICS

Grade 1
 Cali
 Entwine
 Melange
 Ridge
 Spark
 Vessel
 Zig Zag

Grade 2
 Bliss
 Brilliant
 Dolce
 Intuition
 Orbit
 Pixie
 Sedona
 Stencil
 Strand

Grade 3
 Silvertex

Grade 4
 Connect Four
 Echo
 Masquerade

Grade 5
 Mode

Grade 6
 Essence/Ultraleather

Grade 7
 Brisa
 Brisa Distressed
 Reef Pro
 Silica
 Tottori

FINISHES

AC	Autumn	NM	Natural
AD	Almond	PB	Portobello
BZ	Brazilwood	PC	Porcini
CI	Chai	PT	Portico
CL	Caramel	SK	Skyline
CW	Cordovan	SM	Sonoma
DW	Judicial	TF	Truffle
HN	Honey	WL	Willow
IM	Brighton	405	Designer White
KN	Kona	462	Cinder
MC	Amber	792	Sable
MH	Mocha	793	Acorn*

*Acorn is the finish complement to Clear Walnut finish



Shaded models are available through our Quick Delivery program and will be delivered within 10 days or less. Shaded models that feature the 48 icon will ship within 48 hours (48). See page 6 for additional program information.

TO ORDER, SPECIFY:

1. Model Number
2. Fabric Grade Number
3. Cover Number
4. Finish Designator

• See page 25 for Acquaint options
See pages 31-32 for COM fabric yardage

HALF UPHOLSTERED

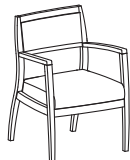

N59AA



N59AL

MODEL NO.

GRADE / LIST PRICE

			1	2/COM	3/COL	4	5	6	7	L7	L8
QN59AA	Arms	\$	1395	1427	1441	1464	1490	1533	1590		
QN59AL	Armless		1342	1374	1388	1411	1437	1480	1537		

DIMENSIONS

Width	24	Seat Height	18½	Arm Height	27	Arm Weight	34
Depth	24	Seat Depth	19½	Back Height	17¼	Armless Weight	33
Height	34	Seat Width	20¾	Back Width	17½	Cubic Ft.	15.5

ACQUAINT



Shaded models are available through our Quick Delivery program and will be delivered within 10 days or less. Shaded models that feature the 48 icon will ship within 48 hours (48). See page 6 for additional program information.

TO ORDER, SPECIFY:

1. Model Number
2. Fabric Grade Number
3. Cover Number
4. Finish Designator

• See page 25 for Acquaint options
See pages 31-32 for COM fabric yardage

FULLY UPHOLSTERED BACK

MODEL NO.

GRADE / LIST PRICE



N59BB



N59BL

		1	2/COM	3/COL	4	5	6	7	L7	L8
QN59BB	Arms	1475	1517	1536	1567	1601	1659	1735		
QN59BL	Armless	1423	1465	1484	1515	1549	1607	1683		

DIMENSIONS

Width	24	Seat Height	18½	Arm Height	27	Arm Weight	36
Depth	24	Seat Depth	18¾	Back Height	17¾	Armless Weight	35
Height	34	Seat Width	20¾	Back Width	17½	Cubic Ft.	15.5

ADMIRE

Product Specifications	34
Fabrics and Options	35
Product Pages	37

ADMIRE

ADMIRE PRODUCT SPECIFICATIONS

FRAME CONSTRUCTION

- Constructed of exterior beech with mortise and tenon joints that are securely glued for maximum joint stability
- Non-marring nylon glides

SEAT CONSTRUCTION

- 2" high grade polyurethane foam covers a plywood panel with high tension strip webbing for comfort
- Corner blocks screwed and glued in all 4 corners of the seat

BACK CONSTRUCTION (ALL MODELS)

- Features exterior rails and/or slats cut from steam bent beech wood

BACK CONSTRUCTION (N55AA, N55BB, N55EE, N55HH MODELS)

- 1" high grade polyurethane foam covers the front of a molded contour plywood back for support and comfort
- The outer (extreme) back features ½" of high grade polyurethane foam

CONTRASTING FABRICS

- All models available with contrasting fabric

STITCH-IT

- All models available with Stitch-it option

FINISH

- A catalyzed top coat resists denting, peeling, and reactions to chemicals
- Can be cleaned with a damp cloth
- When specifying Brighton, Natural, and Sonoma finish, variation in color is acceptable due to the nature of wood characteristics

WOOD SPECIES

- Beech

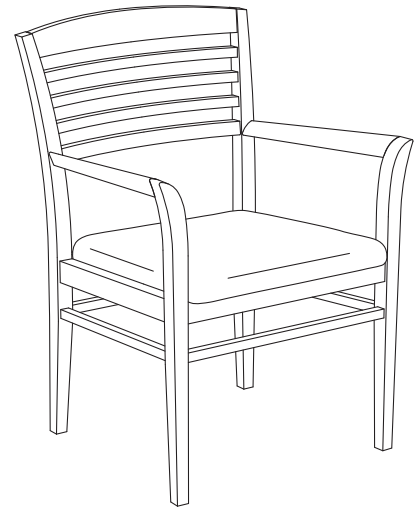

All Admire models may be ordered to meet TB133 fire code.

To order seating to meet the TB133 fire code, specify an "F" at the end of the model number (Ex: N55AAF).

For TB133 pricing go to www.NationalOfficeFurniture.com/TB133

Please consult customer service for applicable Arc-Com, Carnegie, Designtex, Maharam, Mayer, Momentum, Stinson, or Ultrafabrics fabric.

FABRICS

Grade 1
 Cali
 Entwine
 Melange
 Ridge
 Spark
 Vessel
 Zig Zag

Grade 2
 Bliss
 Brilliant
 Dolce
 Intuition
 Orbit
 Pixie
 Sedona
 Stencil
 Strand

Grade 3
 Silvertex

Grade 4
 Connect Four
 Echo
 Masquerade

Grade 5
 Mode

Grade 6
 Essence/Ultraleather

Grade 7
 Brisa
 Brisa Distressed
 Reef Pro
 Silica
 Tottori

FINISHES

AC	Autumn	NM	Natural
AD	Almond	PB	Portobello
BZ	Brazilwood	PC	Porcini
CI	Chai	PT	Portico
CL	Caramel	SK	Skyline
CW	Cordovan	SM	Sonoma
DW	Judicial	TF	Truffle
HN	Honey	WL	Willow
IM	Brighton	405	Designer White
KN	Kona	462	Cinder
MC	Amber	792	Sable
MH	Mocha	793	Acorn*

*Acorn is the finish complement to Clear Walnut finish





Shaded models are available through our Quick Delivery program and will be delivered within 10 days or less. Shaded models that feature the 48 icon will ship within 48 hours (48). See page 6 for additional program information.

TO ORDER, SPECIFY:

1. Model Number
2. Fabric Grade Number
3. Cover Number
4. Finish Designator

• See page 35 for Admire options
See page 39 for COM fabric yardage

GUEST FULLY UPHOLSTERED BACK

MODEL NO.

GRADE / LIST PRICE

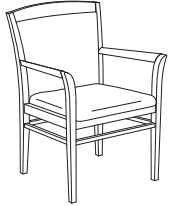

Arms

			1	2/COM	3/COL	4	5	6	7	L7	L8
QN55AA	Arms	\$	1226	1279	1303	1342	1384	1456	1552		

DIMENSIONS

Width	24	Seat Width	19¾	Arm Height	25¾	Arm Weight	32
Depth	24	Seat Depth	19½	Back Height	19	Armless Weight	30
Height	33¾	Seat Height	17½	Back Width	17¾	Arm Cubic Ft.	13.4
						Armless Cubic Ft.	14.6

ADMIRE

CINCH

GUEST

Product Specifications	62
Fabrics and Options	63
Product Pages	64
Guest/Stools	67

TASK

Product Specifications	68
Fabrics and Options	69
Product Pages	70

BEAM

Product Specifications	71
Fabrics and Options	72
Configurations	76
Product Pages	73

CINCH GUEST PRODUCT SPECIFICATIONS

FRAME CONSTRUCTION

- Legs are made of 1¼" x ⅝" thick steel for strength and durability
- Cross members are constructed of ¾" x 15-gauge thick steel
- Leg is joined to cross member bar with metal inert gas (MIG) welds
- Back support brackets utilize ⅝" thick steel plates

SEAT AND BACK CONSTRUCTION

- Contoured, injection molded polypropylene seat and back
- Seat and backrest are attached to the frame with screws

UPHOLSTERED SEAT CONSTRUCTION

- ½" foam

ARM REST

- Die-cast aluminum arm upright covered with an (ABS) black plastic arm cap
- Can be easily installed or removed with an Allen wrench

STANDARD AND OVERSIZED TABLET ARMS

- Black 3D Laminate MDF hinged surface with radius edge mounted on V-shaped arm rest
- Available as left-handed or right-handed
- Can be easily installed or removed with an Allen wrench

GANGING BRACKET–STACKER

- Chair is equipped with simple to align and easy to assemble ganging device; works for ganging non-mobile armless to armless
- Separate metal ganging bracket (N45GB) can be specified when ganging non-mobile arm, armless, or tablet arm models
- N45GB comes with a display card for row and seat indication
- Ganging not recommended for mobile models
- Offered in black only

BOOKRACK

- Made of ⅝" and ¼" steel wire
- For convenient storage use, installs easily with simple clip-on method
- Offered in black only

GLIDES

- Durable hard black nylon glides are standard
- Become scratch-resistant protectors when stacking chairs
- Soft glides are available for an additional upcharge

CASTERS

- Durable casters work on multiple surfaces

TRANSPORT DOLLY

- 1" x 16-gauge tubular steel handle, 1¼" x 16-gauge tubular steel base
- 4" wheels with locks
- Foldable handle allows for storage
- Transport dolly not necessary for mobile models

FINISH

- Cinder and Platinum Metallic frames are finished with electrostatically baked-on powder coat paint

STACKING CAPABILITIES

CINCH MODEL	STACKED ON FLOOR	STACKED ON DOLLY
Plastic Stacker	15 High	12 High
Plastic Stacker w/Arms	5 High	N/A
Plastic Stacker w/ Small Tablet Arm	4 High	Not Recommended
Plastic Stacker w/ Large Tablet Arm	Not Recommended	Not Recommended
Mobile Stacker	12 High	No Dolly Needed
Mobile Stacker w/Arms	4 High	N/A
Mobile Stacker w/ Small Tablet Arm	3 High	Not Recommended
Mobile Stacker w/ Large Tablet Arm	Not Recommended	Not Recommended
Plastic Stacker w/Arms Upholstered Seats	Stacking Not Recommended	Stacking Not Recommended

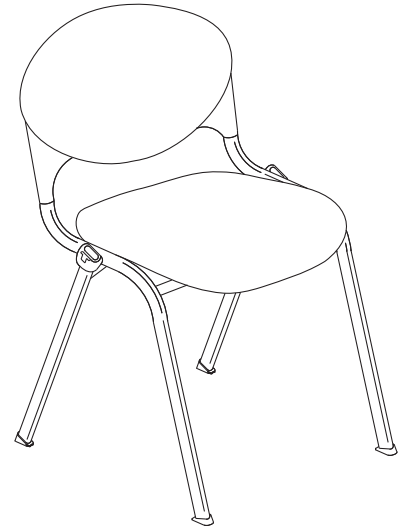

All Cinch models meet TB133 fire code. No special indicator or upcharge required for plastic models. To order upholstered models to meet the TB133 fire code, specify an "F" at the end of the model number (Ex: N45AUF). For TB133 pricing go to www.NationalOfficeFurniture.com/TB133 Please consult customer service for applicable Arc-Com, Carnegie, DesignTex, Maharam, Mayer, Momentum, Stinson, or Ultrafabrics fabric.

FABRICS

Grade 1 Cali
Entwine
Melange
Ridge
Spark
Vessel
Zig Zag

Grade 2 Bliss
Brilliant
Dolce
Intuition
Orbit
Pixie
Sedona
Stencil
Strand

Grade 3 Silvertex

Grade 4 Connect Four
Echo
Masquerade

Grade 5 Mode

Grade 6 Essence/Ultraleather

Grade 7 Brisa
Brisa Distressed
Reef Pro
Silica
Tottori

PLASTIC COLORS

P02 Red
P03 Blue
P06 Pebble
P07 Currant
P08 Marshmallow
P10 Black
P11 Blueberry
P12 Lemon
P14 Lime
P19 Brownie

FRAME COLORS

462 Cinder
501 Platinum Metallic

CASTERS

STD Hard (standard)
C4 Soft (add \$36 list per chair)

GLIDES

STD Standard
C30 Soft (add \$24 list per chair)



Shaded models are available through our Quick Delivery program and will be delivered within 10 days or less. Shaded models that feature the 48 icon will ship within 48 hours (48). See page 6 for additional program information.

TO ORDER, SPECIFY:

1. Model Number
2. Back Plastic Color
3. Seat Fabric Grade / Cover Number (when applicable)
4. Seat Plastic Color (when applicable)
5. Frame Color
6. Casters (mobile models only)
7. Glides (static models only)

• See page 63 for Cinch options
See page 77 for COM fabric yardage

**PLASTIC STACKER
ARMLESS**



Plastic Seat

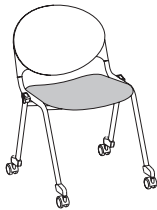

Upholstered Seat

**MODEL
NO.**

GRADE / LIST PRICE

QN45APR	Package of 1, Plastic, Static	\$	371										
QN45AP	Package of 4, Plastic, Static		1126										
QN45BPR	Package of 1, Plastic, Mobile	\$	499										
QN45BP	Package of 4, Plastic, Mobile		1520										

			1	2/COM	3/COL	4	5	6	7	L7	L8
QN45AUR	Package of 1, Upholstered, Static	\$	622	633	639	647	656	672	693		
QN45AU	Package of 4, Upholstered, Static		1890	1936	1956	1990	2027	2089	2172		
QN45BUR	Package of 1, Upholstered, Mobile	\$	752	763	769	777	786	802	823		
QN45BU	Package of 4, Upholstered, Mobile		2283	2329	2349	2383	2420	2482	2565		

DIMENSIONS

Width	21¾	Seat Height	18	Back Height	16½	Weight (1)	18
Depth	25¾	Seat Depth	17¾	Back Width	18½	Cubic Ft. (1)	13
Height	31	Seat Width	17¾			Weight (4) - Static	65
						Weight (4) - Mobile	72
						Cubic Ft. (4)	20

- Ordering (1) of model N45BP or N45BU will result in (1) carton being shipped, containing (4) chairs
- Pricing, weight and cubic ft. shown are per carton
- Each carton must have the same options
- Caster model not recommended for ganging
- Platinum Metallic frame option available for a \$42 list upcharge per chair (\$168 for package of 4)
- Soft glide option available for a \$24 list upcharge per chair (\$96 for package of 4)
- Soft caster option available for a \$36 list upcharge per chair (\$144 for package of 4)

TRANSPORT DOLLY

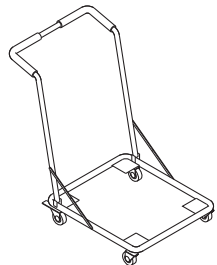

N45TD	Black	\$	671
-------	-------	----	-----

DIMENSIONS

Width	25¾	Weight	31
Depth	35½	Cubic Ft.	4.28
Height	38¾		

- Specify model number only
- For use with non-mobile plastic stacker
- Transport dolly is not needed for the mobile stacker; the weight of the stacked chairs will engage the casters for easy transport



Shaded models are available through our Quick Delivery program and will be delivered within 10 days or less. Shaded models that feature the 48 icon will ship within 48 hours (48). See page 6 for additional program information.

TO ORDER, SPECIFY:

• See page 63 for Cinch options

1. Model Number

ARMS

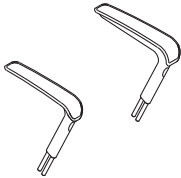

MODEL NO.

LIST PRICE

N45MAR	Platinum Metallic	\$ 219	Package of 1 Pair
N45MA	Platinum Metallic	718	Package of 4 Pairs
N45MMR	Cinder	180	Package of 1 Pair
N45MM	Cinder	539	Package of 4 Pairs

DIMENSIONS (Installed on Chair)

Width	22½	Seat Height	18	Seat Width	17¾	Weight (1)	5
Depth	25¼	Seat Depth	17¾	Arm Height	26	Cubic Ft. (1)	0.5
Height	31					Weight (4)	12
						Cubic Ft. (4)	0.73

- Ordering (1) of model N45MA or N45MM will result in (1) carton being shipped, containing (4) arm sets
- Pricing, weight and cubic ft. shown are per carton
- For use with Cinch stacking chair

STANDARD TABLET ARM

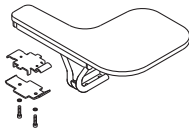

N45RTR	Right-Handed (as seated)	\$ 262	Package of 1
N45RT	Right-Handed (as seated)	785	Package of 4
N45LTR	Left-Handed (as seated)	262	Package of 1
N45LT	Left-Handed (as seated)	785	Package of 4

DIMENSIONS (Installed on Chair)

Width	25	Seat Height	18	Seat Width	17¾	Weight (1)	11
Depth	28	Seat Depth	17¾	Arm Height	28½	Cubic Ft. (1)	0.81
Height	31					Weight (4)	44
						Cubic Ft. (4)	2.5

- Ordering (1) of model N45RT or N45LT will result in (1) carton being shipped, containing (4) tablets
- P-shaped writing surface is 14¼" W x 10½" D
- Pricing, weight and cubic ft. shown are per carton
- Available in black only
- For use with Cinch stacking chair

OVERSIZED TABLET ARM

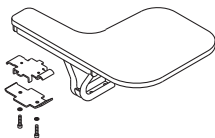

N45RT2R	Right-Handed (as seated)	\$ 391	Package of 1
N45RT2	Right-Handed (as seated)	1186	Package of 4
N45LT2R	Left-Handed (as seated)	391	Package of 1
N45LT2	Left-Handed (as seated)	1186	Package of 4

DIMENSIONS (Installed on Chair)

Width	25	Seat Height	18	Seat Width	17¾	Weight (1)	13
Depth	29½	Seat Depth	17¾	Arm Height	28½	Cubic Ft. (1)	0.81
Height	31					Weight (4)	61
						Cubic Ft. (4)	2.5

- Ordering (1) of model N45RT2 or N45LT2 will result in (1) carton being shipped, containing (4) tablets
- Oversized P-shaped writing surface is 16½" W x 12" D
- Pricing, weight and cubic ft. shown are per carton
- Available in black only
- For use with Cinch stacking chair

CINCH

CINCH



Shaded models are available through our Quick Delivery program and will be delivered within 10 days or less. Shaded models that feature the 48 icon will ship within 48 hours (48). See page 6 for additional program information.

TO ORDER, SPECIFY:

• See page 63 for Cinch options

1. Model Number

BOOKCRACK

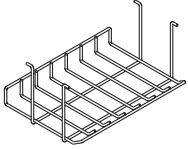

MODEL NO.

LIST PRICE

N45BKR	Black	\$ 120	Package of 1
N45BK	Black	361	Package of 4

DIMENSIONS

Width	17	Weight (1)	4
Depth	12¼	Cubic Ft. (1)	0.5
Height	7¾	Weight (4)	10
		Cubic Ft. (4)	1.5

- Ordering (1) of model N45BK will result in (1) carton being shipped, containing (4) bookcracks
- Pricing, weight and cubic ft. shown are per carton
- For use with Cinch stacking chair

GANGING BRACKET

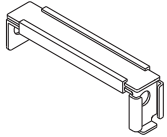

N45GB	Black	\$ 376	Package of 20
-------	-------	--------	---------------

DIMENSIONS

Width	4½	Weight	6
Depth	1	Cubic Ft.	0.10
Height	1½		

- For use with non-mobile plastic stacker
- Only required if ganging arm or tablet models or in case additional space is needed between armless models
- Ordered and shipped (20) ganging brackets per carton
- Pricing, weight and cubic ft. shown are per carton
- Ordering (1) of model N45GB will result in (1) carton being shipped, containing (20) ganging brackets
- Bracket features a label for chair numbering



Shaded models are available through our Quick Delivery program and will be delivered within 10 days or less. Shaded models that feature the 48 icon will ship within 48 hours (48). See page 6 for additional program information.

TO ORDER, SPECIFY:

1. Model Number
2. Back Plastic Color
3. Seat Fabric Grade / Cover Number (when applicable)
4. Seat Plastic Color (when applicable)
5. Frame Color
6. Glides (static models only)

• See page 63 for Cinch options
See page 77 for COM fabric yardage

COUNTER HEIGHT STOOL



Plastic Back
Plastic Seat

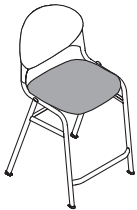

Plastic Back
Upholstered Seat

MODEL NO.

GRADE / LIST PRICE

PLASTIC

QN45CCP	Package of 1	\$	675								
QN45CC2P	Package of 2		1351								

UPHOLSTERED SEAT

			1	2/COM	3/COL	4	5	6	7	L7	L8
QN45CCU	Package of 1	\$	864	889	900	918	938	971	1016		
QN45CC2U	Package of 2		1727	1752	1763	1781	1801	1834	1879		

DIMENSIONS

Width	20%	Seat Height	24%	Back Height	17%	Weight (1)	25
Depth	21%	Seat Depth	17%	Back Width	19	Cubic Ft. (1)	12.2
Height	38%	Seat Width	17%			Weight (2)	42
						Cubic Ft. (2)	14.7

- Platinum Metallic frame option available for a \$50 list upcharge per chair
- Stools cannot be used with arms, tablet arms, bookracks or ganging brackets
- Soft glide option available for a \$24 list upcharge per chair

BAR HEIGHT STOOL



Plastic Back
Plastic Seat

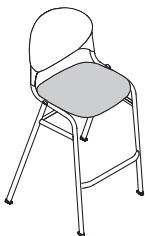

Plastic Back
Upholstered Seat

PLASTIC

QN45CBP	Package of 1	\$	675								
QN45CB2P	Package of 2		1351								

UPHOLSTERED SEAT

			1	2/COM	3/COL	4	5	6	7	L7	L8
QN45CBU	Package of 1	\$	864	889	900	918	938	971	1016		
QN45CB2U	Package of 2		1727	1752	1763	1781	1801	1834	1879		

DIMENSIONS

Width	20%	Seat Height	30%	Back Height	17	Weight (1)	27
Depth	22%	Seat Depth	17%	Back Width	19	Cubic Ft. (1)	16.5
Height	44%	Seat Width	17%			Weight (2)	46
						Cubic Ft. (2)	19.5

- Platinum Metallic frame option available for a \$50 list upcharge per chair
- Stools cannot be used with arms, tablet arms, bookracks or ganging brackets
- Soft glide option available for a \$24 list upcharge per chair

CINCH TASK PRODUCT SPECIFICATIONS**FRAME CONSTRUCTION**

- Frame is made of 1¼" x ⅝" thick steel for strength and durability
- Seat pan frame constructed of 10-gauge thick steel
- Back support brackets utilize ⅝" thick steel plates

SEAT AND BACK CONSTRUCTION

- Contoured, injection molded polypropylene seat and back
- Seat and backrest are attached to the frame with screws

UPHOLSTERED SEAT CONSTRUCTION

- ½" foam

ARM REST

- Die-cast aluminum arm upright covered with an (ABS) black plastic arm cap

CONTROL

- Swivel control
- The pneumatic gas cylinder lift allows the seat to raise and lower

BASE AND CASTERS

- Nylon 5-prong base features glass filled nylon for beauty and a long life
- Black, hard double wheel casters, which work on multiple surfaces, are standard
- Black, soft double wheel casters are available for use on hard floors; upcharge applies to this option
- Platinum Metallic option features a cast aluminum base

FINISH

- Cinder and Platinum Metallic frames are finished with electrostatically baked-on powder coat paint

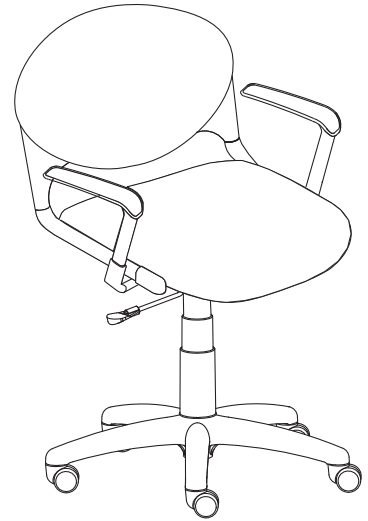

All Cinch Task models may be ordered to meet TB133 fire code.

To order seating to meet the TB133 fire code, specify an "F" at the end of the model number (Ex: N45HUF).

For TB133 pricing go to www.NationalOfficeFurniture.com/TB133

Please consult customer service for applicable Arc-Com, Carnegie, Designtex, Maharam, Mayer, Momentum, Stinson, or Ultrafabrics fabric.

FABRICS

Grade 1 Cali
Entwine
Melange
Ridge
Spark
Vessel
Zig Zag

Grade 2 Bliss
Brilliant
Dolce
Intuition
Orbit
Pixie
Sedona
Stencil
Strand

Grade 3 Silvertex

Grade 4 Connect Four
Echo
Masquerade

Grade 5 Mode

Grade 6 Essence/Ultraleather

Grade 7 Brisa
Brisa Distressed
Reef Pro
Silica
Tottori

PLASTIC COLORS

P02 Red
P03 Blue
P06 Pebble
P07 Currant
P08 Marshmallow
P10 Black
P11 Blueberry
P12 Lemon
P14 Lime
P19 Brownie

FRAME COLORS

462 Cinder
501 Platinum Metallic

CASTERS

C15 Hard (standard)
C2 Soft (add \$36 list)





Shaded models are available through our Quick Delivery program and will be delivered within 10 days or less. Shaded models that feature the 48 icon will ship within 48 hours (48). See page 6 for additional program information.

TO ORDER, SPECIFY:

1. Model Number
2. Back Plastic Color
3. Seat Fabric Grade / Cover Number (when applicable)
4. Seat Plastic Color (when applicable)
5. Frame Color
6. Casters

• See page 69 for Cinch options
See page 77 for COM fabric yardage

TASK	MODEL NO.	GRADE / LIST PRICE											
 Arms - Plastic Back Plastic Seat	PLASTIC												
	QN45HP	Arms		\$	884								
	QN45HPL	Armless			716								
 Armless - Plastic Back Upholstered Seat	UPHOLSTERED SEAT												
					1	2/COM	3/COL	4	5	6	7	L7	L8
	QN45HU	Arms	\$	1069	1080	1086	1094	1103	1119	1140			
QN45HUL	Armless		901	912	918	926	935	951	972				
DIMENSIONS													
Arm Width	24¾	Seat Height	15¾-20¾	Arm Height	23¾-28¾	Arm Weight	31						
Armless Width	24¾	Seat Depth	17¾	Back Height	16½	Armless Weight	27						
Depth	23¾	Seat Width	17¾	Back Width	18½	Cubic Ft.	14.3						
Height	29¾-34¾												
• Platinum Metallic frame option with cast aluminum base available for a \$158 list upcharge													

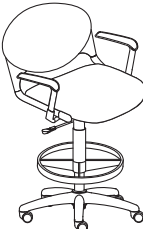
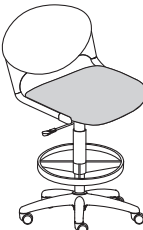
TASK STOOL	MODEL NO.	GRADE / LIST PRICE											
 Arms - Plastic Back Plastic Seat	PLASTIC												
	QN45JP	Arms	\$	1069									
	QN45JPL	Armless		901									
 Armless - Plastic Back Upholstered Seat	UPHOLSTERED SEAT												
					1	2/COM	3/COL	4	5	6	7	L7	L8
	QN45JU	Arms	\$	1253	1264	1270	1278	1287	1303	1324			
QN45JUL	Armless		1085	1096	1102	1110	1119	1135	1156				
DIMENSIONS													
Arm Width	24¾	Seat Height	21¾-31¾	Arm Height	29¾-39¾	Arm Weight	41						
Armless Width	24¾	Seat Depth	17¾	Back Height	16½	Armless Weight	36						
Depth	23¾	Seat Width	17¾	Back Width	18½	Cubic Ft.	16.7						
Height	36¾-46¾												
• Platinum Metallic frame option with cast aluminum base available for a \$158 list upcharge													

CINCH BEAM PRODUCT SPECIFICATIONS

BEAM FRAME CONSTRUCTION

- Frame features 1½" x 3¼" rectangular steel tube for strength and durability
- Leg uprights feature 1½" x 3¼" oval steel tube

CHAIR KIT CONSTRUCTION

- Frame is made of 1¼" x ⅝" thick steel for strength and durability
- Cross members are constructed of ¾" x 15-gauge thick steel
- Back support brackets utilize ⅝" thick steel plates

SEAT AND BACK CONSTRUCTION

- Contoured, injection molded polypropylene seat and back
- Seat features metal attachment plate for strength and durability
- Backrest is attached to the frame with screws

UPHOLSTERED SEAT CONSTRUCTION

- ½" foam

ARM REST

- Die-cast aluminum arm upright covered with a black urethane arm cap

TABLET ARMS

- ¾" thick black laminated MDF hinged surface mounted on die-cast aluminum V-shaped arm rest
- 21" W x 13½" D writing surface
- Available as right-handed only

TABLE

- ¾" thick black 3D Laminate MDF surface
- 17¾" x 17¾" writing surface

GLIDES

- Durable hard black nylon adjustable glides are standard
- Soft glides are available for an additional upcharge

FINISH

- Cinder and Platinum Metallic frames are finished with electrostatically baked-on powder coat paint

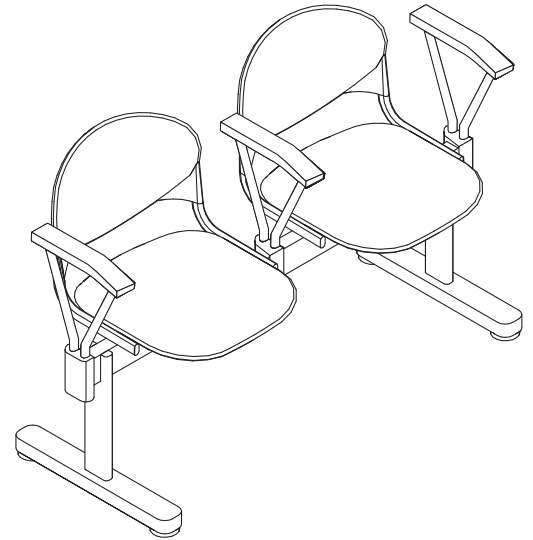

All Cinch Beam models may be ordered to meet TB133 fire code.

To order seating to meet the TB133 fire code, specify an "F" at the end of the model number (Ex: N45U1F).

For TB133 pricing go to www.NationalOfficeFurniture.com/TB133

Please consult customer service for applicable Arc-Com, Carnegie, Designtex, Maharam, Mayer, Momentum, Stinson, or Ultrafabrics fabric.

CINCH

FABRICS

Grade 1	Cali
	Entwine
	Melange
	Ridge
	Spark
	Vessel
	Zig Zag

Grade 2	Bliss
	Brilliant
	Dolce
	Intuition
	Orbit
	Pixie
	Sedona
	Stencil
	Strand

Grade 3	Silvertex
---------	-----------

Grade 4	Connect Four
	Echo
	Masquerade

Grade 5	Mode
---------	------

Grade 6	Essence/Ultraleather
---------	----------------------

Grade 7	Brisa
	Brisa Distressed
	Reef Pro
	Silica
	Tottori

PLASTIC COLORS

P02	Red
P03	Blue
P06	Pebble
P07	Currant
P08	Marshmallow
P10	Black
P11	Blueberry
P12	Lemon
P14	Lime
P19	Brownie

FRAME COLORS

462	Cinder
501	Platinum Metallic



Shaded models are available through our Quick Delivery program and will be delivered within 10 days or less. Shaded models that feature the 48 icon will ship within 48 hours (48). See page 6 for additional program information.

TO ORDER, SPECIFY:

• See page 72 for Cinch options

1. Model Number

2-SEAT BEAM

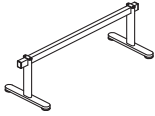

MODEL NO.

LIST PRICE

N45K2B	Black	\$ 758
N45K2P	Platinum Metallic	792

DIMENSIONS

Width	48	Weight	23.5
Depth	23	Cubic Ft.	1.25

- Beams can be configured by using any combination of chair, table, tablet and arm kits

3-SEAT BEAM

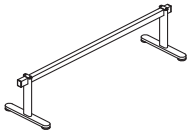

N45K3B	Black	\$ 1093
N45K3P	Platinum Metallic	1145

DIMENSIONS

Width	72	Weight	25
Depth	23	Cubic Ft.	1.35

- Beams can be configured by using any combination of chair, table, tablet and arm kits

4-SEAT BEAM

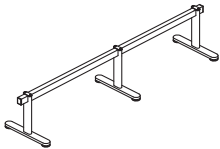

N45K4B	Black	\$ 1430
N45K4P	Platinum Metallic	1482

DIMENSIONS

Width	96	Weight	35
Depth	23	Cubic Ft.	2.21

- Beams can be configured by using any combination of chair, table, tablet and arm kits

5-SEAT BEAM

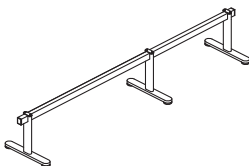

N45K5B	Black	\$ 1763
N45K5P	Platinum Metallic	1816

DIMENSIONS

Width	120	Weight	37
Depth	23	Cubic Ft.	2.32

- Beams can be configured by using any combination of chair, table, tablet and arm kits



Shaded models are available through our Quick Delivery program and will be delivered within 10 days or less. Shaded models that feature the 48 icon will ship within 48 hours (48). See page 6 for additional program information.

TO ORDER, SPECIFY:

1. Model Number
2. Back Plastic Color
3. Seat Fabric Grade / Cover Number (when applicable)
4. Seat Plastic Color (when applicable)
5. Frame Color

• See page 72 for Cinch options
See page 77 for COM fabric yardage

BEAM CHAIR KITS

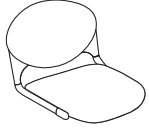

Plastic

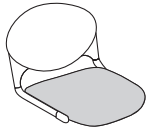

Upholstered

MODEL NO. GRADE / LIST PRICE

PLASTIC

QN45P1	1 - Chair Kit, Plastic	\$	461										
QN45P2	2 - Chair Kit, Plastic												927
QN45P3	3 - Chair Kit, Plastic												1388

UPHOLSTERED SEAT

		1	2/COM	3/COL	4	5	6	7	L7	L8
QN45U1	1 - Chair Kit, Upholstered	\$	589	600	606	614	623	639	660	
QN45U2	2 - Chair Kit, Upholstered		1178	1201	1211	1228	1246	1277	1319	
QN45U3	3 - Chair Kit, Upholstered		1763	1797	1813	1838	1865	1912	1975	

DIMENSIONS (Installed on Beam)

Height	32½	Seat Height	18¾	Back Height	16½	1 Chair Kit	
Depth	23	Seat Depth	17¾	Back Width	18½	Weight	18
		Seat Width	17¾			Cubic Ft.	6.7
						2 Chair Kit	
						Weight	33
						Cubic Ft.	7.7
						3 Chair Kit	
						Weight	47
						Cubic Ft.	8.8

- Platinum Metallic frame option available for a \$42 list upcharge, per chair; 1-Chair Kit = \$42, 2-Chair Kit = \$84, 3-Chair Kit = \$126
- Chairs attach to the beam, hardware included



Shaded models are available through our Quick Delivery program and will be delivered within 10 days or less. Shaded models that feature the 48 icon will ship within 48 hours (48). See page 6 for additional program information.

TO ORDER, SPECIFY:

• See page 72 for Cinch options

1. Model Number
2. Back Plastic Color
3. Seat Fabric Grade / Cover Number (when applicable)
4. Seat Plastic Color (when applicable)
5. Frame Color

BEAM ARM KIT

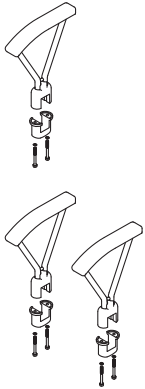

MODEL NO.

LIST PRICE

MODEL NO.	Description	LIST PRICE
N45MBB	Black, Package of 1	\$ 211
N45MCB	Black, Package of 2	421
N45MBP	Platinum Metallic, Package of 1	263
N45MCP	Platinum Metallic, Package of 2	473

DIMENSIONS (Installed on Beam)

Arm Height	26¾	1 Arm Kit	
		Weight	6
		Cubic Ft.	0.50
		2 Arm Kit	
		Weight	10
		Cubic Ft.	0.60

- Arms attach to the beam with U-bracket, included in kit

BEAM TABLET KIT

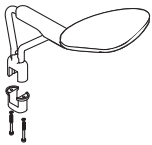

N45TB	Black	\$ 295
N45TP	Platinum Metallic	347

DIMENSIONS (Installed on Beam)

Tablet Height	28¾	Weight	11
		Cubic Ft.	0.81

- Tablet folds down to side of arm when not in use
- Right-handed tablet only
- Tablet arms attach to the beam with U-bracket, included in kit
- Tablet writing surface is 21" W x 13½" D

BEAM TABLE KIT

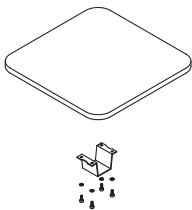

N45TAB	Black Bracket	\$ 461
N45TAP	Platinum Metallic Bracket	514

DIMENSIONS (Installed on Beam)

Table Height	18½	Weight	20
Table Width	17¾	Cubic Ft.	1.12
Table Depth	17¾		

- Tables attach to the beam with U-bracket, included in kit
- Black 3D Laminate surface

CINCH BEAM CONFIGURATIONS

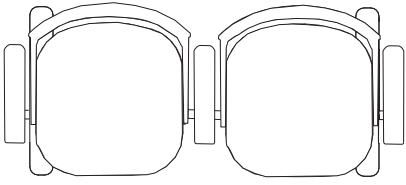

- 1) N45K2B 2-Seat Beam
 - 1) N45P2 2-Chair Kit - Plastic
 - 1) N45MBB Beam Arm Kit - package of 1
 - 1) N45MCB Beam Arm Kit - package of 2
-

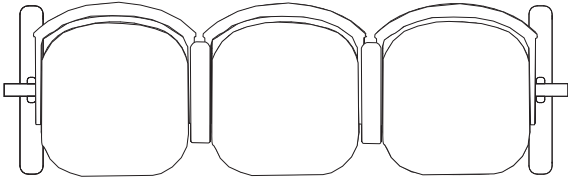

- 1) N45K3B 3-Seat Beam
 - 1) N45P3 3-Chair Kit - Plastic
 - 1) N45MCB Beam Arm Kit - package of 2
-

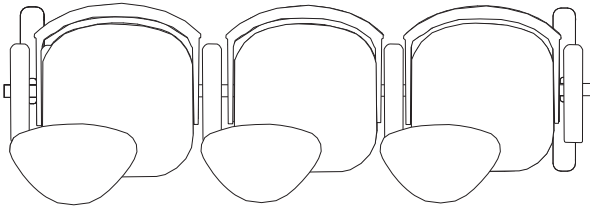

- 1) N45K3B 3-Seat Beam
 - 1) N45P3 3-Chair Kit - Plastic
 - 3) N45TB Beam Tablet Kit (right-handed only)
 - 1) N45MBB Beam Arm Kit - package of 1
-

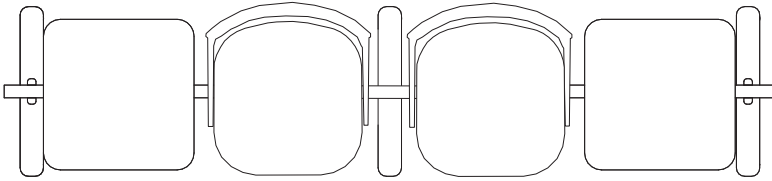

- 1) N45K4B 4-Seat Beam
 - 1) N45P2 2-Chair Kit - Plastic
 - 2) N45TAB Beam Table Kit
-

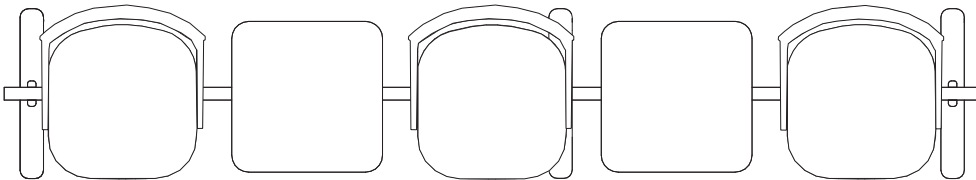

- 1) N45K5B 5-Seat Beam
- 1) N45P1 1-Chair Kit - Plastic
- 1) N45P2 2-Chair Kit - Plastic
- 2) N45TAB Beam Table Kit

COLLETTE

Product Specifications	80
Fabrics and Options	81
Product Pages	83

COLLETTE

COLLETTE PRODUCT SPECIFICATIONS

FRAME CONSTRUCTION

- Interior frame is constructed of oriented strand board with tenon joints that are glued and stapled for maximum joint stability
- Frames and table platforms are wrapped in high grade polyurethane foam, custom shaped, fabricated, and slip-covered

SEAT CONSTRUCTION

- Seat cushions are attached to frame and feature an 8½" cushion constructed of an inner steel springcoil pack enveloped by high grade polyurethane foam

BACK CONSTRUCTION

- Back pillows are attached to back frame and feature a recycled polyester filled insert
- Back and seat cushions are attached but replaceable

ARM CONSTRUCTION

- Arms are wrapped in high grade polyurethane foam, custom shaped, fabricated and slip-covered
- Arms are connected to frame using 4 bolts per arm

UPHOLSTERY DETAILS

- Top stitch is a French seam and is offered in matching or contrasting thread colors, except on tables
- Comfort wrinkles on the seat and back cushions are an inherent part of the design
- Contrasting fabric available on all models, except tables

TABLE TOP

- Laminate surfaces are 1¾" thick HPL (high pressure laminate) and feature standard 3mm PVC edge
- Solid surfaces are 1¾" thick and feature a flat rim profile

LEGS

- Extruded aluminum square legs offered in Concrete, Cinder, Iron, Polished Aluminum, Platinum Metallic, and Satin Nickel Metallic
- Wood square legs offered in all National seating finishes
- When specifying Brighton, Sonoma, and Natural finish, variation in color is acceptable due to the nature of wood characteristics
- U-Legs offered in Concrete, Cinder, Iron, Platinum Metallic, and Satin Nickel Metallic

GLIDES

- Features 1" adjustable nylon leveling glides
- Soft/non-skid 1" adjustable glides are available for an additional upcharge

POWER AND USB GROMMET

- UL Listed
- 4-Trac® non-sequential daisy chain, hardwire, or plug solutions available
- Features 1 power outlet and 1 USB A+C combo ports
- Grommet available in black, silver, and white
- Up to 20 4-Trac grommets can be linked together
- Field installable when CUT-G35 is specified
- 4-Trac grommet must be used with 4-Trac power entry and electrical kits
- Tamper resistant and spill proof

POWER AND USB GROMMET - UNDERMOUNT

- UL Listed
- Features 1 power outlet and 2 USB (A) ports
- Only available in black
- Field installable, unit can be placed on the underside of any flat surface

TOSS PILLOWS

- Please refer to pages 541-546 under the Toss Accent Pillows section to review complementary pillow options that work well with the Collette series

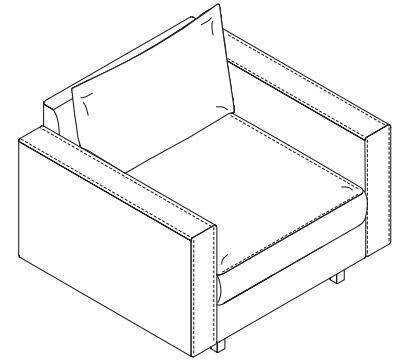

Dashed lines represent areas where matching or contrasting thread color is available

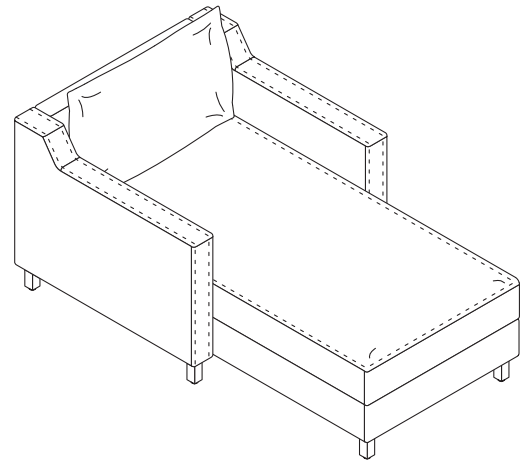

FABRICS

Grade 1	Cali Entwine Melange Ridge Spark Vessel Zig Zag
---------	---

Grade 2	Bliss Brilliant Dolce Intuition Orbit Pixie Sedona Stencil Strand
---------	---

Grade 3	Silvertex
---------	-----------

Grade 4	Connect Four Echo Masquerade
---------	------------------------------------

Grade 5	Mode
---------	------

Grade 6	Essence/Ultraleather
---------	----------------------

Grade 7	Brisa Brisa Distressed Reef Pro *Silica Tottori
---------	---

SQUARE LEG COLORS

METAL

S-462	Cinder
S-501	Platinum Metallic

WOOD

S-WAC	Autumn
S-WAD	Almond
S-WBZ	Brazilwood
S-WCI	Chai
S-WCL	Caramel
S-WCW	Cordovan
S-WDW	Judicial
S-WHN	Honey
S-WIM	Brighton
S-WKN	Kona
S-WMC	Amber
S-WMH	Mocha
S-WNM	Natural
S-WPB	Portobello
S-WPC	Porcini
S-WPT	Portico
S-WSK	Skyline
S-WSM	Sonoma
S-WTF	Truffle
S-WWL	Willow
S-W405	Designer White
S-W462	Cinder
S-W792	Sable
S-W793	Acorn*

*Acorn is the finish and laminate complement to Clear Walnut finish

THREAD COLORS

AA	Matching Thread
AB	White
AC	Beige
AD	Saddle
AG	Wine
AN	Black
AP	Buttercream
AQ	Tan
AR	Taupe
AS	Brown
AT	Rust
AU	Nickel
AV	Grey
AW	Cool Grey
AX	Scarlet
AY	Orange
AZ	Yellow
BA	Hunter
BB	Lime
BC	Turquoise
BD	Light Blue
BE	Royal
BF	Indigo
BG	Purple
BH	Pink

*Silica approved colors

70909	Cumulus
70912	Ginger
70915	Quartz
70917	Alloy
70919	Haze

GLIDES

STD	Standard
C66	Soft (add \$41 list)



Shaded models are available through our Quick Delivery program and will be delivered within 10 days or less. Shaded models that feature the 48 icon will ship within 48 hours (48). See page 6 for additional program information.

TO ORDER, SPECIFY:

1. Model Number
2. Fabric Grade / Cover Number
3. Thread Color
4. Grommet
5. Leg Color
6. Glides

- See page 81 for Collette options
- See pages 93-95 for COM fabric yardage

**1 SEAT LOUNGE
SQUARE LEG**

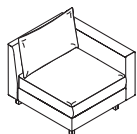

Straight Arm, Left

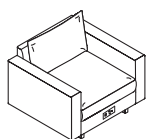

Straight Arms, Grommet

**MODEL
NO.**

GRADE / LIST PRICE

		1	2/COM	3/COL	4	5	6	7	L7	L8
STRAIGHT ARM										
QN84L1M	Armless	\$ 2730	2930	3021	3169	3329	3602	3967		
QN84L1A	Straight Arms	3233	3524	3656	3872	4105	4503	5034		

DIMENSIONS

Armless Width	30	Seat Height	18½	Arm Width		Armless Weight	66
Single Arm Width		Seat Depth	22	Straight	5½	Single Arm Weight	
Straight	35	Seat Width	30	Arm Height		Straight	84
Double Arm Width				Straight	25¼	Double Arm Weight	
Straight	40			Back Height	29	Straight	104
Depth	35¼					Armless Cubic Ft.	32.0
Height	34½					Single Arm Cubic Ft.	
						Straight	32.0
						Arms Cubic Ft.	
						Straight	33.8

- Grommet cutout option CUT-G35C is available

COLLETTE



Shaded models are available through our Quick Delivery program and will be delivered within 10 days or less. Shaded models that feature the 48 icon will ship within 48 hours (48). See page 6 for additional program information.

TO ORDER, SPECIFY:

1. Model Number
2. Fabric Grade / Cover Number
3. Thread Color
4. Grommet
5. Leg Color
6. Glides

• See page 81 for Collette options
See pages 93-95 for COM fabric yardage

**2 SEAT LOUNGE
SQUARE LEG**

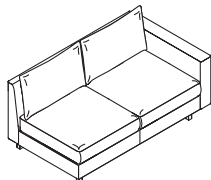

Straight Arm, Left

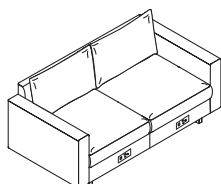

Straight Arms, Grommets

**MODEL
NO.**

GRADE / LIST PRICE

		1	2/COM	3/COL	4	5	6	7	L7	L8
STRAIGHT ARM										
QN84L2M	Armless	\$ 4382	4757	4928	5206	5506	6019	6704		
QN84L2A	Straight Arms	4884	5350	5562	5908	6281	6919	7770		

DIMENSIONS

Armless Width	60	Seat Height	18½	Arm Width		Armless Weight	137
Single Arm Width		Seat Depth	22	Straight	5½	Single Arm Weight	
Straight	65	Seat Width	60	Arm Height		Straight	155
Double Arm Width				Straight	25¼	Double Arm Weight	
Straight	70			Back Height	29	Straight	165
Depth	35¼					Armless Cubic Ft.	56.6
Height	34½					Single Arm Cubic Ft.	
						Straight	56.6
						Arms Cubic Ft.	
						Straight	50.9

• Grommet cutout options CUT-G35L, CUT-G35R, CUT-G35LR are available

COLLETTE

COLLETTE



Shaded models are available through our Quick Delivery program and will be delivered within 10 days or less. Shaded models that feature the 48 icon will ship within 48 hours (48). See page 6 for additional program information.

TO ORDER, SPECIFY:

1. Model Number
2. Fabric Grade / Cover Number
3. Thread Color
4. Grommet
5. Leg Color
6. Glides

• See page 81 for Collette options

See pages 93-95 for COM fabric yardage

3 SEAT LOUNGE SQUARE LEG

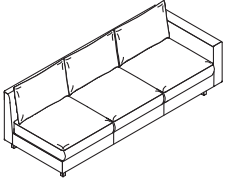

Straight Arm, Left

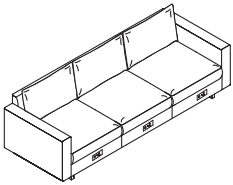

Straight Arms, Grommets

MODEL NO.

GRADE / LIST PRICE

		1	2/COM	3/COL	4	5	6	7	L7	L8
STRAIGHT ARM										
QN84L3M	Armless	\$ 5962	6512	6763	7171	7611	8364	9369		
QN84L3A	Straight Arms	6465	7106	7398	7874	8387	9265	10436		

DIMENSIONS

Armless Width	90	Seat Height	18½	Arm Width		Armless Weight	188
Single Arm Width		Seat Depth	22	Straight		Single Arm Weight	
Straight	95	Seat Width	90	Arm Height	5½	Straight	206
Double Arm Width				Straight	25¼	Double Arm Weight	
Straight	100			Back Height	29	Straight	225
Depth	35¼					Armless Cubic Ft.	68.5
Height	34½					Single Arm Cubic Ft.	
						Straight	80.2
						Arms Cubic Ft.	
						Straight	84.4

• All grommet cutout options are available



Shaded models are available through our Quick Delivery program and will be delivered within 10 days or less. Shaded models that feature the 48 icon will ship within 48 hours (48). See page 6 for additional program information.

TO ORDER, SPECIFY:

1. Model Number
2. Laminate (when applicable)
3. Solid Surface Grade/Color (when applicable)
4. Fabric Grade / Cover Number
5. Thread Color (when applicable)
6. Leg Color
7. Grommet
8. Glides

• See page 81 for Collette options
See pages 93-95 for COM fabric yardage

OTTOMAN SQUARE LEG

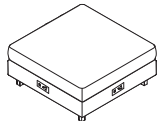

Grommets

MODEL NO.

GRADE / LIST PRICE

		1	2/COM	3/COL	4	5	6	7	L7	L8
QN84D1	Ottoman, 30", Square Leg	\$ 1796	1912	1964	2050	2143	2301	2512		
QN84D2	Ottoman, 36", Square Leg	2241	2364	2420	2511	2609	2777	3001		

30" DIMENSIONS

Width	30
Depth	30
Height	18½
Weight	52
Cubic Ft.	12.2

36" DIMENSIONS

Width	35¼
Depth	35¼
Height	18½
Weight	78
Cubic Ft.	17.3

• All grommet cutout options are available

COLLETTE

COLLETTE



Shaded models are available through our Quick Delivery program and will be delivered within 10 days or less. Shaded models that feature the 48 icon will ship within 48 hours (48). See page 6 for additional program information.

TO ORDER, SPECIFY:

• See page 81 for Collette options

1. Model Number

GANGING BRACKET

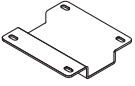

Ganging Bracket Kit

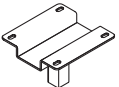

Leg Ganging Bracket Kit

MODEL NO.		LIST PRICE	CARTONED WEIGHT	CUBIC FEET
N84GK	Ganging Bracket Kit (2 Brackets)	\$ 123	2.5 lbs.	0.2
N84GKL	Leg Ganging Bracket Kit (2 Brackets With Legs)	209	3.0 lbs.	0.2
N84GKAL	Large Leg Ganging Bracket Kit (2 Brackets With Legs)	278	3.0 lbs.	0.2

- Ganging bracket kit includes required brackets to join 2 units together
- Leg ganging bracket kit allows the removal of front and back legs when ganging 2 units
- Large leg ganging bracket kit for intermediate arm ganging
- All bracket models provide wire management

CONFIDE

LOUNGE, FREESTANDING TABLES

Product Specifications	98
Fabrics and Options	99
Product Pages	101

GUEST, TANDEM, BARIATRIC, GANGING STARTERS AND TABLES, BENCHES

Product Specifications	105
Fabrics and Options	106
Product Pages	109

CONFIDE PRODUCT SPECIFICATIONS—LOUNGE, FREESTANDING TABLES

LOUNGE WITH UPHOLSTERED BACK PANELS

FRAME CONSTRUCTION

- Interior frame is constructed of plywood with tenon joints that are glued and stapled for maximum joint stability
- Welded leg assembly is screwed within the arm frame assembly
- 12-gauge back brackets are attached to the frame with wood screws

FULLY UPHOLSTERED BACK CONSTRUCTION

- 1" of high grade polyurethane foam covers a plywood back panel

EXPOSED WOOD BACK CONSTRUCTION

- 1" of high grade polyurethane foam covers a plywood back panel

SEAT CONSTRUCTION

- 3¼" of high grade polyurethane foam covers a plywood seat panel
- Easy clean wipe out feature

ARMS

- ¾" of high grade polyurethane foam covers a plywood constructed arm frame

CONTRASTING FABRIC

- Contrasting fabric available on all models

LEGS

- Front and back legs and cross member are made from 7⁄8" x 1¼" 16-gauge elliptical tubular steel. Cross member is joined to the front and back leg with metal inert gas (MIG) welds
- Wall saving design feature

TABLET ARM

- ¾" thick MDF core with black 3D Laminate or ¾" plywood core with maple veneer
- Attached with ¼" steel base plate and screws that mount over ¾" diameter insert rod and fits into structure of arm
- Allows for 360° swivel and writing surface of 14" W x 9½" D

GLIDES

- Front legs feature a 1" adjustable leveling glide
- Back legs feature a 1" adjustable 1" swivel leveling glide
- Soft glides are available for an additional upcharge

ARM CAPS

- Available with black protective polyurethane or decorative solid hard maple
- Arm cap is not an option on arm where tablet is specified
- Arm caps cannot be retrofitted to non-arm cap models
- Arm caps are field serviceable

FINISHES

- Concrete, Cinder, Iron, Platinum Metallic and Satin Nickel Metallic frames are finished with an electrostatic baked-on powder coat
- Wood components feature a catalyzed top coat that resists denting, peeling and reactions to chemicals
- Can be cleaned with a damp cloth
- When specifying Brighton, Natural, and Sonoma finish, variation in color is acceptable due to the nature of wood characteristics

WOOD SPECIES

- Hard maple

TABLES

FRAME CONSTRUCTION

- Table frame is made from 7⁄8" x 1¼" 16-gauge elliptical tubular steel
- Cross members are made from 7⁄8" 16-gauge round tubular steel
- Cross members are joined to the U-bent side members with metal inert gas (MIG) welds

TOPS

- Veneer models feature a ¾" molded laminated HDF core slipmatched maple veneer
- Laminate models feature a ¾" molded laminated HDF core with laminate (HPL) top

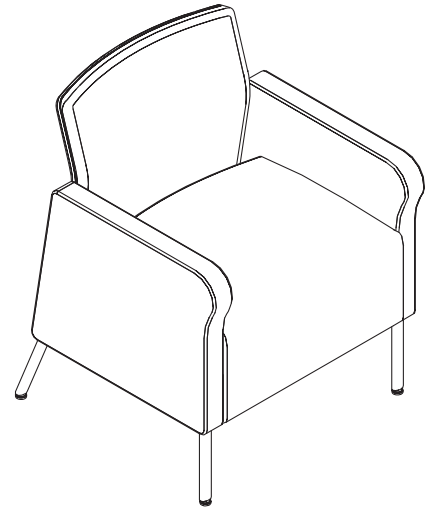

All Confide Lounge models may be ordered to meet TB133 fire code.
 To order seating to meet the TB133 fire code, specify an "F" at the end of the model number (Ex: N78LAUF).
 For TB133 pricing go to www.NationalOfficeFurniture.com/TB133
 Please consult customer service for applicable Arc-Com, Carnegie, Designtex, Maharam, Mayer, Momentum, Stinson, or Ultrafabrics fabric.

FABRICS

Grade 1	Cali Entwine Melange Ridge Spark Vessel Zig Zag
---------	---

Grade 2	Bliss Brilliant Dolce Intuition Orbit Pixie Sedona Stencil Strand
---------	---

Grade 3	Silvertex
---------	-----------

Grade 4	Connect Four Echo Masquerade
---------	------------------------------------

Grade 5	Mode
---------	------

Grade 6	Essence/Ultraleather
---------	----------------------

Grade 7	Brisa Brisa Distressed Reef Pro Silica Tottori
---------	--

ARM CAP

(\$125 upcharge per polyurethane arm cap,
\$213 upcharge per wood arm cap)

CAP_U	Polyurethane	CAP_NM	Natural
CAP_AC	Autumn	CAP_PB	Portobello
CAP_AD	Almond	CAP_PC	Porcini
CAP_BZ	Brazilwood	CAP_PT	Portico
CAP_CI	Chai	CAP_SK	Skyline
CAP_CL	Caramel	CAP_SM	Sonoma
CAP_CW	Cordovan	CAP_TF	Truffle
CAP_DW	Judicial	CAP_WL	Willow
CAP_HN	Honey	CAP_405	Designer White
CAP_IM	Brighton	CAP_462	Cinder
CAP_KN	Kona	CAP_792	Sable
CAP_MC	Amber	CAP_793	Acorn*
CAP_MH	Mocha	X	No Cap

*Acorn is the finish and laminate complement to Clear Walnut finish

LEG COLORS

462	Cinder
501	Platinum Metallic

GLIDES

STD	Standard
C10	Soft (add \$41 list)



Shaded models are available through our Quick Delivery program and will be delivered within 10 days or less. Shaded models that feature the 48 icon will ship within 48 hours (48). See page 6 for additional program information.

TO ORDER, SPECIFY:

1. Model Number
2. Fabric Grade Number
3. Fabric Cover Number
4. Tablet and Finish (when applicable)
5. Arm Cap (when applicable)
6. Wood Back Finish Color (when applicable)
7. Leg Color

• See page 99 for Confide options
See pages 117-118 for COM fabric yardage

1 SEAT LOUNGE



Upholstered

MODEL NO.

GRADE / LIST PRICE

		1	2/COM	3/COL	4	5	6	7	L7	L8
QN78LAU	Upholstered Back	\$ 3031	3143	3194	3277	3367	3521	3725		

DIMENSIONS

Width	27¼	Seat Height	18½	Arm Height	26	Weight	70
Depth	26¾	Seat Depth	19	Back Height	33¾	Cubic Ft.	21.8
Height	33¾	Seat Width	21½	Back Width	21½	Weight with Tablet	77
						Cubic Ft. with Tablet	21.8

- Arm cap is not an option on arm where tablet is specified
- Soft glide option available
- Polyurethane arm cap option available for a \$125 list upcharge per cap
- Wood arm cap option available for a \$213 list upcharge per cap

CONFIDE PRODUCT SPECIFICATIONS—GUEST, TANDEM, BARIATRIC, GANGING STARTERS AND TABLES, BENCHES

SIDE SEATING

SEAT CONSTRUCTION

- 2" of high grade polyurethane foam covers a plywood seat panel
- Easy clean wipe out feature

FULLY UPHOLSTERED BACK CONSTRUCTION

- 1" of high grade polyurethane foam covers a plywood back panel

EXPOSED WOOD BACK CONSTRUCTION

- 1" of high grade polyurethane foam covers a plywood back panel

ARMS

- Arms are die-cast aluminum available in Cinder, Platinum Metallic and Satin Nickel Metallic

FRAME CONSTRUCTION

- Frame is made from $\frac{7}{8}$ " x $1\frac{1}{4}$ " 16-gauge elliptical tubular steel
- Cross members are joined with metal inert gas (MIG) welds
- Wall saving design feature

CONTRASTING FABRIC

- Contrasting fabric available on all models except benches

ARM CAPS

- Black protective polyurethane is standard on all models
- Decorative solid hard maple cap option is available

GLIDES

- Front leg features a 1" adjustable leveling glide
- Back leg features a 1" adjustable swivel glide
- Soft glides are available for an additional upcharge

FINISHES

- Concrete, Cinder, Iron, Platinum Metallic and Satin Nickel Metallic frames are finished with an electrostatic baked-on powder coat
- Wood components feature a catalyzed top coat that resists denting, peeling and reactions to chemicals
- Can be cleaned with a damp cloth
- When specifying Brighton, Natural, and Sonoma finish, variation in color is acceptable due to the nature of wood characteristics

WOOD SPECIES

- Hard maple

TABLES

FRAME CONSTRUCTION

- Table frame is made from $\frac{7}{8}$ " x $1\frac{1}{4}$ " 16-gauge elliptical tubular steel
- Cross members are made from $\frac{7}{8}$ " 16-gauge round tubular steel
- Cross members are joined to the U-bent side members with metal inert gas (MIG) welds

TOPS

- Veneer models feature a $\frac{3}{4}$ " molded laminated HDF core slipmatched maple veneer
- Laminate models feature a $\frac{3}{4}$ " molded laminated HDF core with laminate (HPL) top

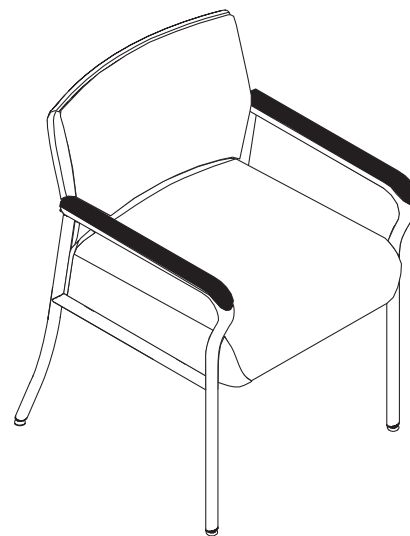

All Confide Side Seating models may be ordered to meet TB133 fire code.

To order seating to meet the TB133 fire code, specify an "F" at the end of the model number (Ex: N78GFAUF).

For TB133 pricing go to www.NationalOfficeFurniture.com/TB133

Please consult customer service for applicable Arc-Com, Carnegie, Designtex, Maharam, Mayer, Momentum, Stinson, or Ultrafabrics fabric.

FABRICS

Grade 1	Cali Entwine Melange Ridge Spark Vessel Zig Zag
---------	---

Grade 2	Bliss Brilliant Dolce Intuition Orbit Pixie Sedona Stancil Strand
---------	---

Grade 3	Silververtex
---------	--------------

Grade 4	Connect Four Echo Masquerade
---------	------------------------------------

Grade 5	Mode
---------	------

Grade 6	Essence/Ultraleather
---------	----------------------

Grade 7	Brisa Brisa Distressed Reef Pro Silica Tottori
---------	--

FINISHES

AC	Autumn	NM	Natural
AD	Almond	PB	Portobello
BZ	Brazilwood	PC	Porcini
CI	Chai	PT	Portico
CL	Caramel	SK	Skyline
CW	Cordovan	SM	Sonoma
DW	Judicial	TF	Truffle
HN	Honey	WL	Willow
IM	Brighton	405	Designer White
KN	Kona	462	Cinder
MC	Amber	792	Sable
MH	Mocha	793	Acorn*

POWDER COAT PAINTS

423	Concrete
462	Cinder
463	Iron
501	Platinum Metallic
503	Satin Nickel Metallic

GLIDES

STD	Standard
C10	Soft (add \$41 list)

ARM CAP

(\$87 upcharge per wood arm cap)

CAP_U	Polyurethane
CAP_AC	Autumn
CAP_AD	Almond
CAP_BZ	Brazilwood
CAP_CI	Chai
CAP_CL	Caramel
CAP_CW	Cordovan
CAP_DW	Judicial
CAP_HN	Honey
CAP_IM	Brighton
CAP_KN	Kona
CAP_MC	Amber
CAP_MH	Mocha
CAP_NM	Natural
CAP_PB	Portobello
CAP_PC	Porcini
CAP_PT	Portico
CAP_SK	Skyline
CAP_SM	Sonoma
CAP_TF	Truffle
CAP_WL	Willow
CAP_405	Designer White
CAP_462	Cinder
CAP_792	Sable
CAP_793	Acorn*

*Acorn is the finish and laminate complement to Clear Walnut finish

CONFIDE GANGING MATRIX

		N78SFAW / N78SFAU Starter, Arm, Wood or Uph Back	N78SFMW / N78SFMU Starter, Armless, Wood or Uph Back	N78T2AW / N78T2AU 2 Seat Tandem, Arms and Legs, Wood or Uph Back	N78B2AW / N78B2AU 2 Seat Tandem, Arms, No Center Leg Wood or Uph Back	N78B2EW / N78B2EU 2 Seat Tandem, No Center Arms or Leg, Wood or Uph Back	N78T3AW / N78T3AU 3 Seat Tandem, Arms and Legs, Wood or Uph Back	N78B3AW / N78B3AU 3 Seat Tandem, Arms, No Center Leg Wood or Uph Back	N78B3EW / N78B3EU 3 Seat Tandem, No Center Arms or Leg, Wood or Uph Back	N78AFLAW / N78AFLAU Guest Add-On, Left Arm/Leg, Wood or Uph Back	N78AFLMW / N78AFLMU Guest Add-On, Armless/Left Leg, Wood or Uph Back	N78AFRAW / N78AFRAU Guest Add-On, Right Arm/Leg, Wood or Uph Back	N78AFRWW / N78AFRWMU Guest Add-On, Armless/Right Leg, Wood or Uph Back	N78GEAW / N78GEAU Bariatric, Wood or Uph Back	N78TCW / N78TCL Table, Ganging Center, Wood or Lam	N78TEW / N78TEL Table, Ganging End, Wood or Lam	N78TNW / N78TNL Table, Ganging Corner, Wood or Lam	N78D1M Bench, 1 Seat, Armless	N78D2M / N78D2A Bench, 2 Seat, Arm, Armless	N78D3M / N78D3A Bench, 3 Seat, Arm, Armless
N78SFAW N78SFAU	Starter, Arm, Wood or Uph Back									X	X	X	X		X*	X	X*			
N78SFMW N78SFMU	Starter, Armless, Wood or Uph Back									X	X	X	X		X*	X	X*			
N78T2AW N78T2AU	2 Seat Tandem, Arms and Legs, Wood or Uph Back									X	X	X	X		X*	X	X*			
N78B2AW N78B2AU	2 Seat Tandem, Arms, No Center Leg Wood or Uph Back														X*	X	X*			
N78B2EW N78B2EU	2 Seat Tandem, No Center Arms or Leg, Wood or Uph Back														X*	X	X*			
N78T3AW N78T3AU	3 Seat Tandem, Arms and Legs, Wood or Uph Back									X	X	X	X		X*	X	X*			
N78B3AW N78B3AU	3 Seat Tandem, Arms, No Center Leg Wood or Uph Back														X*	X	X*			
N78B3EW N78B3EU	3 Seat Tandem, No Center Arms or Leg, Wood or Uph Back														X*	X	X*			
N78AFLAW N78AFLAU	Guest Add-On, Left Arm/Leg, Wood or Uph Back	X	X	X				X		X	X				X*	X	X*			
N78AFLMW N78AFLMU	Guest Add-On, Armless, Left Leg, Wood or Uph Back	X	X	X				X		X	X				X*	X	X*			
N78AFRAW N78AFRAU	Guest Add-On, Right Arm/Leg, Wood or Uph Back	X	X	X				X				X	X		X*	X	X*			
N78AFRWW N78AFRWMU	Guest Add-On, Armless, Right Leg, Wood or Uph Back	X	X	X				X				X	X		X*	X	X*			
N78GEAW N78GEAU	Bariatric, Wood or Uph Back														X*	X	X*			
N78TCW N78TCL	Table, Ganging Center, Wood or Lam	X*	X*	X*	X*	X*	X*	X*	X*	X*	X*	X*	X*	X*				X*	X*	X*
N78TEW N78TEL	Table, Ganging End, Wood or Lam	X	X	X	X	X	X	X	X	X	X	X	X	X				X	X	X
N78TNW N78TNL	Table, Ganging Corner, Wood or Lam	X*	X*	X*	X*	X*	X*	X*	X*	X*	X*	X*	X*	X*				X*	X*	X*
N78D1M	Bench, 1 Seat, Armless														X*	X	X*			
N78D2M N78D2A	Bench, 2 Seat, Arm, Armless														X*	X	X*			
N78D3M N78D3A	Bench, 3 Seat, Arm, Armless														X*	X	X*			

*Corner and center tables must be ganged between starter chairs, tandem seating, bariatric chairs or benches

- Non-Ganging models not in chart N78GFAW, N78GFAU, N78PAU.
- Tandem with no center legs, bariatric, and benches can only be ganged to tables
- Guest side and patient chairs cannot be ganged to other units
- No limit the number of add-on connections
- End and corner tables are non-handed
- Add-on models are listed as seated

CONFIDE



Shaded models are available through our Quick Delivery program and will be delivered within 10 days or less. Shaded models that feature the 48 icon will ship within 48 hours (48). See page 6 for additional program information.

TO ORDER, SPECIFY:

1. Model Number
2. Fabric Grade Number
3. Fabric Cover Number
4. Arm Cap (when applicable)
5. Arm Cap Finish (when applicable)
6. Wood Back Finish Color (when applicable)
7. Frame Color
8. Glides

• See page 106 for Confide options
See pages 117-118 for COM fabric yardage

GUEST



Upholstered



Upholstered



Wood Back

MODEL NO.

GRADE / LIST PRICE

		1	2/COM	3/COL	4	5	6	7	L7	L8
QN78GFMU	Armless, Upholstered Back	\$ 1731	1784	1808	1847	1889	1961	2057		
QN78GFMW	Armless, Wood Back	1948	1997	2019	2056	2095	2162	2252		
QN78GFAU	Arms, Upholstered Back	1861	1914	1938	1977	2019	2091	2187		
QN78GFAW	Arms, Wood Back	2078	2127	2149	2186	2225	2292	2382		

DIMENSIONS

Width	24	Seat Height	19	Arm Height	26¾	Armless Weight	46
Depth	23	Seat Depth	20	Back Height	33¾	Arm Weight	48
Height	33½	Seat Width	22½	Back Width	20¾	Cubic Ft.	16.3

- Polyurethane arm caps are standard. Wood arm cap option available for a \$87 list upcharge per cap
- Soft glide option available

DAVARI

Product Specifications	120
Fabrics and Options	121
Product Pages	123

DAVARI

DAVARI PRODUCT SPECIFICATIONS

GUEST SEATING

FRAME CONSTRUCTION

- Constructed of exterior steam bent beech with mortise and tenon joints that are securely glued for maximum joint stability
- Features an interior metal support frame for added strength
- Wall saving design feature on back legs
- Non-marring nylon glides

SEAT CONSTRUCTION

- 2" of custom molded, controlled density polyurethane foam covers a plywood panel with high tension strip webbing for comfort

BACK CONSTRUCTION

- 1¼" high grade polyurethane foam covers a contoured plywood panel for added support and comfort

CONTRASTING FABRICS

- Available with contrasting fabric

STITCH-IT

- All models available with Stitch-it option

FINISH

- Wood components feature a catalyzed top coat that resists denting, peeling and reactions to chemicals
- Can be cleaned with damp cloth
- When specifying Brighton, Natural, and Sonoma finish, variation in color is acceptable due to the nature of wood characteristics

WOOD SPECIES

- Beech

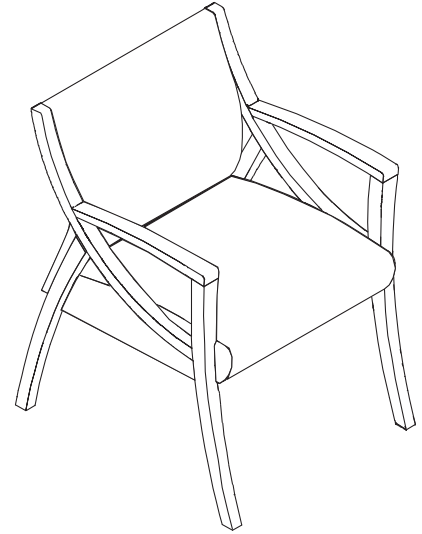

All Davari models may be ordered to meet TB133 fire code.

To order seating to meet the TB133 fire code, specify an "F" at the end of the model number (Ex: N48GFAF).

For TB133 pricing go to www.NationalOfficeFurniture.com/TB133

Please consult customer service for applicable Arc-Com, Carnegie, DesignTex, Maharam, Mayer, Momentum, Stinson, or Ultrafabrics fabric.

FABRICS

Grade 1
 Cali
 Entwine
 Melange
 Ridge
 Spark
 Vessel
 Zig Zag

Grade 2
 Bliss
 Brilliant
 Dolce
 Intuition
 Orbit
 Pixie
 Sedona
 Stencil
 Strand

Grade 3
 Silvertex

Grade 4
 Connect Four
 Echo
 Masquerade

Grade 5
 Mode

Grade 6
 Essence/Ultraleather

Grade 7
 Brisa
 Brisa Distressed
 Reef Pro
 Silica
 Tottori

FINISHES

AC	Autumn	NM	Natural
AD	Almond	PB	Portobello
BZ	Brazilwood	PC	Porcini
CI	Chai	PT	Portico
CL	Caramel	SK	Skyline
CW	Cordovan	SM	Sonoma
DW	Judicial	TF	Truffle
HN	Honey	WL	Willow
IM	Brighton	405	Designer White
KN	Kona	462	Cinder
MC	Amber	792	Sable
MH	Mocha	793	Acorn*

*Acorn is the finish complement to Clear Walnut finish



Shaded models are available through our Quick Delivery program and will be delivered within 10 days or less. Shaded models that feature the 48 icon will ship within 48 hours (48). See page 6 for additional program information.

TO ORDER, SPECIFY:

1. Model Number
2. Fabric Grade Number
3. Cover Number
4. Finish Designator

• See page 121 for Davari options
See page 124 for COM fabric yardage

ARMS

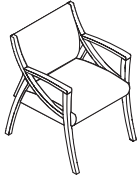

MODEL NO.

GRADE / LIST PRICE

	1	2/COM	3/COL	4	5	6	7	L7	L8
QN48GFA	\$ 1956	2016	2043	2087	2135	2216	2325		

DIMENSIONS

Width	23%	Seat Height	18	Arm Height	26	Weight	39
Depth	26½	Seat Depth	17½	Back Height	14½	Cubic Ft.	16.8
Height	32¾	Seat Width	20%	Back Width	20%		

ARMLESS

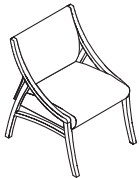

	1	2/COM	3/COL	4	5	6	7	L7	L8
QN48GFM	\$ 1855	1915	1942	1986	2034	2115	2224		

DIMENSIONS

Width	23%	Seat Height	18	Back Height	14½	Weight	38
Depth	26½	Seat Depth	17½	Back Width	20%	Cubic Ft.	16.8
Height	32¾	Seat Width	20%				

DITTO

Product Specifications	134
Fabrics and Options	135
Product Pages	136

DITTO PRODUCT SPECIFICATIONS

FRAME CONSTRUCTION

- Sled base frame legs are made of $\frac{3}{8}$ " thick steel for strength and durability
- Cross members are constructed of $1\frac{1}{2}$ " x $\frac{1}{8}$ " 15-gauge thick steel
- Legs are joined to cross member bars with metal inert gas (MIG) welds

STOOL FRAME CONSTRUCTION

- Frame legs are made of $\frac{3}{4}$ " thick steel for strength and durability
- Cross members are constructed of $1\frac{1}{2}$ " x $\frac{1}{8}$ " 15-gauge thick steel
- Legs are joined to cross member bars with metal inert gas (MIG) welds

BACK AND SEAT CONSTRUCTION

- Contoured, injection molded polypropylene seat and back
- Seats and back are attached to the frame with screws

UPHOLSTERED SEAT PAD

- Polypropylene seat panel
- $\frac{1}{2}$ " polyurethane foam

GLIDES

- Durable clear nylon glides are standard
- Glides are ganging on guest chair, stool model is non-ganging
- Clear felt glide option available for an upcharge

FINISHED

- Polished aluminum

TRANSPORT DOLLY

- $\frac{3}{4}$ " x 14-gauge tubular steel
- 3" locking casters
- Black electrostatically baked-on powder coat paint is standard
- Some assembly required

STACKING CAPABILITIES

- Plastic seat models can be stacked up to 25 high on transport dolly and 8 high on floor
- Upholstered seat models can be stacked up to 20 high on transport dolly and 6 high on floor

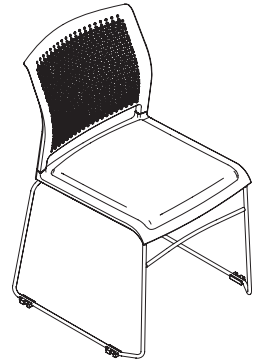
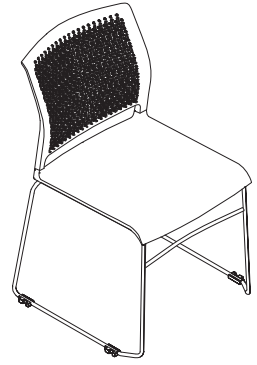

All Ditto models may be ordered to meet TB133 fire code.

FABRICS

Grade 1	Cali
	Entwine
	Melange
	Ridge
	Spark
	Vessel
	Zig Zag

Grade 2	Bliss
	Brilliant
	Dolce
	Intuition
	Orbit
	Pixie
	Sedona
	Stencil
	Strand

Grade 3	Silvertex
---------	-----------

Grade 4	Connect Four
	Echo
	Masquerade

Grade 5	Mode
---------	------

Grade 6	Essence/Ultraleather
---------	----------------------

Grade 7	Brisa
	Brisa Distressed
	Reef Pro
	Silica
	Tottori

BACK/SEAT COLORS

201	White
202	Light Grey
204	Taupe
205	Red
206	Blue
208	Black
209	Orange

GLIDES

STD	Hard (standard)
C56	Soft (add \$24 list per chair)

DITTO

DITTO



Shaded models are available through our Quick Delivery program and will be delivered within 10 days or less. Shaded models that feature the 48 icon will ship within 48 hours (48). See page 6 for additional program information.

TO ORDER, SPECIFY:

• See page 135 for Ditto options

1. Model Number
2. Back/Seat Color
3. Glides

GUEST STACKER



MODEL NO.

GRADE / LIST PRICE

QN36GM	Package of 1, Plastic	\$ 372
QN36G4M	Package of 4, Plastic	1158

DIMENSIONS

Width	22½	Seat Height	18½	Back Height	17¼	Weight (1)	27
Depth	21½	Seat Depth	17½	Back Width	17½	Cubic Ft. (1)	16.7
Height	33½	Seat Width	18			Weight (4)	69
						Cubic Ft. (4)	17.3

• Felt ganging glide option available

COUNTER HEIGHT STOOL

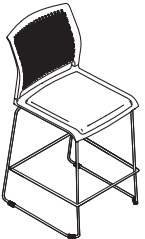

QN36CM	Package of 1, Plastic	\$ 556
QN36C2M	Package of 2, Plastic	1032

DIMENSIONS

Width	21½	Seat Height	24½	Back Height	17½	Weight (1)	29
Depth	23½	Seat Depth	17½	Back Width	17¼	Cubic Ft. (1)	14.3
Height	38¼	Seat Width	18			Weight (2)	49
						Cubic Ft. (2)	15.3

• Felt non-ganging glide option available



Shaded models are available through our Quick Delivery program and will be delivered within 10 days or less. Shaded models that feature the 48 icon will ship within 48 hours (48). See page 6 for additional program information.

TO ORDER, SPECIFY:

• See page 135 for Ditto options

1. Model Number
2. Back/Seat Color
3. Glides

BAR HEIGHT STOOL

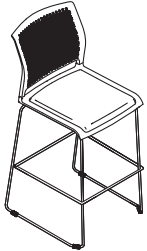
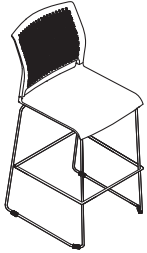

MODEL NO.

GRADE / LIST PRICE

QN36SM	Package of 1, Plastic	\$	556
QN36S2M	Package of 2, Plastic		1032

DIMENSIONS

Width	21¼	Seat Height	30¼	Back Height	17¼	Weight (1)	31
Depth	22¼	Seat Depth	17¼	Back Width	17¼	Cubic Ft. (1)	17.2
Height	45	Seat Width	18			Weight (2)	50
						Cubic Ft. (2)	19.2

• Felt non-ganging glide option available

ELOQUENCE

GUEST, TANDEM, BARIATRIC, GANGING TABLES

Product Specifications	164
Fabrics and Options	165
Product Pages	167

LOUNGE, FREESTANDING TABLES

Product Specifications	170
Fabrics and Options	171
Product Pages	173

ELOQUENCE

ELOQUENCE PRODUCT SPECIFICATIONS—GUEST, TANDEM, BARIATRIC, GANGING TABLES

FRAME CONSTRUCTION

- Constructed of beech with mortise and tenon joints on top rail and doweled joints on front and back rails
- Each joint is securely glued for maximum joint stability
- Features back legs cut from steam bent beech wood
- Non-marring nylon glides

ARMS

- Available with black protective polyurethane arm caps for added durability

SEAT CONSTRUCTION (N85SA, N85SB, N85SC, N85SAA, N85SAAA, N85SACA)

- 2" of high grade polyurethane foam covers a plywood panel with high tension strip webbing for comfort
- Corner blocks are screwed and glued in all 4 corners of the seat

SEAT CONSTRUCTION (N85SE)

- 2" of high grade polyurethane foam covers a solid seat panel
- Corner blocks are screwed and glued in all 4 corners of the seat

BACK CONSTRUCTION (ALL MODELS)

- $\frac{3}{4}$ " of high grade polyurethane foam covers the front of a contoured panel for support and comfort
- The outer (extreme) back features $\frac{1}{4}$ " of high grade polyurethane foam

CONTRASTING FABRICS

- Guest and tandem seating available with contrasting fabric

FINISH

- Features a catalyzed top coat that resists denting, peeling and reactions to chemicals
- Can be cleaned with a damp cloth
- When specifying Brighton, Natural, and Sonoma finish, variation in color is acceptable due to the nature of wood characteristics

WOOD SPECIES

- Beech

TABLES

- Laminate models feature $\frac{3}{4}$ " particle board with laminate (HPL) top and European beech façade rails and legs

STITCH-IT

- All models available with Stitch-it option, except bariatric

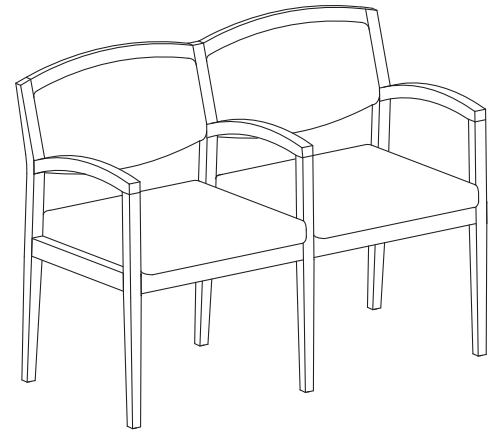

All Eloquence models may be ordered to meet TB133 fire code.

To order seating to meet the TB133 fire code, specify an "F" at the end of the model number (Ex: N85SAF).

For TB133 pricing go to www.NationalOfficeFurniture.com/TB133

Please consult customer service for applicable Arc-Com, Carnegie, Designtex, Maharam, Mayer, Momentum, Stinson, or Ultrafabrics fabric.

FABRICS

Grade 1
 Cali
 Entwine
 Melange
 Ridge
 Spark
 Vessel
 Zig Zag

Grade 2
 Bliss
 Brilliant
 Dolce
 Intuition
 Orbit
 Pixie
 Sedona
 Stencil
 Strand

Grade 3
 Silvertex

Grade 4
 Connect Four
 Echo
 Masquerade

Grade 5
 Mode

Grade 6
 Essence/Ultraleather

Grade 7
 Brisa
 Brisa Distressed
 Reef Pro
 Silica
 Tottori

FINISHES

AC	Autumn	NM	Natural
AD	Almond	PB	Portobello
BZ	Brazilwood	PC	Porcini
CI	Chai	PT	Portico
CL	Caramel	SK	Skyline
CW	Cordovan	SM	Sonoma
DW	Judicial	TF	Truffle
HN	Honey	WL	Willow
IM	Brighton	405	Designer White
KN	Kona	462	Cinder
MC	Amber	792	Sable
MH	Mocha	793	Acorn*

*Acorn is the finish complement to Clear Walnut finish



Shaded models are available through our Quick Delivery program and will be delivered within 10 days or less. Shaded models that feature the 48 icon will ship within 48 hours (48). See page 6 for additional program information.

TO ORDER, SPECIFY:

1. Model Number
2. Fabric Grade Number
3. Cover Number
4. Finish Designator

• See page 165 for Eloquence options
See page 178 for COM fabric yardage

**GUEST
HALF UPHOLSTERED BACK**



**MODEL
NO.**

GRADE / LIST PRICE

	1	2/COM	3/COL	4	5	6	7	L7	L8
QN85SA	\$ 1338	1366	1379	1400	1422	1460	1512		

DIMENSIONS

Width	22 ¹ / ₁₆	Seat Height	19 ¹ / ₂	Arm Height	27 ³ / ₈	Weight	18
Depth	22 ¹ / ₂	Seat Depth	18	Back Height	14 ² / ₂	Cubic Ft.	15.5
Height	34 ¹ / ₄	Seat Width	20 ¹ / ₄	Back Width	20 ¹ / ₄		

**GUEST
FULLY UPHOLSTERED BACK**



	1	2/COM	3/COL	4	5	6	7	L7	L8
QN85SB	\$ 1416	1455	1472	1501	1532	1584	1655		

DIMENSIONS

Width	22 ¹ / ₁₆	Seat Height	19 ¹ / ₂	Arm Height	27 ³ / ₈	Weight	18
Depth	22 ¹ / ₂	Seat Depth	18	Back Height	14 ² / ₂	Cubic Ft.	15.5
Height	34 ¹ / ₄	Seat Width	20 ¹ / ₄	Back Width	20 ¹ / ₄		

ELOQUENCE



Shaded models are available through our Quick Delivery program and will be delivered within 10 days or less. Shaded models that feature the 48 icon will ship within 48 hours (48). See page 6 for additional program information.

TO ORDER, SPECIFY:

1. Model Number
2. Fabric Grade Number
3. Cover Number
4. Finish Designator

• See page 165 for Eloquence options

See page 178 for COM fabric yardage

CHAIR GANGING BRACKET

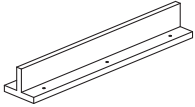

MODEL NO.

GRADE / LIST PRICE

QN85SJ	Wood	\$ 100
--------	------	--------

DIMENSIONS

Width	3 ³ / ₁₆	Weight	3
Depth	17 ¹ / ₁₆	Cubic Ft.	0.6
Height	2 ¹ / ₃₂		

- Some assembly required
- Wood bracket attaches under seat rail
- Separates adjoining chairs by 1/2"

TANDEM 2 SEAT HALF UPHOLSTERED BACK

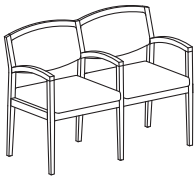

	1	2/COM	3/COL	4	5	6	7	L7	L8
QN85SAA	\$ 2449	2505	2531	2572	2617	2694	2796		

DIMENSIONS

Width	44 ¹⁷ / ₃₂	Seat Height	19 ¹ / ₃₂	Arm Height	27 ³ / ₈	Weight	36
Depth	22 ¹ / ₃₂	Seat Depth	18	Back Height	14 ²⁹ / ₃₂	Cubic Ft.	26.0
Height	34 ¹ / ₄	Seat Width	20 ¹ / ₄	Back Width	20 ¹ / ₄		

TANDEM 3 SEAT HALF UPHOLSTERED BACK

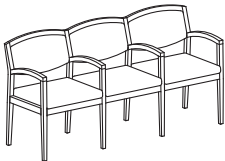

	1	2/COM	3/COL	4	5	6	7	L7	L8
QN85SAAA	\$ 3672	3760	3800	3865	3935	4055	4215		

DIMENSIONS

Width	66 ³ / ₈	Seat Height	19 ¹ / ₃₂	Arm Height	27 ³ / ₈	Weight	48
Depth	22 ¹ / ₃₂	Seat Depth	18	Back Height	14 ²⁹ / ₃₂	Cubic Ft.	37.6
Height	34 ¹ / ₄	Seat Width	20 ¹ / ₄	Back Width	20 ¹ / ₄		

ELOQUENCE

ELOQUENCE

ELOQUENCE PRODUCT SPECIFICATIONS—LOUNGE, FREESTANDING TABLES

FRAME CONSTRUCTION

- Interior frame is constructed of plywood with tenon joints that are glued and screwed for maximum joint stability
- Exterior frame is constructed of beech with mortise and tenon joints
- Each joint is securely glued for maximum joint stability
- Non-marring nylon glides

SEAT CONSTRUCTION

- 4" of high grade polyurethane foam covers a plywood panel with high tension strip webbing for comfort

BACK CONSTRUCTION

- 2" of high grade polyurethane foam which is stretched over web sheet and attached to frame

ARM CONSTRUCTION

- ¾" of high grade polyurethane foam covers both the interior and exterior upholstery panel
- Available with black protective polyurethane arm caps for added durability

CONTRASTING FABRICS

- Available with contrasting fabric locations: back, seat, and arms/outer back

FINISH

- Features a catalyzed top coat that resists denting, peeling and reactions to chemicals
- Can be cleaned with a damp cloth
- When specifying Brighton, Natural, and Sonoma finish, variation in color is acceptable due to the nature of wood characteristics

WOOD SPECIES

- Beech

TABLES

- Veneer models feature ¾" grade A, slipmatched, European beech veneer tops with European beech façade rails and legs
- Laminate models feature ¾" particle board with laminate (HPL) top and European beech façade rails and legs

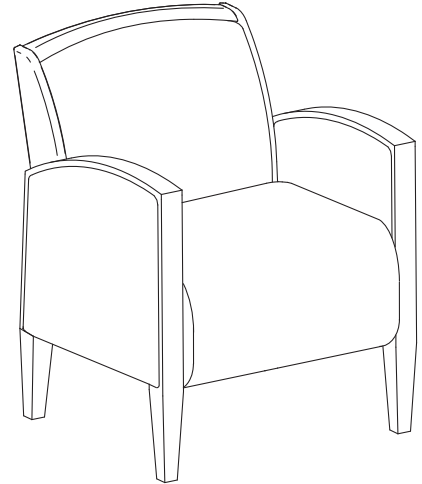

All Eloquence models may be ordered to meet TB133 fire code.

To order seating to meet the TB133 fire code, specify an "F" at the end of the model number (Ex: N85LAF).

For TB133 pricing go to www.NationalOfficeFurniture.com/TB133

Please consult customer service for applicable Arc-Com, Carnegie, Designtex, Maharam, Mayer, Momentum, Stinson, or Ultrafabrics fabric.

FABRICS

Grade 1	Cali
	Entwine
	Melange
	Ridge
	Spark
	Vessel
	Zig Zag

Grade 2	Bliss
	Brilliant
	Dolce
	Intuition
	Orbit
	Pixie
	Sedona
	Stencil
	Strand

Grade 3	Silvertex
---------	-----------

Grade 4	Connect Four
	Echo
	Masquerade

Grade 5	Mode
---------	------

Grade 6	Essence/Ultraleather
---------	----------------------

Grade 7	Brisa
	Brisa Distressed
	Reef Pro
	Silica
	Tottori

FINISHES

AC	Autumn	NM	Natural
AD	Almond	PB	Portobello
BZ	Brazilwood	PC	Porcini
CI	Chai	PT	Portico
CL	Caramel	SK	Skyline
CW	Cordovan	SM	Sonoma
DW	Judicial	TF	Truffle
HN	Honey	WL	Willow
IM	Brighton	405	Designer White
KN	Kona	462	Cinder
MC	Amber	792	Sable
MH	Mocha	793	Acorn*

*Acorn is the finish complement to Clear Walnut finish

POLYURETHANE ARM CAPS

1 SEAT LOUNGE





Shaded models are available through our Quick Delivery program and will be delivered within 10 days or less. Shaded models that feature the 48 icon will ship within 48 hours (48). See page 6 for additional program information.

TO ORDER, SPECIFY:

1. Model Number
2. Fabric Grade Number
3. Cover Number
4. Finish Designator

• See page 171 for Eloquence options

See page 178 for COM fabric yardage

1 SEAT LOUNGE



MODEL NO.

GRADE / LIST PRICE

		1	2/COM	3/COL	4	5	6	7	L7	L8
QN85LA		\$ 3157	3255	3300	3373	3451	3585	3765		
QN85LAT	Black Polyurethane Arm Caps	3337	3435	3480	3553	3631	3765	3945		

DIMENSIONS

Width	27	Seat Height	19	Arm Height	27½	Weight	79
Depth	28¾	Seat Depth	19			Cubic Ft.	20.3
Height	34	Seat Width	22				

ESSAY

Product Specifications	180
Fabrics and Options	181
Product Pages	182



ESSAY PRODUCT SPECIFICATIONS

SHELL CONSTRUCTION

- Contoured, injection molded polypropylene
- Wall friendly design

UPHOLSTERED SEAT FOAM

- $\frac{3}{8}$ " foam

4-LEG BASE

- Injection molded glass filled nylon

TRAY

- Injection molded polypropylene

TABLET ARM

- Chevron surface available in black HPL (24 $\frac{3}{4}$ " W x 12" D)
- Rectangle surface available in black HPL (23 $\frac{3}{4}$ " W x 11 $\frac{3}{4}$ " D) (student chairs only)

CUP HOLDER

- Available as an option on tablet models only
- Injection molded polypropylene
- Light assembly required

SWIVEL MECHANISM

- 360° fixed height swivel

CONTROL (TASK/STOOL OPTION)

- Swivel control
- The pneumatic gas cylinder lift allows the seat to raise and lower

CASTER

- Black, hard double wheel casters, which work on multiple surfaces, are standard
- Black, soft double wheel roll control casters, for use on hard surfaces, are available at an upcharge

GLIDES

- Soft glides are available at an upcharge

ASSEMBLY (STUDENT CHAIRS ONLY)

- Product is shipped ready-to-assemble
- 3 subassemblies join with no tools required

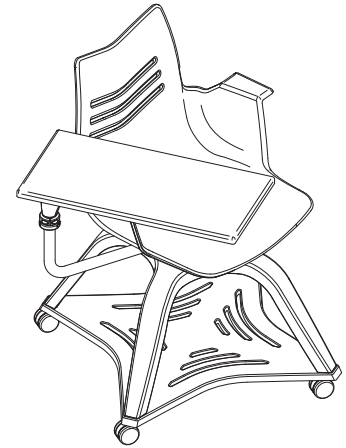

National seating meets or exceeds the ANSI/BIFMA X6.1 Educational Seating standard.

All plastic models meet TB133 fire code.

Please consult customer service for applicable Arc-Com, Carnegie, Designtex, Maharam, Mayer, Momentum, Stinson, or Ultrafabrics fabric.

FABRICS

Grade 1	Cali Entwine Melange Ridge Spark Vessel Zig Zag
---------	---

Grade 2	Bliss Brilliant Dolce Intuition Orbit Pixie Sedona Stencil Strand
---------	---

Grade 3	Silvertex
---------	-----------

Grade 4	Connect Four Echo Masquerade
---------	------------------------------------

Grade 5	Mode
---------	------

Grade 6	Essence/Ultraleather
---------	----------------------

Grade 7	Brisa Brisa Distressed Reef Pro Silica Tottori
---------	--

STUDENT CHAIR

SHELL AND TRAY COLORS

151	White
152	Light Grey
153	Dark Grey
154	Taupe
157	Navy
158	Black

**FRAME COLOR
(TABLET ARM SUPPORT
AND BASE)**

153	Dark Grey
158	Black

CUP HOLDER OPTIONS

(\$78 list upcharge)

CPB	Cup Holder, Black
X	No Cup Holder

CASTERS

C3	Hard (standard)
C29	Soft (add \$36 list per chair)

GLIDES

C27	Hard (standard)
C28	Soft (add \$41 list per chair)

TASK AND TASK STOOLS

SHELL COLORS

151	White
152	Light Grey
153	Dark Grey
154	Taupe
157	Navy
158	Black

- Task chair tablet arm support is black
- Task and task stool chair base is black
- Tablet surface is black

CUP HOLDER OPTIONS

(\$78 list upcharge)

CPB	Cup Holder, Black
X	No Cup Holder

CASTERS

C3	Hard (standard)
C29	Soft (add \$36 list per chair)

GLIDES

C27	Hard (standard)
C28	Soft (add \$41 list per chair)

TABLET

RT	Rectangle, HPL (student chair only)
CV*	Chevron, HPL

*((\$103 list upcharge)

- Tablet surface is black

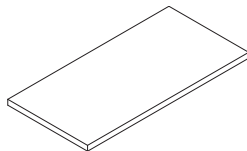

Rectangle



Chevron



Shaded models are available through our Quick Delivery program and will be delivered within 10 days or less. Shaded models that feature the 48 icon will ship within 48 hours (48). See page 6 for additional program information.

TO ORDER, SPECIFY:

1. Model Number
2. Shell Color
3. Fabric Grade / Cover Number (when applicable)
4. Tray Color
5. Frame Color
6. Tablet
7. Cup Holder (when applicable)
8. Caster or Glide

- See page 181 for Essay options
- See page 187 for COM fabric yardage

STUDENT CHAIR WITH TABLET

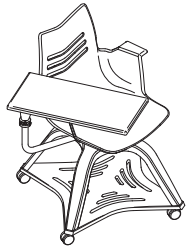

Mobile



Static

MODEL NO.

GRADE / LIST PRICE

		1	2/COM	3/COL	4	5	6	7	L7	L8
QN21AATC	Mobile	\$ 1062								
QN21AATUC	Upholstered Seat, Mobile	1241	1266	1277	1295	1315	1348	1393		
QN21AATG	Static	\$ 1062								
QN21AATUG	Upholstered Seat, Static	1241	1266	1277	1295	1315	1348	1393		

DIMENSIONS

Width	26	Seat Height	17¾	Arm Height	27	Weight	55
Depth	33	Seat Depth	17	Back Height	18¾	Upholstered Seat Model Weight	60
Height	36½	Seat Width	19½	Back Width	17	Cubic Ft.	9.5

- Overall width and depth measurements are with Chevron tablet positioned in center of chair
- Tablet surface is available in black only; shapes available in Rectangle or Chevron
- Tool-less assembly required

STUDENT CHAIR

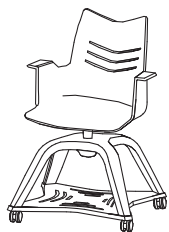

Mobile



Static

		1	2/COM	3/COL	4	5	6	7	L7	L8
QN21AAC	Mobile	\$ 785								
QN21AAUC	Upholstered Seat, Mobile	965	990	1001	1019	1039	1072	1117		
QN21AAG	Static	\$ 785								
QN21AAUG	Upholstered Seat, Static	965	990	1001	1019	1039	1072	1117		

DIMENSIONS

Width	26	Seat Height	17¾	Arm Height	27	Weight	45
Depth	24¾	Seat Depth	17	Back Height	18¾	Upholstered Seat Model Weight	50
Height	36½	Seat Width	19½	Back Width	17	Cubic Ft.	9.5

- Tool-less assembly required



Shaded models are available through our Quick Delivery program and will be delivered within 10 days or less. Shaded models that feature the 48 icon will ship within 48 hours (48). See page 6 for additional program information.

TO ORDER, SPECIFY:

1. Model Number
2. Shell Color
3. Fabric Grade / Cover Number (when applicable)
4. Tablet
5. Cup Holder (when applicable)
6. Caster or Glide

- See page 181 for Essay options
- See page 187 for COM fabric yardage

TASK CHAIR WITH TABLET



Mobile



Static

MODEL NO.

GRADE / LIST PRICE

		1	2/COM	3/COL	4	5	6	7	L7	L8
QN21BBTC	Mobile	\$ 903								
QN21BBTUC	Upholstered Seat, Mobile	1082	1107	1118	1136	1156	1189	1234		
QN21BBTG	Static	\$ 903								
QN21BBTUG	Upholstered Seat, Static	1082	1107	1118	1136	1156	1189	1234		

DIMENSIONS

Width	26	Seat Height	16¼-20¾	Arm Height	24¼-28¾	Weight	55
Depth	33	Seat Depth	17	Back Height	18¾	Upholstered Seat Model Weight	60
Height	34¼-38¾	Seat Width	19½	Back Width	17	Cubic Ft.	17.5

- Overall width and depth measurements are with Chevron tablet positioned in center of chair
- Available only with Chevron tablet surface
- Tablet surface and arm support are available in black only

TASK CHAIR



Mobile



Static

		1	2/COM	3/COL	4	5	6	7	L7	L8
QN21BBC	Mobile	\$ 627								
QN21BBUC	Upholstered Seat, Mobile	809	834	845	863	883	916	961		
QN21BBG	Static	\$ 627								
QN21BBUG	Upholstered Seat, Static	809	834	845	863	883	916	961		

DIMENSIONS

Width	26	Seat Height	16¼-20¾	Arm Height	24¼-28¾	Weight	45
Depth	24¾	Seat Depth	17	Back Height	18¾	Upholstered Seat Model Weight	50
Height	34¼-38¾	Seat Width	19½	Back Width	17	Cubic Ft.	17.5

- Base is available in black only



Shaded models are available through our Quick Delivery program and will be delivered within 10 days or less. Shaded models that feature the 48 icon will ship within 48 hours (48). See page 6 for additional program information.

TO ORDER, SPECIFY:

1. Model Number
2. Shell Color (when applicable)
3. Fabric Grade / Cover Number (when applicable)
4. Caster or Glide (when applicable)

• See page 181 for Essay options
See page 187 for COM fabric yardage

TASK STOOL

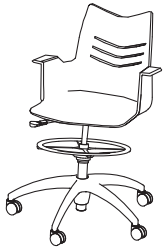

Mobile



Static

MODEL NO.

GRADE / LIST PRICE

		1	2/COM	3/COL	4	5	6	7	L7	L8
QN21CCC	Mobile	\$ 825								
QN21CCUC	Upholstered Seat, Mobile	1005	1030	1041	1059	1079	1112	1157		
QN21CCG	Static	\$ 825								
QN21CCUG	Upholstered Seat, Static	1005	1030	1041	1059	1079	1112	1157		

DIMENSIONS

Width	26	Seat Height	19½-27¼	Arm Height	27¼-35½	Weight	58
Depth	24¼	Seat Depth	17	Back Height	18¼	Upholstered Seat Model Weight	63
Height	37¼-45	Seat Width	19½	Back Width	17	Cubic Ft.	17.5

• Base is available in black only

UPHOLSTERED SEAT CUSHION



		1	2/COM	3/COL	4	5	6	7	L7	L8
QN21UPH		\$ 237	262	273	291	311	344	389		

DIMENSIONS

Width	17¼	Weight	8
Depth	16½	Cubic Ft.	1.2
Height	½		

• Field installable

CUP HOLDER



QN21CUP	Black, Package of 1	\$ 78								
---------	---------------------	-------	--	--	--	--	--	--	--	--

Weight	5
Cubic Ft.	0.5

- Option for tablet models only
- Cup holder is available in black only
- Field installable
- Light assembly required

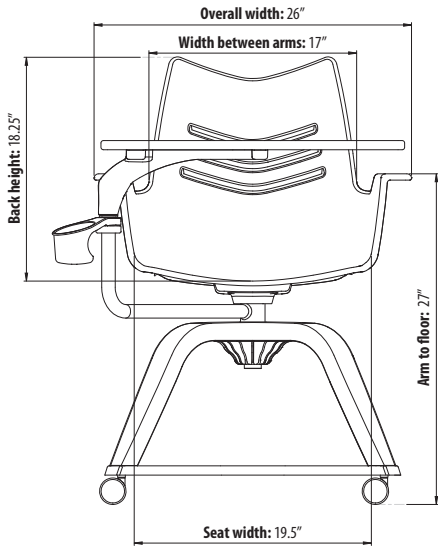

STUDENT CHAIR - FRONT VIEW

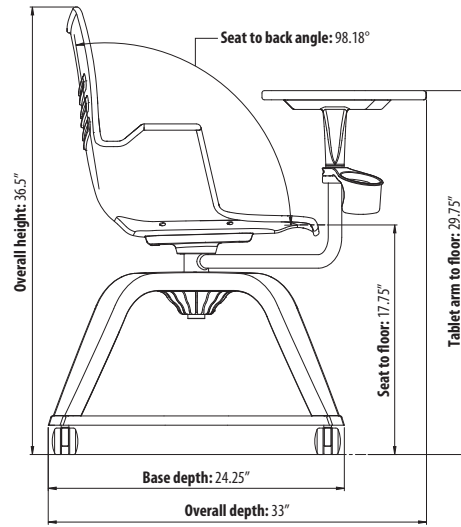

STUDENT CHAIR - SIDE VIEW

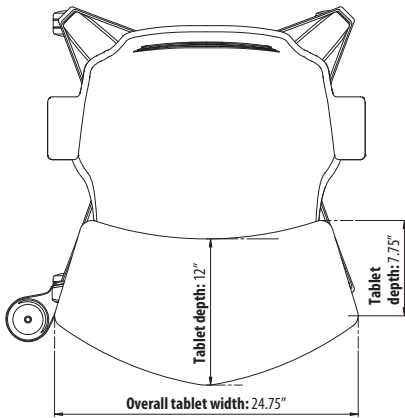

STUDENT CHAIR - TOP DOWN VIEW

*Chevron shape shown

*Rectangle shape

Overall tablet width: 23.75"

Tablet depth: 11.75"

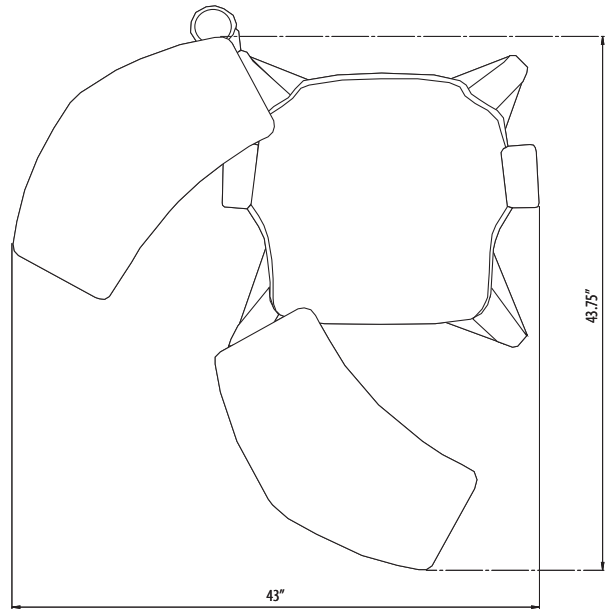

STUDENT CHAIR - TABLET SWING VIEW

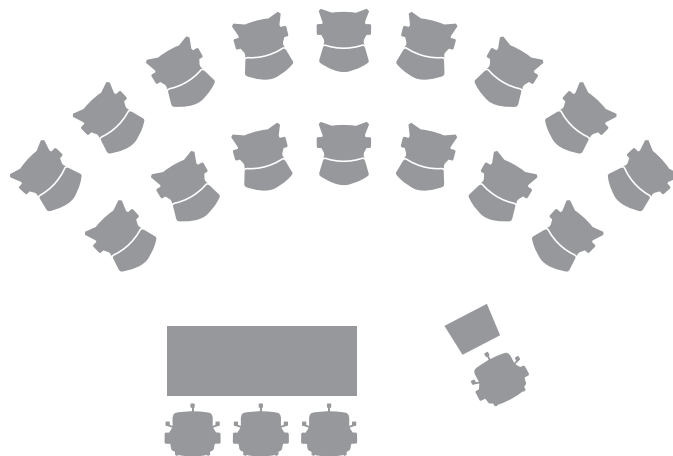
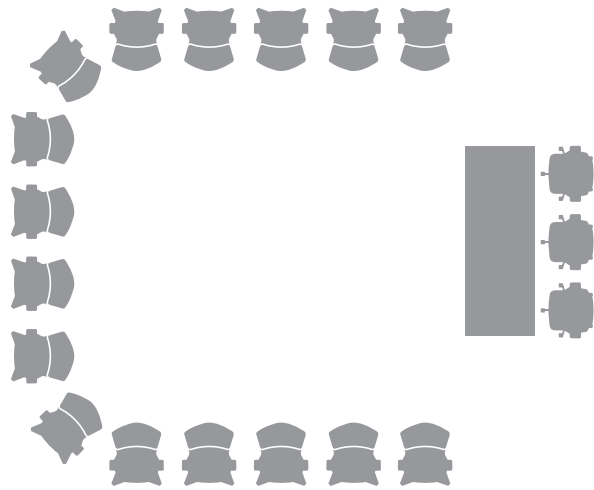
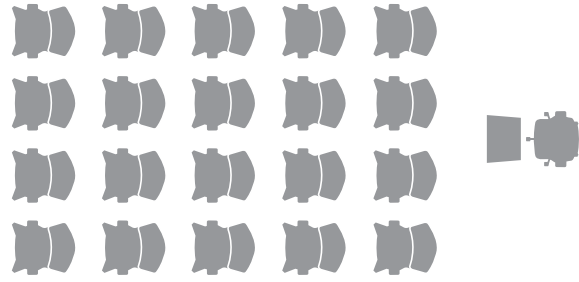

FARRAH

Product Specifications	190
Fabrics and Options	191
Product Pages	193

FARRAH

FARRAH PRODUCT SPECIFICATIONS

BACK CONSTRUCTION (CHAIR)

- 1½" of polyurethane foam covers a contoured plywood frame

SEAT CONSTRUCTION (CHAIR AND BENCH)

- 2" of polyurethane foam covers a plywood frame with high tension sheet webbing for support

ARM CONSTRUCTION (CHAIR)

- Armrest frames are wrapped with high grade polyurethane foam and slipcovered
- Arms are attached to the back and seat with mechanical fasteners

LEGS AND GLIDES

- Die cast aluminum faceted legs available in Polished Aluminum, Concrete, Cinder, Iron, Platinum Metallic, Designer White and Satin Nickel Metallic
- Durable hard black nylon height adjustable glides are standard
- Soft / non-skid adjustable glides are available for an additional upcharge

INSET PANELS (STATIC GUEST CHAIR AND BENCH)

- Formed metal sheet panels finished in corresponding leg color: Concrete, Cinder, Iron, Platinum Metallic, Designer White and Satin Nickel Metallic
- When polished legs are specified, inset panels will be Platinum Metallic

UPHOLSTERY DETAIL (CHAIR)

- Available with contrasting fabric locations; back, seat, and arms

SWIVEL MECHANISM (SWIVEL GUEST CHAIR)

- 360° swivel with auto-return

TABLE TOP

- Veneer surfaces are 1¾" slipmatched maple (Brighton, Caramel, Honey, Natural), cherry (Amber, Autumn, Cordovan, Judicial, Mocha, Truffle), quarter cut walnut (Almond, Portobello, Sable), or quarter cut oak (Sonoma) veneer and feature a standard flat wood edge or clear exposed plywood edge
- Laminate surfaces are 1¾" HPL (high pressure laminate), and feature standard 0.5mm PVC edge or clear exposed plywood edge
- Solid surfaces feature a flat rim profile
- All Veneer surfaces feature a semi-open pore matte finish

STITCH-IT

- All models available with Stitch-it option, except 2 seat bench

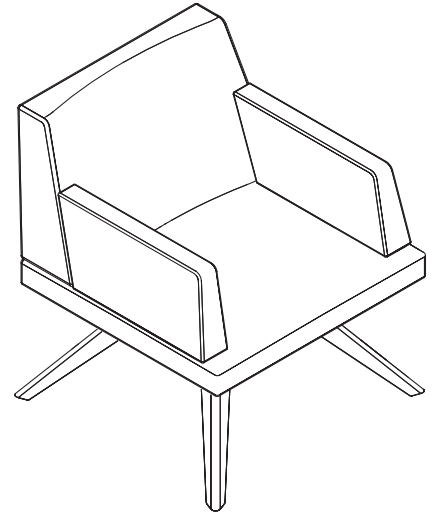

All Farrah models may be ordered to meet TB133 fire code.

To order seating to meet the TB133 fire code, specify an "F" at the end of the model number (Ex: N71M1MF).

For TB133 pricing go to www.NationalOfficeFurniture.com/TB133

Please consult customer service for applicable Arc-Com, Carnegie, Designtex, Maharam, Mayer, Momentum, Stinson, or Ultrafabrics fabric.

FABRICS

Grade 1

- Cali
- Entwine
- Melange
- Ridge
- Spark
- Vessel
- Zig Zag

Grade 2

- Bliss
- Brilliant
- Dolce
- Intuition
- Orbit
- Pixie
- Sedona
- Stencil
- Strand

Grade 3

- Silvertex

Grade 4

- Connect Four
- Echo
- Masquerade

Grade 5

- Mode

Grade 6

- Essence/Ultraleather

Grade 7

- Brisa
- Brisa Distressed
- Reef Pro
- Silica
- Tottori

FRAME COLORS

462 Cinder

497 Polished Aluminum

501 Platinum Metallic

GLIDES

STD Hard (standard)

C57 Soft (add \$41 list)



Shaded models are available through our Quick Delivery program and will be delivered within 10 days or less. Shaded models that feature the 48 icon will ship within 48 hours (48). See page 6 for additional program information.

TO ORDER, SPECIFY:

1. Model Number
2. Fabric Grade / Cover Number
3. Frame Color
4. Glides

- See page 191 for Farrah options
- See page 196 for COM fabric yardage

GUEST

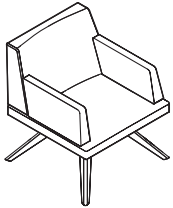

Arms

MODEL NO.

GRADE / LIST PRICE

		1	2/COM	3/COL	4	5	6	7	L7	L8
QN71M1M	Armless	\$ 2850	2910	2937	2981	3029	3110	3219		
QN71M1A	Arms	3543	3617	3650	3705	3764	3864	3999		

DIMENSIONS

Armless Width	26½	Seat Height	15%	Arm Height	24	Armless Weight	65
Single Arm Width	26½	Seat Depth	19¾	Back Height	30%	Single Arm Weight	67
Double Arm Width	26½	Arm Seat Height	20	Back Width	20	Double Arm Weight	70
Depth	27½	Armless Seat Width	26½			Armless Cubic Ft.	14.2
Height	30%					Arm Cubic Ft.	14.2

FARRAH



Shaded models are available through our Quick Delivery program and will be delivered within 10 days or less. Shaded models that feature the 48 icon will ship within 48 hours (48). See page 6 for additional program information.

TO ORDER, SPECIFY:

1. Model Number
2. Fabric Grade / Cover Number
4. Frame Color
5. Glides

- See page 191 for Farrah options
- See page 196 for COM fabric yardage

BENCH

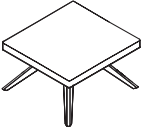

MODEL NO.

GRADE / LIST PRICE

		1	2/COM	3/COL	4	5	6	7	L7	L8
QN71D1	Single Seat Bench	\$ 2389	2428	2445	2474	2505	2557	2628		

DIMENSIONS

Width	26½		
Depth	25		
Height	15%		

Weight	63
Cubic Ft.	13.5

FIERCE

Product Specifications	198
Fabrics and Options	198
Product Pages	199

FIERCE

FIERCE PRODUCT SPECIFICATIONS

BACK AND SEAT CONSTRUCTION

- Injection molded frame

MESH

- Elastomer (Hytrel) 40% and Polyester 60%
- Cleaning code: W

ARMS

- Encased uprights are made of reinforced glass filled nylon
- Height adjustable arm adjusts in height with a push button to one of 6 positions with a 3 $\frac{3}{8}$ " range

CONTROL

- Weight balanced synchro control with seat slide
- 3 positions available in the seat slide depth adjustment range of 1 $\frac{1}{4}$ "

BASE AND CASTERS

- Black nylon 5-prong base features glass filled nylon
- Black, hard double wheel casters, which work on multiple surfaces, are standard
- Black, soft double wheel casters are available for use on hard floors

UPHOLSTERY

Black Mesh only





Shaded models are available through our Quick Delivery program and will be delivered within 10 days or less. Shaded models that feature the 48 icon will ship within 48 hours (48). See page 6 for additional program information.

TO ORDER, SPECIFY:

1. Model Number

**BLACK MESH BACK
BLACK SEAT
HEIGHT ADJUSTABLE
ARMS**



48

MODEL NO.

LIST PRICE

N76MM2SB \$ 815

DIMENSIONS

Width	26¼	Seat Height	16½-20¼	Arm Height	27¼-31	Weight	40
Depth	28	Seat Depth	16¾-18½	Back Height	22¾	Cubic Ft.	6.05
Height	37¾-41¾	Seat Width	18%	Back Width	16%		

- Specify model number only
- Ships KD, tool included

FRINGE

LOUNGE

Product Specifications	202
Fabrics and Options	203
Product Pages	207

FRINGE LOUNGE PRODUCT SPECIFICATIONS

FRAME CONSTRUCTION

- Interior frame is constructed of oriented strand board with tenon joints that are glued and screwed for maximum joint stability
- Each joint is securely glued for maximum stability

SEAT CONSTRUCTION

- Lounge chairs feature 5½" of high grade polyurethane foam covering an oriented strand board seat panel
- Club chair features 7½" of high grade polyurethane foam covering an oriented strand board seat panel

BACK CONSTRUCTION

- Lounge chairs feature 1½" of high grade custom shaped polyurethane foam stretched over web sheet and attached to frame
- Club chair features 2¼" of high grade custom shaped polyurethane foam stretched over web sheet and attached to frame

ARM REST

- Lounge chairs feature oriented strand board constructed arm frame covered with ¾" high grade polyurethane foam on arm surface and ¾" on the sides
- Club chair features oriented strand board constructed arm frame covered with 2" high grade polyurethane foam on arm surface and ¾" on the sides

TABLET ARMS

- ¾" thick laminate with MDF core or ¾" thick plywood with veneer surface
- Attached with ¼" steel base plate with screws that mounts over a ¾" insert rod and fits into structure of arm
- Allows for 360° swivel and writing surface of 17" W x 12" D
- Tablet height is 28½" from floor to top of tablet surface

LEGS AND GLIDES

- Die-cast aluminum legs available in polished or powder coated Concrete, Cinder, Iron, Platinum Metallic, or Satin Nickel Metallic
- Wood legs finished with catalyzed top coat which resists denting, peeling and reactions to chemicals
- Can be cleaned with a damp cloth
- When specifying Brighton, Natural, and Sonoma finish, variation in color is acceptable due to the nature of wood characteristics
- Features a black 1" adjustable leveling glide
- Soft glides are available for an additional upcharge
- Black LPL plinth base; available on booth models only

CLUB CHAIR BASE AND GLIDES

- Die-cast aluminum 5-prong base available in polished or powder coated Cinder, Platinum Metallic, or Satin Nickel Metallic
- Non-marring nylon glides

CLUB CHAIR CONTROL

- Features 360° swivel with auto-return, static model only

UPHOLSTERY DETAIL

- Contrasting fabric available on all models, except benches and armless club chair

POWER GROMMET

- Features 2 electrical receptacles and 2 power USB ports
- Die-cast zinc in black or silver powder coat
- 9 foot, 15 Amp cord
- UL Listed

UPHOLSTERED DIVIDER PANELS

- Constructed with an oriented strand board frame covered with ¾" high grade polyurethane foam on top and ¾" on the sides
- Upholstered divider panels are able to be attached on either side of a lounge, or in between ganged lounge units within a configuration
- If attaching to an armed unit, arm must be removed before mounting divider panel
- Compatible on N93 models
- Compatible with one, two and three seat lounge, with the exception of bistro and booth models

LAMINATE AND VENEER DIVIDER AND BACK PRIVACY PANELS

- ¾" edge banded HPL or Veneer
- Veneer features a semi-open pore matte sheen
- Attached with silver visible fasteners
- Laminate and Veneer Divider panels are able to be attached on either side of a lounge, or in between lounge units within a configuration
- Divider panels can be attached to an armless unit, or attached to an arm of any height, with the exception of tablet arms
- Divider panels and back panels are compatible on both N92 and N93 one, two and three seat lounge models, and single-sided booths
- Divider panels are compatible with bistro models, corners, curves, wedges, and coves
- When retrofitting a back panel onto a bistro model, the bistro table must be removed for the life of the back panel

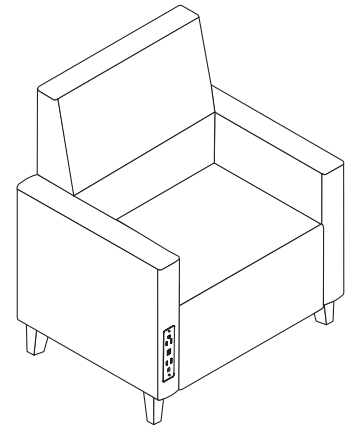
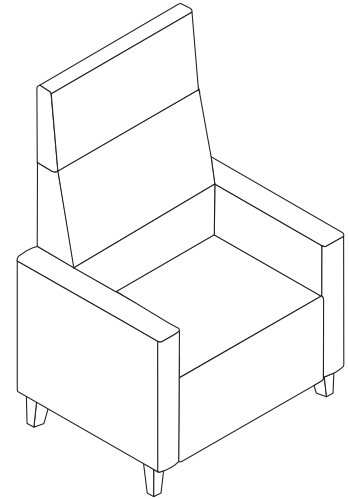

FABRICS

Grade 1	Cali Entwine Melange Ridge Spark Vessel Zig Zag
---------	---

Grade 2	Bliss Brilliant Dolce Intuition Orbit Pixie Sedona Stencil Strand
---------	---

Grade 3	Silvertex
---------	-----------

Grade 4	Connect Four Echo Masquerade
---------	------------------------------------

Grade 5	Mode
---------	------

Grade 6	Essence/Ultraleather
---------	----------------------

Grade 7	Brisa Brisa Distressed Reef Pro Silica Tottori
---------	--

LEG/BASE COLORS

METAL

462	Cinder
497	Polished Aluminum
501	Platinum Metallic

GLIDES

STD	Standard
C10	Soft (add \$41 list)

FRINGE



Shaded models are available through our Quick Delivery program and will be delivered within 10 days or less. Shaded models that feature the 48 icon will ship within 48 hours (48). See page 6 for additional program information.

TO ORDER, SPECIFY:

1. Model Number
2. Fabric Grade / Cover Number
3. Tablet Finish (when applicable)
4. Base Color

• See page 203 for Fringe options

See pages 265-279 for COM fabric yardage

CLUB CHAIR

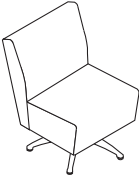

Armless Static

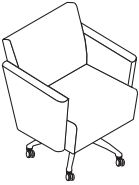

Arms, Mobile

MODEL NO.

GRADE / LIST PRICE

		1	2/COM	3/COL	4	5	6	7	L7	L8
QN93CSM	Armless	\$ 2316	2393	2428	2485	2547	2653	2793		
QN93CSMC	Armless, Mobile	2316	2393	2428	2485	2547	2653	2793		
QN93CSA	Arms	3021	3140	3194	3283	3378	3541	3759		
QN93CSAC	Arms, Mobile	3021	3140	3194	3283	3378	3541	3759		

DIMENSIONS

Width	26¼	Seat Height	18½	Arm Height	26¼	Weight	59
Width with Arms	30½	Seat Depth	19	Back Height	18	Weight with Tablet	81
Depth	28	Seat Width	23½	Back Width	23½	Weight with Tablet and 1 Arm	71
Height	34¼					Weight with Tablet and 2 Arms	93
						Cubic Ft.	18.6
						Cubic Ft. with Tablet	20.0
						Cubic Ft. with Arms	21.4

• Static models feature 360° swivel with auto-return

FRINGE

FUEL

Product Specifications	282
Fabrics and Options	283
Product Pages	284

FUEL PRODUCT SPECIFICATIONS**SEAT CONSTRUCTION**

- 2½" of high grade polyurethane foam covers a solid contoured molded plywood seat panel for support and comfort

BACK CONSTRUCTION

- Injection molded polypropylene outer shell
- Blow molded polyethylene inner back shell designed with deep ribbing to provide extra support
- Backs feature 2½" of custom molded, controlled density polyurethane foam for consistency and good contoured support on all models
- Large and tall models feature solid molded plywood panels

BACK REST

- Back height can be adjusted by simply lifting up on the back
- The range of adjustment is approximately 2"

ARMS

- Loop arms have encased high strength steel uprights made of polyurethane

CONTROL MECHANISM—INTENSIVE USE

- Synchronous control allows the back and seat to move in a synchronized 2.3:1 ratio motion
- Free float feature allows the chair to tilt freely
- A side activated telescoping tension adjustment handle provides a comfortable way to adjust back tension to meet individual needs
- The back angle can be locked in 1 of 5 positions
- Standard pneumatic gas cylinder lift allows seat to raise and lower 4¼" and provides spring action for added comfort

CONTROL MECHANISM—LARGE AND TALL MODELS

- Synchronous control allows the back and seat to move in a synchronized 2:1 ratio motion
- Free float feature allows the chair to tilt freely or be locked in the neutral position
- Standard pneumatic gas cylinder lift allows seat to raise and lower 4¼" and provides spring action for added comfort

BASE AND CASTERS

- Intensive use - Black, 5-prong fiberglass reinforced nylon base ensures long life
- Large and Tall - Feature a black, 27" 5-prong aluminum base tested using 4500 lbs. of force
- Hard, double wheel casters, which work on multiple surfaces, are standard

PERFORMANCE STANDARDS

- Intensive use models meet the Federal Intensive Usage Standard FED-STD 834
- Large and tall models meet BIFMA X5.11 Large Occupant Standard

QUICK DELIVERY PROGRAM

- All Fuel models available on Quick Delivery, including TB133



All Fuel models may be ordered to meet TB133 fire code.

To order seating to meet the TB133 fire code, specify an "F" at the end of the model number (Ex: N35MACF).

For TB133 pricing go to www.NationalOfficeFurniture.com/TB133

Please consult customer service for applicable Arc-Com, Carnegie, DesignTex, Maharam, Mayer, Momentum, Stinson, or Ultrafabrics fabric.

FABRICS

Grade 1
 Cali**
 Entwine
 Melange
 Ridge**
 Spark
 Vessel**
 Zig Zag

Grade 2
 Bliss**
 Brilliant**
 Dolce
 Intuition
 Orbit
 Pixie**
 Sedona**
 Stencil
 Strand*

Grade 3
 Silvertex**

Grade 4
 Connect Four**
 Echo**
 Masquerade**

Grade 5
 Mode**

Grade 6
 Essence/Ultraleather**

Grade 7
 Brisa**
 Brisa Distressed**
 Reef Pro**
 Silica**
 Tottori**

*Strand restricted on upholstered back models

**These fabrics meet the FED-STD 834 requirements

FINISHES

Standard Black



Shaded models are available through our Quick Delivery program and will be delivered within 10 days or less. Shaded models that feature the 48 icon will ship within 48 hours (48). See page 6 for additional program information.

TO ORDER, SPECIFY:

1. Model Number
2. Pack
3. Fabric Grade Number
4. Cover Number
5. Casters

• See page 283 for Fuel options

See page 286 for COM fabric yardage

**LARGE AND TALL
ARMLESS
SYNCHRONOUS
TILT CONTROL**



MODEL NO.

GRADE / LIST PRICE

		1	2/COM	3/COL	4	5	6	7	L7	L8
QN35MAC	Upholstered Back	\$ 2464	2555	2597	2664	2737	2862	3028		

DIMENSIONS

Width	31¼	Seat Height	18-22¼	Back Height	24-26¼	Weight	69
Depth	27½	Seat Width	24¼	Back Width	20¼	Cubic Ft.	25.5
Height	39½-47¼	Seat Depth	18				

- Meets BIFMA X5.11 Large Occupant Standard
- Ships fully assembled

**LARGE AND TALL
STATIC LOOP ARMS
SYNCHRONOUS
TILT CONTROL**



		1	2/COM	3/COL	4	5	6	7	L7	L8
QN35MBC	Upholstered Back	\$ 2750	2841	2883	2950	3023	3148	3314		

DIMENSIONS

Width	31¼	Arm Height	10	Seat Depth	18	Weight	70
Depth	27½	Arm Width	23¼	Back Height	24-26¼	Cubic Ft.	25.5
Height	39½-47¼	Seat Height	18-22¼	Back Width	20¼		
		Seat Width	24¼				

- Meets BIFMA X5.11 Large Occupant Standard
- Ships fully assembled



Shaded models are available through our Quick Delivery program and will be delivered within 10 days or less. Shaded models that feature the 48 icon will ship within 48 hours (48). See page 6 for additional program information.

TO ORDER, SPECIFY:

1. Model Number
2. Pack
3. Fabric Grade Number
4. Cover Number
5. Casters

- See page 283 for Fuel options
- See page 286 for COM fabric yardage

**INTENSIVE USE
ARMLESS
SYNCHRONOUS**



MODEL NO.	GRADE / LIST PRICE										
		1	2/COM	3/COL	4	5	6	7	L7	L8	
QN35JAC	Plastic Back	\$ 1803	1842	1859	1888	1919	1971	2042			

DIMENSIONS

Width	27½	Seat Height	16½-21	Back Height	23¼-25½	Weight	56
Depth	25½	Seat Width	20½	Back Width	18	FA Cubic Ft.	18.3
Height	38¼-45¼	Seat Depth	17¼			KD Cubic Ft.	13.3

- Pack option is not available on Quick Delivery models

**INTENSIVE USE
STATIC LOOP ARMS
SYNCHRONOUS**



MODEL NO.	GRADE / LIST PRICE										
		1	2/COM	3/COL	4	5	6	7	L7	L8	
QN35JCC	Plastic Back	\$ 2087	2126	2143	2172	2203	2255	2326			

DIMENSIONS

Width	27½	Arm Height	10	Seat Depth	17¼	Weight	58
Depth	25½	Arm Width	19½	Back Height	23¼-25½	FA Cubic Ft.	18.3
Height	38¼-45¼	Seat Height	16½-21	Back Width	18	KD Cubic Ft.	13.3
		Seat Width	20½				

- Pack option is not available on Quick Delivery models

TYPE OF TEST	FEDERAL INTENSIVE USAGE TESTING REQUIREMENTS FOR FED-STD 834	ANSI/BIFMA ACCEPTANCE
Cyclic Back and Back Tilt Mechanism Fatigue Test	1,000,000 Cycles Minimum	120,000 Cycles
Cyclic Vertical Load Test on 1 Arm	100 lbs. to 250 lbs. in 50 lb. Increments 25,000 Cycles at Each Load Level	200 lbs. 1 Time Function Load 300 lbs. 1 Time Proof Load 2,500 lbs. 1 Time Proof Load (Base Only)
Cyclic Vertical Load Test on Seats, Bases and Casters	200 lbs. to 1,300 lbs. in 50 lb. Increments 25,000 Cycles at Each Load Level	3,000 lbs. 6" 1 Drop 2,500 lbs. 1 Load (Base Only)
Cyclic Side Thrust Load Test on Arms	50 lbs. to 200 lbs. in 50 lb. Increments 25,000 Cycles at Each Load Level	100 lbs. 1 Time Function Load 150 lbs. 1 Time Proof Load
Cyclic Pneumatic Seat Height Adjustment Test	250 lbs. Cyclic Seat Load Cycle Pneumatic Unit 125,000 Full Cycles	No Comparable Test Requirement
Caster/Chair Base Durability Test	36,000 Cycles 5 lbs. Retention After Cycling	36,000 Cycles 5 lbs. Retention Minimum After Cycling

GRIN

Product Specifications	288
Fabrics and Options	289
Product Pages	291

GRIN PRODUCT SPECIFICATIONS

SEAT AND BACK CONSTRUCTION

- Lounge - 1¼" of high grade polyurethane foam covers ½" molded plywood shell
- Guest and Stools - ¾" of high grade polyurethane foam covers ½" molded plywood shell

CONTROL MECHANISM—LOUNGE

- Polished aluminum control mechanism and cylinder
- Static model features 360° swivel with auto-return
- Mobile model features 360° swivel

BASE, CASTERS AND GLIDES

4-Prong High Profile Polished Aluminum Base

- Silver polyethylene glides are standard
- Felt pad glides are available for an additional upcharge

4-Prong Low Profile Polished Aluminum Base

- Silver polyethylene glides are standard
- Felt pad glides are available for an additional upcharge

4-Prong Low Profile Mobile Polished Aluminum Base

- Black, hard double wheel casters, which work on multiple surfaces, are standard
- Soft casters are available for an additional upcharge

4-Prong High Profile Wood Base

- Maple
- Non-marring nylon glides are standard and work on all floors

Sled Base—Lounge

- 2½" welded, tubular steel in matte black or polished
- Black polyethylene glides are standard and work on all floors

Sled Base—Guest and Stools

- ½" formed and welded, steel rod in matte black or polished
- Clear polyethylene glides are standard
- Felt glide option available for an upcharge

4-Leg Wood Frame

- Maple
- ½" tubular steel footrest in matte black or polished
- Non-marring nylon glides are standard and work on all floors

UPHOLSTERY DETAIL

- Contrasting fabric available on all models
- Stitch options are available
- Due to stitch detail and dimensional design of the back and seat, horizontal stripes and large patterns are not recommended, as they will appear distorted or wavy across the front back and seat
- Due to the inherent characteristics of upholstery materials, loose comfort wrinkles may be present or appear over time

FINISH

- Features a catalyzed top coat that resists denting, peeling, and reactions to chemicals
- Can be cleaned with a damp cloth
- When specifying Brighton, Natural, and Sonoma finish, variation in color is acceptable due to the nature of wood characteristics

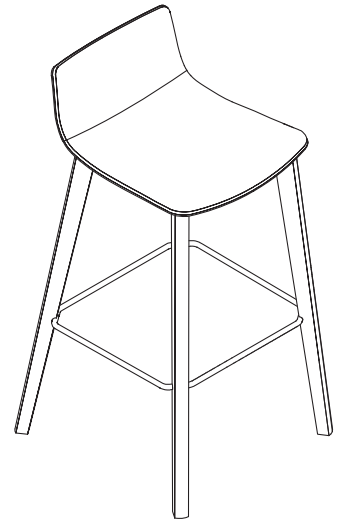
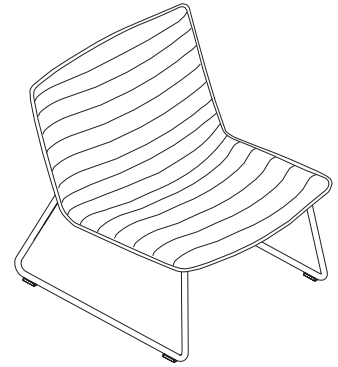

FABRICS

Grade 1
Cali
Entwine
Melange
Ridge
Spark
Vessel
Zig Zag

Grade 2
Bliss
Brilliant
Dolce
Intuition
Orbit
Sedona
Stancil
Strand

Grade 3
Silvertex

Grade 4
Connect Four
Echo
Masquerade

Grade 5
Mode

Grade 6
Essence/Ultraleather

Grade 7
Brisa
Brisa Distressed
Reef Pro
Silica
Tottori

LOUNGE CASTERS

4-PRONG MOBILE LOW PROFILE BASE

C3 Hard (standard)
C4 Soft (add \$36 list)

LOUNGE & OTTOMAN GLIDES

4-PRONG HIGH PROFILE POLISHED ALUMINUM BASE

STD Hard (standard)
C58 Soft (add \$41 list)

GUEST & STOOL GLIDES

WOOD BASE

STD Hard (standard)

SLED BASE

STD Hard (standard)
C73 Soft (add \$24 list)

SLED BASE FRAME COLORS

BK Black
497 Polished

FINISHES

AC	Autumn	NM	Natural
AD	Almond	PB	Portobello
BZ	Brazilwood	PC	Porcini
CI	Chai	PT	Portico
CL	Caramel	SK	Skyline
CW	Cordovan	SM	Sonoma
DW	Judicial	TF	Truffle
HN	Honey	WL	Willow
IM	Brighton	405	Designer White
KN	Kona	462	Cinder
MC	Amber	792	Sable
MH	Mocha	793	Acorn*

*Acorn is the finish complement to Clear Walnut finish

WOOD LEG FOOT REST COLORS

BK Black
497 Polished

STITCH OPTION

NO STITCH

HRZ_150 (1½" WIDTH)

HRZ1_250 (2½" WIDTH)

HRZ1_600 (6" WIDTH)

LOUNGE



GUEST



STOOL





Shaded models are available through our Quick Delivery program and will be delivered within 10 days or less. Shaded models that feature the 48 icon will ship within 48 hours (48). See page 6 for additional program information.

TO ORDER, SPECIFY:

1. Model Number
2. Fabric Grade / Cover Number
3. Stitch Option (when applicable)
4. Finish (when applicable)
5. Casters/Glides (when applicable)

- See page 289 for Grin options
- See page 295 for COM fabric yardage

**LOUNGE
SLED BASE**

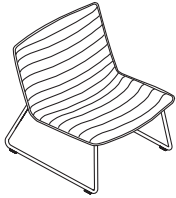

**MODEL
NO.**

GRADE / LIST PRICE

		1	2/COM	3/COL	4	5	6	7	L7	L8
QN49GMD1		\$ 1794	1871	1906	1963	2025	2131	2271		
QN49GMND1	No Stitch, No Piping	1757	1831	1864	1919	1978	2078	2213		

DIMENSIONS

Width	27	Seat Height	13¾	Back Height	19¾	Weight	35
Depth	31	Seat Depth	20½	Back Width	27	Cubic Ft.	22.9
Height	30	Seat Width	27				

- Due to stitch detail and dimensional design of the back and seat, horizontal stripes and large patterns are not recommended, as they will appear distorted or wavy across the back and seat
- Due to the inherent characteristics of certain upholstery materials, loose comfort wrinkles may be present or appear over time, especially with non-stretch vinyls and upholsteries
- Sled base model seat height is 1¾" -2" lower than the swivel base model

**LOUNGE
4-PRONG
LOW PROFILE
POLISHED ALUMINUM
BASE WITH AUTO RETURN**



Static

		1	2/COM	3/COL	4	5	6	7	L7	L8
QN49GMS1		\$ 1794	1871	1906	1963	2025	2131	2271		
QN49GMNS1	No Stitch, No Piping	1757	1831	1864	1919	1978	2078	2213		

DIMENSIONS

Width	27	Seat Height	15½	Back Height	19¾	Weight	34
Depth	28	Seat Depth	20½	Back Width	27	Cubic Ft.	22.9
Height	31¾	Seat Width	27				

- Due to stitch detail and dimensional design of the back and seat, horizontal stripes and large patterns are not recommended, as they will appear distorted or wavy across the back and seat
- Due to the inherent characteristics of certain upholstery materials, loose comfort wrinkles may be present or appear over time, especially with non-stretch vinyls and upholsteries
- Swivel base model seat height is 1¾" -2" higher than the sled base model



Shaded models are available through our Quick Delivery program and will be delivered within 10 days or less. Shaded models that feature the 48 icon will ship within 48 hours (48). See page 6 for additional program information.

TO ORDER, SPECIFY:

1. Model Number
2. Fabric Grade / Cover Number
3. Stitch Option (when applicable)
4. Finish (when applicable)
5. Casters/Glides (when applicable)

- See page 289 for Grin options
- See page 295 for COM fabric yardage

**LOUNGE
4-PRONG
LOW PROFILE
MOBILE BASE**



Mobile

MODEL NO.

GRADE / LIST PRICE

		1	2/COM	3/COL	4	5	6	7	L7	L8
QN49GMSC1	Mobile	\$ 1794	1871	1906	1963	2025	2131	2271		
QN49GMNSC1	No Stitch, No Piping	1757	1831	1864	1919	1978	2078	2213		

DIMENSIONS

Width	28	Seat Height	15	Back Height	20¼	Weight	34
Depth	28½	Seat Depth	20½	Back Width	28	Cubic Ft.	22.9
Height	30¼	Seat Width	28				

- Due to stitch detail and dimensional design of the back and seat, horizontal stripes and large patterns are not recommended, as they will appear distorted or wavy across the back and seat
- Due to the inherent characteristics of upholstery materials, loose comfort wrinkles may be present or appear over time



Shaded models are available through our Quick Delivery program and will be delivered within 10 days or less. Shaded models that feature the 48 icon will ship within 48 hours (48). See page 6 for additional program information.

TO ORDER, SPECIFY:

1. Model Number
2. Fabric Grade / Cover Number
3. Stitch Option (when applicable)
4. Paint (when applicable)
5. Finish (when applicable)
6. Glides (when applicable)

• See page 289 for Grin options
See page 295 for COM fabric yardage

GUEST



Sled



Wood Leg

MODEL NO.

GRADE / LIST PRICE

		1	2/COM	3/COL	4	5	6	7	L7	L8
QN49GUM	Metal	\$ 1035	1084	1106	1143	1182	1249	1339		
QN49GUNM	Metal, No Stitch	1000	1039	1056	1085	1116	1168	1239		
QN49GUW	Wood	1221	1270	1292	1329	1368	1435	1525		
QN49GUNW	Wood, No Stitch	1186	1225	1242	1271	1302	1354	1425		

DIMENSIONS

Width	19¾	Seat Height	18¾	Back Height	17	Weight (M)	25
Depth	22½	Seat Depth	17	Back Width	16¾	Weight (W)	24
Height	32¾	Seat Width	18¾			Cubic Ft	11.5

• Available with 1½" and 2½" stitch options, unless No Stitch model is specified



Shaded models are available through our Quick Delivery program and will be delivered within 10 days or less. Shaded models that feature the 48 icon will ship within 48 hours (48). See page 6 for additional program information.

TO ORDER, SPECIFY:

1. Model Number
2. Fabric Grade / Cover Number
3. Stitch Option (when applicable)
4. Paint (when applicable)
5. Finish (when applicable)
6. Glides (when applicable)

• See page 289 for Grin options

See page 295 for COM fabric yardage

COUNTER

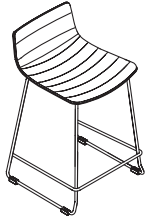

Sled



Wood Leg

MODEL NO.

GRADE / LIST PRICE

		1	2/COM	3/COL	4	5	6	7	L7	L8
QN49CUM	Metal	\$ 1107	1139	1153	1176	1202	1245	1302		
QN49CUNM	Metal, No Stitch	1070	1095	1106	1124	1144	1177	1222		
QN49CUW	Wood	1365	1397	1411	1434	1460	1503	1560		
QN49CUNW	Wood, No Stitch	1329	1354	1365	1383	1403	1436	1481		

DIMENSIONS

Width	18½	Seat Height	23¾	Back Height	7¼	Weight (M)	26
Depth	18¾	Seat Depth	15¾	Back Width	14¾	Weight (W)	24
Height	30¼	Seat Width	18¾			Cubic Ft	11.5

• Available with 1½" and 2½" stitch options, unless No Stitch model is specified

BAR



Sled

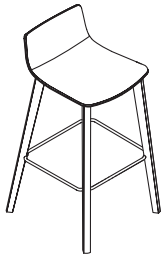

Wood Leg

		1	2/COM	3/COL	4	5	6	7	L7	L8
QN49BUM	Metal	\$ 1142	1174	1188	1211	1237	1280	1337		
QN49BUNM	Metal, No Stitch	1107	1132	1143	1161	1181	1214	1259		
QN49BUW	Wood	1401	1433	1447	1470	1496	1539	1596		
QN49BUNW	Wood, No Stitch	1365	1390	1401	1419	1439	1472	1517		

DIMENSIONS

Width	19¾	Seat Height	30½	Back Height	7¼	Weight (M)	29
Depth	18¾	Seat Depth	15¾	Back Width	14¾	Weight (W)	26
Height	36½	Seat Width	15¾			Cubic Ft	12.6

• Available with 1½" and 2½" stitch options, unless No Stitch model is specified

JEWEL

Product Specifications	316
Product Pages	317

JEWEL

JEWEL PRODUCT SPECIFICATIONS

FRAME CONSTRUCTION

- $\frac{29}{32}$ " hot rolled, welded, polished, tubular steel

SEAT AND BACK

- $\frac{7}{16}$ " molded plywood cross banded for strength
- Custom molded and contoured for comfort and support

ARM CAPS

- $1\frac{1}{8}$ " thick solid bentwood, finished to match the shell

GLIDES

- Black nylon glides are standard

FINISH

- Brighton, Pecan, Grey, White, and Black feature a catalyzed top coat
- White is enamel paint
- When specifying Brighton, Pecan, and Grey finish, variation in color is acceptable due to the nature of wood characteristics

WOOD

- Beech

STACKABILITY

- Side chair and stool bumpers are each stackable up to 4 high
- Rubber stack bumpers are standard

GANGING BRACKETS

- Sold in package of 5 pairs
- 1 pair is required to gang 2 chairs, 2 pairs will gang 3 chairs
- Ganging brackets snap onto the legs
- Armless models or alternating armless and arm chair may be connected
- 2 arm chair models cannot be ganged side by side

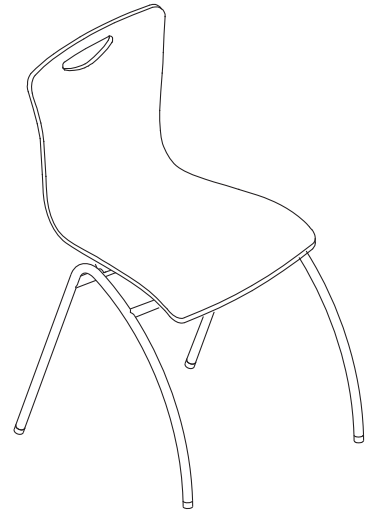

All Jewel models meet TB133 fire code.



Shaded models are available through our Quick Delivery program and will be delivered within 10 days or less. Shaded models that feature the 48 icon will ship within 48 hours (48). See page 6 for additional program information.

TO ORDER, SPECIFY:

1. Model Number

ARMLESS



MODEL NO.

LIST PRICE

N44GM1WPE	Pecan	\$	672
N44GM1WIM	Brighton		672
N44GM1WBL	Black		672
N44GM1WGR	Grey		672
N44GM1WWH	White		672

DIMENSIONS

Width	19¾	Seat Height	18¾	Back Height	17¾	Weight	15
Depth	23¾	Seat Depth	17¾	Back Width	17¾	Cubic Ft.	4.5
Height	31¾	Seat Width	18				

ARMS



N44GA1WPE	Pecan	\$	828
N44GA1WIM	Brighton		828
N44GA1WBL	Black		828
N44GA1WGR	Grey		828
N44GA1WWH	White		828

DIMENSIONS

Width	19¾	Seat Height	18¾	Arm Height	26¾	Weight	18
Depth	23¾	Seat Depth	17¾	Back Height	17¾	Cubic Ft.	4.5
Height	31¾	Seat Width	18	Back Width	17¾		

ARMLESS STOOL

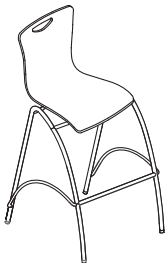

N44SM2WPE	Pecan, Package of 2	\$	2019
N44SM2WIM	Brighton, Package of 2		2019
N44SM2WBL	Black, Package of 2		2019
N44SM2WGR	Grey, Package of 2		2019
N44SM2WWH	White, Package of 2		2019

DIMENSIONS

Width	21½	Seat Height	29¾	Back Height	17¾	Weight	24.5
Depth	24¾	Seat Depth	17¾	Back Width	17¾	Cubic Ft.	9.6
Height	43¾	Seat Width	18				

GANGING BRACKET



N44GB	Package of 5 pairs	\$	78
-------	--------------------	----	----

DIMENSIONS

Width	4½			Weight	4
Depth	1			Cubic Ft.	0.5
Height	1½				

- 1 pair is required to gang 2 chairs, 2 pairs will gang 3 chairs
- Armless models or alternating armless and arm chair may be ganged
- 2 arm chairs cannot be ganged together

JIMINY

Product Specifications	320
Fabrics and Options	321
Product Pages	323

JIMINY PRODUCT SPECIFICATIONS

FRAME CONSTRUCTION

- Legs are made of 1¼" x ⅝" thick steel for strength and durability
- Cross members are constructed of ⅝" x 14-gauge thick steel
- Leg is joined to cross member bar with metal inert gas (MIG) welds
- Flexible back mechanism and frame connectors are die-cast polished aluminum

SEAT CONSTRUCTION

- 1⅝" of high grade polyurethane foam
- Contoured, injection molded nylon seat panel with an inner polyethylene seat support

BACK CONSTRUCTION

- Contoured, injection mold glass filled nylon
- Flexible back mechanism allows 9° of recline

MESH

- 64% polyelastomeric, 36% polyester
- Cleaning code W
- 100,000+ double rubs

BACK UPHOLSTERY

- Two-piece plastic back with 1" foam thickness

ARMREST

- ABS plastic arm cap attached to a glass filled nylon arm support
- Arms adjust 2" forward to backward

GLIDES

- Durable hard black nylon glides
- Back static legs feature small glide rollers to allow for ease of mobility when nesting
- Soft glides are available at an upcharge
- Soft glides do not feature small glide roller on back legs

CASTERS

- 44 mm black double wheel, which work on multiple surfaces
- Soft, double wheel casters, for use on hard floors, are available at an upcharge

FINISH

- Cinder and Platinum Metallic frames are finished with electrostatically baked-on powder coat paint

NESTED DIMENSIONS

- Nested depth of 2 chairs is 31"; add 10" for each additional nested chair

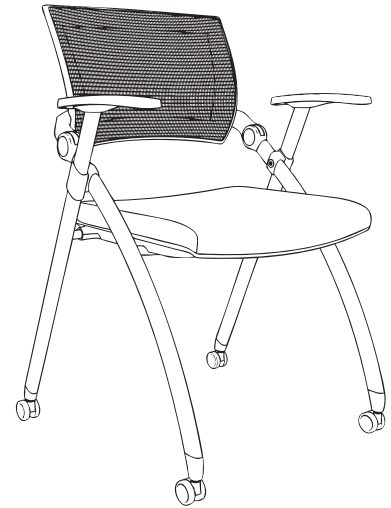

Jiminy mesh back models may be ordered to meet TB133 fire code.

To order seating to meet the TB133 fire code, specify an "F" at the end of the model number (Ex: N52GHMF).

For TB133 pricing go to www.NationalOfficeFurniture.com/TB133

Please consult customer service for applicable Arc-Com, Carnegie, Designtex, Maharam, Mayer, Momentum, Stinson, or Ultrafabrics fabric.

FABRICS

Grade 1 Cali
Entwine
Melange
Ridge
Spark
Vessel
Zig Zag

Grade 2 Bliss
Brilliant
Dolce
Intuition
Orbit
Pixie
Sedona
Stencil
Strand

Grade 3 Silvertex

Grade 4 Connect Four
Echo
Masquerade

Grade 5 Mode

Grade 6 Essence/Ultraleather

Grade 7 Brisa
Brisa Distressed
Reef Pro
Silica
Tottori

FRAME COLORS

462 Cinder
501 Platinum Metallic

CASTERS

C11 Hard (standard)
C12 Soft (add \$36 list)

GLIDES

STD Standard
C21 Soft (add \$34 list)



Shaded models are available through our Quick Delivery program and will be delivered within 10 days or less. Shaded models that feature the 48 icon will ship within 48 hours (48). See page 6 for additional program information.

TO ORDER, SPECIFY:

1. Model Number
2. Fabric Grade Number
3. Cover Number
4. Frame Color
5. Glides or Casters

- See page 321 for Jiminy options
- See page 324 for COM fabric yardage

STATIC



N52GHM



N52GUA

MODEL NO.

GRADE / LIST PRICE

			1	2/COM	3/COL	4	5	6	7	L7	L8
QN52GHM	Armless Mesh	\$	928	956	969	990	1012	1050	1102		
QN52GHA	Arms Mesh		970	998	1011	1032	1054	1092	1144		
QN52GUM	Armless Upholstered		1001	1033	1047	1070	1096	1139	1196		
QN52GUA	Arms Upholstered		1041	1073	1087	1110	1136	1179	1236		

DIMENSIONS

Width	23½	Seat Height	17¾	Arm Height	26½	Weight	23
Depth	22	Seat Depth	16¾	Back Height	16¾	Cubic Ft.	14.5
Height	33½	Seat Width	17½	Back Width	17		

- Chairs will be shipped 4 per carton when applicable

MOBILE



N52GHAC



N52GUMC

			1	2/COM	3/COL	4	5	6	7	L7	L8
QN52GHMC	Armless Mesh	\$	970	998	1011	1032	1054	1092	1144		
QN52GHAC	Arms Mesh		1013	1041	1054	1075	1097	1135	1187		
QN52GUMC	Armless Upholstered		1041	1073	1087	1110	1136	1179	1236		
QN52GUAC	Arms Upholstered		1086	1118	1132	1155	1181	1224	1281		

DIMENSIONS

Width	23½	Seat Height	17¾	Arm Height	26½	Weight	23
Depth	22	Seat Depth	16¾	Back Height	16¾	Cubic Ft.	17
Height	33½	Seat Width	17½	Back Width	17		

- Chairs will be shipped 4 per carton when applicable

KARID

Product Specifications	336
Fabrics and Options	337
Product Pages	339

KARID PRODUCT SPECIFICATIONS

BACK CONSTRUCTION

- Back consists of a metal frame with a 1½" thick polyurethane molded foam overlay with horizontal decorative stitching

HEADREST CONSTRUCTION

- Headrest on high back unit has 4¼" thick molded foam

SEAT CONSTRUCTION

- Seat consists of a plywood core panel with a 4" molded polyurethane foam with piping around the seat edge

ARM CONSTRUCTION

- Static arms are aluminum with a polyurethane black arm cap

CONTRASTING FABRICS

- Contrasting fabric available on all models except the 48 hour Quick Delivery

CONTROL MECHANISM—SYNCHRONOUS TILT

- In synchronous one lock tilt, the backrest and seat pan of a chair recline at a different ratio. For every 2" of back recline, the seat angle tilts 1" (2:1 ratio) as you lean back. This minimizes the seat pan rise as you tilt, allowing your feet to remain on the floor while your gaze remains straight ahead
- Tension control allows for greater spring tension control for a firmer or softer tilting motion. Turn knob counterclockwise to decrease. Tension control is important so that a chair can be adjusted to accommodate users of different body types and sizes and for different work styles. It regulates the amount of resistance you feel when leaning back in the chair, and the effort required to recline backwards

HEIGHT ADJUSTMENT

- The pneumatic height adjustment raises or lowers the seat to the desired height
- Seat height should be adjusted to allow your legs to maintain a 90° angle to the floor or footrest. This keeps pressure off the back of your legs, so blood flow isn't restricted
- 5-star swivel base gives 5" of height adjustment and swivels 360°
- Base comes in polished aluminum or black nylon

CASTERS

- Black/polished 65mm, hard dual-wheel casters are standard
- Soft dual-wheel casters are available as an option on configurable task models

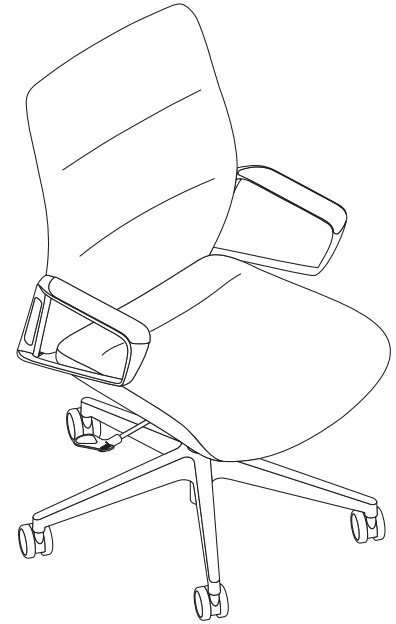

FABRICS

Grade 1 Cali
Entwine
Melange
Ridge
Spark
Vessel
Zig Zag

Grade 2 Bliss
Brilliant
Dolce
Intuition
Orbit
Pixie
Sedona
Stencil
Strand

Grade 3 Silvertex

Grade 4 Connect Four
Echo
Masquerade

Grade 5 Mode

Grade 6 Essence/Ultraleather

Grade 7 Brisa
Brisa Distressed
Reef Pro
Silica
Tottori

CASTERS

C62 Hard 65mm Polished/Black Dual Wheel
For Use On Carpet
C63 Soft 65mm Polished/Black Dual Wheel
For Use On Hard Floors (add \$41 list)



Shaded models are available through our Quick Delivery program and will be delivered within 10 days or less. Shaded models that feature the 48 icon will ship within 48 hours (48). See page 6 for additional program information.

TO ORDER, SPECIFY:

1. Model Number
2. Fabric Grade Number
3. Cover Number
4. Base
5. Casters

- See page 337 for Karid options
- See page 340 for COM fabric yardage

**EXECUTIVE MID BACK
CONFERENCE ARMS
SYNCHRONOUS**



48

MODEL NO. GRADE / LIST PRICE

N42BME8SA	Black Faux Leather, Polished Aluminum Base	\$ 1135
-----------	--	---------

DIMENSIONS

Width	25¼	Seat Height	16½-21¼	Arm Height	24¼	Weight	46.3
Depth	25½	Seat Depth	18¼	Arm Width	2	Cubic Ft.	7.1
Height	38¼	Seat Width	19¼				

- Pack option is not available on Quick Delivery models

LAUDIO

Product Specifications	356
Fabrics and Options	357
Product Pages	358

LAUDIO PRODUCT SPECIFICATIONS

SEAT CONSTRUCTION

- 2" of polyurethane foam covers a 12 mm cross-banded plywood seat panel

BACK CONSTRUCTION

- Injection molded outer frame

MESH

- 100% polyester

ARMS

- Encased uprights are made of reinforced glass filled nylon
- Height adjustable arm adjusts in height with a push button to one of 4 positions with a 5¼" range
- Arm width adjustment allows arm pad to adjust within a 1½" range
- Arm depth adjustment allows arm pad to adjust within a 1¾" range
- Arm pads are soft polyurethane

CONTROL

- Synchronous control features adjustable tension and back lock
- Standard pneumatic gas cylinder lift allows seat to raise and lower 4"
- Seat slide option adjusts seat depth within a 2" range

BASE AND CASTERS

- Black nylon 5-prong base features glass filled nylon for beauty and long life
- Black, multi-surface 60 mm double wheel casters, work on all surfaces, are standard



FABRICS

Grade 1
 Cali
 Entwine
 Melange
 Ridge
 Spark
 Vessel
 Zig Zag

Grade 2
 Bliss
 Brilliant
 Dolce
 Intuition
 Orbit
 Pixie
 Sedona
 Stencil
 Strand

Grade 3
 Silvertex

Grade 4
 Connect Four
 Echo
 Masquerade

Grade 5
 Mode

Grade 6
 Essence/Ultraleather

Grade 7
 Brisa
 Brisa Distressed
 Reef Pro
 Silica
 Tottori

FRAME COLORS

BK Black
 GR Grey

MESH COLORS

BK Black
 BL Blue
 GN Green
 LG Light Grey
 MG Medium Grey
 RD Red



Shaded models are available through our Quick Delivery program and will be delivered within 10 days or less. Shaded models that feature the 48 icon will ship within 48 hours (48). See page 6 for additional program information.

TO ORDER, SPECIFY:

1. Model Number
2. Pack
3. Frame Color
4. Mesh Color
5. Fabric Grade / Cover Number

- See page 357 for Laudio options
- See page 360 for COM fabric yardage

**BLACK MESH BACK
HEIGHT ADJUSTABLE
ARMS**



48

MODEL NO. GRADE / LIST PRICE

N27MM3PSB	Black Mesh, Black Seat Only, Seat Slide	\$ 963
-----------	---	--------

DIMENSIONS

Width	26¼-28	Arm Height	24½- 30¼	Seat Depth with		Weight with	
Depth with		Seat Height with		Seat Slide	17¾-19¼	Seat Slide	45
Seat Slide	26¾-28¾	Seat Slide	16-19%	Back Height	23½	Cubic Ft.	8.0
Height	37¾-41½	Seat Width	20¼	Back Width	18¼		

- Some assembly required, tool included
- Seat fabric is 100% polyester

**MESH BACK
ARMLESS**



	1	2/COM	3/COL	4	5	6	7	L7	L8
QN27MM1P	\$ 1002	1037	1053	1079	1107	1155	1219		
QN27MM1PS	Seat Slide	1030	1065	1081	1107	1135	1183	1247	

DIMENSIONS

Width	24¼	Seat Height	15½-19¼	Seat Depth	17¼	Weight	37
Depth	25¼	Seat Height with		Seat Depth with		Weight with	
Depth with		Seat Slide	16-19%	Seat Slide	17¾-19¼	Seat Slide	40
Seat Slide	26¾-28¾	Seat Width	21	Back Height	23½	Cubic Ft.	13.0
Height	37¾-41½			Back Width	18¼		

**MESH BACK
STATIC ARMS**



	1	2/COM	3/COL	4	5	6	7	L7	L8
QN27MM2P	\$ 1057	1092	1108	1134	1162	1210	1274		
QN27MM2PS	Seat Slide	1085	1120	1136	1162	1190	1238	1302	

DIMENSIONS

Width	26¼-28	Arm Height	25½	Seat Depth	17¼	Weight	42
Depth	25¼	Seat Height	15½-19¼	Seat Depth with		Weight with	
Depth with		Seat Height with		Seat Slide	17¾-19¼	Seat Slide	45
Seat Slide	26¾-28¾	Seat Slide	16-19%	Back Height	23½	Cubic Ft.	13.0
Height	37¾-41½	Seat Width	20¼	Back Width	18¼		



Shaded models are available through our Quick Delivery program and will be delivered within 10 days or less. Shaded models that feature the 48 icon will ship within 48 hours (48). See page 6 for additional program information.

TO ORDER, SPECIFY:

1. Model Number
2. Pack
3. Frame Color
4. Mesh Color
5. Fabric Grade / Cover Number

• See page 357 for Laudio options
See page 360 for COM fabric yardage

**MESH BACK
HEIGHT ADJUSTABLE
ARMS**



MODEL NO.	GRADE / LIST PRICE									
	1	2/COM	3/COL	4	5	6	7	L7	L8	
QN27MM3P	\$ 1070	1105	1121	1147	1175	1223	1287			
QN27MM3PS Seat Slide	1098	1133	1149	1175	1203	1251	1315			

DIMENSIONS

Width	26¼-28	Arm Height	24½-30¼	Seat Depth	17¼	Weight	42
Depth	25¼	Seat Height	15½-19¼	Seat Depth with		Weight with	
Depth with		Seat Height with		Seat Slide	17¼-19¼	Seat Slide	45
Seat Slide	26¾-28¾	Seat Slide	16-19%	Back Height	23½	Cubic Ft.	13.0
Height	37¼-41½	Seat Width	20¼	Back Width	18¼		

**MESH BACK
WITH HEADREST
STATIC ARMS**



MODEL NO.	GRADE / LIST PRICE									
	1	2/COM	3/COL	4	5	6	7	L7	L8	
QN27MHM2P	\$ 1162	1197	1213	1239	1267	1315	1379			
QN27MHM2PS Seat Slide	1188	1223	1239	1265	1293	1341	1405			

DIMENSIONS

Width	26¼-28	Arm Height	25½	Seat Depth	17¼	Weight	44
Depth	25¼	Seat Height	15½-19¼	Seat Depth with		Weight with	
Depth with		Seat Height with		Seat Slide	17¼-19¼	Seat Slide	47
Seat Slide	26¾-28¾	Seat Slide	16-19%	Back Height	23½	Cubic Ft.	13.0
Height	41¼-46¼	Seat Width	20¼	Back Width	18¼		

**MESH BACK
WITH HEADREST
HEIGHT ADJUSTABLE
ARMS**



MODEL NO.	GRADE / LIST PRICE									
	1	2/COM	3/COL	4	5	6	7	L7	L8	
QN27MHM3P	\$ 1174	1209	1225	1251	1279	1327	1391			
QN27MHM3PS Seat Slide	1202	1237	1253	1279	1307	1355	1419			

DIMENSIONS

Width	26¼-28	Arm Height	24½-30¼	Seat Depth	17¼	Weight	44
Depth	25¼	Seat Height	15½-19¼	Seat Depth with		Weight with	
Depth with		Seat Height with		Seat Slide	17¼-19¼	Seat Slide	47
Seat Slide	26¾-28¾	Seat Slide	16-19%	Back Height	23½	Cubic Ft.	13.0
Height	41¼-46¼	Seat Width	20¼	Back Width	18¼		

LAVORO

Product Specifications	362
Fabrics and Options	363
Product Pages	365

LAVORO PRODUCT SPECIFICATIONS

FRAME CONSTRUCTION

GUEST MODELS

- Legs and cross members are made of 1" tubular steel
- Available in polished aluminum or Cinder powder coat

SEAT CONSTRUCTION

TASK MODELS

- 2½" of high grade polyurethane foam covers a contoured injection molded seat panel

GUEST MODELS

- 1½" of high grade polyurethane foam covers an injection molded seat panel

BACK CONSTRUCTION

TASK MODELS

- Injection molded polypropylene outer shell
- Injection molded polyethylene inner back shell designed with deep ribbing to provide extra support
- Upholstered back features 1" of custom molded foam

GUEST MODELS

- Injection molded polypropylene inner and outer back panels
- Upholstered back features 1" of custom molded foam

BACK REST (UPHOLSTERED BACK MODELS)

- Back height can be adjusted by simply lifting up on the back of upholstered back models
- The range of adjustment is approximately 3"

MESH

- 100% polypropylene
- Cleaning code: W
- 100,000+ double rubs

LUMBAR (MESH BACK MODELS)

- Lumbar on mesh back adjusts approximately 2¼" by simply lifting and lowering the lumbar pad
- Cannot be field installed to non-lumbar models

ARMS

- Encased uprights are made of reinforced nylon or polished aluminum
- Height adjustable arms adjust in height with a push button to 1 of 8 positions within a 3" range
- Arms with width adjustment allow arms to adjust within a 2½" range
- Arms with depth adjustment allows arm pad to adjust within a 2" range
- Arm pads are soft black polyurethane
- Guest arms are black glass filled polypropylene

CONFERENCE ARMS

- Die cast polished aluminum
- Arm pads are soft black polyurethane

CONTROL MECHANISM

- Synchronous tilt control allows the back and seat to move in a synchronized 2.3:1 ratio motion
- Free float feature allows the chair to tilt freely
- The back angle can be locked in infinite position
- Standard pneumatic gas cylinder lift allows seat to raise and lower 5" and provides spring action for added comfort
- Seat slide option adjusts seat depth within a 2¼" range

BASE AND CASTERS

- Features a 5-prong black glass filled nylon base or a polished cast aluminum base
- All bases have black, hard double wheel casters, which work on multiple surfaces
- Black, soft double wheel casters are available for use on hard floors; upcharge applies to this option

GLIDE

- Durable hard black nylon glides are standard
- Soft glides are available for an upcharge

GUEST STACKING

- Plastic seat models can be stacked up to 4 high
- Stacking upholstered seat models is not recommended

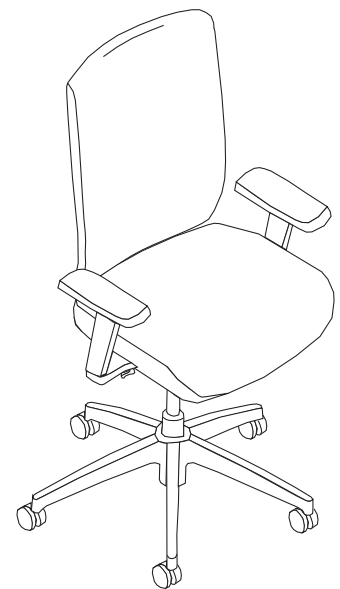
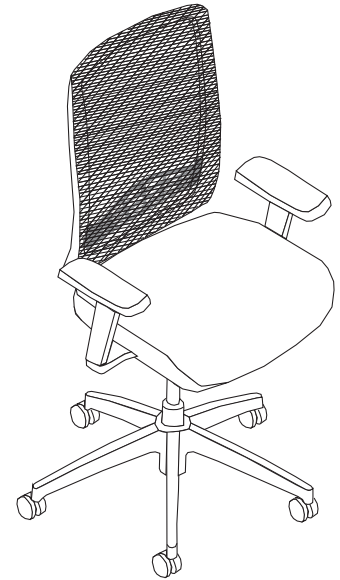

All Lavoro upholstered back models may be ordered to meet TB133 fire code.

To order seating to meet the TB133 fire code, specify an "F" at the end of the model number (Ex: N30HP1SPF).

For TB133 pricing go to www.NationalOfficeFurniture.com/TB133

Please consult customer service for applicable Arc-Com, Carnegie, Designtex, Maharam, Mayer, Momentum, Stinson, or Ultrafabrics fabric.

FABRICS

Grade 1
Cali
Entwine
Melange
Ridge
Spark
Vessel
Zig Zag

Grade 2
Bliss
Brilliant
Dolce
Intuition
Orbit
Pixie
Sedona
Stencil
Strand

Grade 3
Silvertex

Grade 4
Connect Four
Echo
Masquerade

Grade 5
Mode

Grade 6
Essence/Ultraleather

Grade 7
Brisa
Brisa Distressed
Reef Pro
Silica
Tottori

CASTERS**ALL MODELS**

C3 Hard (standard)
C4 Soft (add \$36 list)

GLIDES**FOR TASK STOOL MODELS**

C54 Hard (standard)
C55 Soft (add \$36 list)

FOR GUEST MODELS

C53 Hard (standard)
C52 Soft (add \$36 list)



Shaded models are available through our Quick Delivery program and will be delivered within 10 days or less. Shaded models that feature the 48 icon will ship within 48 hours (48). See page 6 for additional program information.

TO ORDER, SPECIFY:

1. Model Number
2. Pack
3. Mesh Color
4. Fabric Grade / Cover Number
5. Caster or Glide

- See page 363 for Lavoro options
- See pages 391-393 for COM fabric yardage

**HIGH BACK
MESH
ARMLESS**

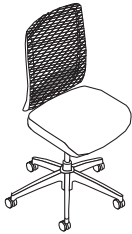

MODEL NO.	GRADE / LIST PRICE								
		1	2/COM	3/COL	4	5	6	7	L7
QN30HM1SP	\$ 987	1015	1028	1049	1071	1109	1161		
QN30HML1SP	Lumbar	1098	1126	1139	1160	1182	1220	1272	
QN30HM1SSP	Seat Slide	1121	1149	1162	1183	1205	1243	1295	
QN30HML1SSP	Lumbar, Seat Slide	1232	1260	1273	1294	1316	1354	1406	
QN30HM1SN	Polished Aluminum	1137	1165	1178	1199	1221	1259	1311	
QN30HML1SN	Lumbar, Polished Aluminum	1247	1275	1288	1309	1331	1369	1421	
QN30HM1SSN	Seat Slide, Polished Aluminum	1272	1300	1313	1334	1356	1394	1446	
QN30HML1SSN	Lumbar, Seat Slide, Polished Aluminum	1382	1410	1423	1444	1466	1504	1556	

DIMENSIONS

Width	25¼	Seat Height	16¾-21¾	Seat Depth	17	Weight	52
Depth	25¼	Seat Height with		Seat Depth with		FA Cubic Ft.	18.7
Depth with		Seat Slide	17¼-22¼	Seat Slide	16½-18¾	KD Cubic Ft.	15.0
Seat Slide	25¼-27¾	Seat Width	20¼	Back Height	25		
Height	42¼-47			Back Width	17¾		

• All height measurements for polished aluminum base models are ½" less than shown above



Shaded models are available through our Quick Delivery program and will be delivered within 10 days or less. Shaded models that feature the 48 icon will ship within 48 hours (48). See page 6 for additional program information.

TO ORDER, SPECIFY:

1. Model Number
2. Pack
3. Mesh Color
4. Fabric Grade / Cover Number
5. Caster or Glide

• See page 363 for Lavoro options

See pages 391-393 for COM fabric yardage

**HIGH BACK
MESH
HEIGHT, ARM CAP DEPTH**



**MODEL
NO.**

GRADE / LIST PRICE

		1	2/COM	3/COL	4	5	6	7	L7	L8
QN30HM2SP		\$ 1137	1165	1178	1199	1221	1259	1311		
QN30HML2SP	Lumbar	1247	1275	1288	1309	1331	1369	1421		
QN30HM2SSP	Seat Slide	1272	1300	1313	1334	1356	1394	1446		
QN30HML2SSP	Lumbar, Seat Slide	1382	1410	1423	1444	1466	1504	1556		
QN30HM2SN	Polished Aluminum	1285	1313	1326	1347	1369	1407	1459		
QN30HML2SN	Lumbar, Polished Aluminum	1397	1425	1438	1459	1481	1519	1571		
QN30HM2SSN	Seat Slide, Polished Aluminum	1422	1450	1463	1484	1506	1544	1596		
QN30HML2SSN	Lumbar, Seat Slide, Polished Aluminum	1532	1560	1573	1594	1616	1654	1706		

DIMENSIONS

Width	26½	Arm Height	24¾- 32½	Seat Depth	17	Weight	52
Depth	25¼	Arm Width	19¼	Seat Depth with		FA Cubic Ft.	18.7
Depth with		Seat Height	16¾-21¼	Seat Slide	16½-18¾	KD Cubic Ft.	15.0
Seat Slide	25¼-27¾	Seat Height with		Back Height	25		
Height	42¼-47	Seat Slide	17¾-22¼	Back Width	17¾		
		Seat Width	20¼				

• All height measurements for polished aluminum base models are ½" less than shown above



Shaded models are available through our Quick Delivery program and will be delivered within 10 days or less. Shaded models that feature the 48 icon will ship within 48 hours (48). See page 6 for additional program information.

TO ORDER, SPECIFY:

1. Model Number
2. Pack
3. Mesh Color
4. Fabric Grade / Cover Number
5. Caster or Glide

- See page 363 for Lavoro options
- See pages 391-393 for COM fabric yardage

**HIGH BACK
MESH
HEIGHT, WIDTH,
ARM CAP DEPTH**



**MODEL
NO.**

GRADE / LIST PRICE

		1	2/COM	3/COL	4	5	6	7	L7	L8
QN30HM3SP		\$ 1212	1240	1253	1274	1296	1334	1386		
QN30HML3SP	Lumbar	1323	1351	1364	1385	1407	1445	1497		
QN30HM3SSP	Seat Slide	1344	1372	1385	1406	1428	1466	1518		
QN30HML3SSP	Lumbar, Seat Slide	1459	1487	1500	1521	1543	1581	1633		
QN30HM3SN	Polished Aluminum	1360	1388	1401	1422	1444	1482	1534		
QN30HML3SN	Lumbar, Polished Aluminum	1473	1501	1514	1535	1557	1595	1647		
QN30HM3SSN	Seat Slide, Polished Aluminum	1494	1522	1535	1556	1578	1616	1668		
QN30HML3SSN	Lumbar, Seat Slide, Polished Aluminum	1609	1637	1650	1671	1693	1731	1783		

DIMENSIONS

Width	28¼	Arm Height	24¼- 32½	Seat Depth	17	Weight	52
Depth	25¼	Arm Width	18¼-20½	Seat Depth with		FA Cubic Ft.	18.7
Depth with		Seat Height	16¼-21¼	Seat Slide	16½-18¾	KD Cubic Ft.	15.0
Seat Slide	25¼-27¾	Seat Height with		Back Height	25		
Height	42¼-47	Seat Slide	17¼-22¼	Back Width	17¼		
		Seat Width	20¼				

• All height measurements for polished aluminum base models are ½" less than shown above



Shaded models are available through our Quick Delivery program and will be delivered within 10 days or less. Shaded models that feature the 48 icon will ship within 48 hours (48). See page 6 for additional program information.

TO ORDER, SPECIFY:

1. Model Number
2. Pack
3. Mesh Color
4. Fabric Grade / Cover Number
5. Caster or Glide

• See page 363 for Lavoro options

See pages 391-393 for COM fabric yardage

**HIGH BACK
MESH
STATIC ARMS**



**MODEL
NO.**

GRADE / LIST PRICE

		1	2/COM	3/COL	4	5	6	7	L7	L8
QN30HM9SP		\$ 1063	1091	1104	1125	1147	1185	1237		
QN30HML9SP	Lumbar	1174	1202	1215	1236	1258	1296	1348		
QN30HM9SSP	Seat Slide	1196	1224	1237	1258	1280	1318	1370		
QN30HML9SSP	Lumbar, Seat Slide	1308	1336	1349	1370	1392	1430	1482		
QN30HM9SN	Polished Aluminum	1212	1240	1253	1274	1296	1334	1386		
QN30HML9SN	Lumbar, Polished Aluminum	1323	1351	1364	1385	1407	1445	1497		
QN30HM9SSN	Seat Slide, Polished Aluminum	1344	1372	1385	1406	1428	1466	1518		
QN30HML9SSN	Lumbar, Seat Slide, Polished Aluminum	1459	1487	1500	1521	1543	1581	1633		

DIMENSIONS

Width	26½	Arm Height	26¾-31½	Seat Depth	17	Weight	52
Depth	25¼	Arm Width	19½	Seat Depth with		FA Cubic Ft.	18.7
Depth with		Seat Height	16¾-21¼	Seat Slide	16½-18¾	KD Cubic Ft.	15.0
Seat Slide	25¼-27¾	Seat Height with		Back Height	25		
Height	42¼-47	Seat Slide	17¾-22¼	Back Width	17¾		
		Seat Width	20¼				

• All height measurements for polished aluminum base models are ½" less than shown above



Shaded models are available through our Quick Delivery program and will be delivered within 10 days or less. Shaded models that feature the 48 icon will ship within 48 hours (48). See page 6 for additional program information.

TO ORDER, SPECIFY:

1. Model Number
2. Pack
3. Mesh Color
4. Fabric Grade / Cover Number
5. Caster or Glide

• See page 363 for Lavoro options
See pages 391-393 for COM fabric yardage

**HIGH BACK
MESH
CONFERENCE ARMS**



MODEL NO.

GRADE / LIST PRICE

		1	2/COM	3/COL	4	5	6	7	L7	L8
QN30HM8SN	Polished Aluminum	\$ 1510	1538	1551	1572	1594	1632	1684		
QN30HML8SN	Lumbar, Polished Aluminum	1621	1649	1662	1683	1705	1743	1795		
QN30HM8SSN	Seat Slide, Polished Aluminum	1645	1673	1686	1707	1729	1767	1819		
QN30HML8SSN	Lumbar, Seat Slide, Polished Aluminum	1757	1785	1798	1819	1841	1879	1931		

DIMENSIONS

Width	25½	Arm Height	26¾-31½	Seat Depth	17	Weight	52
Depth	25¼	Arm Width	20¾	Seat Depth with		FA Cubic Ft.	18.7
Depth with		Seat Height	16¾-21¼	Seat Slide	16½-18¾	KD Cubic Ft.	15.0
Seat Slide	25¼-27¾	Seat Height with		Back Height	25		
Height	41¾-46½	Seat Slide	17¼-22¼	Back Width	17¾		
		Seat Width	20¾				



Shaded models are available through our Quick Delivery program and will be delivered within 10 days or less. Shaded models that feature the 48 icon will ship within 48 hours (48). See page 6 for additional program information.

TO ORDER, SPECIFY:

1. Model Number
2. Pack
3. Fabric Grade / Cover Number
4. Caster or Glide

• See page 363 for Lavoro options

See pages 391-393 for COM fabric yardage

**HIGH BACK
UPHOLSTERED
ARMLESS**

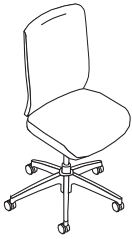

**MODEL
NO.**

GRADE / LIST PRICE

		1	2/COM	3/COL	4	5	6	7	L7	L8
QN30HP1SP	Plastic Extreme Back	\$ 1166	1212	1232	1266	1303	1365	1448		
QN30HP1SSP	Plastic Extreme Back, Seat Slide	1300	1346	1366	1400	1437	1499	1582		
QN30HP1SN	Plastic Extreme Back, Polished Aluminum	1317	1363	1383	1417	1454	1516	1599		
QN30HP1SSN	Plastic Extreme Back, Seat Slide, Polished Aluminum	1450	1496	1516	1550	1587	1649	1732		
QN30HU1SP	Upholstered Back, Plastic Base	1241	1294	1318	1357	1399	1471	1567		
QN30HU1SSP	Upholstered Back, Seat Slide	1375	1428	1452	1491	1533	1605	1701		
QN30HU1SN	Upholstered Back, Polished Aluminum	1389	1442	1466	1505	1547	1619	1715		
QN30HU1SSN	Upholstered Back, Seat Slide, Polished Aluminum	1524	1577	1601	1640	1682	1754	1850		

DIMENSIONS

Width	25¼	Seat Height	16¾-21¼	Seat Depth	17	Weight	53
Depth	25¼	Seat Height with		Seat Depth with		FA Cubic Ft.	18.7
Depth with		Seat Slide	17¼-22¼	Seat Slide	16½-18¾	KD Cubic Ft.	15.0
Seat Slide	25¼-27¾	Seat Width	20¼	Back Height	24¼-27		
Height	42¼-47			Back Width	18¼		

• All height measurements for polished aluminum base models are ½" less than shown above



Shaded models are available through our Quick Delivery program and will be delivered within 10 days or less. Shaded models that feature the 48 icon will ship within 48 hours (48). See page 6 for additional program information.

TO ORDER, SPECIFY:

1. Model Number
2. Pack
3. Fabric Grade / Cover Number
4. Caster or Glide

- See page 363 for Lavoro options
- See pages 391-393 for COM fabric yardage

**HIGH BACK
UPHOLSTERED
HEIGHT, ARM CAP DEPTH**



**MODEL
NO.**

GRADE / LIST PRICE

			1	2/COM	3/COL	4	5	6	7	L7	L8
QN30HP2SP	Plastic Extreme Back	\$	1317	1363	1383	1417	1454	1516	1599		
QN30HP2SSP	Plastic Extreme Back, Seat Slide		1450	1496	1516	1550	1587	1649	1732		
QN30HP2SN	Plastic Extreme Back, Polished Aluminum		1465	1511	1531	1565	1602	1664	1747		
QN30HP2SSN	Plastic Extreme Back, Seat Slide, Polished Aluminum		1599	1645	1665	1699	1736	1798	1881		
QN30HU2SP	Upholstered Back, Plastic Base		1389	1442	1466	1505	1547	1619	1715		
QN30HU2SSP	Upholstered Back, Seat Slide		1524	1577	1601	1640	1682	1754	1850		
QN30HU2SN	Upholstered Back, Polished Aluminum		1540	1593	1617	1656	1698	1770	1866		
QN30HU2SSN	Upholstered Back, Seat Slide, Polished Aluminum		1673	1726	1750	1789	1831	1903	1999		

DIMENSIONS

Width	26½	Arm Height	24¾-32½	Seat Depth	17	Weight	53
Depth	25¼	Arm Width	19¼	Seat Depth with		FA Cubic Ft.	18.7
Depth with		Seat Height	16¾-21¼	Seat Slide	16½-18¼	KD Cubic Ft.	15.0
Seat Slide	25¼-27¼	Seat Height with		Back Height	24¼-27		
Height	42¼-47	Seat Slide	17¼-22¼	Back Width	18¼		
		Seat Width	20¼				

• All height measurements for polished aluminum base models are ½" less than shown above



Shaded models are available through our Quick Delivery program and will be delivered within 10 days or less. Shaded models that feature the 48 icon will ship within 48 hours (48). See page 6 for additional program information.

TO ORDER, SPECIFY:

1. Model Number
2. Pack
3. Fabric Grade / Cover Number
4. Caster or Glide

• See page 363 for Lavoro options

See pages 391-393 for COM fabric yardage

**HIGH BACK
UPHOLSTERED
HEIGHT, WIDTH,
ARM CAP DEPTH**



**MODEL
NO.**

GRADE / LIST PRICE

		1	2/COM	3/COL	4	5	6	7	L7	L8
QN30HP3SP	Plastic Extreme Back	\$ 1389	1435	1455	1489	1526	1588	1671		
QN30HP3SSP	Plastic Extreme Back, Seat Slide	1524	1570	1590	1624	1661	1723	1806		
QN30HP3SN	Plastic Extreme Back, Polished Aluminum	1540	1586	1606	1640	1677	1739	1822		
QN30HP3SSN	Plastic Extreme Back, Seat Slide, Polished Aluminum	1673	1719	1739	1773	1810	1872	1955		
QN30HU3SP	Upholstered Back	1465	1518	1542	1581	1623	1695	1791		
QN30HU3SSP	Upholstered Back, Seat Slide	1599	1652	1676	1715	1757	1829	1925		
QN30HU3SN	Upholstered Back, Polished Aluminum	1616	1669	1693	1732	1774	1846	1942		
QN30HU3SSN	Upholstered Back, Seat Slide, Polished Aluminum	1749	1802	1826	1865	1907	1979	2075		

DIMENSIONS

Width	25½	Arm Height	24¾-32½	Seat Depth	17	Weight	53
Depth	25¼	Arm Width	18¾-20½	Seat Depth with		FA Cubic Ft.	18.7
Depth with		Seat Height	16¾-21¾	Seat Slide	16½-18¾	KD Cubic Ft.	15.0
Seat Slide	25½-27¾	Seat Height with		Back Height	24¼-27		
Height	42¼-47	Seat Slide	17¼-22¼	Back Width	18¾		
		Seat Width	20¾				

• All height measurements for polished aluminum base models are ½" less than shown above



Shaded models are available through our Quick Delivery program and will be delivered within 10 days or less. Shaded models that feature the 48 icon will ship within 48 hours (48). See page 6 for additional program information.

TO ORDER, SPECIFY:

1. Model Number
2. Pack
3. Fabric Grade / Cover Number
4. Caster or Glide

- See page 363 for Lavoro options
- See pages 391-393 for COM fabric yardage

**HIGH BACK
UPHOLSTERED
STATIC ARMS**



MODEL NO.	GRADE / LIST PRICE										
		1	2/COM	3/COL	4	5	6	7	L7	L8	
QN30HP9SP	Plastic Extreme Back	\$ 1241	1287	1307	1341	1378	1440	1523			
QN30HP9SSP	Plastic Extreme Back, Seat Slide	1375	1421	1441	1475	1512	1574	1657			
QN30HP9SN	Plastic Extreme Back, Polished Aluminum	1389	1435	1455	1489	1526	1588	1671			
QN30HP9SSN	Plastic Extreme Back, Seat Slide, Polished Aluminum	1524	1570	1590	1624	1661	1723	1806			
QN30HU9SP	Upholstered Back	1317	1370	1394	1433	1475	1547	1643			
QN30HU9SSP	Upholstered Back, Seat Slide	1450	1503	1527	1566	1608	1680	1776			
QN30HU9SN	Upholstered Back, Polished Aluminum	1465	1518	1542	1581	1623	1695	1791			
QN30HU9SSN	Upholstered Back, Seat Slide, Polished Aluminum	1599	1652	1676	1715	1757	1829	1925			

DIMENSIONS

Width	25½	Arm Height	26¾-31½	Seat Depth	17	Weight	53
Depth	25¼	Arm Width	19½	Seat Depth with		FA Cubic Ft.	18.7
Depth with		Seat Height	16¾-21¾	Seat Slide	16½-18¾	KD Cubic Ft.	15.0
Seat Slide	25½-27¾	Seat Height with		Back Height	24¼-27		
Height	42¼-47	Seat Slide	17¼-22¼	Back Width	18¾		
		Seat Width	20¾				

- All height measurements for polished aluminum base models are ½" less than shown above



Shaded models are available through our Quick Delivery program and will be delivered within 10 days or less. Shaded models that feature the 48 icon will ship within 48 hours (48). See page 6 for additional program information.

TO ORDER, SPECIFY:

1. Model Number
2. Pack
3. Fabric Grade / Cover Number
4. Caster or Glide

• See page 363 for Lavoro options

See pages 391-393 for COM fabric yardage

**HIGH BACK
UPHOLSTERED
CONFERENCE ARMS**



**MODEL
NO.**

GRADE / LIST PRICE

		1	2/COM	3/COL	4	5	6	7	L7	L8
QN30HP8SN	Plastic Extreme Back, Polished Aluminum	\$ 1689	1735	1755	1789	1826	1888	1971		
QN30HP8SSN	Plastic Extreme Back, Seat Slide, Polished Aluminum	1824	1870	1890	1924	1961	2023	2106		
QN30HU8SN	Upholstered Back, Polished Aluminum	1763	1816	1840	1879	1921	1993	2089		
QN30HU8SSN	Upholstered Back, Seat Slide, Polished Aluminum	1898	1951	1975	2014	2056	2128	2224		

DIMENSIONS

Width	25½	Arm Height	26¾- 31½	Seat Depth	16½	Weight	53
Depth	25¼	Arm Width	20¼	Seat Depth with		FA Cubic Ft.	18.7
Depth with		Seat Height	16¼-21¼	Seat Slide	16½-18¼	KD Cubic Ft.	15.0
Seat Slide	25½-27¾	Seat Height with		Back Height	24¼-27		
Height	41¾-46½	Seat Slide	17¼-22¼	Back Width	18¼		
		Seat Width	20¼				



Shaded models are available through our Quick Delivery program and will be delivered within 10 days or less. Shaded models that feature the 48 icon will ship within 48 hours (48). See page 6 for additional program information.

TO ORDER, SPECIFY:

1. Model Number
2. Pack
3. Fabric Grade / Cover Number
4. Caster or Glide

- See page 363 for Lavoro options
- See pages 391-393 for COM fabric yardage

**MID BACK
UPHOLSTERED
ARMLESS**



MODEL NO.	GRADE / LIST PRICE	GRADE / LIST PRICE								
		1	2/COM	3/COL	4	5	6	7	L7	L8
QN30MP1SP	Plastic Extreme Back	\$ 1098	1140	1159	1190	1224	1282	1358		
QN30MP1SSP	Plastic Extreme Back, Seat Slide	1232	1274	1293	1324	1358	1416	1492		
QN30MP1SN	Plastic Extreme Back, Polished Aluminum	1247	1289	1308	1339	1373	1431	1507		
QN30MP1SSN	Plastic Extreme Back, Seat Slide, Polished Aluminum	1382	1424	1443	1474	1508	1566	1642		
QN30MU1SP	Upholstered Back	1174	1223	1245	1282	1321	1388	1478		
QN30MU1SSP	Upholstered Back, Seat Slide	1308	1357	1379	1416	1455	1522	1612		
QN30MU1SN	Upholstered Back, Polished Aluminum	1323	1372	1394	1431	1470	1537	1627		
QN30MU1SSN	Upholstered Back, Seat Slide, Polished Aluminum	1459	1508	1530	1567	1606	1673	1763		

DIMENSIONS

Width	25¼	Seat Height	16¾-21¾	Seat Depth	16½	Weight	50
Depth	25¼	Seat Height with		Seat Depth with		FA Cubic Ft.	16.3
Depth with		Seat Slide	17¼-22¼	Seat Slide	16½-18¾	KD Cubic Ft.	15.0
Seat Slide	25½-27¾	Seat Width	20¼	Back Height	22¼-24¾		
Height	39½-44			Back Width	18		

• All height measurements for polished aluminum base models are ½" less than shown above



Shaded models are available through our Quick Delivery program and will be delivered within 10 days or less. Shaded models that feature the 48 icon will ship within 48 hours (48). See page 6 for additional program information.

TO ORDER, SPECIFY:

1. Model Number
2. Pack
3. Fabric Grade / Cover Number
4. Caster or Glide

• See page 363 for Lavoro options

See pages 391-393 for COM fabric yardage

**MID BACK
UPHOLSTERED
HEIGHT, ARM CAP DEPTH**



**MODEL
NO.**

GRADE / LIST PRICE

		1	2/COM	3/COL	4	5	6	7	L7	L8
QN30MP2SP	Plastic Extreme Back	\$ 1247	1289	1308	1339	1373	1431	1507		
QN30MP2SSP	Plastic Extreme Back, Seat Slide	1382	1424	1443	1474	1508	1566	1642		
QN30MP2SN	Plastic Extreme Back, Polished Aluminum	1397	1439	1458	1489	1523	1581	1657		
QN30MP2SSN	Plastic Extreme Back, Seat Slide, Polished Aluminum	1532	1574	1593	1624	1658	1716	1792		
QN30MU2SP	Upholstered Back	1323	1372	1394	1431	1470	1537	1627		
QN30MU2SSP	Upholstered Back, Seat Slide	1459	1508	1530	1567	1606	1673	1763		
QN30MU2SN	Upholstered Back, Polished Aluminum	1473	1522	1544	1581	1620	1687	1777		
QN30MU2SSN	Upholstered Back, Seat Slide, Polished Aluminum	1609	1658	1680	1717	1756	1823	1913		

DIMENSIONS

Width	26½	Arm Height	24¾- 32½	Seat Depth	16½	Weight	50
Depth	25¼	Arm Width	19½	Seat Depth with		FA Cubic Ft.	16.3
Depth with		Seat Height	16¾-21¼	Seat Slide	16½-18¾	KD Cubic Ft.	15.0
Seat Slide	25¼-27¾	Seat Height with		Back Height	22¼-24¾		
Height	39½-44	Seat Slide	17¼-22¼	Back Width	18		
		Seat Width	20¼				

• All height measurements for polished aluminum base models are ½" less than shown above



Shaded models are available through our Quick Delivery program and will be delivered within 10 days or less. Shaded models that feature the 48 icon will ship within 48 hours (48). See page 6 for additional program information.

TO ORDER, SPECIFY:

1. Model Number
2. Pack
3. Fabric Grade / Cover Number
4. Caster or Glide

- See page 363 for Lavoro options
- See pages 391-393 for COM fabric yardage

**MID BACK
UPHOLSTERED
HEIGHT, WIDTH,
ARM CAP DEPTH**



**MODEL
NO.**

GRADE / LIST PRICE

		1	2/COM	3/COL	4	5	6	7	L7	L8
QN30MP3SP	Plastic Extreme Back	\$ 1323	1365	1384	1415	1449	1507	1583		
QN30MP3SSP	Plastic Extreme Back, Seat Slide	1459	1501	1520	1551	1585	1643	1719		
QN30MP3SN	Plastic Extreme Back, Polished Aluminum	1473	1515	1534	1565	1599	1657	1733		
QN30MP3SSN	Plastic Extreme Back, Seat Slide, Polished Aluminum	1609	1651	1670	1701	1735	1793	1869		
QN30MU3SP	Upholstered Back	1397	1446	1468	1505	1544	1611	1701		
QN30MU3SSP	Upholstered Back, Seat Slide	1532	1581	1603	1640	1679	1746	1836		
QN30MU3SN	Upholstered Back, Polished Aluminum	1546	1595	1617	1654	1693	1760	1850		
QN30MU3SSN	Upholstered Back, Seat Slide, Polished Aluminum	1681	1730	1752	1789	1828	1895	1985		

DIMENSIONS

Width	26½	Arm Height	24¾-32½	Seat Depth	16½	Weight	50
Depth	25¼	Arm Width	18¾-20½	Seat Depth with		FA Cubic Ft.	16.3
Depth with		Seat Height	16¾-21¾	Seat Slide	16½-18¾	KD Cubic Ft.	15.0
Seat Slide	25¼-27¾	Seat Height with		Back Height	22¼-24¾		
Height	39½-44	Seat Slide	17¼-22¼	Back Width	18		
		Seat Width	20¼				

- All height measurements for polished aluminum base models are ½" less than shown above



Shaded models are available through our Quick Delivery program and will be delivered within 10 days or less. Shaded models that feature the 48 icon will ship within 48 hours (48). See page 6 for additional program information.

TO ORDER, SPECIFY:

1. Model Number
2. Pack
3. Fabric Grade / Cover Number
4. Caster or Glide

• See page 363 for Lavoro options

See pages 391-393 for COM fabric yardage

**MID BACK
UPHOLSTERED
STATIC ARMS**



**MODEL
NO.**

GRADE / LIST PRICE

		1	2/COM	3/COL	4	5	6	7	L7	L8
QN30MP9SP	Plastic Extreme Back	\$ 1174	1216	1235	1266	1300	1358	1434		
QN30MP9SSP	Plastic Extreme Back, Seat Slide	1308	1350	1369	1400	1434	1492	1568		
QN30MP9SN	Plastic Extreme Back, Polished Aluminum	1323	1365	1384	1415	1449	1507	1583		
QN30MP9SSN	Plastic Extreme Back, Seat Slide, Polished Aluminum	1459	1501	1520	1551	1585	1643	1719		
QN30MU9SP	Upholstered Back	1247	1296	1318	1355	1394	1461	1551		
QN30MU9SSP	Upholstered Back, Seat Slide	1382	1431	1453	1490	1529	1596	1686		
QN30MU9SN	Upholstered Back, Polished Aluminum	1397	1446	1468	1505	1544	1611	1701		
QN30MU9SSN	Upholstered Back, Seat Slide, Polished Aluminum	1532	1581	1603	1640	1679	1746	1836		

DIMENSIONS

Width	26½	Arm Height	26¾-31½	Seat Depth	16½	Weight	50
Depth	25¼	Arm Width	19½	Seat Depth with		FA Cubic Ft.	16.3
Depth with		Seat Height	16¾-21¾	Seat Slide	16½-18¾	KD Cubic Ft.	15.0
Seat Slide	25¼-27¾	Seat Height with		Back Height	22¼-24¾		
Height	39½-44	Seat Slide	17¼-22¼	Back Width	18		
		Seat Width	20¼				

• All height measurements for polished aluminum base models are ½" less than shown above



Shaded models are available through our Quick Delivery program and will be delivered within 10 days or less. Shaded models that feature the 48 icon will ship within 48 hours (48). See page 6 for additional program information.

TO ORDER, SPECIFY:

1. Model Number
2. Pack
3. Fabric Grade / Cover Number
4. Caster or Glide

• See page 363 for Lavoro options
See pages 391-393 for COM fabric yardage

**MID BACK
UPHOLSTERED
CONFERENCE ARMS**



**MODEL
NO.**

GRADE / LIST PRICE

		1	2/COM	3/COL	4	5	6	7	L7	L8
QN30MP8SN	Plastic Extreme Back, Polished Aluminum	\$ 1621	1663	1682	1713	1747	1805	1881		
QN30MP8SSN	Plastic Extreme Back, Seat Slide, Polished Aluminum	1757	1799	1818	1849	1883	1941	2017		
QN30MU8SN	Upholstered Back, Polished Aluminum	1695	1744	1766	1803	1842	1909	1999		
QN30MU8SSN	Upholstered Back, Seat Slide, Polished Aluminum	1830	1879	1901	1938	1977	2044	2134		

DIMENSIONS

Width	25½	Arm Height	26¼-31	Seat Depth	16½	Weight	50
Depth	25¼	Arm Width	20¼	Seat Depth with		FA Cubic Ft.	16.3
Depth with		Seat Height	16¼-21¼	Seat Slide	16½-18¾	KD Cubic Ft.	15.0
Seat Slide	25¼-27¾	Seat Height with		Back Height	22¼-24¾		
Height	39-43½	Seat Slide	17¼-22¼	Back Width	18		
		Seat Width	20¼				



Shaded models are available through our Quick Delivery program and will be delivered within 10 days or less. Shaded models that feature the 48 icon will ship within 48 hours (48). See page 6 for additional program information.

TO ORDER, SPECIFY:

1. Model Number
2. Fabric Grade / Cover Number
3. Caster or Glide

• See page 363 for Lavoro options

See pages 391-393 for COM fabric yardage

**STOOL MID BACK
UPHOLSTERED
ARMLESS**

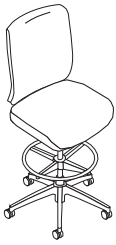

Mobile

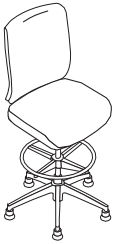

Static

**MODEL
NO.**

GRADE / LIST PRICE

		1	2/COM	3/COL	4	5	6	7	L7	L8
QN30SP1SP	Plastic Extreme Back	\$ 1137	1179	1198	1229	1263	1321	1397		
QN30SP1SPG	Plastic Extreme Back, Glides	1137	1179	1198	1229	1263	1321	1397		
QN30SP1SN	Plastic Extreme Back, Polished Aluminum	1285	1327	1346	1377	1411	1469	1545		
QN30SP1SNG	Plastic Extreme Back, Polished Aluminum, Glides	1285	1327	1346	1377	1411	1469	1545		
QN30SU1SP	Upholstered Back	1247	1296	1318	1355	1394	1461	1551		
QN30SU1SPG	Upholstered Back, Glides	1247	1296	1318	1355	1394	1461	1551		
QN30SU1SN	Upholstered Back, Polished Aluminum	1397	1446	1468	1505	1544	1611	1701		
QN30SU1SNG	Upholstered Back, Polished Aluminum, Glides	1397	1446	1468	1505	1544	1611	1701		

DIMENSIONS

Width	25¼	Seat Height	21-28¾	Back Height	22¼-24¾	Weight	60
Depth	25¼	Seat Depth	16½	Back Width	18	Cubic Ft.	18.7
Height	42¾-53½	Seat Width	20¼				

- All height measurements for polished aluminum base models are ½" less than shown above
- Ships fully assembled



Shaded models are available through our Quick Delivery program and will be delivered within 10 days or less. Shaded models that feature the 48 icon will ship within 48 hours (48). See page 6 for additional program information.

TO ORDER, SPECIFY:

1. Model Number
2. Fabric Grade / Cover Number
3. Caster or Glide

- See page 363 for Lavoro options
- See pages 391-393 for COM fabric yardage

**STOOL MID BACK
UPHOLSTERED
HEIGHT, ARM CAP DEPTH**

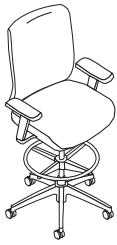

Mobile

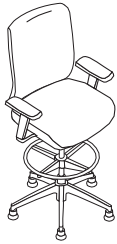

Static



**MODEL
NO.**

GRADE / LIST PRICE

		1	2/COM	3/COL	4	5	6	7	L7	L8
QN30SP2SP	Plastic Extreme Back	\$ 1285	1327	1346	1377	1411	1469	1545		
QN30SP2SPG	Plastic Extreme Back, Glides	1285	1327	1346	1377	1411	1469	1545		
QN30SP2SN	Plastic Extreme Back, Polished Aluminum	1436	1478	1497	1528	1562	1620	1696		
QN30SP2SNG	Plastic Extreme Back, Polished Aluminum, Glides	1436	1478	1497	1528	1562	1620	1696		
QN30SU2SP	Upholstered Back	1397	1446	1468	1505	1544	1611	1701		
QN30SU2SPG	Upholstered Back, Glides	1397	1446	1468	1505	1544	1611	1701		
QN30SU2SN	Upholstered Back, Polished Aluminum	1546	1595	1617	1654	1693	1760	1850		
QN30SU2SNG	Upholstered Back, Polished Aluminum, Glides	1546	1595	1617	1654	1693	1760	1850		

DIMENSIONS

Width	26½	Seat Height	21-28¾	Arm Height	27½-38¾	Weight	60
Depth	25¼	Seat Depth	16½	Arm Width	19¾	Cubic Ft.	18.7
Height	42¾-53½	Seat Width	20¼	Back Height	22¼-24¾		
				Back Width	18		

- All height measurements for polished aluminum base models are ½" less than shown above
- Ships fully assembled



Shaded models are available through our Quick Delivery program and will be delivered within 10 days or less. Shaded models that feature the 48 icon will ship within 48 hours (48). See page 6 for additional program information.

TO ORDER, SPECIFY:

1. Model Number
2. Fabric Grade / Cover Number
3. Caster or Glide

• See page 363 for Lavoro options

See pages 391-393 for COM fabric yardage

**STOOL MID BACK
UPHOLSTERED
HEIGHT, WIDTH,
ARM CAP DEPTH**



Mobile

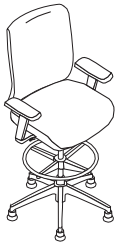

Static



**MODEL
NO.**

GRADE / LIST PRICE

		1	2/COM	3/COL	4	5	6	7	L7	L8
QN30SP3SP	Plastic Extreme Back	\$ 1360	1402	1421	1452	1486	1544	1620		
QN30SP3SPG	Plastic Extreme Back, Glides	1360	1402	1421	1452	1486	1544	1620		
QN30SP3SN	Plastic Extreme Back, Polished Aluminum	1510	1552	1571	1602	1636	1694	1770		
QN30SP3SNG	Plastic Extreme Back, Polished Aluminum, Glides	1510	1552	1571	1602	1636	1694	1770		
QN30SU3SP	Upholstered Back	1473	1522	1544	1581	1620	1687	1777		
QN30SU3SPG	Upholstered Back, Glides	1473	1522	1544	1581	1620	1687	1777		
QN30SU3SN	Upholstered Back, Polished Aluminum	1621	1670	1692	1729	1768	1835	1925		
QN30SU3SNG	Upholstered Back, Polished Aluminum, Glides	1621	1670	1692	1729	1768	1835	1925		

DIMENSIONS

Width	26½	Seat Height	21-28¾	Arm Height	27½-38½	Weight	60
Depth	25¼	Seat Depth	16½	Arm Width	18¼-20½	Cubic Ft.	18.7
Height	42¼-53½	Seat Width	20¼	Back Height	22¼-24¾		
				Back Width	18		

- All height measurements for polished aluminum base models are ½" less than shown above
- Ships fully assembled



Shaded models are available through our Quick Delivery program and will be delivered within 10 days or less. Shaded models that feature the 48 icon will ship within 48 hours (48). See page 6 for additional program information.

TO ORDER, SPECIFY:

1. Model Number
2. Fabric Grade / Cover Number
3. Caster or Glide

- See page 363 for Lavoro options
- See pages 391-393 for COM fabric yardage

**STOOL MID BACK
UPHOLSTERED
STATIC ARMS**



Mobile

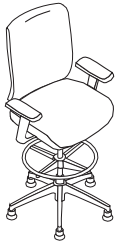

Static



**MODEL
NO.**

GRADE / LIST PRICE

		1	2/COM	3/COL	4	5	6	7	L7	L8
QN30SP9SP	Plastic Extreme Back	\$ 1212	1254	1273	1304	1338	1396	1472		
QN30SP9SPG	Plastic Extreme Back, Glides	1212	1254	1273	1304	1338	1396	1472		
QN30SP9SN	Plastic Extreme Back, Polished Aluminum	1360	1402	1421	1452	1486	1544	1620		
QN30SP9SNG	Plastic Extreme Back, Polished Aluminum, Glides	1360	1402	1421	1452	1486	1544	1620		
QN30SU9SP	Upholstered Back	1323	1372	1394	1431	1470	1537	1627		
QN30SU9SPG	Upholstered Back, Glides	1323	1372	1394	1431	1470	1537	1627		
QN30SU9SN	Upholstered Back, Polished Aluminum	1473	1522	1544	1581	1620	1687	1777		
QN30SU9SNG	Upholstered Back, Polished Aluminum, Glides	1473	1522	1544	1581	1620	1687	1777		

DIMENSIONS

Width	26½	Seat Height	21-28¾	Arm Height	30-38	Weight	60
Depth	25¼	Seat Depth	16½	Arm Width	19½	Cubic Ft.	18.7
Height	42¾-53½	Seat Width	20¼	Back Height	22¼-24¼		
				Back Width	18		

- All height measurements for polished aluminum base models are ½" less than shown above
- Ships fully assembled



Shaded models are available through our Quick Delivery program and will be delivered within 10 days or less. Shaded models that feature the 48 icon will ship within 48 hours (48). See page 6 for additional program information.

TO ORDER, SPECIFY:

1. Model Number
2. Fabric Grade / Cover Number
3. Caster or Glide

• See page 363 for Lavoro options

See pages 391-393 for COM fabric yardage

**STOOL MID BACK
UPHOLSTERED
CONFERENCE ARMS**

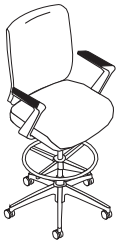

Mobile

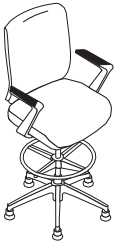

Static



**MODEL
NO.**

GRADE / LIST PRICE

		1	2/COM	3/COL	4	5	6	7	L7	L8
QN30SP8SN	Plastic Extreme Back, Polished Aluminum	\$ 1659	1701	1720	1751	1785	1843	1919		
QN30SP8SNG	Plastic Extreme Back, Polished Aluminum, Glides	1659	1701	1720	1751	1785	1843	1919		
QN30SU8SN	Upholstered Back, Polished Aluminum	1771	1820	1842	1879	1918	1985	2075		
QN30SU8SNG	Upholstered Back, Polished Aluminum, Glides	1771	1820	1842	1879	1918	1985	2075		

DIMENSIONS

Width	26½	Seat Height	21-28¼	Arm Height	29½-37½	Weight	60
Depth	25¼	Seat Depth	16½	Arm Width	20½	Cubic Ft.	18.7
Height	42¼-53	Seat Width	20¼	Back Height	22¼-24¼		
				Back Width	18		

- Ships fully assembled



Shaded models are available through our Quick Delivery program and will be delivered within 10 days or less. Shaded models that feature the 48 icon will ship within 48 hours (48). See page 6 for additional program information.

TO ORDER, SPECIFY:

1. Model Number
2. Mesh Color (when applicable)
3. Fabric Grade / Cover Number
4. Caster or Glide

- See page 363 for Lavoro options
- See pages 391-393 for COM fabric yardage

**GUEST
MESH BACK
ARMLESS**

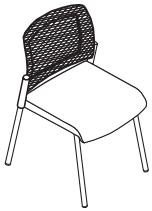

Upholstered Seat Static



Plastic Seat Mobile

**MODEL
NO.**

GRADE / LIST PRICE

		1	2/COM	3/COL	4	5	6	7	L7	L8
QN30GM1PP	Plastic Seat, Static, Black	\$ 674								
QN30GM1PPC	Plastic Seat, Mobile, Black	674								
QN30GM1PN	Plastic Seat, Static, Polished Aluminum	711								
QN30GM1PNC	Plastic Seat, Mobile, Polished Aluminum	711								
QN30GM1UP	Upholstered Seat, Static, Black	748	780	794	817	843	886	943		
QN30GM1UPC	Upholstered Seat, Mobile, Black	748	780	794	817	843	886	943		
QN30GM1UN	Upholstered Seat, Static, Polished Aluminum	785	817	831	854	880	923	980		
QN30GM1UNC	Upholstered Seat, Mobile, Polished Aluminum	785	817	831	854	880	923	980		

DIMENSIONS

Width	21¼	Seat Height	18½	Back Height	16½	Weight	29
Depth	22¼	Seat Depth	17½	Back Width	18	Cubic Ft.	16.7
Height	33	Seat Width	18½				

- For mobile option, add 1" to all heights
- Plastic seat models can stack up to 4 high
- Stacking upholstered seat models is not recommended



Shaded models are available through our Quick Delivery program and will be delivered within 10 days or less. Shaded models that feature the 48 icon will ship within 48 hours (48). See page 6 for additional program information.

TO ORDER, SPECIFY:

1. Model Number
2. Mesh Color (when applicable)
3. Fabric Grade / Cover Number
4. Caster or Glide

• See page 363 for Lavoro options

See pages 391-393 for COM fabric yardage

GUEST MESH BACK ARMS



Upholstered Seat Static



Plastic Seat Mobile

MODEL NO.

GRADE / LIST PRICE

		1	2/COM	3/COL	4	5	6	7	L7	L8
QN30GM9PP	Plastic Seat, Static, Black	\$ 748								
QN30GM9PPC	Plastic Seat, Mobile, Black	748								
QN30GM9PN	Plastic Seat, Static, Polished Aluminum	785								
QN30GM9PNC	Plastic Seat, Mobile, Polished Aluminum	785								
QN30GM9UP	Upholstered Seat, Static, Black	824	856	870	893	919	962	1019		
QN30GM9UPC	Upholstered Seat, Mobile, Black	824	856	870	893	919	962	1019		
QN30GM9UN	Upholstered Seat, Static, Polished Aluminum	859	891	905	928	954	997	1054		
QN30GM9UNC	Upholstered Seat, Mobile, Polished Aluminum	859	891	905	928	954	997	1054		

DIMENSIONS

Width	25¼	Seat Height	18½	Arm Height	27	Weight	29
Depth	22¼	Seat Depth	17½	Arm Width	21½	Cubic Ft.	16.7
Height	33	Seat Width	18½	Back Height	16½		
				Back Width	18		

- For mobile option, add 1" to all heights
- Plastic seat models can stack up to 4 high
- Stacking upholstered seat models is not recommended



Shaded models are available through our Quick Delivery program and will be delivered within 10 days or less. Shaded models that feature the 48 icon will ship within 48 hours (48). See page 6 for additional program information.

TO ORDER, SPECIFY:

1. Model Number
2. Pack
3. Fabric Grade / Cover Number
4. Caster or Glide

- See page 363 for Lavoro options
- See pages 391-393 for COM fabric yardage

**GUEST
UPHOLSTERED BACK
ARMLESS**



Upholstered Seat Static



Plastic Seat Mobile

**MODEL
NO.**

GRADE / LIST PRICE

		1	2/COM	3/COL	4	5	6	7	L7	L8
QN30GP1PP	Plastic Seat, Static, Black	\$ 748	769	779	794	811	840	878		
QN30GP1PPC	Plastic Seat, Mobile, Black	748	769	779	794	811	840	878		
QN30GP1PN	Plastic Seat, Static, Polished Aluminum	785	806	816	831	848	877	915		
QN30GP1PNC	Plastic Seat, Mobile, Polished Aluminum	785	806	816	831	848	877	915		
QN30GP1UP	Upholstered Seat, Static, Black	824	856	870	893	919	962	1019		
QN30GP1UPC	Upholstered Seat, Mobile, Black	824	856	870	893	919	962	1019		
QN30GP1UN	Upholstered Seat, Static, Polished Aluminum	859	891	905	928	954	997	1054		
QN30GP1UNC	Upholstered Seat, Mobile, Polished Aluminum	859	891	905	928	954	997	1054		

DIMENSIONS

Width	21¼	Seat Height	18½	Back Height	16½	Weight	29
Depth	22¼	Seat Depth	17½	Back Width	18	Cubic Ft.	16.7
Height	33	Seat Width	18½				

- For mobile option, add 1" to all heights
- Plastic seat models can stack up to 4 high
- Stacking upholstered seat models is not recommended



Shaded models are available through our Quick Delivery program and will be delivered within 10 days or less. Shaded models that feature the 48 icon will ship within 48 hours (48). See page 6 for additional program information.

TO ORDER, SPECIFY:

1. Model Number
2. Pack
3. Fabric Grade / Cover Number
4. Caster or Glide

• See page 363 for Lavoro options

See pages 391-393 for COM fabric yardage

**GUEST
UPHOLSTERED BACK
ARMS**

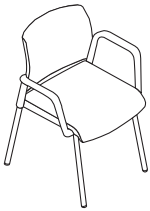

Upholstered Seat Static

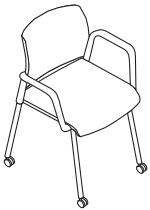

Plastic Seat Mobile

**MODEL
NO.**

GRADE / LIST PRICE

			1	2/COM	3/COL	4	5	6	7	L7	L8
QN30GP9PP	Plastic Seat, Static, Black	\$	824	845	855	870	887	916	954		
QN30GP9PPC	Plastic Seat, Mobile, Black		824	845	855	870	887	916	954		
QN30GP9PN	Plastic Seat, Static, Polished Aluminum		859	880	890	905	922	951	989		
QN30GP9PNC	Plastic Seat, Mobile, Polished Aluminum		859	880	890	905	922	951	989		
QN30GP9UP	Upholstered Seat, Static, Black		897	929	943	966	992	1035	1092		
QN30GP9UPC	Upholstered Seat, Mobile, Black		897	929	943	966	992	1035	1092		
QN30GP9UN	Upholstered Seat, Static, Polished Aluminum		934	966	980	1003	1029	1072	1129		
QN30GP9UNC	Upholstered Seat, Mobile, Polished Aluminum		934	966	980	1003	1029	1072	1129		

DIMENSIONS

Width	25¼	Seat Height	18½	Arm Height	27	Weight	29
Depth	22¼	Seat Depth	17½	Arm Width	21½	Cubic Ft.	16.7
Height	33	Seat Width	18½	Back Height	16½		
				Back Width	18		

- For mobile option, add 1" to all heights
- Plastic seat models can stack up to 4 high
- Stacking upholstered seat models is not recommended



Shaded models are available through our Quick Delivery program and will be delivered within 10 days or less. Shaded models that feature the 48 icon will ship within 48 hours (48). See page 6 for additional program information.

TO ORDER, SPECIFY:

1. Model Number
2. Fabric Grade / Cover Number
3. Caster or Glide

- See page 363 for Lavoro options
- See pages 391-393 for COM fabric yardage

GUEST FULLY UPHOLSTERED BACK ARMLESS

MODEL NO.

GRADE / LIST PRICE

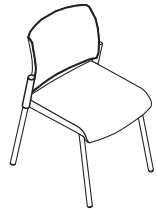

Upholstered Seat Static

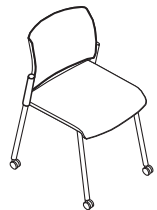

Plastic Seat Mobile

		1	2/COM	3/COL	4	5	6	7	L7	L8
QN30GU1PP	Plastic Seat, Static, Black	\$ 824	845	855	870	887	916	954		
QN30GU1PPC	Plastic Seat, Mobile, Black	824	845	855	870	887	916	954		
QN30GU1PN	Plastic Seat, Static, Polished Aluminum	859	880	890	905	922	951	989		
QN30GU1PNC	Plastic Seat, Mobile, Polished Aluminum	859	880	890	905	922	951	989		
QN30GU1UP	Upholstered Seat, Static, Black	897	929	943	966	992	1035	1092		
QN30GU1UPC	Upholstered Seat, Mobile, Black	897	929	943	966	992	1035	1092		
QN30GU1UN	Upholstered Seat, Static, Polished Aluminum	934	966	980	1003	1029	1072	1129		
QN30GU1UNC	Upholstered Seat, Mobile, Polished Aluminum	934	966	980	1003	1029	1072	1129		

DIMENSIONS

Width	21¼	Seat Height	18½	Back Height	16½	Weight	29
Depth	22¼	Seat Depth	17½	Back Width	18	Cubic Ft.	16.7
Height	33	Seat Width	18½				

- For mobile option, add 1" to all heights
- Plastic seat models can stack up to 4 high
- Stacking upholstered seat models is not recommended



Shaded models are available through our Quick Delivery program and will be delivered within 10 days or less. Shaded models that feature the 48 icon will ship within 48 hours (48). See page 6 for additional program information.

TO ORDER, SPECIFY:

1. Model Number
2. Fabric Grade / Cover Number
3. Caster or Glide

• See page 363 for Lavoro options

See pages 391-393 for COM fabric yardage

GUEST FULLY UPHOLSTERED BACK ARMS

MODEL NO.

GRADE / LIST PRICE



Upholstered Seat Static

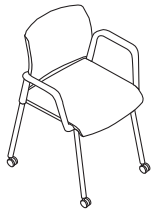

Plastic Seat Mobile

			1	2/COM	3/COL	4	5	6	7	L7	L8
QN30GU9PP	Plastic Seat, Static, Black	\$	897	918	928	943	960	989	1027		
QN30GU9PPC	Plastic Seat, Mobile, Black		897	918	928	943	960	989	1027		
QN30GU9PN	Plastic Seat, Static, Polished Aluminum		934	955	965	980	997	1026	1064		
QN30GU9PNC	Plastic Seat, Mobile, Polished Aluminum		934	955	965	980	997	1026	1064		
QN30GU9UP	Upholstered Seat, Static, Black		972	1004	1018	1041	1067	1110	1167		
QN30GU9UPC	Upholstered Seat, Mobile, Black		972	1004	1018	1041	1067	1110	1167		
QN30GU9UN	Upholstered Seat, Static, Polished Aluminum		1009	1041	1055	1078	1104	1147	1204		
QN30GU9UNC	Upholstered Seat, Mobile, Polished Aluminum		1009	1041	1055	1078	1104	1147	1204		

DIMENSIONS

Width	25¼	Seat Height	18½	Arm Height	27	Weight	29
Depth	22¼	Seat Depth	17½	Arm Width	21½	Cubic Ft.	16.7
Height	33	Seat Width	18½	Back Height	16½		
				Back Width	18		

- For mobile option, add 1" to all heights
- Plastic seat models can stack up to 4 high
- Stacking upholstered seat models is not recommended

MABEL

Product Specifications	396
Fabrics and Options	397
Product Pages	399

MABEL

MABEL PRODUCT SPECIFICATIONS

LOUNGE MODELS

SEAT AND BACK CONSTRUCTION

- ½" molded plywood, cross banded for strength, forms seat and back
- 1¼" of high grade polyurethane foam covers seat and back

BASE AND GLIDES

4-Prong Low and High Profile Polished Aluminum Base

- Polished aluminum control mechanism and cylinder
- Features 360° swivel with auto-return
- Silver polyethylene glides are standard
- Felt pad glides are available for an additional upcharge

4-Prong High Profile Wood Base

- Polished aluminum control mechanism and cylinder
- Features 360° swivel with auto-return
- Maple
- Non-marring nylon glides are standard

4-Leg Wood Base

- Maple
- Non-marring nylon glides are standard

UPHOLSTERY DETAIL

- Contrasting fabric available on all models
- Due to dimensional design of back and seat, horizontal stripes and large patterns are not recommended, as they will appear distorted or wavy
- Due to the inherent characteristics of upholstery materials, loose comfort wrinkles may be present or appear over time

FINISH

- Features a catalyzed top coat that resists denting, peeling, and reactions to chemicals
- Can be cleaned with a damp cloth
- When specifying Brighton, Natural, and Sonoma finish, variation in color is acceptable due to the nature of wood characteristics

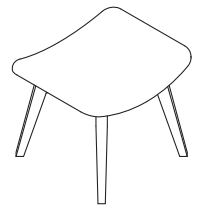
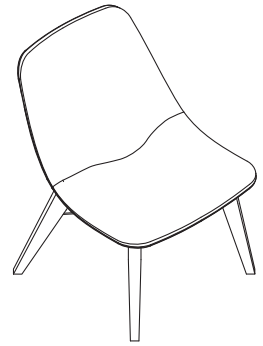

EXECUTIVE CONFERENCE MODELS

SEAT AND BACK CONSTRUCTION

- Injection molded high resistance techno-polymer plastic frame encased with high grade polyurethane foam

ARMS

- Arms are die cast aluminum available in polished aluminum or matte black powder coat

CONTROL MECHANISM

- Synchronous control allows the back and seat to move in a synchronized 2:3:1 ratio motion
- Backrest tilt can be locked in 1 of 3 positions
- Standard pneumatic gas cylinder lift allows seat to raise and lower 5" and provides spring action for added comfort

UPHOLSTERY DETAIL

- Contrasting fabric options available on all models
- Top stitch is offered in matching or contrasting thread colors

FINISH

- Available in polished aluminum or matte black powder coat

BASE AND CASTERS

- 5 prong mobile features height adjustment and 360° swivel
- Available in matte black and polished aluminum
- Black, hard double wheel casters which work on multiple surfaces are standard
- Soft casters are available for an additional upcharge
- Black, open double wheel casters with polished accents are available for additional upcharge and work on multiple floors



FABRICS

Grade 1
 Cali
 Entwine
 Melange
 Ridge
 Spark
 Vessel
 Zig Zag

Grade 2
 Bliss
 Brilliant
 Dolce
 Intuition
 Orbit
 Pixie
 Sedona
 Stencil
 Strand

Grade 3
 Silvertex

Grade 4
 Connect Four
 Echo
 Masquerade

Grade 5
 Mode

Grade 6
 Essence/Ultraleather

Grade 7
 Brisa
 Brisa Distressed
 Reef Pro
 Silica
 Tottori

GLIDES

**LOUNGE
 4-PRONG POLISHED ALUMINUM
 LOW AND HIGH PROFILE BASE**

STD Hard (standard)
 C58 Soft (add \$41 list)



Shaded models are available through our Quick Delivery program and will be delivered within 10 days or less. Shaded models that feature the 48 icon will ship within 48 hours (48). See page 6 for additional program information.

TO ORDER, SPECIFY:

1. Model Number
2. Fabric Grade / Cover Number
3. Glides (when applicable)

- See page 397 for Mabel options
- See page 401 for COM fabric yardage

**4-PRONG
LOW PROFILE
POLISHED ALUMINUM
BASE WITH AUTO RETURN**



Low Back

**MODEL
NO.**

GRADE / LIST PRICE

		1	2/COM	3/COL	4	5	6	7	L7	L8
QN77GL4LM	Low Back	\$ 1794	1861	1891	1940	1994	2085	2206		
QN77GM4LM	Mid Back		1942	2012	2044	2096	2152	2248	2376	

DIMENSIONS

Width	26½	Seat Height	16¼	Back Width	26½	Weight - Low	33
Depth	29¾	Seat Depth	19½	Back Height - Low	19	Cubic Ft. - Low	16.2
Height - Low	31¾	Seat Width	27½	Back Height - Mid	22¾	Weight - Mid	37
Height - Mid	35½			Back Height - High	32¾	Cubic Ft. - Mid	20.3
Height - High	45½					Weight - High	43
						Cubic Ft. - High	27.5

**4-PRONG
HIGH PROFILE
POLISHED ALUMINUM
BASE WITH AUTO RETURN**



Mid Back

		1	2/COM	3/COL	4	5	6	7	L7	L8
QN77GL4HM	Low Back	\$ 1794	1861	1891	1940	1994	2085	2206		
QN77GM4HM	Mid Back		1942	2012	2044	2096	2152	2248	2376	

DIMENSIONS

Width	26½	Seat Height	17¼	Back Width	26½	Weight - Low	33
Depth	29¾	Seat Depth	19½	Back Height - Low	19	Cubic Ft. - Low	12.2
Height - Low	32¾	Seat Width	27½	Back Height - Mid	22¾	Weight - Mid	37
Height - Mid	36½			Back Height - High	33¾	Cubic Ft. - Mid	24.1
Height - High	46½					Weight - High	43
						Cubic Ft. - High	27.5

MABEL



Shaded models are available through our Quick Delivery program and will be delivered within 10 days or less. Shaded models that feature the 48 icon will ship within 48 hours (48). See page 6 for additional program information.

TO ORDER, SPECIFY:

1. Model Number
2. Fabric Grade / Cover Number
3. Glides (when applicable)
4. Thread (when applicable)
5. Casters (when applicable)

- See page 397 for Mabel options
- See page 401 for COM fabric yardage

OTTOMAN 4-PRONG LOW PROFILE SWIVEL BASE



MODEL NO.

GRADE / LIST PRICE

	1	2/COM	3/COL	4	5	6	7	L7	L8
QN77D14LM	\$ 1196	1224	1237	1258	1280	1318	1370		

DIMENSIONS

Width	21							Weight	19.5
Depth	21							Cubic Ft.	8.2
Height	15½								

MIX-IT

Mesh Back Product Specifications	404
Mesh Back Fabrics and Options	405
Mesh Product Pages	406
Upholstered Back Product Specifications	414
Upholstered Back Fabrics and Options	415
Upholstered Back Product Pages	416

MIX-IT MESH BACK PRODUCT SPECIFICATIONS

SEAT CONSTRUCTION

- Recycled plastic inner seat shell designed with a deep ribbing pattern to ensure rigidity
- Seats feature 2½" of custom molded controlled density polyurethane foam for consistency and good contoured support on all models

BACK CONSTRUCTION

- Injection molded inner and outer shell
- Back features ¼" of high grade polyurethane foam on outside edge for support and comfort

MESH

- 100% Polyester
- Cleaning code: W
- 100,000+ double rubs

LUMBAR

- Lumbar can be adjusted approximately 2" by simply lifting and lowering the lumbar pad
- Lumbar pad features 1½" of high grade polyurethane foam for support and comfort

ADJUSTABLE ARMS

- Attached to the seat with metal brackets and screws; encased uprights are made of reinforced nylon
- Adjusts 8 positions in height within a 4" range
- Adjusts 5 positions in width and a 4" range for optimum comfort

STATIC ARMS

- Static arms have twin ⅞" x 16-gauge tubular steel uprights
- Seat and arm mounting components are made of ⅞" x 1" steel plates

HIGH PERFORMANCE ARMS

- Adjusts 10 positions in height within a 4" range
- Width adjustment allows arms to adjust within a 3" range
- Arm pad features depth, width and pivot adjustment
- Encased uprights are made of reinforced nylon

ARM PADS

- Arm pads are soft black polyurethane

CONTROL MECHANISM—SYNCHRONOUS TILT

- Synchronous tilt control allows the back and seat to move in a synchronized 2.3:1 ratio motion
- Free float feature allows the chair to tilt freely
- A side activated telescoping tension adjustment handle provides a comfortable way to adjust back tension to meet individual needs
- The back angle can be locked in 1 of 5 positions
- Standard pneumatic gas cylinder lift allows seat to raise and lower 4¼" and provides spring action for added comfort
- Seat slide option adjusts seat depth within a 2½" range

CONTROL MECHANISM—KNEE TILT

- Standard knee tilt mechanism features heavy-duty adjustable tension spring for a variety of body sizes and minimal rise of front seat edge; this allows the user's feet to remain on the floor when chair is in a reclining position
- The combination gas lift/tilt lock lever allows dual function with simple in/out movement for lockout and up/down movement for height adjustment

LIFT

- Pneumatic gas cylinder lift allows seat to raise and lower 5" and provides spring action for added comfort; finger grip lever adjustment is quick and easy

BASE AND CASTERS

- Black nylon 5-prong base features glass filled nylon for beauty and a long life
- All bases have black, hard double wheel casters, which work on multiple surfaces
- Black, soft double wheel casters are available for use on hard floors; upcharge applies to this option
- Platinum Metallic option models feature a cast aluminum base

GLIDES

- Black nylon ball glides are standard

PAINT

- Metal paint features an electrostatically baked on black textured powder coat or smooth Platinum Metallic; can be cleaned with a damp cloth

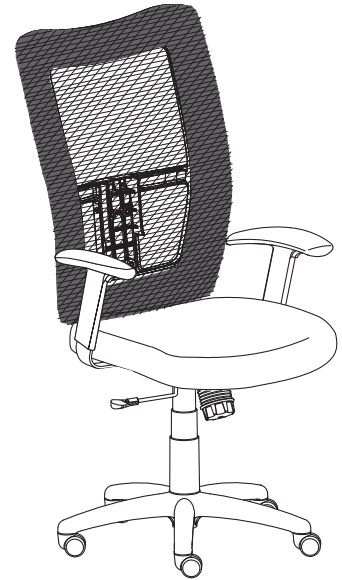

FABRICS

Grade 1
Cali
Entwine
Melange
Ridge
Spark
Vessel
Zig Zag

Grade 2
Bliss
Brilliant
Dolce
Intuition
Orbit
Pixie
Sedona
Stancil
Strand

Grade 3
Silvertex

Grade 4
Connect Four
Echo
Masquerade

Grade 5
Mode

Grade 6
Essence/Ultraleather

Grade 7
Brisa
Brisa Distressed
Reef Pro
Silica
Tottori

CASTERS

FOR BLACK BASE

C15 Hard (standard)
C2 Soft (add \$36 list)



Shaded models are available through our Quick Delivery program and will be delivered within 10 days or less. Shaded models that feature the 48 icon will ship within 48 hours (48). See page 6 for additional program information.

TO ORDER, SPECIFY:

1. Model Number
2. Pack
3. Fabric Grade Number
4. Cover Number
5. Casters

• See page 405 for Mix-it options
See pages 427-428 for COM fabric yardage

**MESH BACK
HEIGHT ADJUSTABLE ARMS
SYNCHRONOUS
PLASTIC BASE**

**MODEL
NO.**

GRADE / LIST PRICE

		1	2/COM	3/COL	4	5	6	7	L7	L8
QN15TMS	Seat Slide	\$ 1453	1485	1499	1522	1548	1591	1648		

DIMENSIONS

Width	26¼	Seat Height	17¼-22¼	Arm Height	25½-34½	Weight	49
Depth	26	Seat Height with		Back Height	23¼	Weight with	
Depth with		Seat Slide	17¼-22¼	Back Width	17¾	Seat Slide	52
Seat Slide	25¼-26½	Seat Depth	17			FA Cubic Ft.	19.1
Height	40¼-45¼	Seat Depth with				KD Cubic Ft.	13.3
Height with		Seat Slide	16½-18¾				
Seat Slide	41¼-46¼	Seat Width	20¼				

• Platinum Metallic option – specify P (i.e., N15TMP) available for a \$208 list upcharge



Height Adjustable Arms



Shaded models are available through our Quick Delivery program and will be delivered within 10 days or less. Shaded models that feature the 48 icon will ship within 48 hours (48). See page 6 for additional program information.

TO ORDER, SPECIFY:

1. Model Number
2. Pack
3. Fabric Grade Number
4. Cover Number
5. Casters

• See page 405 for Mix-it options

See pages 427-428 for COM fabric yardage

**MESH BACK
HEIGHT, WIDTH
ADJUSTABLE ARMS
SYNCHRONOUS
PLASTIC BASE**



Height, Width Adjustable Arms

MODEL NO.

GRADE / LIST PRICE

		1	2/COM	3/COL	4	5	6	7	L7	L8
QN15MMS	Seat Slide	\$ 1522	1554	1568	1591	1617	1660	1717		

DIMENSIONS

Width	26¼-29¼	Seat Height	17½-22½	Arm Height	25½-34½	Weight	49
Depth	26	Seat Height with		Back Height	23¾	Weight with	
Depth with		Seat Slide	17¾-22¾	Back Width	17¾	Seat Slide	52
Seat Slide	25¼-26½	Seat Depth	17			FA Cubic Ft.	19.1
Height	40¾-45¾	Seat Depth with				KD Cubic Ft.	13.3
Height with		Seat Slide	16½-18¾				
Seat Slide	41¼-46¼	Seat Width	20¾				

• Platinum Metallic option – specify P (i.e., N15MMP) available for a \$208 list upcharge

**MESH BACK
HIGH PERFORMANCE ARMS
SYNCHRONOUS
PLASTIC BASE**



High Performance Arms

		1	2/COM	3/COL	4	5	6	7	L7	L8
QN15MMES	Seat Slide	\$ 1695	1727	1741	1764	1790	1833	1890		

DIMENSIONS

Width	26¼-29¼	Seat Height	17½-22½	Arm Height	25½-34½	Weight	49
Depth	26	Seat Height with		Back Height	23¾	Weight with	
Depth with		Seat Slide	17¾-22¾	Back Width	17¾	Seat Slide	52
Seat Slide	25¼-26½	Seat Depth	17			FA Cubic Ft.	19.1
Height	40¾-45¾	Seat Depth with				KD Cubic Ft.	13.3
Height with		Seat Slide	16½-18¾				
Seat Slide	41¼-46¼	Seat Width	20¾				

• Platinum Metallic option – specify P (i.e., N15MMEP) available for a \$208 list upcharge

**MESH BACK
GUEST
POLYURETHANE ARMS**

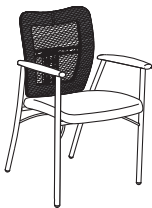

		1	2/COM	3/COL	4	5	6	7	L7	L8
QN15RR		\$ 984	1016	1030	1053	1079	1122	1179		

DIMENSIONS

Width	24¾	Seat Height	18½	Arm Height	26¼	Weight	29
Depth	24	Seat Depth	18¾	Kneespace	20	Cubic Ft.	16.4
Height	36¼	Seat Width	20¾				

• Platinum Metallic option – specify P (i.e., N15RRP) available for a \$54 list upcharge

MIX-IT UPHOLSTERED BACK PRODUCT SPECIFICATIONS

SEAT CONSTRUCTION

- Recycled plastic inner seat shell designed with a deep ribbing pattern to ensure rigidity
- Seats feature 2½" of custom molded controlled density polyurethane foam for consistency and good contoured support on all models

BACK CONSTRUCTION

- Injection molded polypropylene outer shell
- Blow molded polyethylene inner back shell designed with a deep ribbing to ensure rigidity
- Backs feature 1¾" of custom molded, controlled density polyurethane foam for consistency and good contoured support on all models

BACK REST

- Back height can be adjusted by simply lifting up on the back
- Adjusts 6 positions within a range of approximately 2¾"

ADJUSTABLE ARMS

- Attached to the seat with metal brackets and screws; encased uprights are made of reinforced nylon
- Adjusts 8 positions in height within a 4" range
- Adjusts 5 positions in width and a 4" range for optimum comfort

STATIC ARMS

- Static arms have twin ⅞" x 16-gauge tubular steel uprights
- Seat and arm mounting components are made of ⅞" x 1" steel plates

HIGH PERFORMANCE ARMS

- Adjusts 10 positions in height within a 4" range
- Width adjustment allows arms to adjust within a 3" range
- Arm pad features depth, width and pivot adjustment
- Encased uprights are made of reinforced nylon

ARM PADS

- Arm pads are soft black polyurethane

CONTROL MECHANISM—SYNCHRONOUS TILT

- Synchronous tilt control allows the back and seat to move in a synchronized 2.3:1 ratio motion
- Free float feature allows the chair to tilt freely
- A side activated telescoping tension adjustment handle provides a comfortable way to adjust back tension to meet individual needs
- The back angle can be locked in 1 of 5 positions
- Standard pneumatic gas cylinder lift allows seat to raise and lower 4¼" and provides spring action for added comfort
- Seat slide option adjusts seat depth within a 2½" range

CONTROL MECHANISM—KNEE TILT

- Standard knee tilt mechanism features heavy-duty adjustable tension spring for a variety of body sizes and minimal rise of front seat edge; this allows the user's feet to remain on the floor when chair is in a reclining position
- The combination gas lift/tilt lock lever allows dual function with simple in/out movement for lockout and up/down movement for height adjustment

LIFT

- Pneumatic gas cylinder lift allows seat to raise and lower 5" and provides spring action for added comfort; finger grip lever adjustment is quick and easy

BASE AND CASTERS

- Black nylon 5-prong base features glass filled nylon for beauty and a long life
- All bases have black, hard double wheel casters, which work on multiple surfaces
- Black, soft double wheel casters are available for use on hard floors; upcharge applies to this option
- Platinum Metallic option models feature a cast aluminum base

GLIDES

- Black nylon ball glides are standard
- For rough textured or soft surface flooring, we recommend using soft glides, contact customer service for pricing and availability

PAINT

- Metal paint features an electrostatically baked on black textured powder coat or smooth Platinum Metallic; can be cleaned with a damp cloth

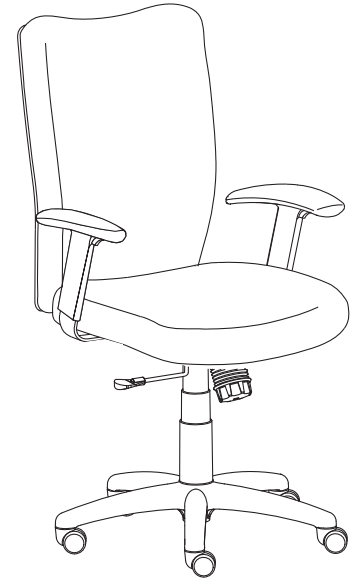

All Mix-it upholstered back models may be ordered to meet TB133 fire code.

To order seating to meet the TB133 fire code, specify an "F" at the end of the model number (Ex: N12CCYF).

For TB133 pricing go to www.NationalOfficeFurniture.com/TB133

Please consult customer service for applicable Arc-Com, Carnegie, DesignTex, Maharam, Mayer, Momentum, Stinson, or Ultrafabrics fabric.

FABRICS

Grade 1
 Cali
 Entwine
 Melange
 Ridge
 Spark
 Vessel
 Zig Zag

Grade 2
 Bliss
 Brilliant
 Dolce
 Intuition
 Orbit
 Pixie
 Sedona
 Stencil
 Strand*

Grade 3
 Silvertex

Grade 4
 Connect Four
 Echo
 Masquerade

Grade 5
 Mode

Grade 6
 Essence/Ultraleather

Grade 7
 Brisa
 Brisa Distressed
 Reef Pro
 Silica
 Tottori

*Strand restricted on upholstered back models

CASTERS

FOR BLACK BASE

C15 Hard (standard)
 C2 Soft (add \$36 list)



Shaded models are available through our Quick Delivery program and will be delivered within 10 days or less. Shaded models that feature the 48 icon will ship within 48 hours (48). See page 6 for additional program information.

TO ORDER, SPECIFY:

1. Model Number
2. Pack
3. Fabric Grade Number
4. Cover Number
5. Casters

• See page 415 for Mix-it options

See pages 427-428 for COM fabric yardage

**MID BACK
HEIGHT ADJUSTABLE ARMS
SYNCHRONOUS
PLASTIC BASE**



Height Adjustable Arms

MODEL NO.

GRADE / LIST PRICE

		1	2/COM	3/COL	4	5	6	7	L7	L8
QN12TJC	Plastic Back	\$ 1463	1505	1524	1555	1589	1647	1723		
QN12TJCS	Plastic Back/Seat Slide	1613	1655	1674	1705	1739	1797	1873		

DIMENSIONS

Width	26¼-29¼	Seat Height	17¼-22¼	Arm Height	26-34	Weight	55.8
Depth	26	Seat Height with		Back Height	19-21½	Weight with	
Depth with		Seat Slide	17¼-22¼	Back Width	18	Seat Slide	59.4
Seat Slide	25¼-26½	Seat Depth	16¾			FA Cubic Ft.	18.3
Height	35½-43½	Seat Depth with				KD Cubic Ft.	13.3
Height with		Seat Slide	16½-18¾				
Seat Slide	36¼-44¼	Seat Width	20¼				

• Platinum Metallic option – specify P (i.e., N12TJCP) available for a \$208 list upcharge



Shaded models are available through our Quick Delivery program and will be delivered within 10 days or less. Shaded models that feature the 48 icon will ship within 48 hours (48). See page 6 for additional program information.

TO ORDER, SPECIFY:

1. Model Number
2. Pack
3. Fabric Grade Number
4. Cover Number
5. Casters

• See page 415 for Mix-it options
See pages 427-428 for COM fabric yardage

**MID BACK
HEIGHT, WIDTH
ADJUSTABLE ARMS
SYNCHRONOUS
PLASTIC BASE**



Height, Width Adjustable Arms

MODEL NO.	GRADE / LIST PRICE										
		1	2/COM	3/COL	4	5	6	7	L7	L8	
QN12JJC	Plastic Back	\$ 1505	1547	1566	1597	1631	1689	1765			
QN12JCS	Plastic Back/Seat Slide	1651	1693	1712	1743	1777	1835	1911			

DIMENSIONS

Width	26¼-29¼	Seat Height	17¼-22¼	Arm Height	26-34	Weight	55.8
Depth	26	Seat Height with		Back Height	19-21½	Weight with	
Depth with		Seat Slide	17¼-22¼	Back Width	18	Seat Slide	59.4
Seat Slide	25¼-26½	Seat Depth	16¾			FA Cubic Ft.	18.3
Height	35½-43½	Seat Depth with				KD Cubic Ft.	13.3
Height with		Seat Slide	16½-18¾				
Seat Slide	36¼-44¼	Seat Width	20¼				

• Platinum Metallic option – specify P (i.e., N12JJCP) available for a \$208 list upcharge

**MID BACK
HIGH PERFORMANCE ARMS
SYNCHRONOUS
PLASTIC BASE**



High Performance Arms

MODEL NO.	GRADE / LIST PRICE										
		1	2/COM	3/COL	4	5	6	7	L7	L8	
QN12JJCE	Plastic Back	\$ 1677	1719	1738	1769	1803	1861	1937			
QN12JJCES	Plastic Back/Seat Slide	1828	1870	1889	1920	1954	2012	2088			

DIMENSIONS

Width	26¼-29¼	Seat Height	17¼-22¼	Arm Height	25½-34½	Weight	55.8
Depth	26	Seat Height with		Back Height	19-21½	Weight with	
Depth with		Seat Slide	17¼-22¼	Back Width	18	Seat Slide	59.4
Seat Slide	25¼-26½	Seat Depth	16¾			FA Cubic Ft.	18.3
Height	35½-43½	Seat Depth with				KD Cubic Ft.	13.3
Height with		Seat Slide	16½-18¾				
Seat Slide	36¼-44¼	Seat Width	20¼				

• Platinum Metallic option – specify P (i.e., N12JJCEP) available for a \$208 list upcharge



Shaded models are available through our Quick Delivery program and will be delivered within 10 days or less. Shaded models that feature the 48 icon will ship within 48 hours (48). See page 6 for additional program information.

TO ORDER, SPECIFY:

1. Model Number
2. Pack
3. Fabric Grade Number
4. Cover Number
5. Casters

• See page 415 for Mix-it options
See pages 427-428 for COM fabric yardage

**HIGH BACK
HEIGHT ADJUSTABLE ARMS
SYNCHRONOUS
PLASTIC BASE**



Height Adjustable Arms

MODEL NO.

GRADE / LIST PRICE

		1	2/COM	3/COL	4	5	6	7	L7	L8
QN12TMCS	Plastic Back/Seat Slide	\$ 1655	1701	1721	1755	1792	1854	1937		

DIMENSIONS

Width	26¼	Seat Height	17¼-22¼	Arm Height	27¼-32¼	Weight	63.5
Depth	26	Seat Height with		Back Height	22-24½	Weight with	
Depth with		Seat Slide	17¼-22¼	Back Width	18½	Seat Slide	67.1
Seat Slide	25¼-26½	Seat Depth	16¼			FA Cubic Ft.	19.1
Height	39¼-47¼	Seat Depth with				KD Cubic Ft.	13.3
Height with		Seat Slide	16½-18¼				
Seat Slide	40-48	Seat Width	20¼				

• Platinum Metallic option – specify P (i.e., N12TMCP) available for a \$208 list upcharge



Shaded models are available through our Quick Delivery program and will be delivered within 10 days or less. Shaded models that feature the 48 icon will ship within 48 hours (48). See page 6 for additional program information.

TO ORDER, SPECIFY:

1. Model Number
2. Pack
3. Fabric Grade Number
4. Cover Number
5. Casters

• See page 415 for Mix-it options
See pages 427-428 for COM fabric yardage

**HIGH BACK
HEIGHT, WIDTH
ADJUSTABLE ARMS
SYNCHRONOUS
PLASTIC BASE**



Height, Width Adjustable Arms

MODEL NO.	GRADE / LIST PRICE									
		1	2/COM	3/COL	4	5	6	7	L7	L8
QN12MMCS	Plastic Back/Seat Slide	\$ 1695	1741	1761	1795	1832	1894	1977		

DIMENSIONS

Width	26¼-29¼	Seat Height	17¼-22¼	Arm Height	26-34	Weight	61.3
Depth	26	Seat Height with		Back Height	22-24½	Weight with	
Depth with		Seat Slide	17¼-22¼	Back Width	18½	Seat Slide	64.9
Seat Slide	25¼-26½	Seat Depth	16¼			FA Cubic Ft.	19.1
Height	39¼-47¼	Seat Depth with				KD Cubic Ft.	13.3
Height with		Seat Slide	16½-18¾				
Seat Slide	40-48	Seat Width	20¼				

• Platinum Metallic option – specify P (i.e., N12MMCP) available for a \$208 list upcharge

**HIGH BACK
HIGH PERFORMANCE ARMS
SYNCHRONOUS
PLASTIC BASE**



High Performance Arms

MODEL NO.	GRADE / LIST PRICE									
		1	2/COM	3/COL	4	5	6	7	L7	L8
QN12MMCES	Plastic Back/Seat Slide	\$ 1868	1914	1934	1968	2005	2067	2150		

DIMENSIONS

Width	26¼-29¼	Seat Height	17¼-22¼	Arm Height	25½-34½	Weight	61.3
Depth	26	Seat Height with		Back Height	22-24½	Weight with	
Depth with		Seat Slide	17¼-22¼	Back Width	18½	Seat Slide	64.9
Seat Slide	25¼-26½	Seat Depth	16¼			FA Cubic Ft.	19.1
Height	39¼-47¼	Seat Depth with				KD Cubic Ft.	13.3
Height with		Seat Slide	16½-18¾				
Seat Slide	40-48	Seat Width	20¼				

• Platinum Metallic option – specify P (i.e., N12MMCEP) available for a \$208 list upcharge

**GUEST
POLYURETHANE ARMS**

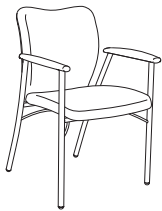

MODEL NO.	GRADE / LIST PRICE									
		1	2/COM	3/COL	4	5	6	7	L7	L8
QN12RR	Plastic Back	\$ 939	978	995	1024	1055	1107	1178		
QN12QQ	Upholstered Back	984	1033	1055	1092	1131	1198	1288		

DIMENSIONS

Width	24¼	Seat Height	18½	Arm Height	26¼	Weight	40
Depth	24	Seat Depth	18¼	Kneespace	20	Cubic Ft.	16.4
Height	34¼	Seat Width	20¼				

• Platinum Metallic option – specify P (i.e., N12RRP) available for a \$54 list upcharge

MONTERREY

Product Specifications	430
Fabrics and Options	431
Product Pages	433

MONTERREY

MONTERREY PRODUCT SPECIFICATIONS

FRAME CONSTRUCTION

- Interior frame is constructed of plywood with tenon joints that are glued and screwed for maximum joint stability
- Seat joints are supported by corner blocks
- Non-marring nylon glides

SEAT CONSTRUCTION

- Seat cushion is removable and features 5" of high grade polyurethane foam, which is custom shaped and fabricated and placed on high tension strip webbing
- Seat cushion is secured with fastener clips on 2 and 3 seat lounge models

BACK CONSTRUCTION

- 2½" of high grade polyurethane foam, which is custom shaped and stretched over web sheet and attached to frame

ARM CONSTRUCTION

- Armrest frames are wrapped with 1" of high grade polyurethane foam

UPHOLSTERY DETAIL

- Available with contrasting fabric or contrasting piping
- Welt cord framing referred to as piping
- Tufted models available and feature ¾" round buttons

FINISH

- A catalyzed top coat resists denting, peeling, and reactions to chemicals
- Can be cleaned with a damp cloth
- When specifying Brighton, Natural, and Sonoma finish, variation in color is acceptable due to the nature of wood characteristics

WOOD SPECIES

- Exposed wood base is constructed from soft maple

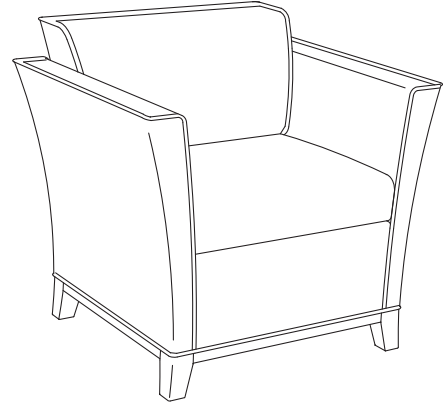

All Monterrey models may be ordered to meet TB133 fire code.

To order seating to meet the TB133 fire code, specify an "F" at the end of the model number (Ex: N90AAF).

For TB133 pricing go to www.NationalOfficeFurniture.com/TB133

Please consult customer service for applicable Arc-Com, Carnegie, Designtex, Maharam, Mayer, Momentum, Stinson, or Ultrafabrics fabric.

FABRICS

Grade 1	Cali
	Entwine
	Melange
	Ridge
	Spark
	Vessel
	Zig Zag

Grade 2	Bliss
	Brilliant
	Dolce
	Intuition
	Orbit
	Pixie
	Sedona
	Stancil
	Strand

Grade 3	Silvertex
---------	-----------

Grade 4	Connect Four
	Echo
	Masquerade

Grade 5	Mode
---------	------

Grade 6	Essence/Ultraleather
---------	----------------------

Grade 7	Brisa
	Brisa Distressed
	Reef Pro
	Silica
	Tottori

FINISHES

AC	Autumn	NM	Natural
AD	Almond	PB	Portobello
BZ	Brazilwood	PC	Porcini
CI	Chai	PT	Portico
CL	Caramel	SK	Skyline
CW	Cordovan	SM	Sonoma
DW	Judicial	TF	Truffle
HN	Honey	WL	Willow
IM	Brighton	405	Designer White
KN	Kona	462	Cinder
MC	Amber	792	Sable
MH	Mocha	793	Acorn*

*Acorn is the finish complement to Clear Walnut finish



Shaded models are available through our Quick Delivery program and will be delivered within 10 days or less. Shaded models that feature the 48 icon will ship within 48 hours (48). See page 6 for additional program information.

TO ORDER, SPECIFY:

1. Model Number
2. Fabric Grade Number
3. Cover Number
4. Finish Designator

• See page 431 for Monterrey options
See page 435 for COM fabric yardage

1 SEAT LOUNGE



Tufted

MODEL NO.

QN90AA Non-Tufted

GRADE / LIST PRICE

	1	2/COM	3/COL	4	5	6	7	L7	L8
QN90AA Non-Tufted	\$ 3012	3180	3257	3382	3516	3746	4054		

DIMENSIONS

Width	34½	Seat Width	22	Arm Height	27¾	Weight	90
Depth	30¼	Seat Depth	21			Cubic Ft.	27.0
Height	31¼	Seat Height	19½				

RALLA

Product Specifications	438
Fabrics and Options	439
Product Pages	440

RALLA

RALLA PRODUCT SPECIFICATIONS

SEAT CONSTRUCTION

- Upholstered seat cushion
- High grade polyurethane foam covers a plywood seat panel

BASE AND CASTERS

- Black 5-star plastic base
- Hard, dual wheel casters: black
- Optional soft, dual wheel casters for use on hard floors; black; available for an upcharge
- Black footring available on applicable model

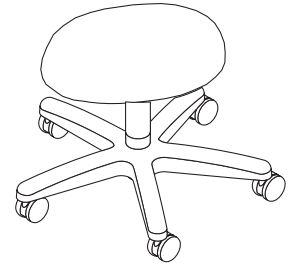

FABRICS

Grade 1 Cali
 Entwine
 Melange
 Ridge
 Spark
 Vessel
 Zig Zag

Grade 2 Bliss
 Brilliant
 Dolce
 Intuition
 Orbit
 Pixie
 Sedona
 Stencil
 Strand

Grade 3 Silvertex

Grade 4 Connect Four
 Echo
 Masquerade

Grade 5 Mode

Grade 6 Essence/Ultraleather

Grade 7 Brisa
 Brisa Distressed
 Reef Pro
 Silica
 Tottori

CASTERS

C3 Hard (standard)
 C4 Soft (add \$36 list)

RALLA



Shaded models are available through our Quick Delivery program and will be delivered within 10 days or less. Shaded models that feature the 48 icon will ship within 48 hours (48). See page 6 for additional program information.

TO ORDER, SPECIFY:

1. Model Number
2. Fabric Grade / Cover Number
3. Caster

- See page 439 for Ralla options
- See page 441 for COM fabric yardage

TASK STOOL



MODEL NO.

GRADE / LIST PRICE

	1	2/COM	3/COL	4	5	6	7	L7	L8
QN61PES	\$ 481	506	517	535	555	588	633		

DIMENSIONS

Width	23½	Seat Diameter	14½	Cushion Thickness	2¾	Weight	16.6
Height	16¾-21¾					Cubic Ft.	7.3

TASK STOOL WITH FOOTRING



	1	2/COM	3/COL	4	5	6	7	L7	L8
QN61PESR With Footring	\$ 589	614	625	643	663	696	741		

DIMENSIONS

Width	23¾	Seat Diameter	14½	Cushion Thickness	2¾	Weight	18.6
Height	16¾-21¾	Footring Diameter	18			Cubic Ft.	7.3

RALLA

RENO

Product Specifications	444
Fabrics and Options	445
Product Pages	447

RENO PRODUCT SPECIFICATIONS

FRAME CONSTRUCTION

- Interior frame is constructed of plywood with tenon joints that are glued and screwed for maximum joint stability
- Seat joints are supported by corner blocks with high tensile screws
- Reno Slim models feature a reduced footprint – see model dimensions for details

SEAT CONSTRUCTION

- Seat cushions are attached and feature 6" of high grade polyurethane foam, which is custom shaped and fabricated, and placed on high tension strip webbing

BACK CONSTRUCTION

- 5" of high grade polyurethane foam, which is custom shaped and stretched over web sheet and attached to frame

ARM CONSTRUCTION

- Armrest frames are wrapped with high grade polyurethane foam and slipcovered
- The frame is attached to the unit with 3 bolts per arm

WOOD ARM CONSTRUCTION

- Arms are molded of linear laminated hard maple veneers

CUP HOLDER

- Available on standard Reno upholstered arm

CONTRASTING FABRICS

- Available with 3 contrasting fabric locations: back, seat, and arms

LEGS

- Die-cast zinc legs are Platinum Metallic plated, Satin Nickel Metallic plated or Cinder powder coat paint and have nylon glides
- Wood legs are constructed of maple with nylon glides
- When specifying Brighton, Natural, and Sonoma finish, variation in color is acceptable due to the nature of wood characteristics

HANDLE AND CASTERS N32BB AND N32DD

- Handle featured on mobile lounge is die-cast zinc that is Platinum Metallic plated, Satin Nickel Metallic plated or Cinder powder coat paint
- Heavy-duty black double wheel casters

TABLET ARM

- ¾" thick black 3D Laminate with MDF core or ¾" thick maple
- Attached with ¼" steel base plate and screws that mounts over ¾" metal insert rod and fits into structure of arm
- Tablet height is 28" from floor to top of tablet surface
- Allows for 360° swivel and writing surface of 21" W x 13½" D

BENCHES

- 8" of foam covers a ½" plywood panel on top of fiberboard frame
- Black, double wheel, roll control casters are standard and work on all floors

POWER GROMMET

- G23 black or silver grommet is available in right, left or both sides of the back for an additional upcharge
- Features 2 electrical receptacles and 2 power USB ports

TABLES

- Grade A slipmatched maple (Brighton, Caramel, Honey, Natural), or cherry veneer (Amber, Autumn, Cordovan, Judicial, Mocha, Truffle) or laminate
- All Veneer surfaces feature a semi-open poor matte finish
- Die-cast zinc legs with nylon glides
- 3 power grommets available; specify cutout option and order electrical grommet model separately. See pages 645-646 for details and pricing
- Optional glass and solid surface kits available; reference the Tables Price List

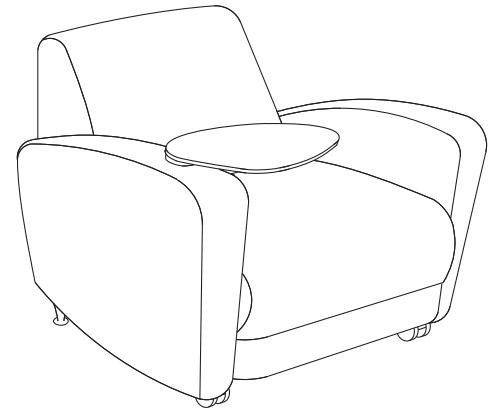

All Reno models may be ordered to meet TB133 fire code.

To order seating to meet the TB133 fire code, specify an "F" at the end of the model number (Ex: N32AAMF).

For TB133 pricing go to www.NationalOfficeFurniture.com/TB133

Please consult customer service for applicable Arc-Com, Carnegie, DesignTex, Maharam, Mayer, Momentum, Stinson, or Ultrafabrics fabric.

FABRICS

Grade 1	Cali Entwine Melange Ridge Spark Vessel Zig Zag
---------	---

Grade 2	Bliss Brilliant Dolce Intuition Orbit Pixie Sedona Stencil Strand
---------	---

Grade 3	Silvertex
---------	-----------

Grade 4	Connect Four Echo Masquerade
---------	------------------------------------

Grade 5	Mode
---------	------

Grade 6	Essence/Ultraleather
---------	----------------------

Grade 7	Brisa Brisa Distressed Reef Pro Silica Tottori
---------	--

**FINISHES
(WOOD ARMS, LEGS AND
TABLES)**

AC	Autumn	NM	Natural
AD	Almond*	PB	Portobello*
BZ	Brazilwood	PC	Porcini
CI	Chai	PT	Portico*
CL	Caramel	SK	Skyline*
CW	Cordovan	SM	Sonoma*
DW	Judicial	TF	Truffle
HN	Honey	WL	Willow
IM	Brighton	405	Designer White*
KN	Kona	462	Cinder*
MC	Amber	792	Sable*
MH	Mocha	793	Acorn*†

*Not available on tables

†Acorn is the finish and laminate complement to Clear Walnut finish

**PAINT COLORS
(LEGS AND HANDLE)**

423	Concrete
462	Cinder
463	Iron
501	Platinum Metallic
503	Satin Nickel Metallic



Shaded models are available through our Quick Delivery program and will be delivered within 10 days or less. Shaded models that feature the 48 icon will ship within 48 hours (48). See page 6 for additional program information.

TO ORDER, SPECIFY:

1. Model Number
2. Fabric Grade / Cover Number
3. Power Grommet
4. Cup Holder
5. Tablet and Finish (when applicable)
6. Paint (when applicable)
7. Wood Leg Finish (when applicable)

• See page 445 for Reno options
See pages 458-459 for COM fabric yardage

1 SEAT LOUNGE

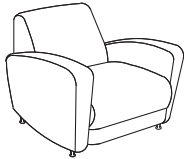

Metal Legs

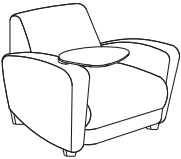

Wood Legs

MODEL NO.

GRADE / LIST PRICE

		1	2/COM	3/COL	4	5	6	7	L7	L8
QN32AAM	Metal Legs	\$ 2315	2487	2565	2692	2830	3065	3378		
QN32AAW	Wood Legs	2486	2658	2736	2863	3001	3236	3549		

DIMENSIONS

Width	34½	Arm Height	27	Seat Width	22	Weight	83
Depth	34½	Seat Height	19			Tablet Weight	95
Height	33	Seat Depth	21¼			Cubic Ft.	32



RESPECT

Product Specifications	462
Fabrics and Options	463
Product Pages	464



RESPECT

RESPECT PRODUCT SPECIFICATIONS

FRAME CONSTRUCTION

GUEST MODEL

- Frame constructed of exterior beech with joints double doweled and glued for maximum joint stability
- Features a metal seat understructure for added strength

SEAT AND BACK CONSTRUCTION

HIGH AND MID BACK MODELS

- 2½" of high grade polyurethane foam covers seat
- 7-ply inner, 1 piece molded plywood shell forms seat and back
- High back model consists of 1½" of high grade polyurethane foam on the lower back and 2½" on the upper back
- Mid back model consists of 1½" of high grade polyurethane foam on the back

GUEST MODEL

- 2" of high grade polyurethane foam covers a solid plywood seat panel
- 1" of high grade polyurethane foam covers a solid plywood back panel

CONTROL MECHANISM/LIFT

- The standard knee tilt mechanism features a heavy-duty adjustment tension spring for a variety of body sizes and minimal rise of front seat edge. This allows the user's feet to remain on the floor when chair is in reclining position
- The combination gas lift/tilt lock lever allows dual function with simple in/out movement for lockout and up/down movement for height adjustment

BASE AND CASTERS

- Wood base features a standard 5-prong, rigid steel understructure to ensure long life
- Black and powder coated Satin Nickel Metallic bases feature reinforced nylon
- Black, hard double wheel casters, which work on multiple surfaces, are standard
- Black, soft double wheel casters are available for use on hard floors; upcharge applies to this option

ARMS

- Arms constructed of reinforced nylon available in black or powder coated Satin Nickel Metallic finish
- Arms are attached to seat and back with screws
- Arm pads are soft black polyurethane

UPHOLSTERY

- Gathering may result in upholstery due to the pillow back design

FINISH

- Wood models feature a catalyzed top coat that resists denting, peeling, and reactions to chemicals
- Can be cleaned with a damp cloth
- When specifying Brighton, Natural, and Sonoma finish, variation in color is acceptable due to the nature of wood characteristics

WOOD SPECIES

- Beech

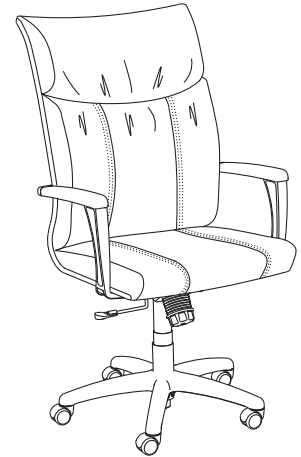

All Respect models may be ordered to meet TB133 fire code.

To order seating to meet the TB133 fire code, specify an "F" at the end of the model number (Ex: N75BACF).

For TB133 pricing go to www.NationalOfficeFurniture.com/TB133

Please consult customer service for applicable Arc-Com, Carnegie, Designtex, Maharam, Mayer, Momentum, Stinson, or Ultrafabrics fabric.

FABRICS

Grade 1	Cali Entwine Melange Ridge Spark Vessel Zig Zag
---------	---

Grade 2	Bliss Brilliant Dolce Intuition Orbit Pixie Sedona Stencil Strand
---------	---

Grade 3	Silvertex
---------	-----------

Grade 4	Connect Four Echo Masquerade
---------	------------------------------------

Grade 5	Mode
---------	------

Grade 6	Essence/Ultraleather
---------	----------------------

Grade 7	Brisa Brisa Distressed Reef Pro Silica Tottori
---------	--

FINISHES

AC	Autumn	NM	Natural
AD	Almond	PB	Portobello
BZ	Brazilwood	PC	Porcini
CI	Chai	PT	Portico
CL	Caramel	SK	Skyline
CW	Cordovan	SM	Sonoma
DW	Judicial	TF	Truffle
HN	Honey	WL	Willow
IM	Brighton	405	Designer White
KN	Kona	462	Cinder
MC	Amber	792	Sable
MH	Mocha	793	Acorn*

*Acorn is the finish complement to Clear Walnut finish

CASTERS

FOR PLASTIC BASE

C15	Hard (standard)
C2	Soft (add \$36 list)

RESPECT



Shaded models are available through our Quick Delivery program and will be delivered within 10 days or less. Shaded models that feature the 48 icon will ship within 48 hours (48). See page 6 for additional program information.

TO ORDER, SPECIFY:

1. Model Number
2. Fabric Grade Number
3. Cover Number
4. Finish Designator
5. Casters

- See page 463 for Respect options
- See page 466 for COM fabric yardage

HIGH BACK PLASTIC BASE



All Covers

MODEL NO.

GRADE / LIST PRICE

			1	2/COM	3/COL	4	5	6	7	L7	L8
QN75BAC	Black Arms/Black Base	\$	1440	1521	1557	1617	1682	1792	1939		

DIMENSIONS

Width	26½	Arm Height	26-31¼	Seat Width	22¼	Weight	40
Depth	27¾	Seat Height	16½-21¾			Cubic Ft.	20.4
Height	43¾-48½	Seat Depth	17½				

- Gathering may result in upholstery due to the pillow back design

MID BACK PLASTIC BASE



Leathers and Vinyls

			1	2/COM	3/COL	4	5	6	7	L7	L8
QN75BCC	Black Arms/Black Base	\$	1397	1474	1509	1566	1628	1734	1874		

DIMENSIONS

Width	26½	Arm Height	26½-31½	Seat Width	22¼	Weight	39
Depth	26¾	Seat Height	17¼-22¾			Cubic Ft.	19.3
Height	39¾-44¾	Seat Depth	16¾				

- Gathering may result in upholstery due to the pillow back design



All Fabrics



Shaded models are available through our Quick Delivery program and will be delivered within 10 days or less. Shaded models that feature the 48 icon will ship within 48 hours (48). See page 6 for additional program information.

TO ORDER, SPECIFY:

1. Model Number
2. Fabric Grade Number
3. Cover Number
4. Finish Designator
5. Casters

- See page 463 for Respect options
- See page 466 for COM fabric yardage

GUEST

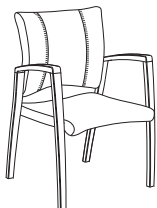

All Covers

MODEL NO.

GRADE / LIST PRICE

		1	2/COM	3/COL	4	5	6	7	L7	L8
QN75WS	Wood Frame	\$ 1131	1177	1197	1231	1268	1330	1413		

DIMENSIONS

Width	24¾	Arm Height	27¼	Seat Width	20½	Weight	19
Depth	22¾	Seat Height	18			Cubic Ft.	15.3
Height	34¾	Seat Depth	16½				

- Gathering may result in upholstery due to the pillow back design

RIZORA

Product Specifications	468
Fabrics and Options	469
Product Pages	470

RIZORA

RIZORA PRODUCT SPECIFICATIONS

FRAME CONSTRUCTION

- Injection molded polypropylene seat
- Beech wood legs
- Polished metal footrest

FINISH

- Wood legs are available in all National standard finishes
- When specifying Brighton, Natural, and Sonoma finish, variation in color is acceptable due to the nature of beech wood characteristics

UPHOLSTERED SEAT PAD

- Wood seat panel
- Polyurethane foam

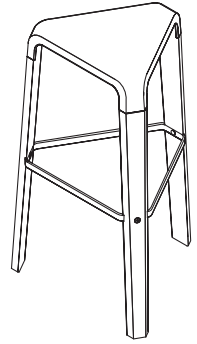

All Rizora models that do not feature an upholstered seat pad meet TB133 fire code. For TB133 availability on models with an upholstered seat pad, please contact customer service.

FABRICS

Grade 1	Cali Entwine Melange Ridge Spark Vessel Zig Zag
---------	---

Grade 2	Bliss Brilliant Dolce Intuition Orbit Pixie Sedona Stancil Strand
---------	---

Grade 3	Silvertex
---------	-----------

Grade 4	Connect Four Echo Masquerade
---------	------------------------------------

Grade 5	Mode
---------	------

Grade 6	Essence/Ultraleather
---------	----------------------

Grade 7	Brisa Brisa Distressed Reef Pro Silica Tottori
---------	--

SEAT COLORS

BG	Burgundy
BK	Black
DG	Dark Grey
LG	Light Grey
NV	Navy
TP	Taupe
WH	White

WOOD LEG FINISHES

AC	Autumn	NM	Natural
AD	Almond	PB	Portobello
BZ	Brazilwood	PC	Porcini
CI	Chai	PT	Portico
CL	Caramel	SK	Skyline
CW	Cordovan	SM	Sonoma
DW	Judicial	TF	Truffle
HN	Honey	WL	Willow
IM	Brighton	405	Designer White
KN	Kona	462	Cinder
MC	Amber	792	Sable
MH	Mocha	793	Acorn*

*Acorn is the finish complement to Clear Walnut finish

RIZORA



Shaded models are available through our Quick Delivery program and will be delivered within 10 days or less. Shaded models that feature the 48 icon will ship within 48 hours (48). See page 6 for additional program information.

TO ORDER, SPECIFY:

1. Model Number
2. Plastic Seat Color
3. Fabric Grade / Cover Number (when applicable)
4. Wood Leg Finish

• See page 469 for Rizora options
See page 472 for COM fabric yardage

GUEST STOOL



Upholstered Seat Pad

MODEL NO.

GRADE / LIST PRICE

QN40G1	Package of 1	\$ 740										
QN40G2	Package of 2	1437										

		1	2/COM	3/COL	4	5	6	7	L7	L8
QN40GU1	Upholstered Seat Pad, Package of 1	\$ 849	867	875	888	902	926	958		
QN40GU2	Upholstered Seat Pad, Package of 2	1652	1670	1678	1691	1705	1729	1761		

DIMENSIONS

Width	17½	Seat Height	18	Weight (1)	10.8
Depth	15¾	Seat Depth	13¾	Cubic Ft. (1)	3.3
Height	18	Seat Width	15½	Weight (2)	19.6
				Cubic Ft. (2)	3.9

• For the upholstered seat pad models, add ¾" to all height dimensions and 1 lb. to weight per unit

COUNTER HEIGHT STOOL



Upholstered Seat Pad

QN40C1	Package of 1	\$ 776								
QN40C2	Package of 2	1509								

		1	2/COM	3/COL	4	5	6	7	L7	L8
QN40CU1	Upholstered Seat Pad, Package of 1	\$ 884	902	910	923	937	961	993		
QN40CU2	Upholstered Seat Pad, Package of 2	1724	1742	1750	1763	1777	1801	1833		

DIMENSIONS

Width	18	Seat Height	24	Weight (1)	12.9
Depth	15¾	Seat Depth	13¾	Cubic Ft. (1)	4.6
Height	24	Seat Width	15½	Weight (2)	22.8
				Cubic Ft. (2)	6.6

• For the upholstered seat pad models, add ¾" to all height dimensions and 1 lb. to weight per unit



Shaded models are available through our Quick Delivery program and will be delivered within 10 days or less. Shaded models that feature the 48 icon will ship within 48 hours (48). See page 6 for additional program information.

TO ORDER, SPECIFY:

1. Model Number
2. Plastic Seat Color
3. Fabric Grade / Cover Number (when applicable)
4. Wood Leg Finish

- See page 469 for Rizora options
- See page 472 for COM fabric yardage

BAR HEIGHT STOOL



Upholstered Seat Pad

MODEL NO.

GRADE / LIST PRICE

QN40B1	Package of 1	\$	813
QN40B2	Package of 2		1582

		1	2/COM	3/COL	4	5	6	7	L7	L8
QN40BU1	Upholstered Seat Pad, Package of 1	\$	921	939	947	960	974	998	1030	
QN40BU2	Upholstered Seat Pad, Package of 2		1796	1814	1822	1835	1849	1873	1905	

DIMENSIONS

Width	18½	Seat Height	30	Weight (1)	13.5
Depth	16	Seat Depth	13¾	Cubic Ft. (1)	6.0
Height	30	Seat Width	15½	Weight (2)	24.0
				Cubic Ft. (2)	6.6

- For the upholstered seat pad models, add ¾" to all height dimensions and 1 lb. to weight per unit

SWIFT

Product Specifications	474
Fabrics and Options	475
Product Pages - Non-Tufting	478

SWIFT PRODUCT SPECIFICATIONS

LOUNGE

FRAME CONSTRUCTION

- Interior frame is constructed of plywood with tenon joints that are glued and screwed for maximum joint stability
- Exterior base frame features wood and metal-look accents
- Each joint is securely glued for maximum joint stability

SEAT CONSTRUCTION

- 4" of high grade polyurethane foam covers a plywood seat panel with high tension strip webbing for comfort

BACK CONSTRUCTION

- 4½" of high grade custom shaped polyurethane foam stretched over web sheet and attached to frame

ARM CONSTRUCTION

- ½" of high grade polyurethane foam covers a plywood constructed arm frame

UPHOLSTERY DETAIL

- Contrasting fabric available on all models
- Railroaded fabrics cannot be specified for vertical tufted models

LEGS

- Extruded aluminum legs with nylon leveling glides

MOBILE UNIT CASTERS

- Black, double wheel, roll control casters are standard and work on all floors

TABLET ARM

- ¾" thick black 3D Laminate with MDF core or ¾" thick maple
- Attached with ¼" steel base plate and screws that mounts over ¼" metal insert rod and fits into structure of arm
- Allows for 360° swivel and writing surface of 21" W x 13½" D

FINISH

- Tablet arm features a catalyzed top coat that resists denting, peeling and reactions to chemicals
- Can be cleaned with a damp cloth
- When specifying Brighton, Natural, and Sonoma finish, variation in color is acceptable due to the nature of wood characteristics

PLINTH BASE

- Available on tufting models only
- Black PVC edge
- Includes leveling glides

GANGING - TUFTING MODELS

- Ganging option available for an additional upcharge on the armless side(s) of lounges, benches and tables
- A right ganging bolt and left V-bracket is necessary for units to be ganged
- To gang units, simply lift unit and insert ganging bolt into ganging V-bracket

TABLES

FRAME CONSTRUCTION

- Grade A slipmatched maple (Brighton, Caramel, Honey, Natural), or cherry veneer (Amber, Autumn, Cordovan, Judicial, Mocha, Truffle) with mitered corners and extruded aluminum legs with rails
- Veneer features a semi-open pore matte sheen

POWER AND DATA GROMMET

- Available in the 30°, 45°, 90° and small end tables
- 3 power grommets available; specify cutout option and order electrical grommet model separately. See pages 645-646 for details and pricing
- Power grommet not available on coffee or console tables

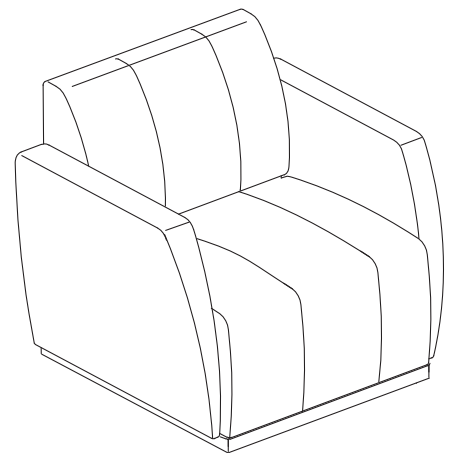
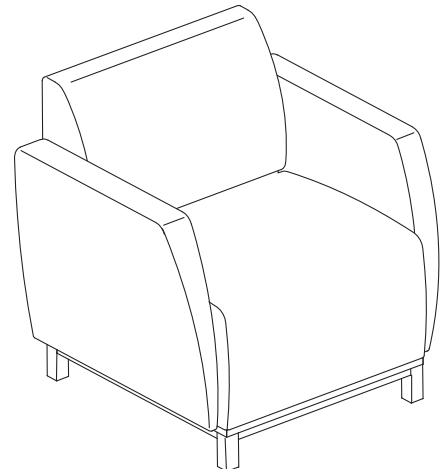

All Swift models may be ordered to meet TB133 fire code with the exception of the Vertical Tufting with Plinth Base models.

To order seating to meet the TB133 fire code, specify an "F" at the end of the model number (Ex: N95MAF).

For TB133 pricing go to
www.NationalOfficeFurniture.com/TB133

Please consult customer service for applicable Arc-Com, Carnegie, Designtex, Maharam, Mayer, Momentum, Stinson, or Ultrafabrics fabric.

FABRICS

Grade 1	Cali Entwine Melange Ridge Spark Vessel Zig Zag
---------	---

Grade 2	Bliss Brilliant Dolce Intuition Orbit Pixie Sedona Stencil Strand
---------	---

Grade 3	Silvertex
---------	-----------

Grade 4	Connect Four Echo Masquerade
---------	------------------------------------

Grade 5	Mode
---------	------

Grade 6	Essence/Ultraleather
---------	----------------------

Grade 7	Brisa Brisa Distressed Reef Pro Silica Tottori
---------	--

**FRAME COLORS -
NON-TUFTING MODELS**

423	Concrete
462	Cinder
463	Iron
497	Polished Aluminum
501	Platinum Metallic
503	Satin Nickel Metallic

**GANGING OPTIONS
TUFTING MODELS ONLY**

(\$69 list upcharge per ganging location)

LOUNGE

L	Ganging Left
R	Ganging Right
LR	Ganging Left and Right
X	No Ganging

TABLES

1	Ganging 1 Side
2	Ganging 2 Sides
X	No Ganging

FINISHES

AC	Autumn	PB	Portobello*
AD	Almond*	PT	Portico*
CL	Caramel	SK	Skyline*
CW	Cordovan	SM	Sonoma*
DW	Judicial	TF	Truffle
HN	Honey	405	Designer White*
IM	Brighton	462	Cinder*
MC	Amber	792	Sable*
MH	Mocha	793	Acorn*†
NM	Natural		

*Not available on tables

†Acorn is the finish and laminate complement to Clear Walnut finish

**GANGING BRACKET DETAILS
(AS SEATED)**

RIGHT SIDE GANGING



Ganging Bolt

LEFT SIDE GANGING

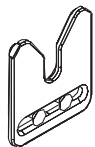

Ganging V-Bracket

SWIFT

SWIFT



Shaded models are available through our Quick Delivery program and will be delivered within 10 days or less. Shaded models that feature the 48 icon will ship within 48 hours (48). See page 6 for additional program information.

TO ORDER, SPECIFY:

1. Model Number
2. Fabric Grade Number
3. Cover Number
4. Tablet (when applicable)
5. Finish Designator
6. Frame Color

• See page 475 for Swift options
See pages 495-498 for COM fabric yardage

1 SEAT LOUNGE

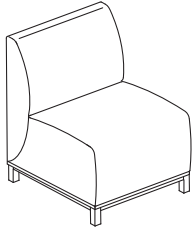

Armless

MODEL NO.

GRADE / LIST PRICE

		1	2/COM	3/COL	4	5	6	7	L7	L8
QN95MA	Armless	\$ 2477	2586	2635	2716	2803	2951	3150		
QN95MAC	Armless - Mobile	2695	2804	2853	2934	3021	3169	3368		
QN95AA	Arms	3225	3425	3516	3664	3824	4097	4462		
QN95AAC	Arms - Mobile	3442	3642	3733	3881	4041	4314	4679		

DIMENSIONS

Armless Width	26½	Arm Height	27¼	Seat Depth	21¼	Armless Weight	49
Arm Width	32	Seat Height	19¼	Back Height	32½	Arm Weight	78
Depth	30	Seat Width	26½	Back Width	26½	Cubic Ft.	26.3
Height	32½						



Shaded models are available through our Quick Delivery program and will be delivered within 10 days or less. Shaded models that feature the 48 icon will ship within 48 hours (48). See page 6 for additional program information.

TO ORDER, SPECIFY:

1. Model Number
2. Fabric Grade Number
3. Cover Number
4. Finish Designator
5. Frame Color

- See page 475 for Swift options
- See pages 495-498 for COM fabric yardage

1 SEAT BENCH

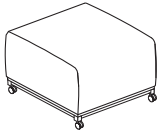
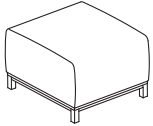

Mobile

MODEL NO.

GRADE / LIST PRICE

		1	2/COM	3/COL	4	5	6	7	L7	L8
QN95DD	1 Seat Bench	\$ 1918	2009	2051	2118	2191	2316	2482		
QN95DDC	1 Seat Bench - Mobile	2136	2227	2269	2336	2409	2534	2700		

DIMENSIONS

Width 26¼
 Depth 30
 Height 19¼

Weight 35
 Cubic Ft. 16.7

- Railroaded fabrics will require a seam on the front and back edges of bench

SWIFT



Shaded models are available through our Quick Delivery program and will be delivered within 10 days or less. Shaded models that feature the 48 icon will ship within 48 hours (48). See page 6 for additional program information.

TO ORDER, SPECIFY:

• See page 475 for Swift options

1. Model Number
2. Surface Grommet
3. Side Grommet
4. Wood/Laminate Finish
5. Frame Color

GANGING BRACKET KIT

MODEL NO.

LIST PRICE

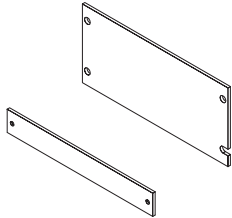

N95TR	1 Bracket Kit	\$ 122
-------	---------------	--------

DIMENSIONS

Weight	2
Cubic Ft.	0.05

- Ganging bracket recommended for use in static applications for rigid ganging
- Ganging bracket intended for armless-to-armless or armless-to-table connections
- 1 bracket kit used for each connection

TAG

TAG

Product Specifications	500
Fabrics and Options	501
Product Pages	503

TAG PRODUCT SPECIFICATIONS

FRAME CONSTRUCTION

- Legs are made of $\frac{7}{8}$ " x 14-gauge tubular steel in either powder coated Cinder or Platinum Metallic
- Cross members constructed of $\frac{3}{4}$ " x 14-gauge tubular steel
- Leg is joined to cross member bar with metal inert gas (MIG) welds
- Back brackets utilize sturdy 11-gauge steel plates
- Bariatric back brackets utilize sturdy 7-gauge steel plates
- Wall saving option available

SEAT CONSTRUCTION

- Guest model features a contoured, blow molded, polyethylene seat pan with molded channels, which incorporate the seat frame cross members
- $\frac{1}{4}$ " thick high resilience polyurethane foam covers seat panel for added comfort and support
- Seat pan is attached to the frame with 4 machine screws and threaded metal inserts (T-nuts)
- Bariatric model features a plywood seat panel and is attached to the frame with 6 machine screws and threaded metal inserts (T-nuts)

BACK CONSTRUCTION—UPHOLSTERED

- Injection molded polypropylene plastic back rest
- Bariatric back features 9-ply curved plywood panel
- $\frac{3}{4}$ " high resilience polyurethane foam covers the front of the back rest while $\frac{1}{4}$ " high density polyurethane foam covers the back of the back rest
- Back rest is secured to the chair frame with 4 countersunk flat head screws, steel back plates and threaded metal inserts (T-nuts)

BACK CONSTRUCTION—WOOD

- 8-ply curved maple plywood back with decorative fasteners, steel back plates and threaded metal inserts (T-nuts)
- Bariatric back features 9-ply curved maple plywood back with decorative fasteners, steel back plates and threaded metal inserts (T-nuts)

FINISH

- A catalyzed top coat that resists denting, peeling and reactions to chemicals
- Can be cleaned with a damp cloth
- When specifying Brighton, Natural, and Sonoma finish, variation in color is acceptable due to the nature of wood characteristics

ARM

- Injection molded arms connect to a metal tubular leg framework with a pressure fit
- Available in black and grey

CONTRASTING FABRICS

- Available contrasting fabric locations on seat and back

TABLE FRAME CONSTRUCTION

- Legs are made of $\frac{7}{8}$ " x 14-gauge tubular steel in either powder coated Cinder or Platinum Metallic
- Cross members constructed of $\frac{3}{4}$ " x 14-gauge tubular steel
- Leg is joined to cross member bar with metal inert gas (MIG) welds

TABLE TOP

- Veneer models feature $\frac{3}{4}$ " grade A slipmatched maple veneer tops
- Laminate models feature $\frac{3}{4}$ " particle board with laminate (HPL) top

GANGING BRACKET

- Set of 2 $2\frac{1}{2}$ " x $5\frac{3}{4}$ " polypropylene ganging brackets snap onto the legs of 2 like model chairs
- Set of 2 metal ganging brackets that fasten into the chair or table frames

TRANSPORT DOLLY

- Tubular steel frame construction with 8" semi-pneumatic ball bearing wheels
- Standard in green powder coat finish
- Designed to move up to 6 chairs at 1 time
- Removable handle allows for storage

STACKING CAPABILITIES

- Static and mobile guest chair models can be stacked up to 6 high
- Bariatric models do not stack
- If stacking chair with arms, 100% vinyl upholstery is not recommended on the seat

FINISH

- Black frames are finished with electrostatically baked-on textured powder coat paint
- Platinum Metallic frames are finished with electrostatically baked-on smooth powder coat paint

GLIDES AND LEG END CAPS

- Black nylon ball glides are standard
- $\frac{7}{8}$ " diameter metal top caps used on armless models match the frame color
- For rough textured or soft surface flooring, we recommend ordering the C8 glide for an additional upcharge

CASTERS

- Black, hard double wheel casters, which work on multiple surfaces, are standard
- Black, soft double wheel casters are available for use on hard floors; upcharge applies to this option

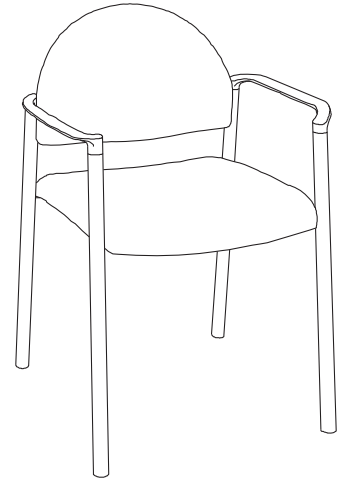

All Tag models may be ordered to meet TB133 fire code.

To order seating to meet the TB133 fire code, specify an "F" at the end of the model number (Ex: N60AAF).

For TB133 pricing go to www.NationalOfficeFurniture.com/TB133

Please consult customer service for applicable Arc-Com, Carnegie, DesignTex, Maharam, Mayer, Momentum, Stinson, or Ultrafabrics fabric.

FABRICS

Grade 1 Cali
 Entwine
 Melange
 Ridge
 Spark
 Vessel
 Zig Zag

Grade 2 Bliss
 Brilliant
 Dolce
 Intuition
 Orbit
 Pixie
 Sedona
 Stencil
 Strand

Grade 3 Silvertex

Grade 4 Connect Four
 Echo
 Masquerade

Grade 5 Mode

Grade 6 Essence/Ultraleather

Grade 7 Brisa
 Brisa Distressed
 Reef Pro
 Silica
 Tottori

GLIDES

STD Standard
 C8 Soft (add \$34 list)

FRAME COLORS

462 Cinder
 501 Platinum Metallic (add \$53 list)

ARM COLORS

BK Black
 GY Grey

TAG



Shaded models are available through our Quick Delivery program and will be delivered within 10 days or less. Shaded models that feature the 48 icon will ship within 48 hours (48). See page 6 for additional program information.

TO ORDER, SPECIFY:

1. Model Number
2. Fabric Grade Number
3. Cover Number
4. Finish (when applicable)
5. Frame Color
6. Arm Color
7. Glides/Casters

- See page 501 for Tag options
- See page 514 for COM fabric yardage

ARC BACK



Arms - Upholstered Back



Armless - Wood Back

MODEL NO.

GRADE / LIST PRICE

		1	2/COM	3/COL	4	5	6	7	L7	L8
QN60AA	Arms - Upholstered Back	\$ 523	555	569	592	618	661	718		
QN60BB	Armless - Upholstered Back	480	512	526	549	575	618	675		

DIMENSIONS

Arm Width	23½	Seat Height	17¾	Arm Height	25	Arm Weight	20
Armless Width	19¾	Seat Depth	17½	Back Height	15¾	Armless Weight	19
Depth	21	Seat Width	18	Back Width	18	Cubic Ft.	11.1
Height	31						

- Platinum Metallic option available
- Can stack 6 high
- If stacking chair with arms, 100% vinyl upholstery is not recommended on the seat
- Chairs will be shipped 4 per carton when applicable

WALL SAVER ARC BACK

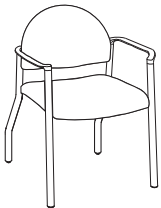

Arms - Upholstered Back

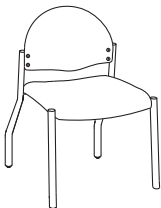

Armless - Wood Back

		1	2/COM	3/COL	4	5	6	7	L7	L8
QN60SAA	Arms - Upholstered Back	\$ 657	689	703	726	752	795	852		
QN60SBB	Armless - Upholstered Back	614	646	660	683	709	752	809		

DIMENSIONS

Arm Width	23½	Seat Height	17¾	Arm Height	25	Arm Weight	20
Armless Width	19¾	Seat Depth	17½	Back Height	15¾	Armless Weight	19
Depth	22¼	Seat Width	18	Back Width	18	Cubic Ft.	11.1
Height	31						

- Platinum Metallic option available
- Can stack 6 high
- If stacking chair with arms, 100% vinyl upholstery is not recommended on the seat
- Chairs will be shipped 4 per carton when applicable

TAG



Shaded models are available through our Quick Delivery program and will be delivered within 10 days or less. Shaded models that feature the 48 icon will ship within 48 hours (48). See page 6 for additional program information.

TO ORDER, SPECIFY:

1. Model Number
2. Fabric Grade Number
3. Cover Number
4. Finish (when applicable)
5. Frame Color
6. Arm Color
7. Glides/Casters

- See page 501 for Tag options
- See page 514 for COM fabric yardage

SQUARE BACK

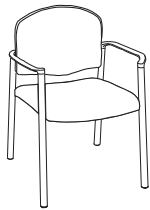

Arms - Upholstered Back



Armless - Wood Back

MODEL NO.

GRADE / LIST PRICE

		1	2/COM	3/COL	4	5	6	7	L7	L8
QN60CC	Arms - Upholstered Back	\$ 613	648	664	690	718	766	830		
QN60DD	Armless - Upholstered Back	568	603	619	645	673	721	785		

DIMENSIONS

Arm Width	23½	Seat Height	17½	Arm Height	25	Arm Weight	20
Armless Width	19¾	Seat Depth	17½	Back Height	15¾	Armless Weight	19
Depth	21	Seat Width	18	Back Width	18	Cubic Ft.	11.1
Height	31						

- Platinum Metallic option available
- Can stack 6 high
- If stacking chair with arms, 100% vinyl upholstery is not recommended on the seat
- Chairs will be shipped 4 per carton when applicable

WALL SAVER SQUARE BACK

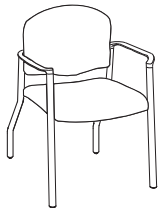

Arms - Upholstered Back

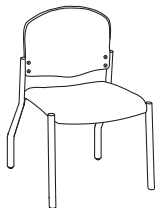

Armless - Wood Back

		1	2/COM	3/COL	4	5	6	7	L7	L8
QN60SCC	Arms - Upholstered Back	\$ 748	783	799	825	853	901	965		
QN60SDD	Armless - Upholstered Back	706	741	757	783	811	859	923		

DIMENSIONS

Arm Width	23½	Seat Height	17½	Arm Height	25	Arm Weight	20
Armless Width	19¾	Seat Depth	17½	Back Height	15¾	Armless Weight	19
Depth	22¼	Seat Width	18	Back Width	18	Cubic Ft.	11.1
Height	31						

- Platinum Metallic option available
- Can stack 6 high
- If stacking chair with arms, 100% vinyl upholstery is not recommended on the seat
- Chairs will be shipped 4 per carton when applicable



Shaded models are available through our Quick Delivery program and will be delivered within 10 days or less. Shaded models that feature the 48 icon will ship within 48 hours (48). See page 6 for additional program information.

TO ORDER, SPECIFY:

• See page 501 for Tag options

1. Model Number

GANGING BRACKET

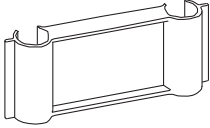

MODEL NO.

LIST PRICE

QN60GB	Plastic	77
--------	---------	----

DIMENSIONS

Width	5¾
Depth	1
Height	2

Weight	1
Cubic Ft.	0.01

- Specify model number only
- 1 pair is required for each ganging connection
- Sold in packages of 5 pairs
- Used to gang like models
- If chair is purchased on same order, brackets will be shipped inside chair carton
- Standard black

TELLARO

Product Specifications	516
Fabrics and Options	517
Product Pages	519

TELLARO

TELLARO PRODUCT SPECIFICATIONS

FRAME CONSTRUCTION

- Interior frame is constructed of plywood with tenon joints that are glued and screwed for maximum joint stability
- Separate interior components are joined with bolts
- Nylon ¾" adjustable leveling glide

SEAT CONSTRUCTION

- Seat cushions are tethered and feature 6" of high grade polyurethane foam, custom shaped and fabricated
- Black denim and ¼" felt insulator cover high tension strip webbing for comfort

BACK CONSTRUCTION

- 4½" of high grade polyurethane foam custom shaped and fabricated covers a plywood panel
- Panel is securely fastened to interior back frame with screws

ARM CONSTRUCTION

- Arms are wrapped with ½" of high grade polyurethane foam custom shaped, fabricated and slip-covered
- Arms are connected to seat and wall frame using 5 bolts per arm

LEGS

- Metal cylinder legs offered in Concrete, Cinder, Iron, Polished, Platinum Metallic, and Satin Nickel Metallic
- Metal U-legs offered in Cinder, Polished, Platinum Metallic, and Satin Nickel Metallic
- Wood U-legs offered in all National seating finishes

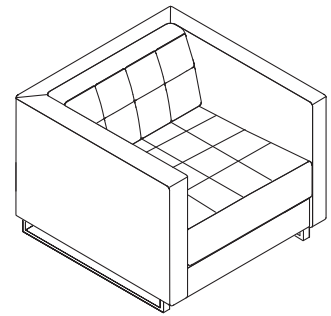
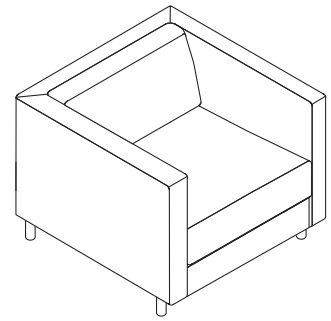
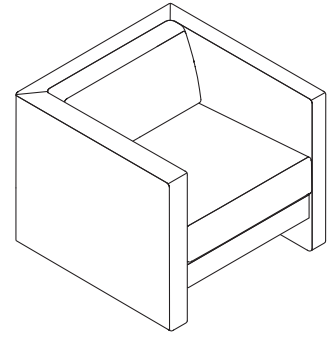

Please contact customer service for Tellaro models that may be ordered to meet TB133 fire code.

To order seating to meet the TB133 fire code, specify an "F" at the end of the model number (Ex: N74M1AF).

For TB133 pricing go to www.NationalOfficeFurniture.com/TB133

Please consult customer service for applicable Arc-Com, Carnegie, Designtex, Maharam, Mayer, Momentum, Stinson, or Ultrafabrics fabric.

FABRICS

Grade 1
 Cali
 Entwine
 Melange
 Ridge
 Spark
 Vessel
 Zig Zag

Grade 2
 Bliss
 Brilliant
 Dolce
 Intuition
 Orbit
 Pixie
 Sedona
 Stencil
 Strand

Grade 3
 Silvertex

Grade 4
 Connect Four
 Echo
 Masquerade

Grade 5
 Mode

Grade 6
 Essence/Ultraleather

Grade 7
 Brisa
 Brisa Distressed
 Reef Pro
 Silica
 Tottori



Shaded models are available through our Quick Delivery program and will be delivered within 10 days or less. Shaded models that feature the 48 icon will ship within 48 hours (48). See page 6 for additional program information.

TO ORDER, SPECIFY:

1. Model Number
2. Fabric Grade / Cover Number
3. Metal / Wood Leg Finish

• See page 517 for Tellaro options
See pages 522-523 for COM fabric yardage

1 SEAT LOUNGE

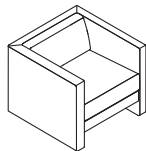

Fully Upholstered Leg
Non-Tufted

MODEL NO.

GRADE / LIST PRICE

		1	2/COM	3/COL	4	5	6	7	L7	L8
FULLY UPHOLSTERED LEG										
QN74M1A	Non-Tufted	\$ 2316	2509	2597	2740	2894	3158	3510		

DIMENSIONS

Width	30%	Seat Width	24	Weight	83
Depth	32%	Seat Depth	21½	Cubic Ft.	23.5
Height	26%	Seat Height	16%		

TIMBERLANE

Product Specifications	526
Fabrics and Options	527
Product Pages	529

TIMBERLANE

TIMBERLANE PRODUCT SPECIFICATIONS—GUEST, TANDEM, BARIATRIC, GANGING TABLES

FRAME CONSTRUCTION

- Frames are constructed of exterior maple with joints double doweled and securely glued for maximum joint stability
- Tandem frame is 1" wide on arms
- Bariatric frame is 1¼" wide on arms
- Non-marring nylon glides

ARM CONSTRUCTION

- Available with black protective polyurethane arm caps for added durability

SEAT CONSTRUCTION

- 2" of high grade polyurethane foam covers a solid seat panel
- Corner blocks are screwed and glued into all 4 corners of the seat

BACK CONSTRUCTION

(39B, 39L, 39D, 39S MODELS)

- Features exterior slats cut from molded maple veneer

(39U, 39E, 39H, 39A MODELS)

- High grade polyurethane foam covers a high density plywood back

CONTRASTING FABRICS

- Available with contrasting fabric on seat and back

FINISH

- A catalyzed top coat resists denting, peeling and reactions to chemicals
- Can be cleaned with a damp cloth
- When specifying Brighton, Natural, and Sonoma finish on tables, variation in color is acceptable due to the nature of wood characteristics

WOOD SPECIES

- Hard maple

TABLES

- Laminate models feature ¾" particle board with laminate (HPL) top and European beech façade rails and legs

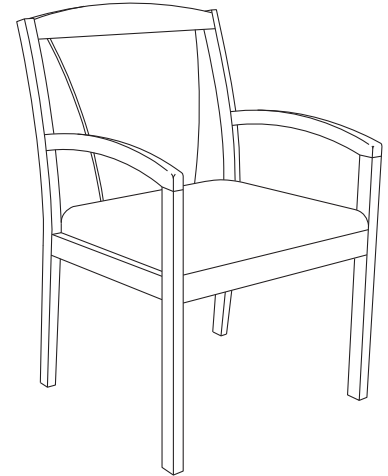

All Timberlane models may be ordered to meet TB133 fire code.

To order seating to meet the TB133 fire code, specify an "F" at the end of the model number (Ex: 39U-GWXXF).

For TB133 pricing go to www.NationalOfficeFurniture.com/TB133

Please consult customer service for applicable Arc-Com, Carnegie, Designtex, Maharam, Mayer, Momentum, Stinson, or Ultrafabrics fabric.

FABRICS

Grade 1
 Cali
 Entwine
 Melange
 Ridge
 Spark
 Vessel
 Zig Zag

Grade 2
 Bliss
 Brilliant
 Dolce
 Intuition
 Orbit
 Pixie
 Sedona
 Stencil
 Strand

Grade 3
 Silvertex

Grade 4
 Connect Four
 Echo
 Masquerade

Grade 5
 Mode

Grade 6
 Essence/Ultraleather

Grade 7
 Brisa
 Brisa Distressed
 Reef Pro
 Silica
 Tottori

FINISHES

AC	Autumn	NM	Natural
AD	Almond	PB	Portobello
BZ	Brazilwood	PC	Porcini
CI	Chai	PT	Portico
CL	Caramel	SK	Skyline
CW	Cordovan	SM	Sonoma
DW	Judicial	TF	Truffle
HN	Honey	WL	Willow
IM	Brighton	405	Designer White
KN	Kona	462	Cinder
MC	Amber	792	Sable
MH	Mocha	793	Acorn*

*Acorn is the finish complement to Clear Walnut finish

TIMBERLANE



Shaded models are available through our Quick Delivery program and will be delivered within 10 days or less. Shaded models that feature the 48 icon will ship within 48 hours (48). See page 6 for additional program information.

TO ORDER, SPECIFY:

1. Model Number
2. Fabric Grade Number
3. Cover Number
4. Finish Designator

• See page 527 for Timberlane options

See page 533 for COM fabric yardage

FULL BACK



Polyurethane Arm Caps

MODEL NO.

GRADE / LIST PRICE

		1	2/COM	3/COL	4	5	6	7	L7	L8
Q39U-GWXX	Upholstered Back - Arm	1121	1162	1180	1210	1243	1298	1373		

DIMENSIONS

Width	22	Arm Height	25¾	Seat Width	20½	Weight	33
Depth	24	Seat Height	18½			Cubic Ft.	13.4
Height	35	Seat Depth	18				

TIZELLE

Product Specifications	536
Fabrics and Options	537
Product Pages	539



TIZELLE

TIZELLE SIDE CHAIR PRODUCT SPECIFICATIONS

FRAME CONSTRUCTION

- Constructed of a solid end frame cut from cross banded baltic birch plywood with exterior maple facing with mortise and tenon joints that are securely glued for maximum joint stability
- Non-marring nylon glides

ARM CONSTRUCTION

- One piece end frame contains arm

SEAT CONSTRUCTION

- 2" high grade polyurethane foam covers a plywood panel with high tension webbing for comfort
- Corner blocks screwed and glued in all 4 corners

BACK CONSTRUCTION

- 2" profile cut high grade polyurethane foam covers plywood back for support and comfort
- The outer (extreme) back features ¼" of high grade polyurethane foam

CONTRASTING FABRICS

- Available with contrasting fabric on seat and back

FINISH

- A catalyzed top coat resists denting, peeling and reactions to chemicals
- Can be cleaned with a damp cloth
- When specifying Brighton, Natural and Sonoma finish, variation color is acceptable due to the nature of wood characteristics

WOOD SPECIES

- Baltic Birch plywood Core with Maple Facing

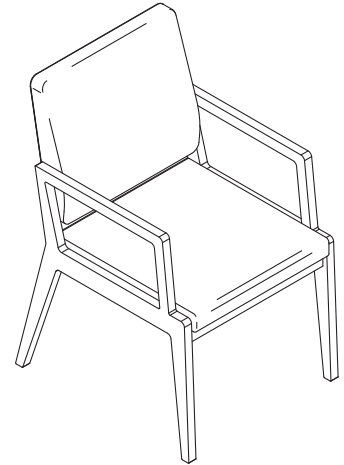

FABRICS

Grade 1
 Cali
 Entwine
 Melange
 Ridge
 Spark
 Vessel
 Zig Zag

Grade 2
 Bliss
 Brilliant
 Dolce
 Intuition
 Orbit
 Pixie
 Sedona
 Stencil
 Strand

Grade 3
 Silvertex

Grade 4
 Connect Four
 Echo
 Masquerade

Grade 5
 Mode

Grade 6
 Essence/Ultraleather

Grade 7
 Brisa
 Brisa Distressed
 Reef Pro
 Silica
 Tottori

FINISHES

AC	Autumn	NM	Natural
AD	Almond	PB	Portobello
BZ	Brazilwood	PC	Porcini
CI	Chai	PT	Portico
CL	Caramel	SK	Skyline
CW	Cordovan	SM	Sonoma
DW	Judicial	TF	Truffle
HN	Honey	WL	Willow
IM	Brighton	405	Designer White
KN	Kona	462	Cinder
MC	Amber	792	Sable
MH	Mocha	793	Acorn*

*Acorn is the finish complement to Clear Walnut finish



Shaded models are available through our Quick Delivery program and will be delivered within 10 days or less. Shaded models that feature the 48 icon will ship within 48 hours (48). See page 6 for additional program information.

TO ORDER, SPECIFY:

1. Model Number
2. Fabric Grade / Cover Number
3. Finish

• See page 537 for Tizelle options
See page 540 for COM fabric yardage

GUEST ARMS



Arms

MODEL NO.

GRADE / LIST PRICE

	1	2/COM	3/COL	4	5	6	7	L7	L8
QN51GFA	\$ 1368	1407	1424	1453	1484	1536	1607		

DIMENSIONS

Width	21	Arm Height	25½	Seat Width	19	Weight	30
Depth	24½	Seat Height	17½	Cubic Ft.	14.1		
Height	35	Seat Depth	19				

GUEST ARMLESS



Armless

	1	2/COM	3/COL	4	5	6	7	L7	L8
QN51GFM	\$ 1348	1387	1404	1433	1464	1516	1587		

DIMENSIONS

Width	21	Arm Height	N/A	Seat Width	19	Weight	28
Depth	24½	Seat Height	17½	Cubic Ft.	14.1		
Height	35	Seat Depth	19				

TOSS ACCENT PILLOWS, BEAN BAGS, CUSHIONS, FLOOR PILLOWS, AND WEDGES

ACCENT PILLOWS

Product Specifications	542
Fabrics and Options	543
Product Pages	545

TOSS ACCENT PILLOWS

TOSS ACCENT PILLOWS PRODUCT SPECIFICATIONS

CONSTRUCTION

SQUARE AND RECTANGLE

- Polyester filled insert with non-woven ticking

RELAXED TOSS PILLOWS

- Relaxed pillow insert has a light, soft fill that is blended from poly fibers, providing a more relaxed pillow aesthetic. It's a perfect complement to our residentially inspired lounge collection, Collette

CLASSIC TOSS PILLOWS

- Classic pillow insert has a heavier, firm fill that is blended from poly fibers, providing a more structured pillow aesthetic for commercial environments

BOLSTER

- Features high grade polyurethane foam with a polyester wrap

CLOSURE

- Nylon zipper

UPHOLSTERY DETAILS

- Contrasting fabric available on all models
- Stitch-it available on select models

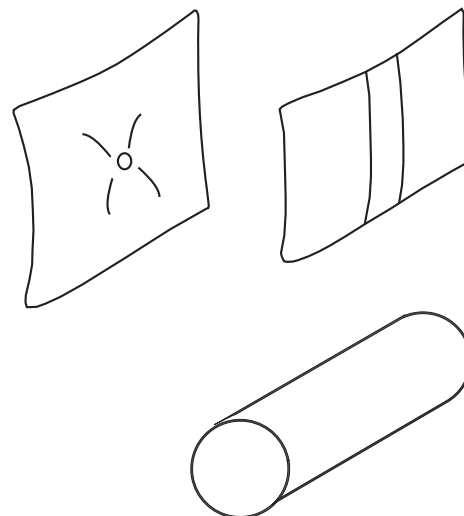

FABRICS

Grade 1
 Cali
 Entwine
 Melange
 Ridge
 Spark
 Vessel
 Zig Zag

Grade 2
 Bliss
 Brilliant
 Dolce
 Intuition
 Orbit
 Pixie
 Sedona
 Stencil
 Strand

Grade 3
 Silvertex

Grade 4
 Connect Four
 Echo
 Masquerade

Grade 5
 Mode

Grade 6
 Essence/Ultraleather

Grade 7
 Brisa
 Brisa Distressed
 Reef Pro
 Silica
 Tottori

FILL INSERT

F1 Classic
 F2 Relaxed

*Not available on bolster



Shaded models are available through our Quick Delivery program and will be delivered within 10 days or less. Shaded models that feature the 48 icon will ship within 48 hours (48). See page 6 for additional program information.

TO ORDER, SPECIFY:

1. Model Number
2. Fill Insert (Not Available on Bolster)
3. Fabric Grade/Color

• See page 543 for Toss Accent Pillows options
See pages 563-565 for COM fabric yardage

BOLSTER

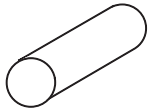

Standard Model

MODEL NO.

GRADE / LIST PRICE

		1	2/COM	3/COL	4	5	6	7	L7	L8
QN10PBL1806	18x6 Bolster	\$ 200	219	228	242	257	283	318		

Weight 3.5
Cubic Ft. 1.8

- Directional fabrics are applied random and may not match from pillow to pillow

SQUARE PILLOW

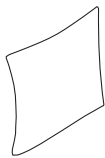

Standard Model

		1	2/COM	3/COL	4	5	6	7	L7	L8
QN10PSQ1414	14x14	\$ 151	171	179	194	209	236	271		
QN10PSQ1616	16x16	\$ 185	207	217	234	252	282	323		
QN10PSQ1818	18x18	\$ 219	243	254	272	290	323	367		

14" Weight 3.5
16" Weight 3.75
18" Weight 4.0
Cubic Ft. 1.8

- Directional fabrics are applied random and may not match from pillow to pillow
- Optional fill insert - Classic or Relaxed

TOSS ACCENT PILLOWS



Shaded models are available through our Quick Delivery program and will be delivered within 10 days or less. Shaded models that feature the 48 icon will ship within 48 hours (48). See page 6 for additional program information.

TO ORDER, SPECIFY:

1. Model Number
2. Fill Insert
3. Fabric Grade/Color

• See page 543 for Toss Accent Pillows options

See pages 563-565 for COM fabric yardage

RECTANGLE PILLOW

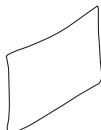

Standard Model

MODEL NO.

GRADE / LIST PRICE

			1	2/COM	3/COL	4	5	6	7	L7	L8
QN10PRT1508	15x8	\$	166	179	184	194	204	222	245		

Weight 3.0
Cubic Ft. 1.8

- Right and left models are as seated
- Directional fabrics are applied random and may not match from pillow to pillow
- Optional fill insert - Classic or Relaxed

TRIUMPH

Product Specifications	568
Fabrics and Options	569
Product Pages	570

TRIUMPH

TRIUMPH PRODUCT SPECIFICATIONS

GUEST FRAME CONSTRUCTION

- All joints are double doweled and securely glued for maximum joint stability
- Features a metal seat frame for added strength
- Non-marring nylon glides

SEAT CONSTRUCTION

- Blow molded polyethylene seat or solid molded plywood panels that are covered with high grade polyurethane foam

BACK CONSTRUCTION

- Solid molded plywood panels are covered with 1½" of high grade polyurethane foam

ARMS

- Arms are made of kiln dried exterior northern hard maple and are attached to the seat with bolts and to the back with a fastener
- Arms on the 89X-EWECC and 89X-MWECC have a protective polyurethane arm cap

ARMS (UPHOLSTERED)

- Arms are made of fiberboard covered with high density polyurethane foam

CONTROL MECHANISM/LIFT

- The standard knee tilt mechanism features a heavy-duty adjustable tension spring for a variety of body sizes and minimal rise of front seat edge; this allows user's feet to remain on the floor when chair is in reclining position
- The combination gas lift/tilt lock lever allows dual function with simple in/out movement for lockout and up/down movement for height adjustment

BASE AND CASTERS

- Nylon base features standard black 5-prong fiberglass reinforced nylon to ensure long life
- Wood base features a standard 5-prong, rigid steel understructure to ensure a long life
- Caster posts fit directly into steel sleeves, greatly reducing caster socket failure
- Decorative hardwood caps complement the chair design
- Black, hard double wheel casters, which work on multiple surfaces, are standard
- Black, soft double wheel casters are available for use on hard floors; upcharge applies to this option

JURY BASE

- Pneumatic jury base
- Auto return swivel



FINISH

- Wood models feature a catalyzed top coat which resists denting, peeling and reactions to chemicals
- Can be cleaned with a damp cloth
- When specifying Brighton, Natural, and Sonoma finish, variation in color is acceptable due to the nature of wood characteristics

WOOD SPECIES

- Hard maple

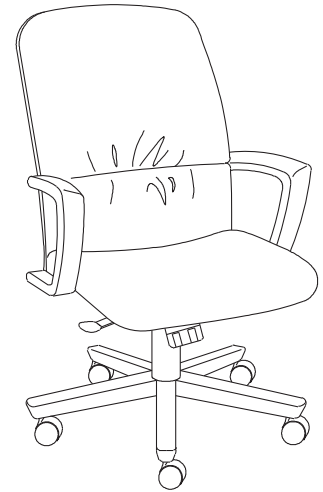

All Triumph models may be ordered to meet TB133 fire code.

To order seating to meet the TB133 fire code, specify an "F" at the end of the model number (Ex: 89X-EWEXCF).

For TB133 pricing go to www.NationalOfficeFurniture.com/TB133

Please consult customer service for applicable Arc-Com, Carnegie, Designex, Maharam, Mayer, Momentum, Stinson, or Ultrafabrics fabric.

FABRICS

Grade 1	Cali Entwine Melange Ridge Spark Vessel Zig Zag
---------	---

Grade 2	Bliss Brilliant Dolce Intuition Orbit Pixie Sedona Stancil Strand
---------	---

Grade 3	Silvertex
---------	-----------

Grade 4	Connect Four Echo Masquerade
---------	------------------------------------

Grade 5	Mode
---------	------

Grade 6	Essence/Ultraleather
---------	----------------------

Grade 7	Brisa Brisa Distressed Reef Pro Silica Tottori
---------	--

FINISHES

AC	Autumn	NM	Natural
AD	Almond	PB	Portobello
BZ	Brazilwood	PC	Porcini
CI	Chai	PT	Portico
CL	Caramel	SK	Skyline
CW	Cordovan	SM	Sonoma
DW	Judicial	TF	Truffle
HN	Honey	WL	Willow
IM	Brighton	405	Designer White
KN	Kona	462	Cinder
MC	Amber	792	Sable
MH	Mocha	793	Acorn*

*Acorn is the finish complement to Clear Walnut finish

CASTERS

FOR PLASTIC BASE

C16	Hard (standard)
C2	Soft (add \$36 list)





Shaded models are available through our Quick Delivery program and will be delivered within 10 days or less. Shaded models that feature the 48 icon will ship within 48 hours (48). See page 6 for additional program information.

TO ORDER, SPECIFY:

1. Model Number
2. Fabric Grade Number
3. Cover Number
4. Finish Designator
5. Casters

• See page 569 for Triumph options
See page 572 for COM fabric yardage

**HIGH BACK
WOOD ARMS WITH
POLYURETHANE
ARM CAPS**



**MODEL
NO.**

GRADE / LIST PRICE

	1	2/COM	3/COL	4	5	6	7	L7	L8
Q89X-EWECC Wood Base	\$ 1870	1933	1962	2009	2059	2145	2261		

DIMENSIONS

Width	26¼	Arm Height	25½-31½	Seat Width	20½	Weight	58
Depth	28	Seat Height	17-22½			Cubic Ft.	17.4
Height	39¼-45¼	Seat Depth	17½				



Shaded models are available through our Quick Delivery program and will be delivered within 10 days or less. Shaded models that feature the 48 icon will ship within 48 hours (48). See page 6 for additional program information.

TO ORDER, SPECIFY:

1. Model Number
2. Fabric Grade Number
3. Cover Number
4. Finish Designator
5. Casters

• See page 569 for Triumph options
See page 572 for COM fabric yardage

**LOW BACK
WOOD ARMS WITH
POLYURETHANE
ARM CAPS**



MODEL NO.	GRADE / LIST PRICE									
	1	2/COM	3/COL	4	5	6	7	L7	L8	
Q89X-MWECC Wood Base	\$ 1827	1883	1909	1950	1995	2072	2174			
DIMENSIONS										
Width	26¼	Arm Height	25½-31½	Seat Width	20½	Weight	57			
Depth	26	Seat Height	17-22½			Cubic Ft.	15.5			
Height	34¼-40¼	Seat Depth	17½							

GUEST



MODEL NO.	GRADE / LIST PRICE									
	1	2/COM	3/COL	4	5	6	7	L7	L8	
Q89X-GWXX Wood Frame	\$ 1163	1216	1240	1279	1321	1393	1489			
DIMENSIONS										
Width	24½	Arm Height	26½	Seat Width	20½	Weight	32			
Depth	25	Seat Height	17¾			Cubic Ft.	13.4			
Height	34	Seat Depth	19							



VOLUTE

Product Specifications	574
Fabrics and Options	575
Product Pages	576

VOLUTE PRODUCT SPECIFICATIONS

SHELL CONSTRUCTION

- Contoured, injection molded polypropylene
- Upholstered model features ½" polyurethane foam

CONTROL, BASE, CASTERS, AND GLIDES

4-Prong High Profile, Static

- Features Trumpet Support with 360° swivel
- Available in Black and Polished Aluminum
- Polyethylene glides are standard
- Felt pad glides are available for an additional upcharge

4-Prong Low Profile, Static

- Features 360° swivel with auto-return
- Available in Black and Polished Aluminum
- Polyethylene glides are standard
- Felt pad glides are available for an additional upcharge

4-Prong High Profile, Mobile

- Features 360° swivel
- Available in Black and Polished Aluminum
- Black, hard double wheel casters, which work on multiple surfaces, are standard
- Soft casters are available for an additional upcharge
- Black, open double wheel casters with polished accents are available for an additional upcharge and work on multiple floors

5-Prong High Profile, Mobile

- Features height adjustment and 360° swivel
- Available in Black and Polished Aluminum
- Black, hard double wheel casters, which work on multiple surfaces, are standard
- Soft casters are available for an additional upcharge
- Black, open double wheel casters with polished accents are available for an additional upcharge and work on multiple floors

4-Leg Wood, Static

- Metal accents available in Black and Polished Aluminum
- Beech wood legs
- Polyethylene glides are standard
- Felt pad glides are available as an option

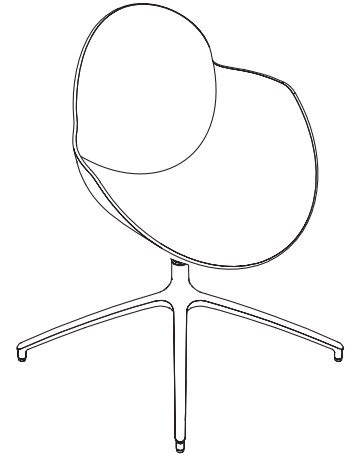

FABRICS

- Grade 1 Cali
- Grade 2 Sedona
- Grade 3 Silvertex

Grade 5 Mode

POLYPROPYLENE SHELL COLORS

- BK Black
- DG Dark Grey

BASE PAINT OPTIONS

- BK Black
- 497 Polished Aluminum

CASTERS

4-PRONG MOBILE AND 5-PRONG MOBILE

- C40 Hard (standard)
- C41 Soft (add \$36 list)
- C70 Open (add \$95 list)

BASE OPTIONS

4-PRONG MOBILE HIGH PROFILE POLISHED ALUMINUM

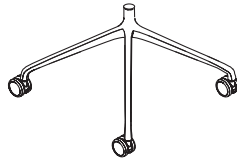

- Available in Black and Polished Aluminum
- 65mm black non-hooded casters - hard, soft, and open

5-PRONG MOBILE HIGH PROFILE POLISHED ALUMINUM, HEIGHT ADJUSTABLE

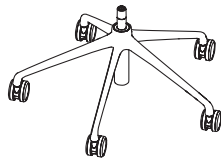

- Available in Black and Polished Aluminum
- 65mm black non-hooded casters - hard, soft, and open

GLIDES

4-PRONG MODELS

- STD Hard (standard)

4-PRONG LOW PROFILE POLISHED ALUMINUM

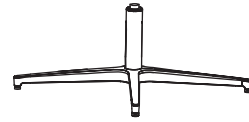

- Available in Black and Polished Aluminum

4-PRONG HIGH PROFILE POLISHED ALUMINUM

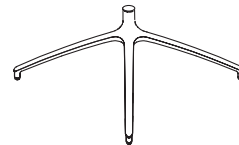

- Available in Black and Polished Aluminum

VOLUTE



Shaded models are available through our Quick Delivery program and will be delivered within 10 days or less. Shaded models that feature the 48 icon will ship within 48 hours (48). See page 6 for additional program information.

TO ORDER, SPECIFY:

• See page 575 for Volute options

1. Model Number
2. Fabric Grade / Cover Number (when applicable)
3. Shell Color
4. Base Paint
5. Glides / Casters

4-PRONG HIGH PROFILE STATIC

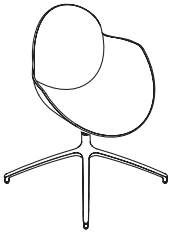

MODEL NO.

GRADE / LIST PRICE

		Maharam Mode				
		1	2	3	5	Gr C
QN46GP4HM	Polypropylene Shell	\$	1148			

DIMENSIONS

Width	24½	Seat Height	17½	Arm Height	7½	Weight U	29
Depth	22½	Seat Depth	16½	Back Width	16½	Weight P	27
Height	32	Seat Width	16½	Back Height	17¼	Cubic Ft.	16.1

4-PRONG HIGH PROFILE MOBILE

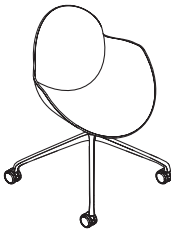

		Maharam Mode				
		1	2	3	5	Gr C
QN46GP4HMC	Polypropylene Shell	\$	1148			

DIMENSIONS

Width	28½	Seat Height	18½	Arm Height	7½	Weight U	29
Depth	28½	Seat Depth	16	Back Width	16½	Weight P	27
Height	32½	Seat Width	16½	Back Height	17½	Cubic Ft.	16.1

4-PRONG LOW PROFILE AUTO-RETURN STATIC

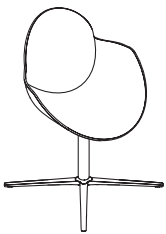

		Maharam Mode				
		1	2	3	5	Gr C
QN46GP4LM	Polypropylene Shell	\$	1256			

DIMENSIONS

Width	24½	Seat Height	17½	Arm Height	7½	Weight U	30
Depth	22½	Seat Depth	16½	Back Width	16½	Weight P	28
Height	31½	Seat Width	16½	Back Height	17¼	Cubic Ft.	16.1

VOLUTE



Shaded models are available through our Quick Delivery program and will be delivered within 10 days or less. Shaded models that feature the 48 icon will ship within 48 hours (48). See page 6 for additional program information.

TO ORDER, SPECIFY:

• See page 575 for Volute options

1. Model Number
2. Fabric Grade / Cover Number (when applicable)
3. Shell Color (when applicable)
4. Paint Color
5. Finish (when applicable)
6. Glides / Casters

**5-PRONG
HEIGHT ADJUSTABLE
MOBILE**

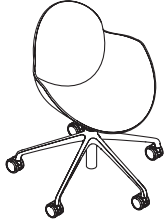

**MODEL
NO.**

GRADE / LIST PRICE

		1	2	3	5	Maharam Mode Gr C
QN46GP5HMC	Polypropylene Shell	\$ 1148				

DIMENSIONS

Width	24½	Seat Height	16%-21½	Arm Height	7%	Weight U	31
Depth	24½	Seat Depth	16½	Back Width	16%	Weight P	29
Height	35¼	Seat Width	16%	Back Height	17¼	Cubic Ft.	16.1

**4-LEG
WOOD**



		1	2	3	5	Maharam Mode Gr C
QN46GP4W	Polypropylene Shell	\$ 1473				

DIMENSIONS

Width	24¼	Seat Height	18¼	Arm Height	7%	Weight U	21
Depth	22½	Seat Depth	16½	Back Width	16%	Weight P	20
Height	33	Seat Width	16%	Back Height	17½	Cubic Ft.	16.1

VOLUTE

VORA

Product Specifications	580
Fabrics and Options	581
Product Pages	582

VORA

VORA PRODUCT SPECIFICATIONS

SEAT CONSTRUCTION

- 2" of polyurethane foam covers a 12 mm cross-banded seat panel

BACK CONSTRUCTION

- Injection molded outer frame

MESH

- 100% Polyester

ARMS

- Encased uprights are made of reinforced glass filled nylon
- Height Adjustable arm adjusts in height with a push button to one of 8 positions with a 2¾" range

CONTROL

- Swivel tilt with one upright locking position
- Knee tilt with six locking positions

BASE AND CASTERS

- Black 50 mm 5-prong base features glass filled nylon
- Black, hard double wheel casters, which work on multiple surfaces, are standard
- Black, 50 mm soft double wheel casters are available on N54MM1ST, N54MM1KT, N54MM3ST, and N54MM3KT; upcharge applies to this option

STOOLS

- Non-tilt swivel control mechanism
- Height adjustable black nylon footring



FABRICS

Grade 1 Cali
 Entwine
 Melange
 Ridge
 Spark
 Vessel
 Zig Zag

Grade 2 Bliss
 Brilliant
 Dolce
 Intuition
 Orbit
 Pixie
 Sedona
 Stencil
 Strand

Grade 3 Silvertex

Grade 4 Connect Four
 Echo
 Masquerade

Grade 5 Mode

Grade 6 Essence/Ultraleather

Grade 7 Brisa
 Brisa Distressed
 Reef Pro
 Silica
 Tottori

FRAME COLOR

BK Black

MESH COLORS

BK Black
 GR Grey

TASK/STOOLS

CASTERS

STD Hard (standard)
 C2 Soft (add \$36 list)

*Soft Caster option only available on select models

PACK

Ships KD or Assembled as specified by the model





Shaded models are available through our Quick Delivery program and will be delivered within 10 days or less. Shaded models that feature the 48 icon will ship within 48 hours (48). See page 6 for additional program information.

TO ORDER, SPECIFY:

1. Model Number
2. Mesh Color (when applicable)
3. Seat Fabric Grade / Cover Number
4. Caster

• See page 581 for Vora options
See page 584 for COM fabric yardage

**BLACK MESH BACK
BLACK SEAT
HEIGHT ADJUSTABLE
ARMS**



48

MODEL NO. GRADE / LIST PRICE

N54BMM3ST	Swivel Tilt, Black Mesh, Black Seat	\$ 690
N54BMM3KT	Knee Tilt, Black Mesh, Black Seat	806

DIMENSIONS

Width	25%	Seat Height (KT)	17¼-21	Arm Height (KT)	24¼-30½	Weight (KT)	29.8
Depth	24¾	Seat Height (ST)	16¾-21	Arm Height (ST)	24¾-31¾	Weight (ST)	26
Height (KT)	38-41½	Seat Depth	17%	Back Height	21	Cubic Ft. (KT)	5.1
Height (ST)	36¾-41	Seat Width	19%	Back Width	18¾	Cubic Ft. (ST)	4.5

- Specify model number only
- Ships KD, tool included

**BLACK MESH BACK
HEIGHT ADJUSTABLE
ARMS**



		1	2/COM	3/COL	4	5	6	7	L7	L8
QN54AMM3ST	Swivel Tilt, Black Mesh	\$ 827	859	873	896	922	965	1022		
QN54AMM3KT	Knee Tilt, Black Mesh	945	977	991	1014	1040	1083	1140		

DIMENSIONS

Width	25%	Seat Height (KT)	17¼-21	Arm Height (KT)	24¼-30½	Weight (KT)	29.8
Depth	24¾	Seat Height (ST)	16¾-21	Arm Height (ST)	24¾-31¾	Weight (ST)	26
Height (KT)	38-41½	Seat Depth	17%	Back Height	21	Cubic Ft. (KT)	5.1
Height (ST)	36¾-41	Seat Width	19%	Back Width	18¾	Cubic Ft. (ST)	4.5

- Personalize seat upholstery
- Caster option not available
- Ships KD, tool included

WEITZ

Product Specifications	586
Fabrics and Options	587
Product Pages	588

WEITZ PRODUCT SPECIFICATIONS

SEAT CONSTRUCTION

- Upholstered seat cushion
- High grade polyurethane foam covers an injection molded nylon seat panel

BASE

- Black injection molded nylon circular base
- Six plastic feet clipped to bottom of base

LEATHER HANDLE

- 1" wide belt leather
- Dark brown leather handle is standard

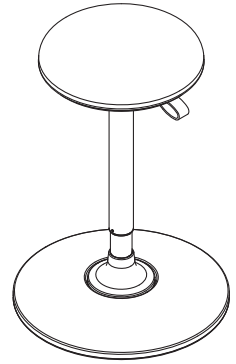

FABRICS

Grade 1
Cali
Entwine
Melange
Ridge
Spark
Vessel
Zig Zag

Grade 2
Bliss
Brilliant
Dolce
Intuition
Orbit
Pixie
Sedona
Stencil
Strand

Grade 3
Silvertex

Grade 4
Connect Four
Echo
Masquerade

Grade 5
Mode

Grade 6
Essence/Ultraleather

Grade 7
Brisa
Brisa Distressed
Reef Pro
Silica
Tottori



Shaded models are available through our Quick Delivery program and will be delivered within 10 days or less. Shaded models that feature the 48 icon will ship within 48 hours (48). See page 6 for additional program information.

TO ORDER, SPECIFY:

1. Model Number
2. Fabric Grade / Cover Number

- See page 587 for Weitz options
- See page 589 for COM fabric yardage

WEITZ STOOL

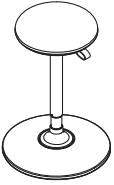

MODEL NO.

GRADE / LIST PRICE

	1	2/COM	3/COL	4	5	6	7	L7	L8
QN96S1	\$ 904	925	935	950	967	996	1034		

DIMENSIONS

Width	15¾	Seat Diameter	12	Cushion Thickness	2	Weight	17
Height	22-32	Base Diameter	15¾			Cubic Ft.	3.7

WELI

Product Specifications	592
Fabrics and Options	593
Product Pages	595

WELI PRODUCT SPECIFICATIONS

SEAT CONSTRUCTION

- 2 $\frac{3}{8}$ " of high grade polyurethane foam covers a plywood seat panel
- Easy clean wipe out feature

FULLY UPHOLSTERED BACK CONSTRUCTION

- 2" of high grade polyurethane foam covers a plywood back panel

FRAME CONSTRUCTION

Guest Seating

- Frame is made from $\frac{3}{4}$ " x 1 $\frac{1}{2}$ " 16-gauge rectangular tube steel
- End frames are joined with inert gas (MIG) welds
- All chairs meet 750 lb. weight capacity
- Wall saving design feature

Lounge

- Interior frame is constructed of plywood tenon joints that are glued and stapled for maximum joint stability
- The legs are screwed directly to the bottom panel of the arm
- All chairs meet 750 lb. weight capacity
- Wall saving design feature

CONTRASTING FABRIC

- Contrasting fabric available on all models

ARM CAPS

- Protective polyurethane is standard on all poly arm models; available in Cinder and Concrete
- Solid Surface is standard on all solid surface arm models; available in 9 colors

GLIDES

- Legs feature a 1" adjustable leveling glide
- Soft glides are available for an additional upcharge

FINISHES

- Cinder, Platinum Metallic, Satin Nickel Metallic, Concrete and Iron frames are finished with an electrostatic baked-on powder coat
- Can be cleaned with a damp cloth

TABLES

FRAME CONSTRUCTION

- Table frame is made from $\frac{7}{8}$ " x 1 $\frac{1}{4}$ " 16-gauge elliptical tubular steel
- Cross members are made from $\frac{7}{8}$ " 16-gauge round tubular steel
- Cross members are joined to the U-bent side members with metal inert gas (MIG) welds

TOPS

- Laminate models feature a 1 $\frac{1}{4}$ " laminate (HPL) top
- Solid Surface models available in Grades A, B, and C

POWER AND USB GROMMET – Lounge only

- Power grommets available; specify cutout option and order electrical grommet model separately
- See pages 91-92 for details and pricing

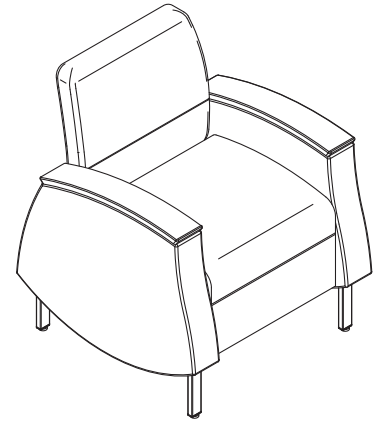
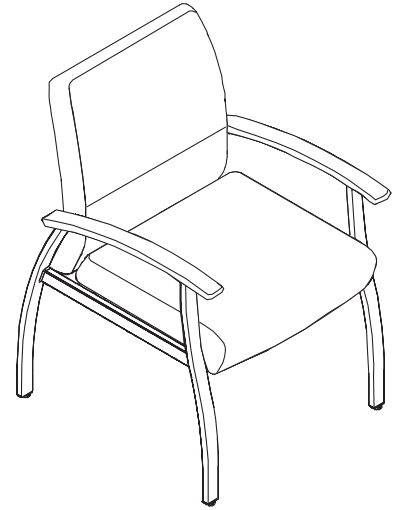

FABRICS

Grade 1	Cali Entwine Melange Ridge Spark Vessel Zig Zag
---------	---

Grade 2	Bliss Brilliant Dolce Intuition Orbit Pixie Sedona Stencil Strand
---------	---

Grade 3	Silvertex
---------	-----------

Grade 4	Connect Four Echo Masquerade
---------	------------------------------------

Grade 5	Mode
---------	------

Grade 6	Essence/Ultraleather
---------	----------------------

Grade 7	Brisa Brisa Distressed Reef Pro Silica Tottori
---------	--

FRAME COLOR

462	Cinder
501	Platinum Metallic

MOISTURE BARRIER

(\$152 upcharge per seat location)

X	No Moisture Barrier
MBS1	Moisture Barrier, 1 Seat
MBS2	Moisture Barrier, 2 Seat
MBS3	Moisture Barrier, 3 Seat

GLIDES

STD	Standard
C66	Soft (add \$41 list)

POLYURETHANE ARM CAP

462	Cinder
-----	--------



Shaded models are available through our Quick Delivery program and will be delivered within 10 days or less. Shaded models that feature the 48 icon will ship within 48 hours (48). See page 6 for additional program information.

TO ORDER, SPECIFY:

1. Model Number
2. Fabric Grade Number
3. Fabric Grade Cover
4. Moisture Barrier
5. Arm Cap (when applicable)
6. Frame Color
7. Glides

• See page 593 for Weli options
See pages 608-609 for COM fabric yardage

21" GUEST CHAIR

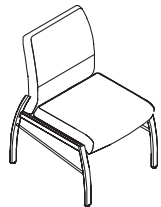

Armless

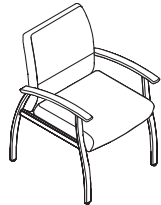

Arm

MODEL NO.

GRADE / LIST PRICE

		1	2/COM	3/COL	4	5	6	7	L7	L8
QN81GAM	Armless	\$ 1617	1670	1694	1733	1775	1847	1943		
QN81GAAY	Arms, Poly	1646	1699	1723	1762	1804	1876	1972		

DIMENSIONS

Armless Width	24	Seat Height	19	Arm Height	25¼	Weight	42
Arm Width	24½	Seat Depth	19	Back Height	36¼	Arm Weight	47
Depth	27	Seat Width	21	Back Width	21	Cubic Ft.	21.1
Height	36¼						

- Soft glide option available
- Guest chairs can be ganged together by using the chair ganging brackets on page 606; brackets are ordered separately

27" GUEST CHAIR

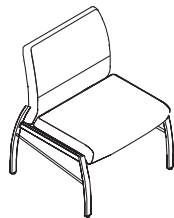

Armless

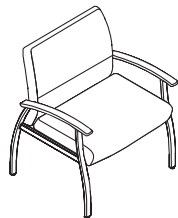

Arm

		1	2/COM	3/COL	4	5	6	7	L7	L8
QN81GBM	Armless	\$ 1939	2027	2067	2132	2202	2322	2482		
QN81GBAY	Arms, Poly	1973	2061	2101	2166	2236	2356	2516		

DIMENSIONS

Armless Width	30	Seat Height	19	Arm Height	25¼	Weight	48
Arm Width	30½	Seat Depth	19	Back Height	36¼	Arm Weight	53
Depth	27	Seat Width	27	Back Width	27	Cubic Ft.	25.5
Height	36¼						

- Soft glide option available
- Guest chairs can be ganged together by using the chair ganging brackets on page 606; brackets are ordered separately



Shaded models are available through our Quick Delivery program and will be delivered within 10 days or less. Shaded models that feature the 48 icon will ship within 48 hours (48). See page 6 for additional program information.

TO ORDER, SPECIFY:

1. Model Number
2. Fabric Grade Number
3. Fabric Grade Cover
4. Moisture Barrier
5. Arm Cap (when applicable)
6. Frame Color
7. Glides

- See page 593 for Weli options
- See pages 608-609 for COM fabric yardage

32" GUEST CHAIR

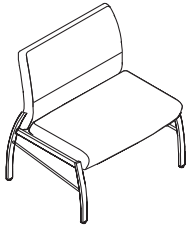

Armless

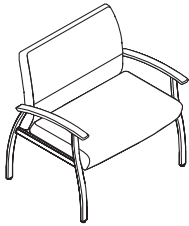

Arm

MODEL NO.

GRADE / LIST PRICE

		1	2/COM	3/COL	4	5	6	7	L7	L8
QN81GCM	Armless	\$ 2263	2351	2391	2456	2526	2646	2806		
QN81GCAY	Arms, Poly	2303	2391	2431	2496	2566	2686	2846		

DIMENSIONS

Armless Width	35	Seat Height	19	Arm Height	25¼	Weight	54
Arm Width	35½	Seat Depth	19	Back Height	36¼	Arm Weight	59
Depth	27	Seat Width	32	Back Width	32	Cubic Ft.	29.1
Height	36¼						

- Soft glide option available
- Guest chairs can be ganged together by using the chair ganging brackets on page 606; brackets are ordered separately

WHIMSY

Product Specifications	612
Fabrics and Options	613
Product Pages	615

WHIMSY PRODUCT SPECIFICATIONS

CONSTRUCTION

- Interior frame is constructed of plywood with tenon joints
- Features 3 $\frac{3}{8}$ " of high grade polyurethane foam seat
- Tufted models feature $\frac{3}{16}$ " round buttons

CONTRASTING FABRICS

- Contrasting fabrics available on all models

STITCH-IT

- Available on 16", 18", and 22" models

CASTERS

- Black, double wheel, roll control casters are standard and work on all floors

GLIDES

- Black, hard and soft combination glides are standard

WOOD LEG

- Non-marring nylon glide
- A catalyzed top coat resists denting, peeling and reactions to chemicals
- Can be cleaned with a damp cloth
- When specifying Brighton, Natural and Sonoma finish, variation color is acceptable due to the nature of wood characteristics

TOPS

Laminate

- Laminate surfaces are $\frac{3}{4}$ " thick HPL and features standard 3mm PVC edge

Solid Surface

- Solid surfaces are $\frac{1}{2}$ " thick and feature a flat rim profile

LEATHER HANDLE

- Available in Chestnut, Camel and Ebony

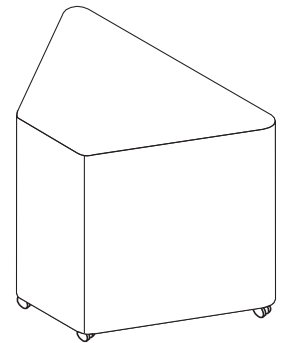
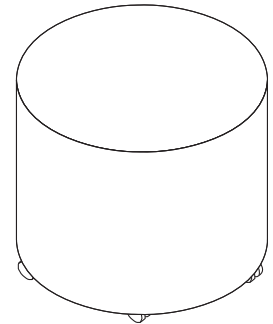
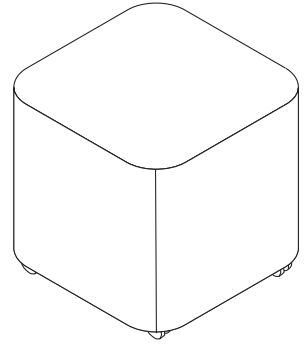

FABRICS

Grade 1	Cali Entwine Melange Ridge Spark Vessel Zig Zag
---------	---

Grade 2	Bliss Brilliant Dolce Intuition Orbit Pixie Sedona Stencil Strand
---------	---

Grade 3	Silvertex
---------	-----------

Grade 4	Connect Four Echo Masquerade
---------	------------------------------------

Grade 5	Mode
---------	------

Grade 6	Essence/Ultraleather
---------	----------------------

Grade 7	Brisa Brisa Distressed Reef Pro Silica Tottori
---------	--

LEATHER HANDLE

(\$103 list upcharge)

EB	Ebony
CH	Chestnut
CA	Camel
X	No Handle





Shaded models are available through our Quick Delivery program and will be delivered within 10 days or less. Shaded models that feature the 48 icon will ship within 48 hours (48). See page 6 for additional program information.

TO ORDER, SPECIFY:

1. Model Number
2. Fabric Grade / Cover Number
3. Leather Handle (when applicable)

- See page 613 for Whimsy options
- See pages 622-623 for COM fabric yardage

ROUND

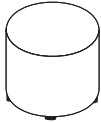

Static

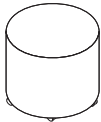

Mobile

MODEL NO.

GRADE / LIST PRICE

		1	2/COM	3/COL	4	5	6	7	L7	L8
QN66RD16G	Static 16"	\$ 715	754	771	800	831	883	954		
QN66RD16C	Mobile 16"	747	786	803	832	863	915	986		
QN66RD18G	Static 18"	785	827	846	877	910	967	1043		
QN66RD18C	Mobile 18"	817	859	878	909	942	999	1075		
QN66RD22G	Static 22"	850	896	917	951	988	1050	1134		
QN66RD22C	Mobile 22"	882	928	949	983	1020	1082	1166		

16" DIMENSIONS

Width	16
Depth	16
Static Height	16
Mobile Height	16¼
Weight	11
Cubic Ft.	4.1

18" DIMENSIONS

Width	18½
Depth	18½
Static Height	17½
Mobile Height	18½
Weight	16
Cubic Ft.	7.3

22" DIMENSIONS

Width	22¾
Depth	22¾
Static Height	17½
Mobile Height	18½
Weight	20
Cubic Ft.	7.3

- Features 3 vertical seams
- Leather handle option on 16", 18", and 22" models only
- 16" and 18" models will be shipped 2 or 4 per carton based on customer order quantity, when applicable
- 22" models will be shipped 2 per carton, when applicable

WHIMSY



Shaded models are available through our Quick Delivery program and will be delivered within 10 days or less. Shaded models that feature the 48 icon will ship within 48 hours (48). See page 6 for additional program information.

TO ORDER, SPECIFY:

1. Model Number
2. Fabric Grade / Cover Number
3. Leather Handle (when applicable)

• See page 613 for Whimsy options
See pages 622-623 for COM fabric yardage

SQUARE

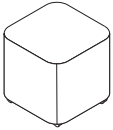

Static

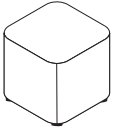

Mobile

MODEL NO.

GRADE / LIST PRICE

		1	2/COM	3/COL	4	5	6	7	L7	L8
QN66SQ16G	Static 16"	\$ 752	791	808	837	868	920	991		
QN66SQ16C	Mobile 16"	785	824	841	870	901	953	1024		
QN66SQ18G	Static 18"	817	880	909	956	1007	1094	1210		
QN66SQ18C	Mobile 18"	850	913	942	989	1040	1127	1243		
QN66SQ22G	Static 22"	882	948	978	1028	1080	1171	1292		
QN66SQ22C	Mobile 22"	910	976	1006	1056	1108	1199	1320		

16" DIMENSIONS

Width	16
Depth	16
Static Height	16
Mobile Height	16½
Weight	13
Cubic Ft.	4.1

18" DIMENSIONS

Width	18¾
Depth	18¾
Static Height	17¾
Mobile Height	18¾
Weight	19
Cubic Ft.	7.3

22" DIMENSIONS

Width	21¾
Depth	21¾
Static Height	17¾
Mobile Height	18¾
Weight	22
Cubic Ft.	7.3

- Leather handle option available
- 16" and 18" models will be shipped 2 or 4 per carton based on customer order quantity, when applicable
- 22" models will be shipped 2 per carton, when applicable

WHIRL

Product Specifications	626
Fabrics and Options	627
Product Pages	629

WHIRL

WHIRL PRODUCT SPECIFICATIONS

FRAME CONSTRUCTION—GUEST MODELS

- Legs and cross member are made of 1" tubular steel
- Available in Cinder powder coat or chrome
- Static models feature durable hard black nylon glides are standard
- Mobile models feature black, hard double wheel casters, which work on multiple surfaces

SEAT CONSTRUCTION

- Task models feature 3" of polyurethane foam covers a 12 mm cross-banded seat panel
- Guest models feature 1½" of polyurethane foam covers a 12 mm cross-banded seat panel

BACK CONSTRUCTION

Mesh Back

- Injection molded outer frame
- 65% Elastomer (Hytrel) Nylon + 35% Polyester

Upholstered Back

- Injection molded polypropylene inner and outer back panels
- Task back features 1½" custom molded polyurethane foam
- Guest back features 1" custom molded polyurethane foam
- Back Rest
 - Back height can be adjusted by simply lifting up on the back
 - Adjusts 6 positions within a range of approximately 2¾"

LUMBAR

- Mesh back models feature a 5" tall lumbar with 4" of adjustability

ARMS

- Encased uprights are made of reinforced glass filled nylon
- Static arm uprights are made of reinforced glass filled nylon with arm pads made from soft polyurethane
- Height adjustable arm adjusts in height with a push button to one of 7 positions with a 2¾" range
- 4D arms have arm pads that adjust in depth, width, pivot, and arm height adjustment all with the touch of a button
 - Arm height range 2¾", 7 positions (outside button)
 - Front to rear adjustment range 2¾" (outside button)
 - Arm pad width adjustment range ¾" (inside button)
 - Arm pad pivot adjustment range 40° (inside button)
- Conference Arm
 - Die cast polished aluminum
 - Arm pads are soft black polyurethane
- Guest arms are black glass filled polypropylene

CONTROL MECHANISM—3 POSITION LOCK SYNCHRO

- 5 positions available in the seat slide depth adjustment range of 2"
- Synchronous control allows the back and seat to move in a synchronized 2:1 ratio motion
- Free float feature allows the chair to tilt freely
- The back angle can be locked in 1 of 3 positions
- Standard pneumatic gas cylinder lift allows seat to raise and lower 4¾" and provides spring action for added comfort
- The combination gas lift/tilt lock lever allows dual functions with a simple in/out movement for lockout and an up/down movement for height adjustment

CONTROL MECHANISM—4 POSITION LOCK SYNCHRO

- 6 positions available in the seat slide depth adjustment range of 2¼"
- A side activated telescoping tension adjustment handle provides a comfortable way to adjust back tension to meet individual needs
- The back angle can be locked in 1 of 4 positions
- Standard pneumatic gas cylinder lift allows seat to raise and lower 4¾" and provides spring action for added comfort
- The combination gas lift/tilt lock lever allows dual functions with a simple in/out movement for lockout and an up/down movement for height adjustment

BASE AND CASTERS

- Features a 5-prong black glass filled nylon base or a polished aluminum cast aluminum base
- Black, hard double wheel casters, which work on multiple surfaces, are standard
- Black, soft double wheel casters are available for use on hard floors; upcharge applies to this option

STOOLS

- 3 position lock synchro control mechanism
- Height adjustable black footring

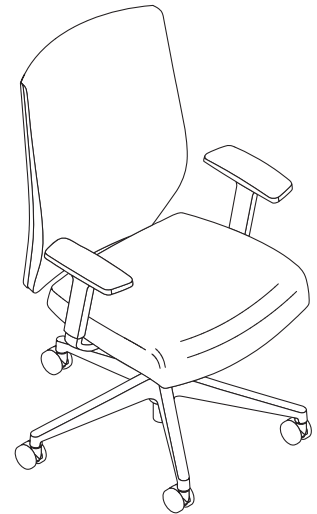
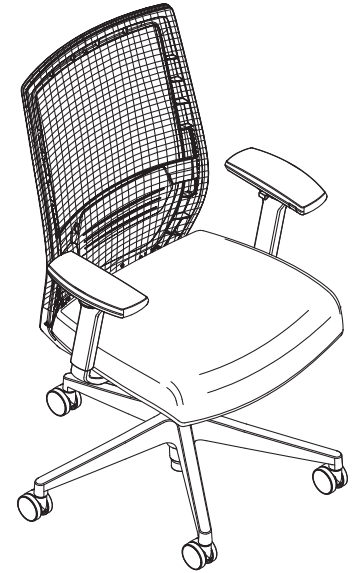

FABRICS

Grade 1 Cali
 Entwine
 Melange
 Ridge
 Spark
 Vessel
 Zig Zag

Grade 2 Bliss
 Brilliant
 Dolce
 Intuition
 Orbit
 Pixie
 Sedona
 Stencil
 Strand

Grade 3 Silvertex

Grade 4 Connect Four
 Echo
 Masquerade

Grade 5 Mode

Grade 6 Essence/Ultraleather

Grade 7 Brisa
 Brisa Distressed
 Reef Pro
 Silica
 Tottori

TASK FRAME COLOR

BK Black
 497 Polished Aluminum Base (add \$133 list)

GUEST FRAME COLOR

BK Black
 490 Chrome
 +\$68 for carton of 1
 +\$204 for carton of 3

**TASK/STOOLS
 CASTERS**

STD Hard (standard)
 C47 Soft (add \$41 list)

*Soft caster option only available on select models

PACK

Ships KD or Assembled as specified by the model





Shaded models are available through our Quick Delivery program and will be delivered within 10 days or less. Shaded models that feature the 48 icon will ship within 48 hours (48). See page 6 for additional program information.

TO ORDER, SPECIFY:

1. Model Number
2. Mesh Color (when applicable)
3. Seat Fabric Grade Number / Cover Number
4. Casters

• See page 627 for Whirl options
See pages 641-642 for COM fabric yardage

**BLACK MESH BACK
BLACK SEAT
HEIGHT ADJUSTABLE
ARMS**



48

MODEL NO.

GRADE / LIST PRICE

3 LOCK SYNCHRO

N28BMML33LSS	Black Mesh, Black Seat Only, Seat Slide	\$	838
--------------	---	----	-----

DIMENSIONS

Width	26½	Seat Height with		Arm Height	25¼-31½	Weight	37.3
Depth	26	Seat Slide	16¾-21½	Back Height	24¼	Cubic Ft.	4.6
Height	39¼-43¾	Seat Depth	17¾	Back Height with			
		Seat Depth with		Seat Slide	24		
		Seat Slide	17¾-19¾	Back Width	18¾		
		Seat Width	18¾				

- Specify model number only
- Ships KD, tool included

**BLACK MESH BACK
HEIGHT ADJUSTABLE
ARMS**



		1	2/COM	3/COL	4	5	6	7	L7	L8
QN28AMML33LSS	3 Lock Synchro, Seat Slide, Black Mesh	\$	978	1010	1024	1047	1073	1116	1173	
QN28AMML34LSS	4 Lock Synchro, Seat Slide, Black Mesh		1048	1080	1094	1117	1143	1186	1243	

DIMENSIONS

Width	26½	Seat Height with		Arm Height (3LSS)	25¼-31½	Weight (3LSS)	28
Depth	26	Seat Slide	16¾-21¼	Arm Height (4LSS)	25¼-31½	Weight (4LSS)	33
Height	39¼-43¾	Seat Depth	17¾	Back Height	24¼	Cubic Ft. (3LSS)	4.6
		Seat Depth with		Back Height with		Cubic Ft. (4LSS)	5.5
		Seat Slide	17¾-19¾	Seat Slide	24		
		Seat Width	18¾	Back Width	18¾		

- Personalize seat upholstery
- Caster option not available
- Ships KD, tool included



Shaded models are available through our Quick Delivery program and will be delivered within 10 days or less. Shaded models that feature the 48 icon will ship within 48 hours (48). See page 6 for additional program information.

TO ORDER, SPECIFY:

1. Model Number
2. Mesh Color (when applicable)
3. Seat Fabric Grade Number / Cover Number
4. Casters (when applicable)

• See page 627 for Whirl options
See pages 641-642 for COM fabric yardage

GUEST MESH BACK

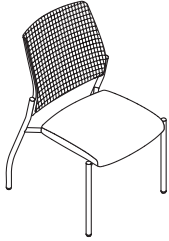

Static

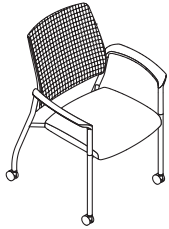

Mobile

MODEL NO.

GRADE / LIST PRICE

		1	2/COM	3/COL	4	5	6	7	L7	L8
ARM										
QN28GMA1	Static, Package of 1	\$ 833	865	879	902	928	971	1028		
QN28GMA3	Static, Package of 3	2084	2140	2166	2207	2252	2329	2431		
QN28GMAC1	Mobile, Package of 1	936	968	982	1005	1031	1074	1131		
QN28GMAC3	Mobile, Package of 3	2244	2300	2326	2367	2412	2489	2591		

DIMENSIONS

Width	21	Seat Height	17	Arm Height	24¾	Weight - Armless (1)	8.40
Depth	22¾	Seat Depth	20	Back Height	16%	Weight - Armless (3)	28.70
Height	33	Seat Width	19½	Back Width	18%	Weight - Arm (1)	9.70
						Weight - Arm (3)	32.60
						Cubic Ft. (1)	12.71
						Cubic Ft. (3)	14.13

- Personalize mesh color and seat upholstery
- For mobile option, add 1" to all heights
- Stacking is not recommended
- Quick Ship models available in black frame only

HEADREST

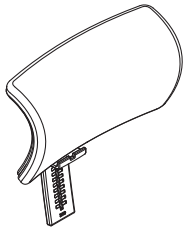

48

N28HRB	Black only	\$ 146
--------	------------	--------

DIMENSIONS

Width	10¾	Weight	4
Depth	4	Cubic Ft.	0.42
Height	5¾-9½		

- Can be added to any mesh back task chair, attachment hardware is included
- Adjust up and down 14 places with a range of 4¾"
- Pivots to allow multiple angles

WHIRL



Shaded models are available through our Quick Delivery program and will be delivered within 10 days or less. Shaded models that feature the 48 icon will ship within 48 hours (48). See page 6 for additional program information.

TO ORDER, SPECIFY:

1. Model Number
2. Fabric Grade Number / Cover Number
3. Casters (when applicable)

• See page 627 for Whirl options

See pages 641-642 for COM fabric yardage

MID BACK BLACK UPHOLSTERED BACK/SEAT PLASTIC EXTREME HEIGHT ADJUSTABLE ARMS



MODEL NO.

GRADE / LIST PRICE

3 LOCK SYNCHRO, SEAT SLIDE

N28BMUPP33LSS	Black Fabric Upholstery, Plastic Extreme	\$ 1144
N28BMUPP33LSS	Black Polyurethane Upholstery, Plastic Extreme	1178

DIMENSIONS

Width	26½	Seat Height	16¾-21½	Arm Height	25¼-31½	Weight	45
Depth	26	Seat Depth	17½-19½	Back Height	24	Cubic Ft.	4.6
Height	39¼-43¾	Seat Width	18¾	Back Width	18½		

- Specify model number only
- Ships KD, tool included

MID BACK UPHOLSTERED HEIGHT ADJUSTABLE ARMS



1 2/COM 3/COL 4 5 6 7 L7 L8

3 LOCK SYNCHRO, SEAT SLIDE

QN28AMUP33LSS	Plastic Extreme	\$ 1286	1330	1350	1382	1417	1477	1557
---------------	-----------------	---------	------	------	------	------	------	------

4 LOCK SYNCHRO, SEAT SLIDE

QN28AMUP34LSS	Plastic Extreme	\$ 1380	1424	1444	1476	1511	1571	1651
---------------	-----------------	---------	------	------	------	------	------	------

DIMENSIONS

Width	26½	Seat Height	16¾-21¼	Arm Height (3LSS)	25¼-31½	Weight (3LSS)	45
Depth	26	Seat Depth	17½-19½	Arm Height (4LSS)	25¼-31½	Weight (4LSS)	50
Height	39¼-43¾	Seat Width	18¾	Back Height	24	Cubic Ft. (3LSS)	4.6
				Back Width	18½	Cubic Ft. (4LSS)	5.5

- Personalize back and seat upholstery
- Caster option not available
- Ships KD, tool included



Shaded models are available through our Quick Delivery program and will be delivered within 10 days or less. Shaded models that feature the 48 icon will ship within 48 hours (48). See page 6 for additional program information.

TO ORDER, SPECIFY:

1. Model Number
2. Fabric Grade Number / Cover Number
3. Casters (when applicable)

• See page 627 for Whirl options
See pages 641-642 for COM fabric yardage

GUEST UPHOLSTERED PLASTIC EXTREME



Static

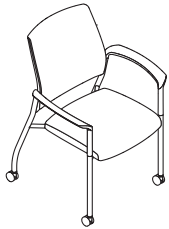

Mobile

MODEL NO.

GRADE / LIST PRICE

		1	2/COM	3/COL	4	5	6	7	L7	L8
ARM										
QN28GUPA1	Static, Package of 1	\$ 934	966	980	1003	1029	1072	1129		
QN28GUPA3	Static, Package of 3	2388	2465	2500	2557	2619	2725	2865		
QN28GUPAC1	Mobile, Package of 1	1037	1069	1083	1106	1132	1175	1232		
QN28GUPAC3	Mobile, Package of 3	2549	2626	2661	2718	2780	2886	3026		

DIMENSIONS

Width	21	Seat Height	17	Arm Height	24¾	Weight - Armless (1)	11.40
Depth	22¾	Seat Depth	20	Back Height	16¾	Weight - Armless (3)	37.70
Height	33	Seat Width	19½	Back Width	18¾	Weight - Arm (1)	12.70
						Weight - Arm (3)	41.60
						Cubic Ft. (1)	12.71
						Cubic Ft. (3)	14.13

- Personalize upholstery
- For mobile option, add 1" to all heights
- Stacking is not recommended
- Quick Ship models available in black frame only

WHIRL



Shaded models are available through our Quick Delivery program and will be delivered within 10 days or less. Shaded models that feature the 48 icon will ship within 48 hours (48). See page 6 for additional program information.

TO ORDER, SPECIFY:

1. Model Number
2. Fabric Grade Number / Cover Number
3. Casters (when applicable)

• See page 627 for Whirl options

See pages 641-642 for COM fabric yardage

GUEST FULLY UPHOLSTERED BACK

MODEL NO.

GRADE / LIST PRICE



Static

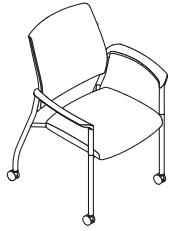

Mobile

		1	2/COM	3/COL	4	5	6	7	L7	L8
ARM										
QN28GUA1	Static, Package of 1	\$ 968	1007	1024	1053	1084	1136	1207		
QN28GUA3	Static, Package of 3	2490	2581	2623	2690	2763	2888	3054		
QN28GUAC1	Mobile, Package of 1	1072	1111	1128	1157	1188	1240	1311		
QN28GUAC3	Mobile, Package of 3	2651	2742	2784	2851	2924	3049	3215		

DIMENSIONS

Width	21	Seat Height	17	Arm Height	24¾	Weight - Armless (1)	11.40
Depth	22¾	Seat Depth	20	Back Height	16¾	Weight - Armless (3)	37.70
Height	33	Seat Width	19½	Back Width	18¾	Weight - Arm (1)	12.70
						Weight - Arm (3)	41.60
						Cubic Ft. (1)	12.71
						Cubic Ft. (3)	14.13

- Personalize upholstery
- For mobile option, add 1" to all heights
- Stacking is not recommended
- Quick Ship models available in black frame only

EFFECTIVE 10.03.22

GLOBAL

Pricing has been updated throughout the price list

ELOQUENCE

Ganging Tables are no longer available with wood top

EFFECTIVE 08.15.22

GENERAL INFORMATION

The following Echo Grade 4 colors are no longer available:

- 41101 Natural
- 41104 Lichen
- 41105 Jute
- 41106 Seaport
- 41107 Limestone

EFFECTIVE 07.15.22

WHIRL

Headrest 1st bullet was revised to:

- Can be added to any mesh back task chair, attachment hardware is included

EFFECTIVE 06.15.22

GRIN AND MABEL

Pixie was deleted from the fabric offerings

EFFECTIVE 05.16.22

KARID

New series added

NATIONAL[®]

1610 ROYAL STREET, JASPER, IN 47546
TOLL FREE 800.482.1717
WEB NATIONALOFFICEFURNITURE.COM

A UNIT OF KIMBALL INTERNATIONAL. ©2018
NPL3QD22