

**GSA Price List Dates:**  
 GSA Pricing 11.03.23  
 USA Commercial Pricing 10.03.22  
 Revisions 03.22.24



**NATIONAL.**

[▶ Follow link](#)

**General Information**

- [GSA Terms and Conditions](#)
- [Terms and Conditions](#)
- [Warranty](#)
- [Sustainability](#)
- [Intellectual Property](#)
- [Surface Materials Reference Guide](#)

[▶ See page](#)

<b>Statement of Line</b>	2
<b>OM Pods</b>	3
Om Sit	4
Om Stand	4
<b>Kolo Pods</b>	5
Kolo 1 & 1 Plus	6
Kolo 2 & ADA-Compliant	7
Kolo 4 & 6	8
<b>Reference</b>	9
Revision Summary	9

# PODS

## Statement of Line

Statement of Line	▶ See page 2
Om Pods	3
Kolo Pods	5

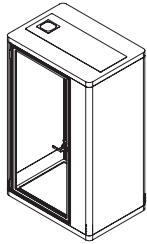

**Om Sit**  
▶ See page 4 to specify.

47"W  
33"D ●

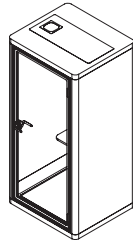

**Om Stand**  
▶ See page 4 to specify.

40"W  
35"D ●

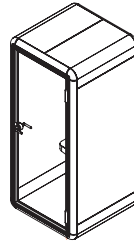

**Kolo 1**  
▶ See page 6 to specify.

42"W  
42"D ●

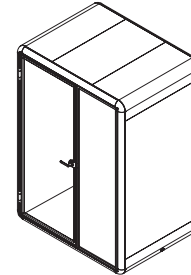

**Kolo 1 Plus**  
▶ See page 6 to specify.

63"W  
51"D ●

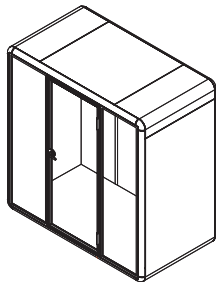

**Kolo 2**  
▶ See page 7 to specify.

87"W  
47"D ●

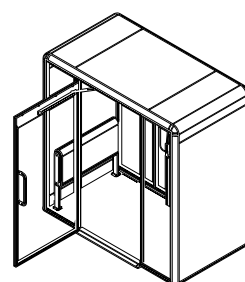

**Kolo 2 ADA Compliant**  
▶ See page 7 to specify.

87"W  
48"D ●

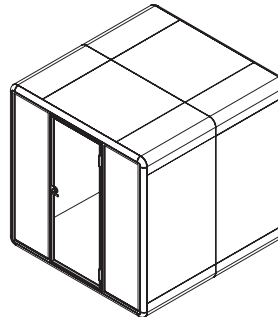

**Kolo 4**  
▶ See page 8 to specify.

87"W  
92"D ●

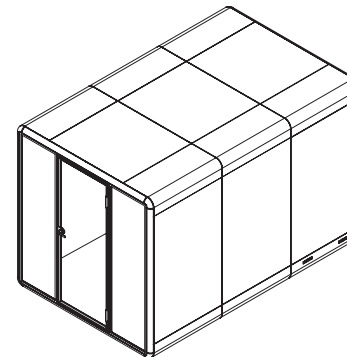

**Kolo 6**  
▶ See page 8 to specify.

87"W  
135"D ●

IMPORTANT: All dimensions shown in the Statement of Line are nominal and have been rounded to the nearest inch. Refer the appropriate pricing pages for actual dimensions.

Statement of Line	➤ See page 2
OM Pods	3
Kolo Pods	5

**Om Sit and Om Stand Pods** are designed to offer a quiet, private space for phone or video calls.

**Best-in-class Anti-Eavesdrop Design** brings you the most private, durable, and flexible phone booth on the market.

**Om Sit** is perfect for longer work sessions. Choose from several seating options; specified separately.

**Om Stand** is ideal for a quick video chat.

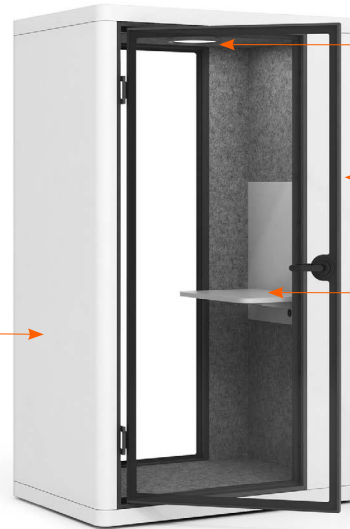

**Motion-activated lights** are dimmable from 1100 lumens.

**Exterior** is made of premium steel.

**Worksurface** is laminate in white or black to match the pod.  
➤ See pricing page for worksurface dimensions.

**Rollers** are standard to allow the pod to move flexibly within your floor plan.

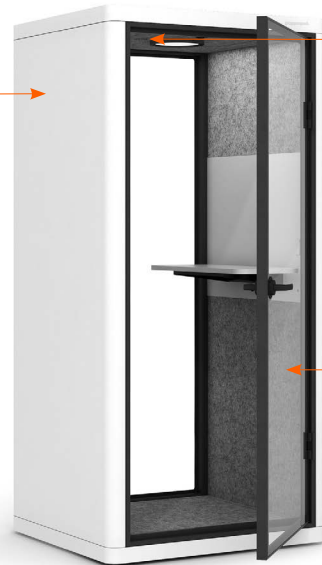

**Sprinkler hole** is precut.

**Motion-activated ventilation (two fans)** increase air circulation, refreshing inside air in less than two minutes.

**Laminated safety glass** on the front and back of unit is impact resistant, reduces reverberations, and can double as a dry erase board.

**NIC Rating:**  
32 dB

**Acoustic Standards:**  
Meets ISO 23351-1

**UL 962 Listed:**  
Pods have gone through extra structural, electrical, and material testing to bring you one of the safest pods on the market.

**Built-in Power:**

- One ethernet port
- Two AC power outlets
- 10 ft. power cord
- Input: 120 VAC
- Output: DC 5V, 2.1A

# OM PODS | OM SIT & OM STAND

Pricing

Statement of Line	➤ See page 2
OM Pods	3
Kolo Pods	5

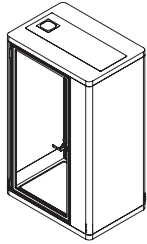

### Om Sit

- Accommodates 1 user and chair, specified separately

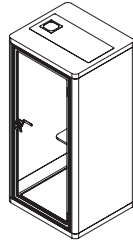

### Om Stand

- Accommodates 1 user and bar-height stool, specified separately

IMPORTANT: Allow 9" above the pod for sufficient air circulation.

Exterior dimensions exclude door handle; add 2.5" for exterior depth for unit with door handle installed.

## Standard Includes

### Black Models

- Pod structure: steel
- Metal panel: black
- Door frame: black
- Worksurface: black laminate
- Dark grey PET interior
- One ethernet port
- Two AC power outlets
- 10 ft. power cord
- Two fans
- Dimmable lighting

### White Models

- Pod structure: steel
- Metal panel: white
- Door frame: black
- Worksurface: white laminate
- Dark grey PET interior
- One ethernet port
- Two AC power outlets
- 10 ft. power cord
- Two fans
- Dimmable lighting

## How to Specify

- 1 Model

Model	Description	Dimensions (Inches)			Price	Shipping		GSA SIN
		D	W	H		lbs.	Cubic Feet	
<b>OM SIT</b>								
PPN108959	BLACK EXTERIOR	32½	47¼	78	\$17958	782.6	70.0	33721
PPN108960	WHITE EXTERIOR	32½	47¼	78	\$17958	782.6	70.0	33721
<b>OM STAND</b>								
PPN108961	BLACK EXTERIOR	35	39½	83½	\$17958	762.8	62.6	33721
PPN108962	WHITE EXTERIOR	35	39½	83½	\$17958	762.8	62.6	33721

Description	Dimensions (Inches)					
	Interior			Worksurface		
	D	W	H	D	W	H from Floor
Om Sit	28	42	71¼	17¾	21½	29½
Om Stand	34	34¼	77	11¾	29	40

Statement of Line	➤ See page 2
OM Pods	3
Kolo Pods	5

**Kolo Pods** are designed to offer a quiet space or conference area. Available in sizes to fit 1 to 6 users (Kolo 4 shown).

**Best-in-class Anti-Eavesdrop Design** keeps confidential conversations, phone calls, and video-conferencing private.

**Exterior** is made of premium steel.

**Rollers** are standard to allow the pod to move flexibly within your floor plan.

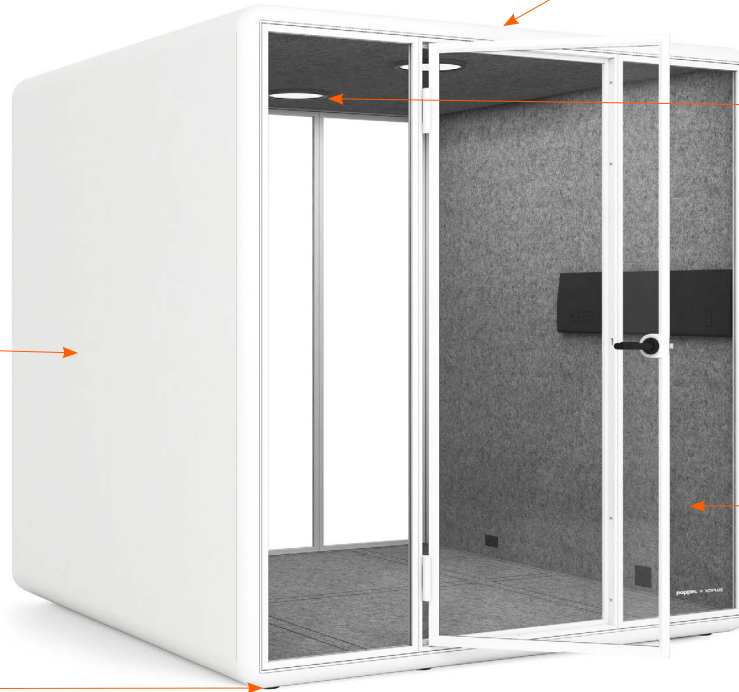

**Motion-activated ventilation fans** increase air circulation, refreshing inside air in less than three minutes.

**Sprinkler hole** is pre-cut.

**Motion-activated lights** are dimmable from 1400 lumens.

**Laminated safety glass** on the front and back of unit is impact resistant, reduces reverberations, and can double as a dry erase board.

**NIC Rating:**  
33 dB

**Acoustic Standards:**  
Meets ISO 23351-1

**UL 962 Listed:**  
Pods have gone through extra structural, electrical, and material testing to bring you one of the safest pods on the market.

- Built-in Power:**
- Ethernet ports
  - USB charging outlets
  - AC power outlets
  - 10 ft. power cord
  - Input: 120 VAC, 10A, 60 Hz
  - Output: DC 5V, 2.1A
- See pricing pages for number of ports and outlets.



- ADA-Compliant Kolo 2 model** features:
- T-shaped turnaround
  - Ramped threshold
  - Anti-slip flooring
  - Fold-down benches
  - Worksurface
  - Automatic door that opens with light touch and closes automatically

# KOLO PODS | KOLO 1 & KOLO 1 PLUS

Pricing

Statement of Line	➤ See page 2
OM Pods	3
Kolo Pods	5

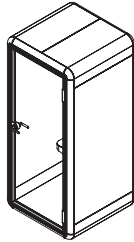

- Kolo 1**
- Accommodates 1 user
  - Worksurface

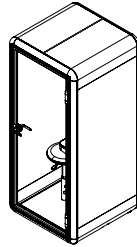

- Kolo 1 with Stool**
- Accommodates 1 user
  - Stationary stool: dark grey upholstery
  - Worksurface

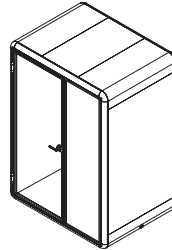

- Kolo 1 Plus**
- Accommodates 1 user
  - Chair and desk may be specified separately

IMPORTANT: Allow 9" above the pod for sufficient air circulation.

Exterior dimensions exclude door handle; add 2.5" for exterior depth for unit with door handle installed.

## Standard Includes

### Black Models

- Pod structure: steel
- Door and window frames: black
- Worksurface on Kolo 1 and Kolo 1 with Stool: white oak laminate with black accent
- Dark grey PET interior
- Two ethernet ports
- Two USB charging outlets
- Four AC power outlets
- 10 ft. power cord
- Two fans for Kolo 1 and Kolo 1 with Stool; four fans for Kolo 1 Plus
- Dimmable lighting

### White Models

- Pod structure: steel
- Door and window frames: white
- Worksurface on Kolo 1 and Kolo 1 with Stool: white oak laminate with white accent
- Dark grey PET interior
- Two ethernet ports
- Two USB charging outlets
- Four AC power outlets
- 10 ft. power cord
- Two fans for Kolo 1 and Kolo 1 with Stool; four fans for Kolo 1 Plus
- Dimmable lighting

Model	Description	Dimensions (Inches)			Price	Shipping		GSA SIN
		D	W	H		lbs.	Cubic Feet	
<b>KOLO 1</b>								
PPN108948	BLACK EXTERIOR	42¼	42	89½	\$24693	795.9	72.5	33721
PPN108949	WHITE EXTERIOR	42¼	42	89½	\$24693	795.9	72.5	33721
<b>KOLO 1 WITH STOOL</b>								
PPN109345	BLACK EXTERIOR	42¼	42	89½	\$25367	814.6	74.4	33721
PPN109346	WHITE EXTERIOR	42¼	42	89½	\$25367	814.6	74.4	33721
<b>KOLO 1 PLUS</b>								
PPN108946	BLACK EXTERIOR	50½	63	89½	\$35918	1172.0	62.6	33721
PPN108947	WHITE EXTERIOR	50½	63	89½	\$35918	1172.0	62.6	33721

Description	Dimensions (Inches)					
	Interior			Worksurface		
	D	W	H	D	W	H from Floor
Kolo 1	36	34	83	12	31¼	41
Kolo 1 with Stool	36	34	83	12	31¼	41
Kolo 1 Plus	45½	58	83	—	—	—

## How to Specify

- 1 Model

Statement of Line	➤ See page 2
OM Pods	3
Kolo Pods	5

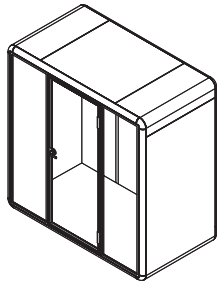

**Kolo 2**

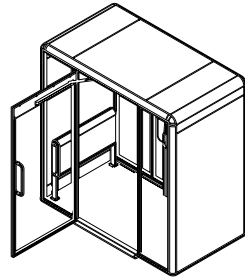

**ADA-Compliant Kolo 2**

- Two fold-down benches
- Fold-down worksurface

IMPORTANT: Allow 9" above the pod for sufficient air circulation.

Exterior dimensions exclude door handle; add 2.5" for exterior depth for unit with door handle installed.

**Standard Includes**

**Black Models**

- Pod structure: steel
- Door and window frames: black
- Dark grey PET interior
- Two ethernet ports on Kolo 2; one ethernet port on ADA-Compliant Kolo 2
- Two USB charging outlets
- Four AC power outlets
- 10 ft. power cord
- Dual-fan ventilation system; four fans
- Dimmable lighting

**White Models**

- Pod structure: steel
- Door and window frames: white
- Worksurface on ADA-compliant Kolo 2: white oak laminate with white accent
- Dark grey PET interior
- Two ethernet ports on Kolo 2; one ethernet port on ADA-Compliant Kolo 2
- Two USB charging outlets
- Four AC power outlets
- 10 ft. power cord
- Dual-fan ventilation system; four fans
- Dimmable lighting

Model	Description	Dimensions (Inches)			Price	Shipping		GSA
		D	W	H		lbs.	Cubic Feet	
<b>KOLO 2</b>								
PPN108950	BLACK EXTERIOR	47 <sup>1</sup> / <sub>4</sub>	87	89	\$49388	1426.0	85.0	33721
PPN108951	WHITE EXTERIOR	47 <sup>1</sup> / <sub>4</sub>	87	89	\$49388	1426.0	85.0	33721
<b>ADA-COMPLIANT KOLO 2</b>								
PPN108993	WHITE EXTERIOR	48	86 <sup>3</sup> / <sub>4</sub>	87 <sup>3</sup> / <sub>4</sub>	\$83063	1455.0	93.0	33721

Description	Dimensions (Inches)								
	Interior			Benches			Table		
	D	W	H	D	W	H	D	W	H from Floor
Kolo 2	45 <sup>1</sup> / <sub>2</sub>	81 <sup>1</sup> / <sub>2</sub>	83	—	—	—	—	—	—
ADA Kolo 2	43 <sup>3</sup> / <sub>4</sub>	81 <sup>3</sup> / <sub>4</sub>	84 <sup>3</sup> / <sub>4</sub>	20	36 <sup>3</sup> / <sub>4</sub>	16 <sup>3</sup> / <sub>4</sub>	22 <sup>1</sup> / <sub>2</sub>	28 <sup>1</sup> / <sub>2</sub>	31 <sup>1</sup> / <sub>2</sub>

**How to Specify**

- 1 Model

Statement of Line	➤ See page 2
OM Pods	3
Kolo Pods	5

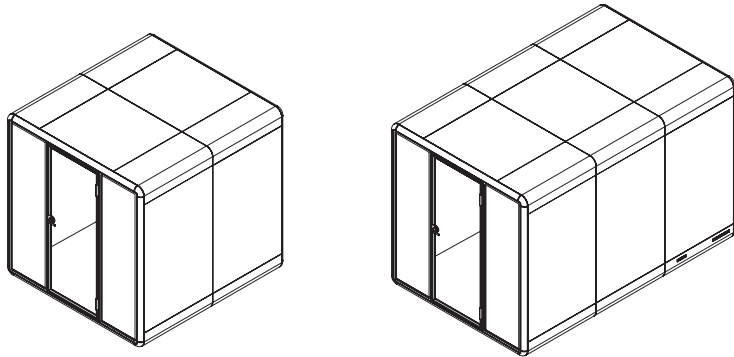

**Kolo 4**

**Kolo 6**

IMPORTANT: Allow 9" above the pod for sufficient air circulation.

Exterior dimensions exclude door handle; add 2.5" for exterior depth for unit with door handle installed.

**Standard Includes**

**Black Models**

- Pod structure: steel
- Door and window frames: black
- Dark grey PET interior
- Two ethernet ports
- Two USB charging outlets
- Six AC power outlets on Kolo 4 and eight AC power outlets on Kolo 6
- 10 ft. power cord
- Dual-fan ventilation system; eight fans on Kolo 4 and twelve fans on Kolo 6
- Dimmable lighting

**White Models**

- Pod structure: steel
- Door and window frames: white
- Dark grey PET interior
- Two ethernet ports
- Two USB charging outlets
- Six AC power outlets on Kolo 4 and eight AC power outlets on Kolo 6
- 10 ft. power cord
- Dual-fan ventilation system; eight fans on Kolo 4 and twelve fans on Kolo 6
- Dimmable lighting

Model	Description	Dimensions (Inches)			Price	Shipping		GSA SIN
		D	W	H		lbs.	Cubic Feet	
<b>KOLO 4</b>								
PPN109415	BLACK	91¾	87	89	\$78573	2189.0	151.0	33721
PPN109416	WHITE	91¾	87	89	\$78573	2189.0	151.0	33721
<b>KOLO 6</b>								
PPN109417	BLACK	135	87	89	\$107758	2952.0	217.0	33721
PPN109418	WHITE	135	87	89	\$107758	2952.0	217.0	33721

Description	Dimensions (Inches)		
	D	W	H
Kolo 4	89	81½	83
Kolo 6	132¾	81½	83

**How to Specify**

- 1 Model



# REVISION SUMMARY

---

03.22.24

## Global

**Pods** are now on GSA contract.

## Reference

This section provides a summary of revisions made to the price list by release date, providing a one-year look back.

# NATIONAL.®

**PODS**

FEDERAL GOVERNMENT CONTRACT GS-03F-059DA

PRICING 11.03.23

Products on contract are noted with applicable Special Item Number (SIN); items not on contract are noted as non-contract.

Product details and other data are subject to change without notice.

General Services Administration  
Federal Supply Service  
Authorized Federal Supply Schedule

Online access to contract ordering information terms and conditions, up-to-date pricing, and the option to create an electronic delivery order is available through GSA Advantage!™, a menu-driven database system.

The internet address for GSA Advantage!™ is:  
[gsaadvantage.gov](http://gsaadvantage.gov)

FSC Group: Large Category Furniture & Furnishings  
FSC Class(es) / Product Code(s): 7125 for SIN 33721; 7110 for SIN 33721P; 7110 for SIN 339113H; 7105 for SIN 532289  
Service Code: 7110  
Contract Number: GS-03F-059DA  
Expiration: February 11, 2026  
CCR Cage Code: 4V077  
Business Size: Large

Contractor:  
Kimball International, Inc.  
1600 Royal Street  
Jasper, IN 47546  
Telephone : 800.482.1213  
[kimballinternational.com](http://kimballinternational.com)