







Advantages of TOSIBOX®

- 
Simple
 Build and manage secure OT infrastructure in minutes
- 
Secure
 Tested & audited security
- 
Modular
 Unlimited expandability and flexibility
- 
Timeless
 Deals with legacy and future systems
- 
Unique
 Globally patented point-to-point connection

TOSIBOX® 175 (with three antennas)

Cost-effective Plug & Go™ connectivity device

TOSIBOX® 175 is ideal for demanding industry sectors that require an all-in-one solution that is compact, able to handle all environments and suited to global market usage. The 4G module and external 4G antenna provides stable Internet access, so the node can be easily configured anywhere. The versatile connectivity options, utilized in conjunction with leading edge Cyber security technology from Tosibox enable diverse application scenarios. The durable aluminium alloy shell and small form factor allows for ideal mounting conditions. Creating secure and sustainable infrastructure has never been this easy.

The node is compatible with all existing TOSIBOX® products.

Main features

Performance

- High VPN throughput, end-to-end encryption between Tosibox devices, users and servers

Reliability

- Integrated WiFi as connectivity method or access point for wireless devices on site
- Built-in global LTE modem – no external modem needed
- TosiOnline™ automatic reconnection of dropped connections

Industrial design

- Robust and fanless enclosure, DIN rail attachment

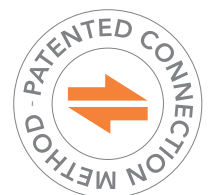

TOSIBOX® 175 Technical Data

Product code TBL175

Certifications CE, FCC, RCM, MIC/JATE

Ports

- 1 x RJ-45 WAN connection, 10/100 Mb/s, auto-negotiation (MDI / MDI-X)
- 1 x RJ-45 LAN connection, 10/100 Mb/s, auto-negotiation (MDI / MDI-X)
- LAN can be assigned as Service connection, 10/100 Mb/s, auto-negotiation (MDI / MDI-X)
- RS485 port is not supported in the software. The device can be powered through the port

Connections

- 9-35V DC
- 2 x WiFi antenna connector, RP-SMA Male
- 1 x LTE antenna connector, SMA Female
- DIN rail attachment (back)

Connection features

- 3-way WAN priority
- Proxy server support
- WAN access with static addressing or DHCP
- Network Time Protocol (NTP) server
- Automatic LAN network discovery
- LAN access with mixed static addressing and DHCP server
- Static routes
- Works in all Internet connections (operator independent)
- Firewall friendly
- Works with dynamic, static and private IP addresses
- Built-in firewall, NAT
- Up to 10 concurrent VPN connections
- VPN throughput up to 10 Mbit/s
- TosiOnline™ Automatic network recovery that recovers from most mobile operator and modem problems

4G Module

- Cellular module: Quectel EG25-G
- Region: GLOBAL
- LTE Cat-4
- Up to 150 Mbps DL, 50 Mbps UL

Frequency Bands

- LTE FDD: B1, B2, B3, B4, B5, B7, B8, B12, B13, B18, B19, B20, B25, B26, B28
- LTE TDD: B38, B39, B40, B41
- WCDMA: B1, B2, B4, B5, B6, B8, B19

WLAN

- IEEE 802.11 b/g, 2.4 GHz, max. 150 Mbps
- Encryptions WEP, WPA-PSK, WPA2-PSK, WPA-PSK/WPA2-PSK mixed mode
- Frequency 2.412 – 2.462 GHz, 11 channels
- Access point or client mode
- Output power 20 dBm max

Included accessories

- RJ-45 Cat5e Ethernet cable
- 1 x LTE antenna
- 2 x WiFi antenna
- DIN rail mount
- DC feed plug
- Wall mounting screw set
- Power supply unit
 - AC adapter - Input 100 – 240 V AC, frequency 50/60Hz 0,3A, Output 12.0 V, 1.0 A, max 12.0 W. EU, UK, AU and US power socket

Physical properties

- 104 mm x 28 mm x 110 mm / 4.09" x 1.10" x 4.33" (L x W x H)
- Storage temperature -30 °C ... +70 °C / -22 °F ... +158 °F
- Weight 305 g / 0.67 lbs (net weight article)
- Operating temperature -20 °C...+55°C / -4°F...131°F
- Power supply operating temperature: 0 °C ... +40 °C/ 32 °F ... +104 °F
- Power supply storage temperature: -20 °C ... +80 °C/ -4 °F ... +176 °F

Safety Precaution

- Do not use the provided power supply at temperatures exceeding 40 °C. To use the device in high temperatures, replace the power supply with a source rated for the used temperature.

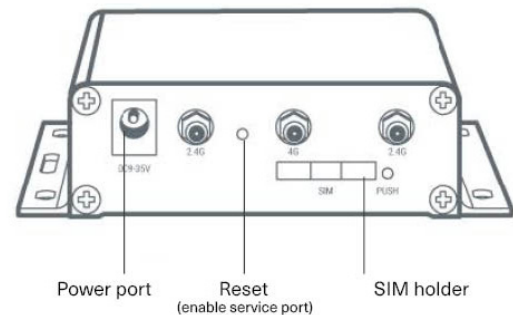
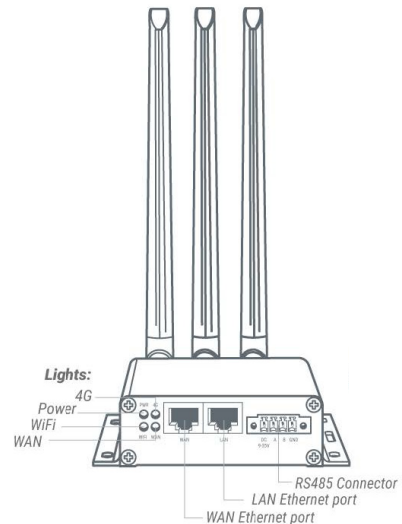

Tosibox

sales@tosibox.com
support@tosibox.com
www.tosibox.com



TOSIBOX

Copyright © 2023 Tosibox. All rights reserved.