

SERVICE SCHEDULE

Maintenance Intervals

Maintenance work must be done at regular intervals. Failure to do so will result in excessive wear and early failures.

The service schedule decal is a guide for correct maintenance of the excavator.

The maintenance items listed under the maintenance intervals on the following pages are the required tasks to be performed. Those items provide additional details and include maintenance that is not shown on the decal.

All maintenance intervals are for machines operating in general environmental conditions. Keep in mind that filter and oil life can be reduced:

- When machines are operating in high dust environments or extreme temperature applications,
- When fuel is taken from uncontrolled storage tanks,
- When other non-standard conditions exist.

For more details, contact your dealer.

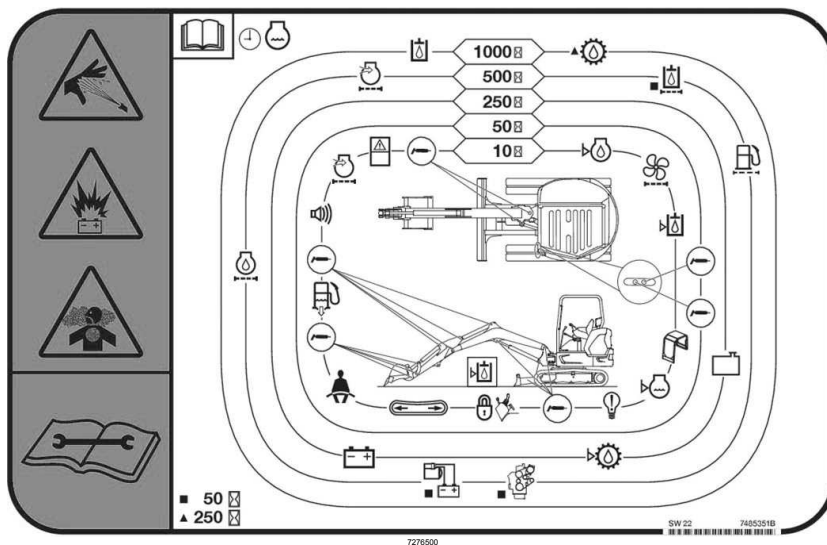

⚠ WARNING

INSUFFICIENT INSTRUCTIONS HAZARD

Untrained operators or failure to follow instructions can cause serious injury or death.

- Read and understand the Operation & Maintenance Manual, Operator's Handbook and decals on machine.
- Follow warnings and instructions in the manuals when making repairs, adjustments or servicing.
- Check for correct function after adjustments, repairs or service.

W-2003

Service Schedule

Maintenance Intervals





Maintenance work must be done at regular intervals. Failure to do so will result in excessive wear and early failures.

[Either the href or the keyref attribute should be set on graphic elements]

Explanation of the service intervals:









- **10:** Every 10 hours or daily (before starting the machine).
- **50:** Every 50 hours.
- **250:** Every 250 hours or every 12 months, whichever comes first.
- **500:** Every 500 hours or every 12 months, whichever comes first.







- **750:** Every 750 hours or every 12 months, whichever comes first.
- **1000:** Every 1000 hours or every 12 months, whichever comes first.
- **2000:** Every 2000 hours or every 24 months, whichever comes first.

Service Schedule									
O	Check condition / proper operation. Adjust or replace as needed.					V	Refill as needed.		
D	Drain water.					C	Clean.		
W	Service every 10 hours when operating in water.					R	Replace.		
F	First time only.					G	Grease.		
Item	Service Required	Service Interval (hours)							
		10	50	100	250	500	1000	2000	
Engine Air Filters and Air System 	<ul style="list-style-type: none"> • Outer Air Filter • Inner Air Filter 	O				R			
Engine Oil and Filter  	<ul style="list-style-type: none"> • Engine Oil: <ul style="list-style-type: none"> ▷ SAE 15W-40 ▷ SAE 10W-30 ▷ Synthetic SAE 5W-40 • Engine Oil Filter 	V				R			
Hydraulic Fluid 	<ul style="list-style-type: none"> • Hydraulic Fluid 	V					R		
Engine Coolant 	Coolant level (check cold) <ul style="list-style-type: none"> • Propylene Glycol Coolant 	V					R		

Service Schedule

O	Check condition / proper operation. Adjust or replace as needed.		V	Refill as needed.
D	Drain water.		C	Clean.
W	Service every 10 hours when operating in water.		R	Replace.
F	First time only.		G	Grease.

Item	Service Required	Service Interval (hours)						
		10	50	100	250	500	1000	2000
Tracks 	Tension	O						
Operator Cab (if equipped) 	Filter <ul style="list-style-type: none"> • HVAC Air Filter (If Equipped): <ul style="list-style-type: none"> ▷ Fresh Air ▷ Recirculation 	C O						
Safety Signs (decals)		C O						
Seat Belt	Seat belt, mounting hardware, and seat belt retractors	C O						
Control Console Lockout		O						
Attachment Coupler (if equipped)		O						
Motion Alarm and Horn (if equipped)		O						
Operator Canopy / Cab	Canopy / cab, mounting hardware	O						
Indicators and Lights		O						
Pivot Points 	Pivot points, clamp (if equipped)	G						
Swing Bearing 	Swing bearing, swing pinion	W	G					
Alternator 	Belt		F O			O		
Battery 	Cables and electrical connections				O			
Fuel Tank 					D			
Pre-Filter 	Drain Water	D						

Service Schedule								
O	Check condition / proper operation. Adjust or replace as needed.				V	Refill as needed.		
D	Drain water.				C	Clean.		
W	Service every 10 hours when operating in water.				R	Replace.		
F	First time only.				G	Grease.		
Item	Service Required	Service Interval (hours)						
		10	50	100	250	500	1000	2000
Fuel Filter 	<ul style="list-style-type: none"> Fuel Filter 					R		
Spark Arrester 				C				
Travel Motors (Final Drive) 	Fluid <ul style="list-style-type: none"> Gear Lube HD 80W-90 				VF R		R	
Hydraulic System 	Hydraulic filter <ul style="list-style-type: none"> Primary Hydraulic Filter 			FR		R		
Alternator and Starter 	Electrical connections		FO			O		
Hydraulic System 	Breather cap					R		
Engine Cooling System 	Radiator, fuel cooler, and hydraulic fluid cooler				C			
Cab Heater (if equipped)	Housing and coils					C		
Engine Valves	Clearance						O	