

SERVICE SCHEDULE

Maintenance Intervals

Maintenance work must be done at regular intervals. Failure to do so will result in excessive wear and early failures.

The service schedule decal is a guide for correct maintenance of the excavator.

The maintenance items listed under the maintenance intervals on the following pages are the required tasks to be performed. Those items provide additional details and include maintenance that is not shown on the decal.

All maintenance intervals are for machines operating in general environmental conditions. Keep in mind that filter and fluid life can be reduced:

- When machines are operating in high dust environments or extreme temperature applications.
- When other non-standard conditions exist.

For more details, contact your dealer.

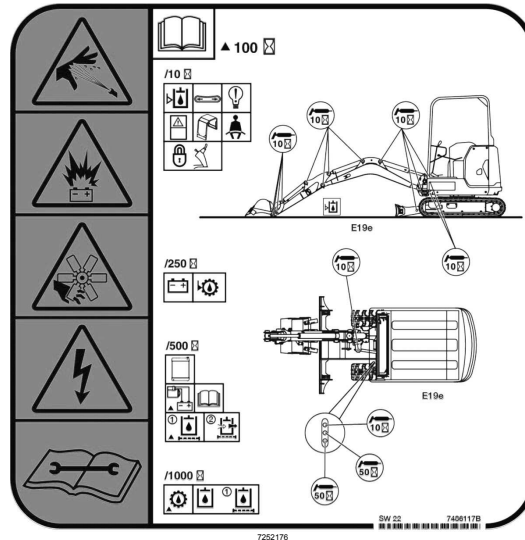

WARNING

INSUFFICIENT INSTRUCTIONS HAZARD







Untrained operators or failure to follow instructions can cause serious injury or death.

- Read and understand the Operation & Maintenance Manual, Operator's Handbook and decals on machine.
- Follow warnings and instructions in the manuals when making repairs, adjustments or servicing.
- Check for correct function after adjustments, repairs or service.

Service Schedule

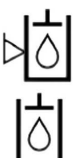
Explanation of the service intervals:

- **10:** Every 10 hours or daily (before starting the machine).
- **50:** Every 50 hours.
- **250:** Every 250 hours or every 12 months, whichever comes first.
- **500:** Every 500 hours or every 12 months, whichever comes first.
- **1000:** Every 1000 hours or every 12 months, whichever comes first.

Service Schedule						
O	Check condition / proper operation. Adjust or replace as needed.	V	Refill as needed.			
D	Check the display. Service only when required.	C	Clean.			
W	Service every 10 hours when operating in water.	R	Replace.			
F	First time only.	G	Grease.			
Item	Service Required	Service Interval (hours)				
		10	50	250	500	1000
Tracks 	Tension	O				
Safety Signs (decals)		C O				
Seat Belt	Seat belt, mounting hardware, and seat belt retractors	C O				
Control Console Lockout		O				
X-Change / Attachment Coupler		O				
Travel Motion Alarm and Horn		O				
Operator Canopy	Canopy, mounting hardware	O				
Display and Lights		O				
Pivot Points 	Pivot points, clamp (if equipped)	G				
Swing Bearing 	Swing bearing, swing pinion	W	G			
Hydraulic System 	Fluid	V				R
Travel Motors (Final Drive) 	Fluid		FR	V		R
Hydraulic System 	Hydraulic filter and case drain filter		FR			R
12 V Auxiliary Battery 	Cables and electrical connections			O		
Hydraulic System 	Breather cap					R