



Bobcat[®]

One Tough Animal.

DIESEL FORKLIFTS

7-Series, Pneumatic, 20 to 25 ton capacity **DV200S-7 / DV250S-7**



ONE TOUGH ANIMAL

OUR MISSION

We empower operators to accomplish more, while working in the toughest conditions and tightest situations. When our customers have the will, we provide the way.

INTRODUCTION



BOBCAT'S HISTORY

In 1958, Melroe Manufacturing Company introduced a compact front-end loader that evolved quickly into the M400, the world's first true skid steer loader. The company soon adopted what became the world-famous 'Bobcat' brand – and its success paved the way for the global compact equipment industry we know today.

YEARS OF EXPERIENCE

In 2021, Bobcat expanded its portfolio by acquiring Doosan Industrial Vehicle. This specialist in material handling equipment constructed its first forklift in 1968 and went on to establish a global presence with 400 dealers in 93 countries.



BOBCAT TODAY

Bobcat is expanding its portfolio with the addition of forklifts and reach trucks for the material handling industry. Offering a comprehensive line-up that will meet all your intralogistics needs. Bobcat forklifts and reach trucks are produced in our factory in Korea, while our premium quality warehouse equipment is made in Germany.



TOUGH, AGILE & SAFE

▶ READY TO GIVE YOUR BUSINESS A LIFT

Give your business a boost with a diesel forklift that ticks all the boxes: a high-performance, powerful, and efficient engine, smooth and variable controls, and a full suite of safety features – all in a machine that's rugged, dependable, and easy to service with a low total cost of ownership.

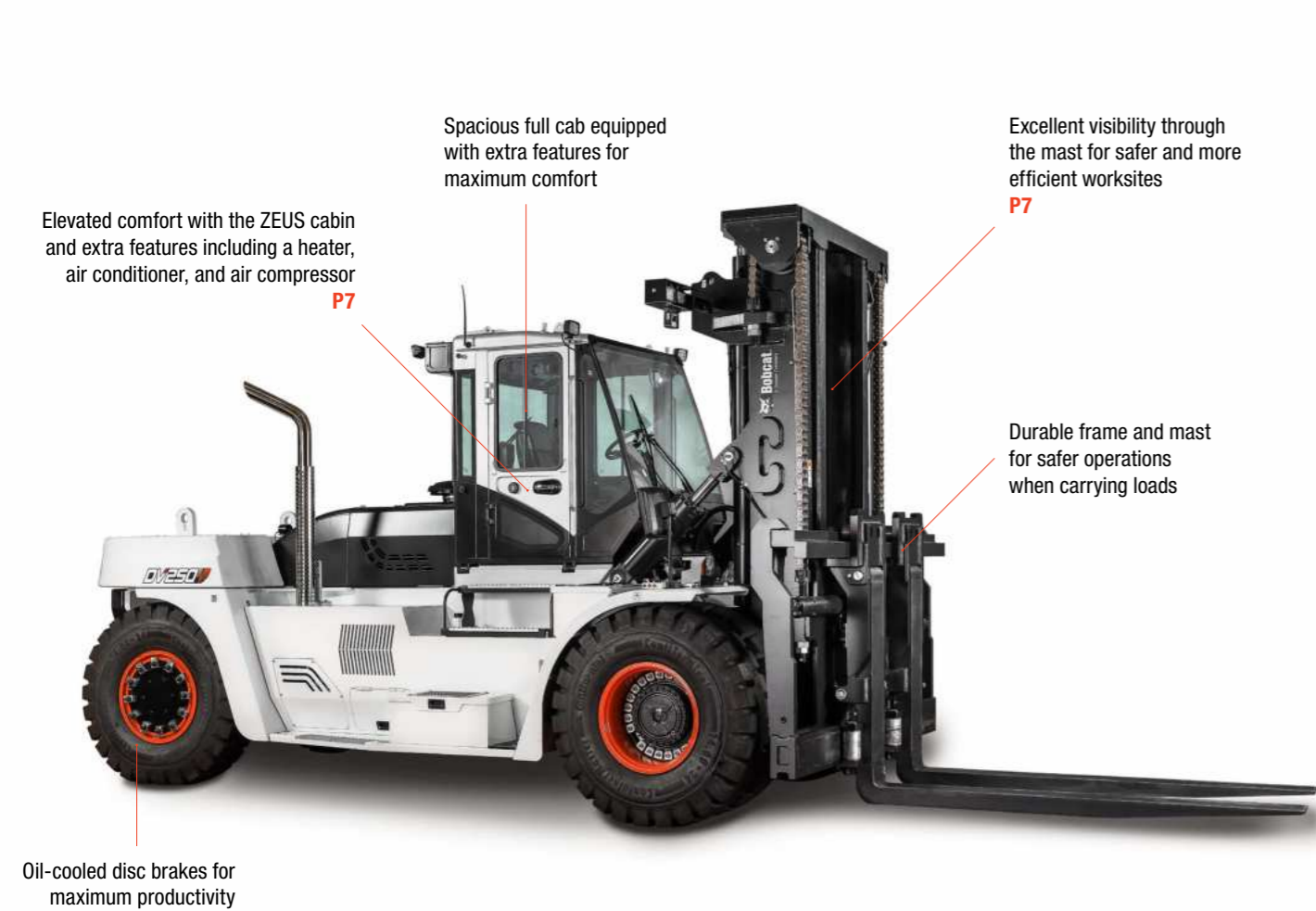

▶ ULTIMATE PRODUCTIVITY

Do more every day, thanks to the high-performance yet efficient engines that offer best-in-class travel and lifting speeds.

P 6-7



▶ ALL-DAY COMFORT

Get through the shift in comfort and with less fatigue with many quality-of-life features as standard including leather suspension seat, colour display, plenty of legroom, anti-slip plate, and more.

P 8-9



▶ DRIVEN BY SAFETY

Enjoy peace of mind provided by the machine's excellent all-around visibility, superb stability, and a full suite of smart sensors.

P 10-11



▶ MAXIMUM UPTIME

Minimise the total cost of ownership with longer service intervals and high-quality, Bobcat genuine parts and consumables which offer excellent value for money and help your machine run smoother and for longer.

P 12-13

OUTSTANDING PRODUCTIVITY



▶ POWERFUL DIESEL ENGINES

Experience the exceptional performance of Doosan engines and reliable components, delivering high-end torque at low engine rpm with reduced fuel consumption.

▶ SUPERB GRADEABILITY AND DRAWBAR PULL

Leveraging the latest engine technology and optimal synchronization between the drive train and hydraulic system, our current models boast high drawbar pull and gradeability.



▶ SUPERIOR HYDROSTATIC STEERING SYSTEM

Transform your material handling with our forklifts, featuring advanced hydrostatic steering. Experience precision and smooth control, boosting efficiency and reducing operator fatigue. Elevate productivity with our innovative steering system.

▶ FINE-TUNED POWERTRAIN

Unleash the power of productivity with our forklift's robust powertrain. Crafted with durable, high-quality components, our powertrain elevates efficiency and performance to propel your business forward.

COMFORT & CONTROLS



▶ EASILY ADJUSTABLE SEAT & COLUMN

The premium air suspension seat provides ample space for the operator with all-day comfort during long shifts. The seat and the steering wheel column are easy to adjust, ensuring every operator feels right at home in the cab.



▶ LUXURIOUS ZEUS CABIN

Experience peak comfort with the ZEUS Cabin. Designed for operator ease, it features accessible switches, ergonomic design, and spacious entry. With low noise, enhanced visibility, and other convenient features such as a heater or air conditioner, this cabin promises optimal comfort.



▶ LARGE IN-CAB DISPLAY

View essential information on your in-cab display's large 5-inch screen. Easily check and control the machine's performance settings with a simple touch for on-the-go convenience.



▶ FRONT AND REAR VIEW CAMERA

Equip your machine with front and/or rear-view cameras that automatically feed to the in-cab display when in forward or reverse mode. This ensures the best view of your workplace without sacrificing comfort.

▶ CENTRALIZED CONTROL



All control switches are arranged in a single location, enhancing the operator's control of the machine.

▶ ELECTRIC INCHING & BRAKING



Maintain high engine revs for hydraulic functions and effortlessly regulate speed with the integrated red button, ensuring a superior driving experience.

▶ MAINTAINING YOUR VISIBILITY



Enjoy even the longest shifts in our ZEUS cabin, equipped with a radio and MP3 player.

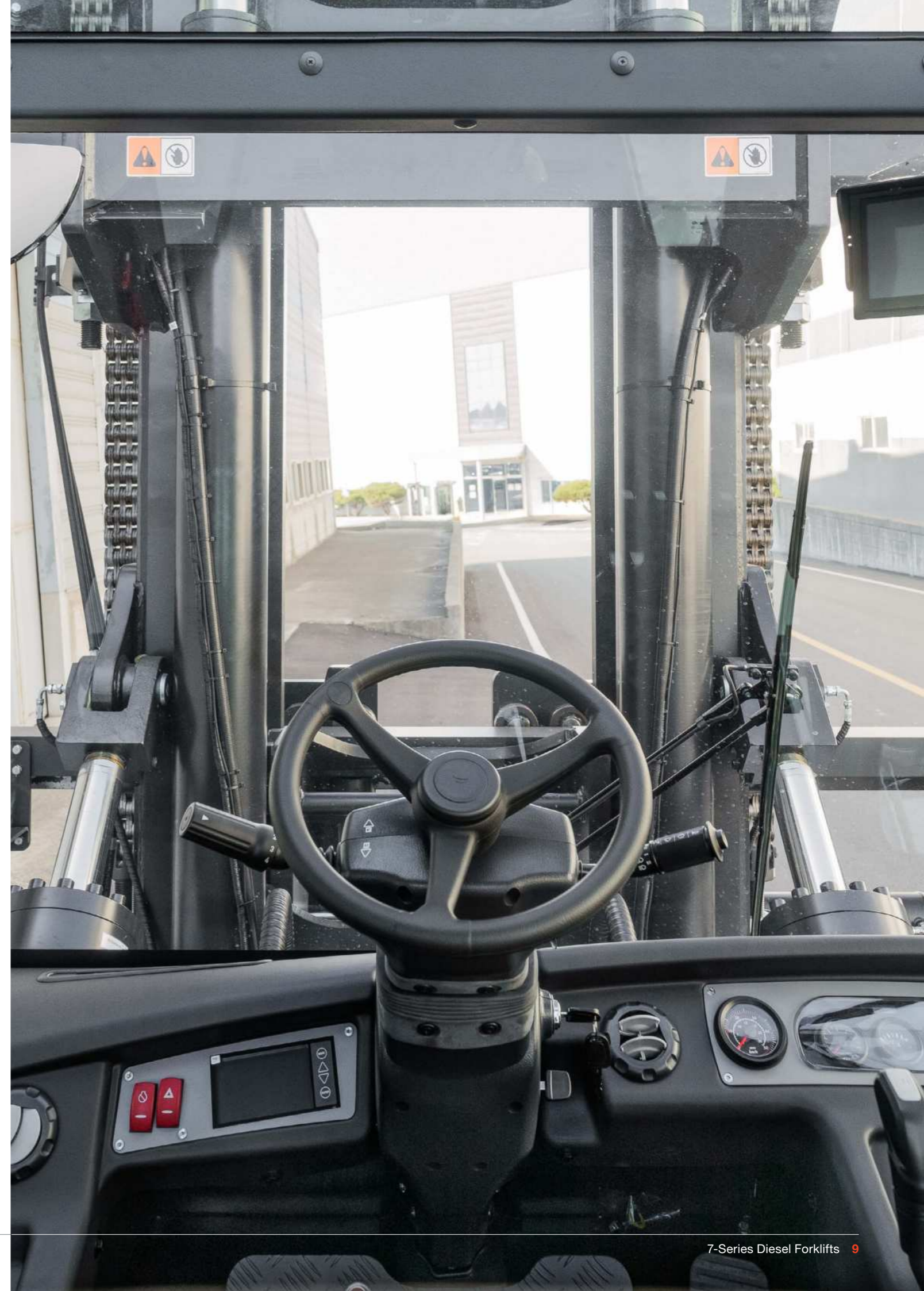

SAFETY IN EVERY MOVE

▶ ADVANCED PROTECTION FOR YOU AND YOUR OPERATION

Bobcat forklifts have safety embedded in their DNA. Packed with tons of features that protect your health and your investment, these machines give you peace of mind in every task, every day.

▶ OPERATOR SENSING SYSTEM (OSS)

The truck's travel and mast lifting functions stop when the operator leaves the seat so the forklift won't perform any unintended movements.

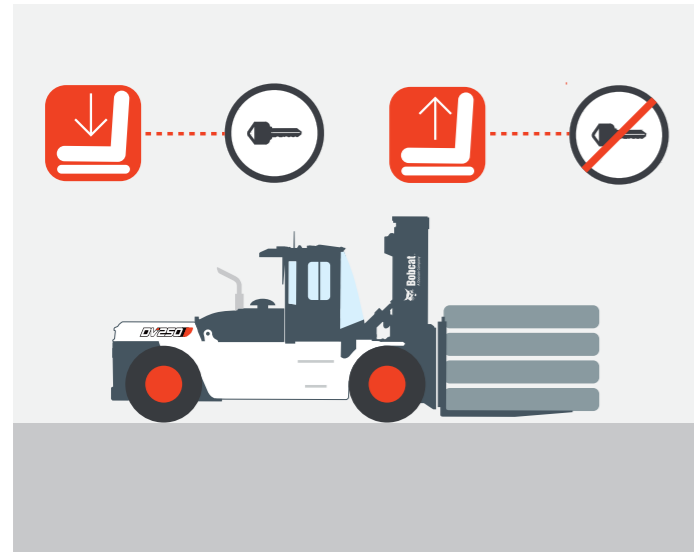

▶ BACKUP ALARM

The backup alarm ensures workplace safety by emitting a warning signal when the operator is driving in reverse, alerting those in the vicinity.



▶ WEIGHT SCALE

With the help of an integrated weight scale, you can prevent overloading your truck to keep operations safe and secure.

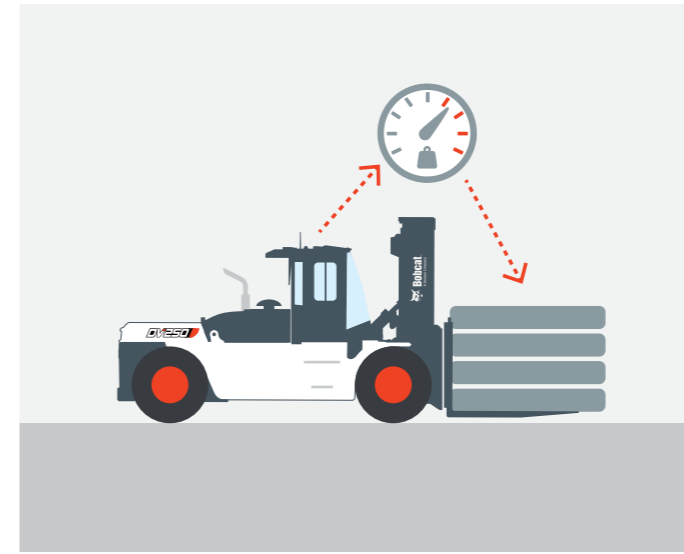

▶ ANTI-SLIP STEP & ENTRY BAR

The anti-slip step ensures comfortable and safe mounting and dismounting of the vehicle, providing additional peace of mind.

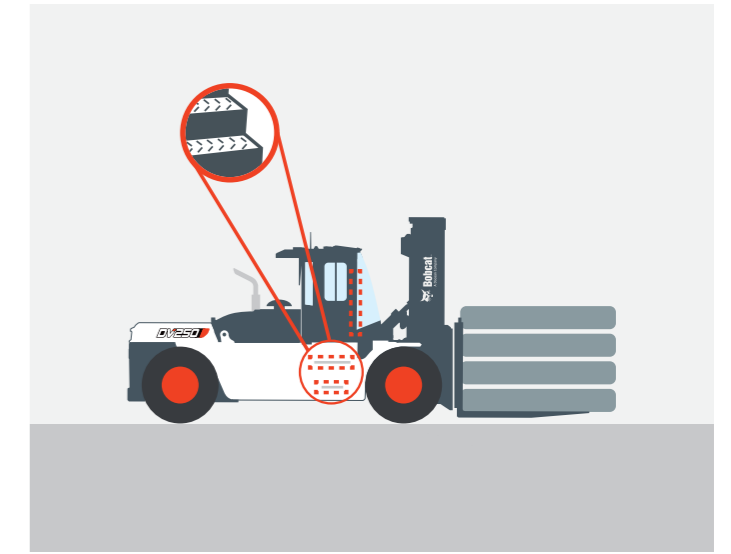

▶ REAR GRAB BAR

Boost your workplace safety with the help of a conveniently placed rear grab bar that will allow you to have a stable point to hold onto when operating the truck in reverse or when maneuvering in tight spaces. It also features a horn button – ready to be pressed with your thumb whenever you need to.



▶ GROUND SPEED CONTROL

To further increase the safety of your truck and workplace you can set up a speed limit that will limit your truck from going too fast. Speed limit can be set separately for forward and reverse directions.



▶ LARGE PANORAMIC AND REAR VIEW MIRROR

The large panoramic and rearview mirrors provide excellent visibility to the rear working area, enhancing safety while contributing to overall productivity.



▶ POWERFUL LED LIGHTS

The LED lights are powerful enough to light up even the darkest places in your workplace so you'll always know all about your surroundings and stay safe.



BUILT TO LAST

▶ EXCELLENT RELIABILITY

Thanks to a powerful engine with auto-shift transmission, full floating drive axle, and shock-absorbing hydrostatic power steering, Bobcat 7-Series Diesel forklifts are built tough to provide you with maximum uptime and dependability.



Automatic tiltable cabin for quick access to well-organized main components

Six roller carriage for superior strength and durability when handling wider and longer loads

A dual-layered radiator and a self-adjusting cooling fan provide exceptional cooling, adjusting based on acceleration

U-joint isolates the powertrain from shock and vibration for fewer engine problems and leaks

Robust frame to withstand the demands of industrial environments and regular heavy use



Oil-cooled disc brakes (ODB) with a lifespan of up to 20 000 hours

Full auto-shift transmission for less wear and tear during operation and directional changes

Dual element air cleaner providing a stream of clean and refreshing cool air to enhance the efficiency of the engine intake system

P11

Full floating drive axle removes the need for mechanical connections between the steering wheel and steer axle, minimizing service calls

THERE'S NO TIME FOR DOWNTIME. STAND UP TO EVERY TASK THAT COMES YOUR WAY. DAY AFTER DAY.



▶ EXTENSIVE DEALER NETWORK

You will receive the best after-sales service from your authorized local or national factory-trained dealer, backed by Bobcat's own customer service center. And Bobcat provides 100% parts inventory to insure any downtime is minimized. When you own a Bobcat forklift, our high quality, responsive customer support team comes with it.

▶ BOBCAT GENUINE PARTS

Quality components delivered to our dealers guarantee that all of our equipment is built to last, withstand the toughest conditions and provide reliable performance.

MAIN SPECIFICATIONS

TECHNICAL DATA ACCORDING TO VDI 2198				
		DV200 (TIER III)	DV250S-7 (TIER III)	DV250S-7 (TIER IV)
Emission regulation		Tier III		Tier IV
Capacity at rated load center (kg)	Q	20 000		25 000
Load center (mm)	c	900		1 200
Load distance: center of drive axle to fork (mm)	x	1 000		1 120
Wheel base (mm)	y	3 750		4 250
Service weight unloaded (kg)		25 838	38 150	38 500
Tread width front (mm)	b10	1 858		2 200
Tread width rear (mm)	b11	1 976		2 140
Tilt mast / fork carriage forward / backward (°)	α/β	10 / 9		12 / 10
Height, mast lowered (mm)	h1	3 235 – 4 235	3 400 – 4 650	3 600 – 4 650
Free lift (mm)	h2	0		0 – 1 890
Maximum fork height (mm)	h3	3 000 – 5 000		3 500 – 5 600
Height, mast extended (mm)	h4	7 420		7 430
Height of over overhead guard (mm)	h6	2 930		3 310
Length to fork face (mm)	l2	5 580		6 350
Overall width (mm)	b1	2 540		3 050
Ground clearance loaded, at the lowest point (mm)	m1	210		290
Ground clearance loaded, center of wheel base (mm)	m2	325		380
Turning radius (mm)	Wa	5 120		5 950
Travel speed loaded / unloaded (km/h)		32 / 38	23 / 28	37 / 40
Lift speed loaded / unloaded (m/s)		38 / 41		31 / 34
Lowering speed loaded / unloaded (m/s)			40 / 35	
Drawbar pull loaded, at 1.6 km/h (kg)		14 528	22 240	23 516
Gradeability loaded (%)		31	34.6	36
Engine manufacturer/type		HDI DL08		HDI DL08P
Engine power according to DIN ISO1585 (kW/rpm)		189.8 / 2 100	217 / 2 100	213.3 / 2 100
Rated speed (min ⁻¹)			2 100	
Torque at 1/min (kgfm/rpm)		102 / 1400	114 / 1400	114 / 1 400
Cylinders/cycle/displacement (cc)			6 / 4 / 7 640	

Specification values quoted in this specification sheet have been rounded. Performance may vary depending on operating conditions. Products and specifications are subject to improvement and change without prior notice.

(1) Mast dimensions refer to a range from the lowest to highest available mast with load backrest

Note: Load capacities are based on the standard chassis without side shifter.

STANDARD EQUIPMENT & OPTIONS

STANDARD EQUIPMENT & OPTIONS		
	DV200 / 250S-7 (TIER III)	DV250S-7 (TIER IV)
PRODUCTIVITY		
Powerful engine complied with Euro stage III	✓	–
Powerful engine complied with Euro stage IV	–	✓
All in one electronic brake and inching pedal	✓	✓
Power steering	✓	✓
Pedal location (accelerator, brake and inching)	✓	✓
Air compressor	•	•
RELIABILITY		
Oil-cooled Disc Brakes (ODB)	✓	✓
Dual element air cleaner	✓	✓
Precleaner	✓	✓
Full autoshift transmission	✓	✓
Rigid driveaxle	✓	✓
Waterproof connectors	✓	✓
Engine guard	–	•
Reverse fan	–	•
SAFETY		
Parking brake	✓	✓
Operator Sensing System (OSS)	✓	✓
Back-up alarm	✓	✓
Front (2) and rear (2) work LED lights	✓	✓
Additional four lights on mast	–	✓
Rear view mirror	✓	✓
Rear grab bar with horn	–	✓
Strobe light	•	•
Rear (and front) view camera (with steering angle sensor)	–	•
Siren and microphone	•	•
Ground speed control	–	•
Heated side mirrors	•	•
Weight scale	•	•

STANDARD EQUIPMENT & OPTIONS		
	DV200 / 250S-7 (TIER III)	DV250S-7 (TIER IV)
ERGONOMICS		
Integrated Instrument panel	✓	✓
Suspended leather seat	✓	✓
Grammer extra suspension seat	–	•
Overhead guard	✓	•
Telescopic and tilt steering column	✓	✓
Tool kit	✓	✓
Steering wheel knob	✓	✓
Emergency switch	✓	✓
Back up buzzer	✓	✓
Full ZEUS cabin, includes: rear view mirrors, low noise level, automatic tiltable, wipers, MP3 player, sun visor)	•	•
Heater	•	•
Operator fan	•	•
Air conditioner with rear condensor	•	•
SERVICEABILITY		
Tiltable operator compartment	✓	✓
Easy view	✓	✓
Centralized hydraulic measuring gauge ports	✓	✓
Grease injector	✓	✓
Wide hood open range	✓	✓

*This list is based on factory data. Standard or optional can vary for specific countries.

• = option
 ✓ = standard
 – = not available

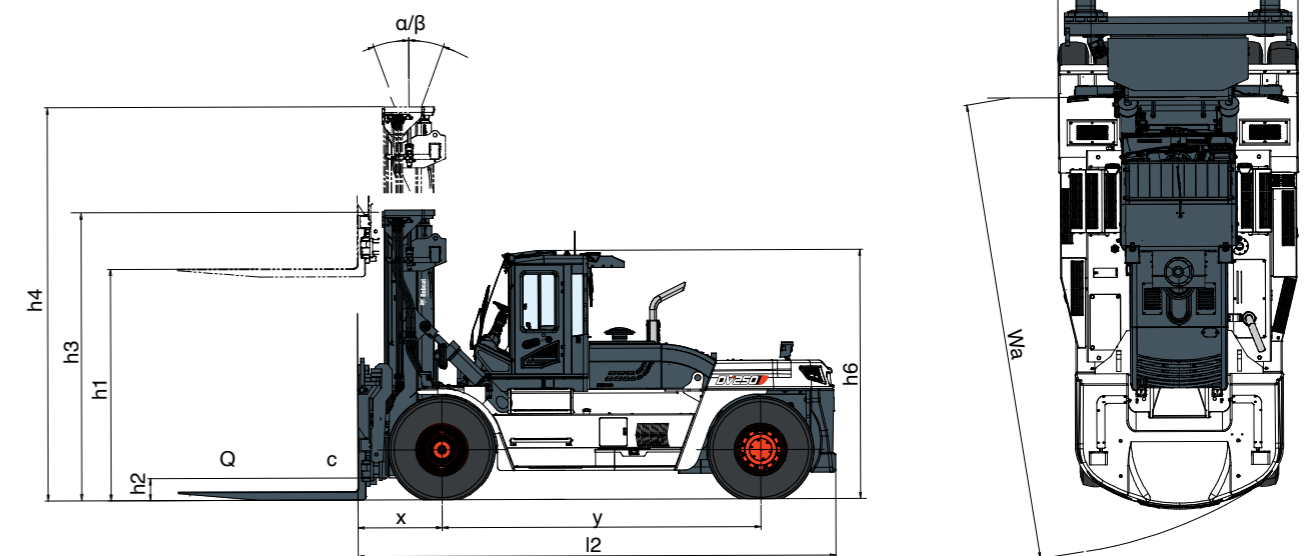

YOUR TRUSTED BUSINESS PARTNER

Your machine builds your business and reputation. Everything we put into Bobcat equipment is designed to make this possible. Strength, versatility, or agility, it's built around you.



340 MACHINES / 150 ATTACHMENT FAMILIES / 1 TOUGH ANIMAL



SKID-STEER LOADERS



COMPACT TRACK LOADERS



BACKHOE LOADERS

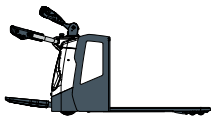

WAREHOUSE EQUIPMENT



FORKLIFTS

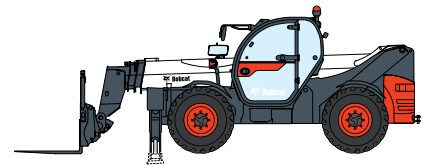

TELEHANDLERS



LIGHT COMPACTION EQUIPMENT

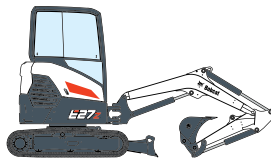

COMPACT EXCAVATORS



SMALL ARTICULATED LOADERS



MINI TRACK LOADER

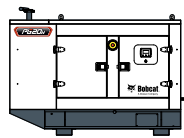

PORTABLE GENERATORS



AIR COMPRESSORS

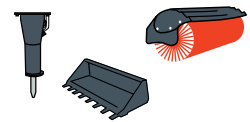

ATTACHMENTS

DOOSAN

Bobcat is a Doosan Company. Doosan is a global leader in construction equipment, power & water solutions, engines, and engineering proudly serving customers and communities for more than a century. | Bobcat and the Bobcat logo are registered trademarks of Bobcat Company in the United States and various other countries. ©2024 Bobcat Company. All Rights Reserved.

Doosan Bobcat Korea Co., Ltd.

www.bobcat.com

©2024 BOBCAT



Bobcat®