

# **72558, 72559, 72560**

## **Halogen to LED Plow Light Update Kits**

### **Parts List and Installation Instructions**

**▲ CAUTION**

Read this document before installing the harness kit.

**▲ CAUTION**

See your sales outlet/website for specific vehicle application recommendations before installation. The online selection system has specific vehicle and snowplow requirements.

**PARTS LIST**

LED Plow Light Kits				
Part	Description	Qty		
		Plow	Vehicle	Plow & Vehicle
		72559	72558	72560
39901	LED Headlamp (DS)	1		1
39902	LED Headlamp (PS)	1		1
72546	Vehicle Lighting Harness – 16-Pin, LED		1	1
72548	Harness Assembly – Plow Lighting – 16-Pin, LED	1		1
72565	Headlamp Control Module (HCM)		1	1
72550	Cable Assembly – HCM		1	1
72552	Wire Assembly – EdgeView™ Lights	1		1
72643	Adapter, Dual-Wire, HCM – 10-Pin		1	1
72512	Cover, LED Harness Connector (pkg of 2)	1		1
72463	Cable Boot	1		1
69915	Plug Cover		1	1
–	Reclosable Fasteners		4	4
–	Cable Tie, 15", Black	10	10	10

## SAFETY DEFINITIONS

### WARNING

Indicates a potentially hazardous situation that, if not avoided, could result in death or serious personal injury.

### CAUTION

Indicates a potentially hazardous situation that, if not avoided, may result in minor or moderate injury. It may also be used to alert against unsafe practices.

**NOTE:** Indicates a situation or action that can lead to damage to your snowplow and vehicle or other property. Other useful information can also be described.

## FUSES

The snowplow electrical and hydraulic systems contain several automotive-style fuses. If a problem should occur and fuse replacement is necessary, the replacement fuse must be of the same type and amperage rating as the original. Installing a fuse with a higher rating can damage the system and could start a fire. Fuse Replacement, including fuse ratings and locations, is located in the Maintenance section of the Owner's Manual.

## BATTERY SAFETY

### CAUTION









Batteries normally produce explosive gases, which can cause personal injury. Therefore, do not allow flames, sparks, or lit tobacco to come near the battery. When charging or working near a battery, always cover your face and protect your eyes, and also provide ventilation.

- Batteries contain sulfuric acid, which burns skin, eyes, and clothing.
- Disconnect the battery before removing or replacing any electrical components.

## TORQUE CHART

### CAUTION

Read instructions before assembling. Fasteners should be finger tight until instructed to tighten according to the torque chart. Use standard methods and practices when attaching snowplow, including proper personal protective safety equipment.

Recommended Fastener Torque Chart					
Inch Fasteners Grade 5 and Grade 8					
Size	Torque (ft-lb)		Size	Torque (ft-lb)	
	 Grade 5	 Grade 8		 Grade 5	 Grade 8
1/4-20	8.4	11.9	9/16-12	109	154
1/4-28	9.7	13.7	9/16-18	121	171
5/16-18	17.4	24.6	5/8-11	150	212
5/16-24	19.2	27.3	5/8-18	170	240
3/8-16	30.8	43.6	3/4-10	269	376
3/8-24	35.0	49.4	3/4-16	297	420
7/16-14	49.4	69.8	7/8-9	429	606
7/16-20	55.2	77.9	7/8-14	474	669
1/2-13	75.3	106.4	1-8	644	909
1/2-20	85.0	120.0	1-12	704	995
Metric Fasteners Class 8.8 and 10.9					
Size	Torque (ft-lb)		Size	Torque (ft-lb)	
	 Class 8.8	 Class 10.9		 Class 8.8	 Class 10.9
M6 x 1.00	7.7	11.1	M20 x 2.50	325	450
M8 x 1.25	19.5	26.9	M22 x 2.50	428	613
M10 x 1.50	38.5	53.3	M24 x 3.00	562	778
M12 x 1.75	67	93	M27 x 3.00	796	1139
M14 x 2.00	107	148	M30 x 3.50	1117	1545
M16 x 2.00	167	231	M33 x 3.50	1468	2101
M18 x 2.50	222	318	M36 x 4.00	1952	2701
These torque values apply to fasteners except those noted in the instructions.					

## INSTALLATION INSTRUCTIONS

*For tractor applications, vehicle-side wiring instructions are packed in the Tractor Harness Kit (PN 74170).* After completing those instructions, skip to the LED Headlamp Hardware Installation Instructions on Page 10 of this document.

### LED Plow Light Vehicle-Side Dual Wire Installation

**NOTE:** Prior to installing the vehicle-side LED wiring, confirm that the previously installed halogen plow lighting vehicle-side wiring is functioning correctly.

### Headlamp Control Module (HCM) Mounting

Locate a flat surface within the engine compartment of the vehicle near the isolation module. The fire wall, fender well, or radiator shroud are possible mounting locations. If a suitable flat surface is not accessible, cable tie the HCM to existing brackets or harnessing.

Mount the HCM so that the harness connections are wire side down.

**NOTE:** If possible, mount the HCM in an area that is protected from road splash.

Reclosable fastener strips and/or cable ties are supplied for mounting the HCM. When using reclosable fastener strips, the mounting surface must be free of dirt and grease.

Headlamp Control Module  
(bottom view)

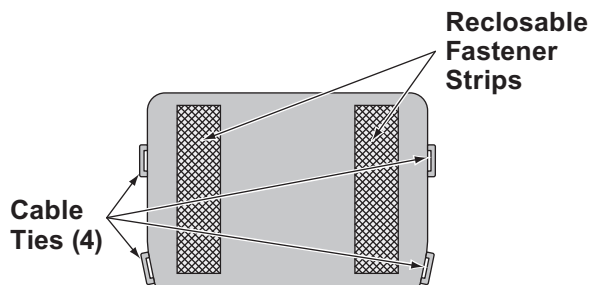

### HCM Vehicle Battery Cable Installation

#### ⚠ CAUTION

Batteries normally produce explosive gases, which can cause personal injury. Therefore, do not allow flames, sparks, or lit tobacco to come near the battery. When charging or working near a battery, always cover your face and protect your eyes, and also provide ventilation.

- Batteries contain sulfuric acid, which burns skin, eyes, and clothing.
- Disconnect the battery before removing or replacing any electrical components.

**NOTE:** When instructed, make all snowplow battery cable connections to the auxiliary battery, if vehicle is so equipped.

**NOTE:** Use dielectric grease on all electrical connections to prevent corrosion. Fill receptacles and lightly coat ring terminals before assembly.

1. Turn OFF the vehicle ignition.
2. Disconnect both the NEGATIVE (–) and the POSITIVE (+) battery cables from the vehicle battery.
3. Route the supplied HCM vehicle battery cable from the battery to the 2-position mating connector on the HCM vehicle lighting harness, avoiding any sharp edges and hot or moving parts.

## HCM Vehicle Lighting Harness Installation

1. Route harnesses around or through the radiator bulkhead to the HCM.
2. Make the following connections:
  - 2-position connector from the vehicle lighting harness to the matching 2-position connector from the vehicle cable assembly
  - Vehicle lighting harness to position "Y" on the HCM.

---

**NOTE: Single-pin connector from the LED vehicle lighting harness will not be required on a dual-wire system.**

---

3. Route the red wire from the vehicle lighting harness to the stud on the HCM.
4. Remove the protective plastic domed nut and the top brass nut from the HCM stud. Install the red wire ring terminal on the stud and remaining brass nut. Reinstall the top brass nut and tighten to 25.9 in-lb. Reinstall the protective plastic domed nut. (See illustration below.)

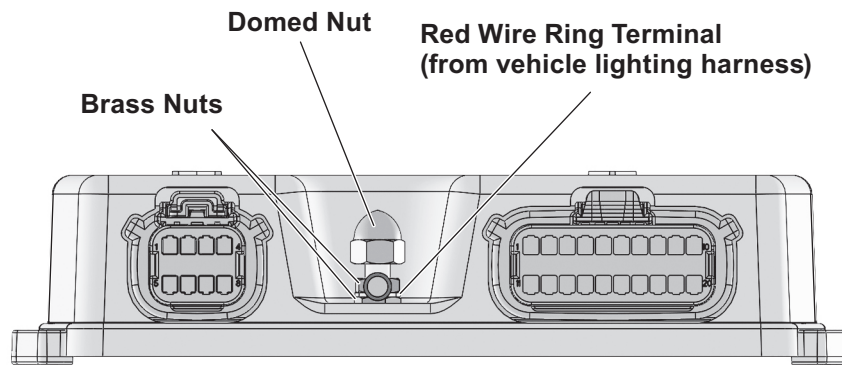

**Headlamp Control Module (HCM)**

## PLUG COVER INSTALLATION

Stretch the rectangular opening of the plug cover strap over the end of the HCM vehicle lighting harness. Place the plug cover over the molded plug whenever the snowplow is not in use.

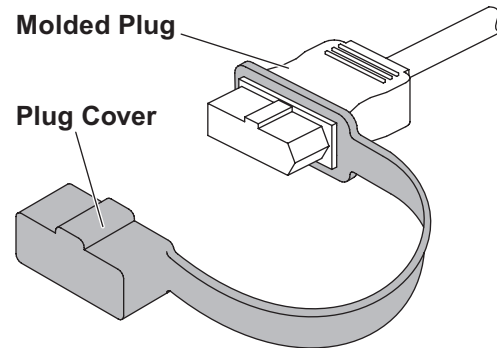

**TYPICAL LED PLOW LIGHT, HEADLAMP CONTROL MODULE (HCM), AND HARNESS DIAGRAM**

\* NOTE: Not all ground wire connections are to the NEGATIVE (-) battery terminal. Some applications require NEGATIVE (-) cables to be connected to the vehicle chassis grounding stud. Refer to your Harness Kit 3-Port Isolation Module Light System Installation Instructions for the proper battery connections for your specific vehicle application.

NOTE: Plug covers shall be used whenever snowplow is disconnected.

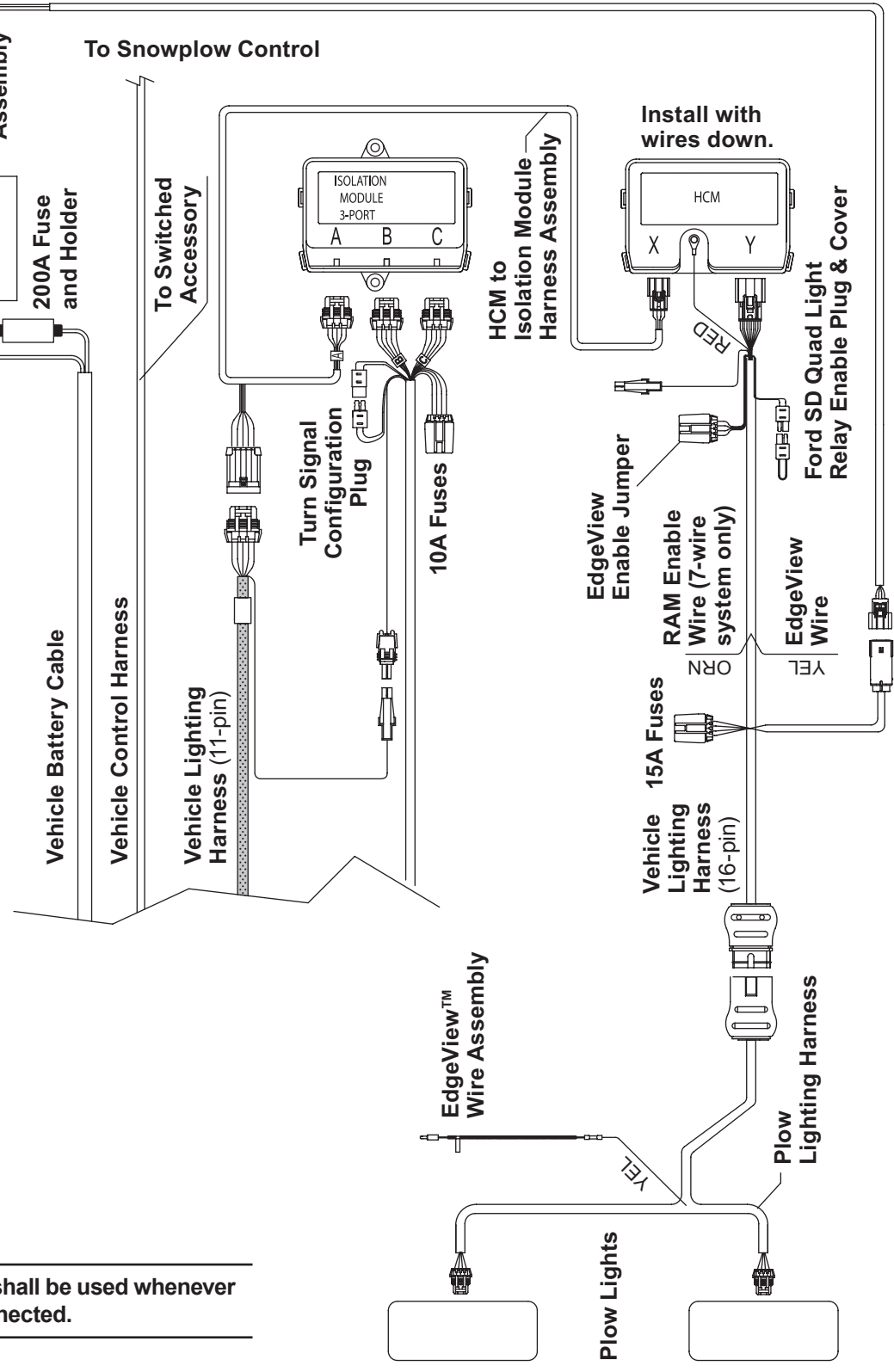

**TYPICAL RAM 7-WIRE SYSTEM'S LED PLOW LIGHT, HEADLAMP CONTROL MODULE (HCM), AND HARNESS DIAGRAM**

\* NOTE: Not all ground wire connections are to the NEGATIVE (-) battery terminal. Some applications require NEGATIVE (-) cables to be connected to the vehicle chassis grounding stud. Refer to your Harness Kit 3-Port Isolation Module Light System Installation Instructions for the proper battery connections for your specific vehicle application.

NOTE: Plug covers shall be used whenever snowplow is disconnected.

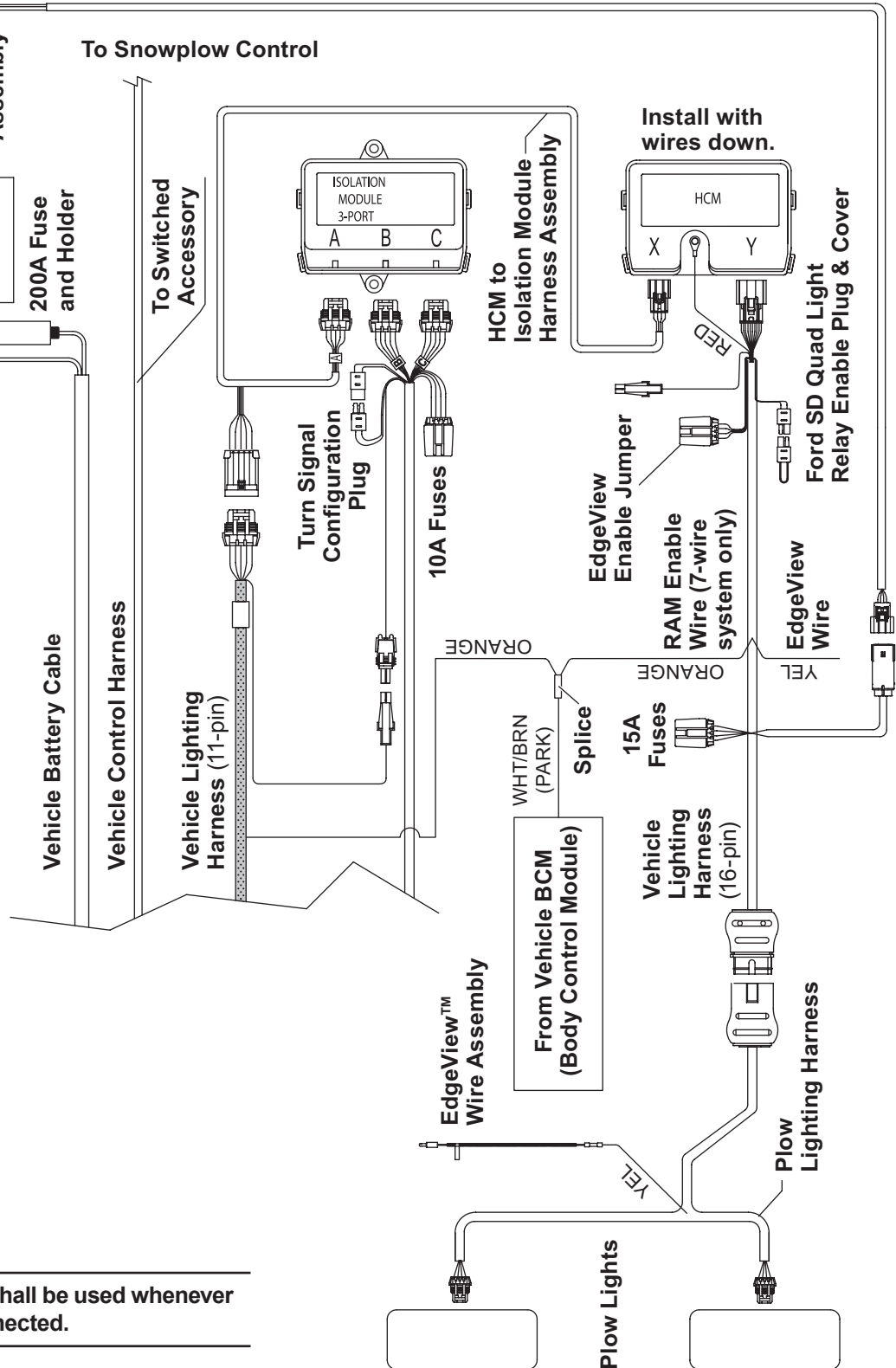

## HCM TO ISOLATION MODULE HARNESS INSTALLATION

---

**NOTE:** Ford Super Duty: 2-pin relay enable plug on the LED vehicle lighting harness will not be required on dual-wired vehicles.

---

**NOTE:** RAM 7-Wire System: Orange wire on the LED vehicle lighting harness will need to be connected to the orange and WHT/BRN wires on the original halogen system wiring.

---

1. Remove the 10-pin connector from port A of the isolation module.
2. Make the following connections:
  - 10-pin connector from the dual-wire harness into port A on the isolation module
  - 10-pin connector that was removed from port A of the isolation module into the mating 10-pin connector on the dual-wire harness
  - 8-position connector to port X of the HCM.
3. Cable tie harnesses as needed, away from any sharp, hot, or moving parts.

## BATTERY CONNECTIONS

---

**NOTE:** Cable tie cable assemblies and control and lighting harnesses away from any sharp edges and hot or moving parts.

---

**NOTE:** Follow OEM battery cable connection recommendations when attaching to the battery.

---

Battery connections vary depending on your application. Refer to your Harness Kit 3-Port Isolation Module Light System Installation Instructions for the proper battery connections for your specific vehicle application.

---

**NOTE:** Not all ground wire connections are to the **NEGATIVE (-) battery terminal**. Some applications require **NEGATIVE (-) cables to be connected to the vehicle chassis grounding stud**.

---



## CHANGING BLADE-EDGE ILLUMINATION MODE

On snowplows equipped with LED headlamps, the EdgeView™ technology feature offers three modes for blade-edge illumination. The factory default setting is ON.

To change the blade-edge illumination mode, remove the cover from the fuse holder located near the "Y" port of the headlamp control module installed in the vehicle engine compartment.

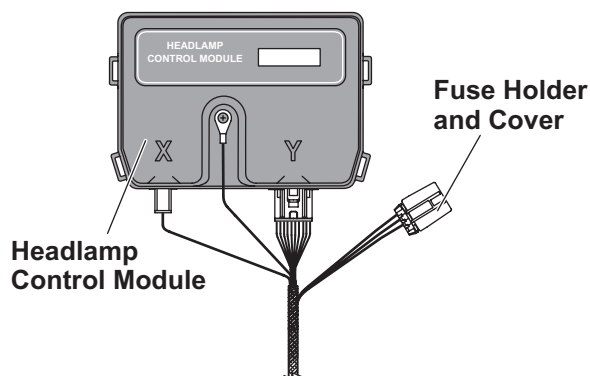

Remove the jumper fuse from the fuse holder and re-insert it in the desired mode position as shown below. Replace the fuse holder cover.

**Default – ON:**  
Blade edge lights illuminate when plow has power.

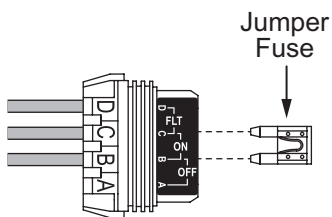

**FLT:** Blade edge lights illuminate when blade is in FLOAT mode.

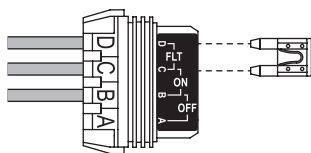

**OFF:** Blade edge lights disabled.

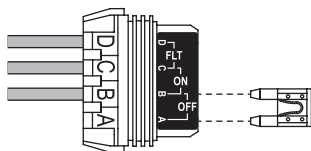

## PLOW-SIDE EdgeView LIGHTING CONNECTIONS

The EdgeView Float (FLT) mode activation function will require a second plow-side electrical connection.

1. On the plow-side LED lighting harness, locate the yellow wire cable tied to the body of the harness near the "Y" section.
2. Strip the end of the yellow wire and insert stripped wire end into the pre-installed insulated butt connector on the supplied EdgeView wire assembly.
3. Crimp the connection and heat seal the insulated splice.
4. Remove the plow hydraulic unit cover. Route the EdgeView wire assembly along the plow structure to the plow hydraulic unit, and cable tie wires as needed.
5. Locate the solenoid on the plow hydraulic unit that is activated during the plow Lower/Float function. Refer to the Mechanic's Guide or snowplow manufacturer's website for further information.
6. Plug the bullet terminal on the end of the supplied EdgeView wire assembly into the receptacle on the corresponding solenoid wire. If a receptacle is not found on the correct solenoid wire, remove the bullet terminal from the EdgeView wire assembly and splice the end of the EdgeView wire into the correct solenoid wire.
7. Cable tie extra wire length to the snowplow assembly and reinstall the hydraulic unit covers.

**NOTE: EdgeView light will turn ON or OFF approximately 5 seconds after EdgeView Mode is activated or canceled.**

## LED HEADLAMP HARDWARE INSTALLATION INSTRUCTIONS

**⚠ CAUTION**

Read this document before installing the LED headlamp hardware mounting kit.

**⚠ CAUTION**

Use standard methods and practices when attaching snowplow and installing accessories, including proper personal protective safety equipment.

1. Park the vehicle on a smooth, level, hard surface, such as concrete. Lower the blade to the ground, and turn the control OFF. Disconnect the snowplow from the vehicle, or turn the vehicle ignition to the "OFF" position and remove the key.
2. Place a headlamp swivel on the light bar, aligning it with the headlamp attachment points.
3. Insert the two headlamp posts through the two holes in the swivel and light bar. Make sure to install the headlamp on the correct end of the light bar (i.e., passenger-side headlamp on the passenger's side of the bar).

4. On the headlamp post passing through the slot, install a 1/2" rubber washer, 1/2" flat washer, 1/2" lock washer, and 1/2" hex nut (in that order) and hand tighten.

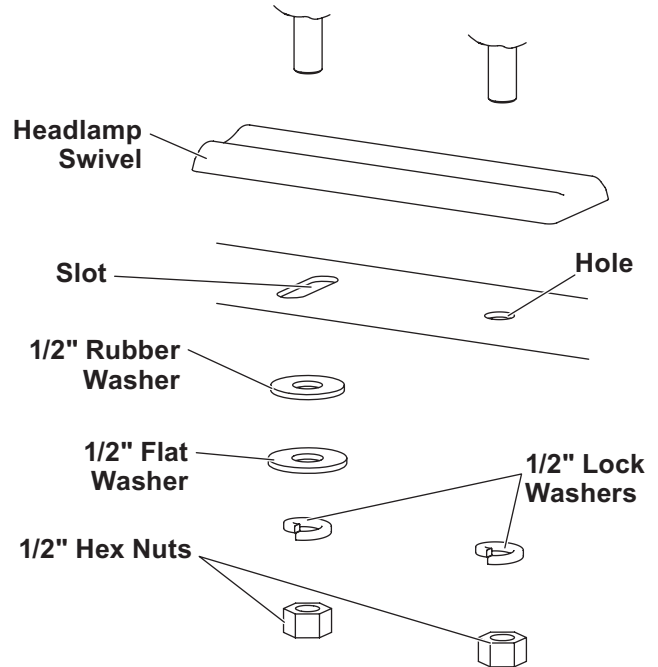

5. On the headlamp post passing through the hole, install a 1/2" lock washer and 1/2" hex nut. Hand tighten the fasteners.

6. Follow the Snowplow Headlamp Beam Aiming Instructions (Lit. No. 27769) to achieve the correct visual aim. Once the headlamps are correctly aimed, tighten the headlamp fasteners to 22 ft-lb (30 N·m).
7. If not already assembled, form the two halves of the harness plug guard around the end of the harness and secure with cable ties. Tighten and trim the ends.

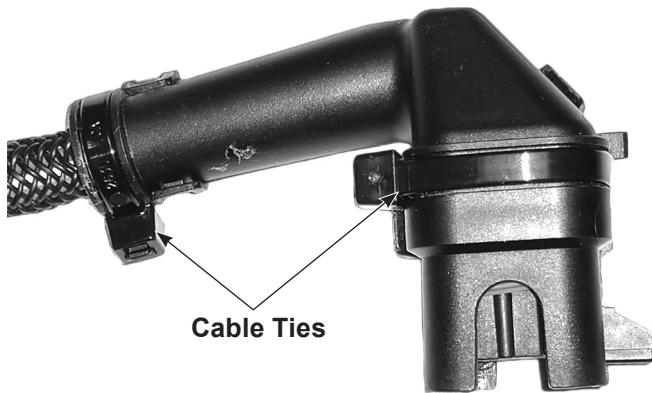

10. Pass the harness over the cable tie and secure. Tighten and trim the ends.



8. Attach the harness to the rear of the headlamp.
9. Insert a cable tie in the anchor hole in the back of the headlamp.

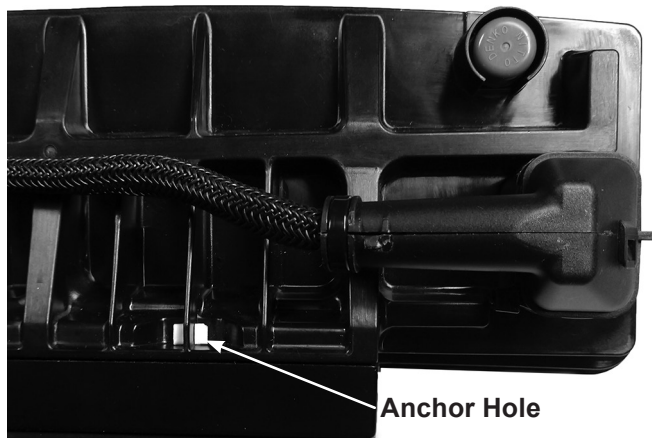

## RECOMMENDED SPLICING PROCEDURE

1. Locate the wire to be spliced into.
2. Cut the wire at least 1-1/2" from any other splice, connector, or terminal. If wires are covered by tubing or braid, remove enough of it to achieve the minimum clearance required.
3. Strip away 5/16" of insulation from the ends of the wires to be spliced.
4. Slide two wires into one end of the supplied parallel splice.
5. Place a piece of heatshrink tubing (3/16" x 1-1/4" long) over the remaining wire to be spliced. Cut tubing into 1-1/4" lengths if required.
6. Insert the wire into the open end of the splice and crimp using an appropriate crimp tool. One or two crimps may be necessary to ensure a good connection. No wire strands should be visible outside of the splice.
7. Preheat a soldering tool for at least one minute to help promote even solder flow.
8. Apply heat to the splice. Avoid heating too close to the insulation. Apply solder to the wires. Use just enough solder to produce an even flow through the splice. **Use rosin core solder ONLY. Do not use acid core solder.**

**NOTE: Avoid using an excessive amount of solder, as it can result in wicking. Wicking occurs when solder travels up the wire core. This may cause the wire to become stiff or brittle, which could lead to a broken or open circuit.**

9. Check the circuits for continuity.
10. Cover the splice with heatshrink tubing. The tubing should extend beyond the splice on both sides.
11. Using a hot air source, starting in the center and working out to either side, apply heat until the tubing recovers and glue can be seen around the edges. Allow the tubing to cool before handling.

**NOTE: The splices supplied will accommodate 18-gauge wires as shown. For larger gauge wires, cut the wire, strip the ends 3/8" to 1/2", and twist together. Apply solder to the splice and cover with heatshrink tubing.**

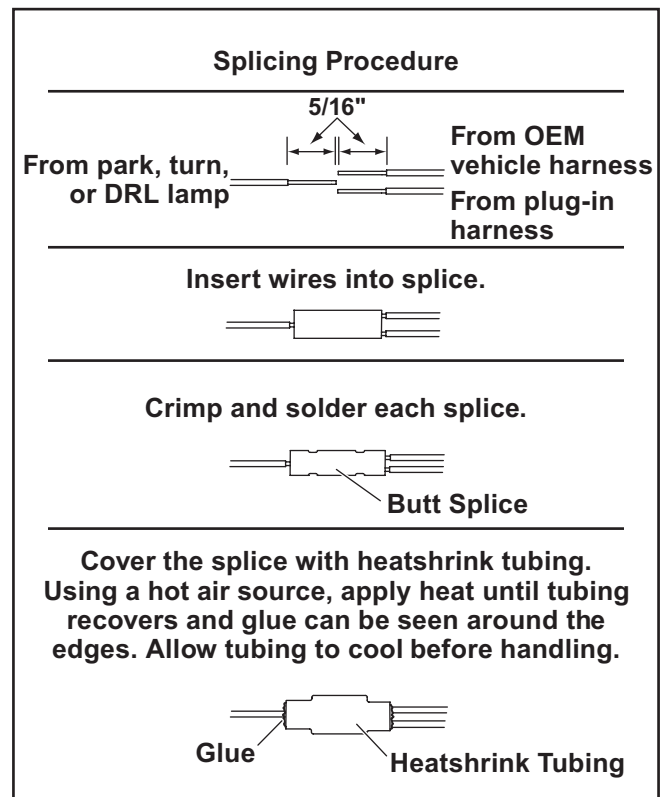

Copyright © 2024 Douglas Dynamics, LLC. All rights reserved. This material may not be reproduced or copied, in whole or in part, in any printed, mechanical, electronic, film, or other distribution and storage media, without the written consent of the company. Authorization to photocopy items for internal or personal use by the company's outlets or snowplow owner is granted.

The company reserves the right under its product improvement policy to change construction or design details and furnish equipment when so altered without reference to illustrations or specifications used. This equipment manufacturer or the vehicle manufacturer may require or recommend optional equipment for snow removal. Do not exceed vehicle ratings with a snowplow. The company offers a limited warranty for all snowplows and accessories. See separately printed page for this important information. The following is an unregistered (™) trademark of Douglas Dynamics, LLC: EdgeView™.