

33888

MOUNT KIT

Ram 2500/3500

2019—__

Installation Instructions

▲ CAUTION

Read this document before installing the snowplow.

▲ CAUTION

See your sales outlet/website for specific vehicle application recommendations before installation. The online selection system has specific vehicle and snowplow requirements.

SAFETY DEFINITIONS

⚠ WARNING
 Indicates a potentially hazardous situation that, if not avoided, could result in death or serious personal injury.

⚠ CAUTION
 Indicates a potentially hazardous situation that, if not avoided, may result in minor or moderate injury. It may also be used to alert against unsafe practices.

NOTE: Indicates a situation or action that can lead to damage to your snowplow and vehicle or other property. Other useful information can also be described.

WARNING/CAUTION & INSTRUCTION LABELS

Become familiar with and inform users about the warning labels on the back of the blade and the instruction label on the headgear.

NOTE: If labels are missing or cannot be read, see your sales outlet.

Warning/Caution Label

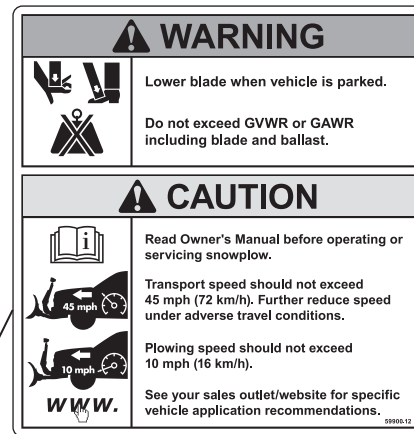

Instruction Label

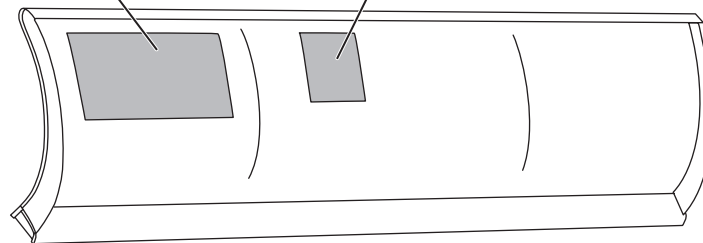

SAFETY PRECAUTIONS

Improper installation and operation could cause personal injury and/or equipment and property damage. Read and understand labels and the Owner's Manual before installing, operating, or making adjustments.

⚠ WARNING

Lower the blade when vehicle is parked. Temperature changes could change hydraulic pressure, causing the blade to drop unexpectedly or damaging hydraulic components. Failure to do this could result in serious personal injury.

⚠ WARNING

The driver shall keep bystanders clear of the blade when it is being raised, lowered, or angled. Do not stand between vehicle and blade or within 8 feet of a moving blade. A moving or falling blade could cause personal injury.

⚠ WARNING

Keep hands and feet clear of the blade and A-frame when mounting or removing the snowplow. Moving or falling assemblies could cause personal injury.

⚠ WARNING

Do not exceed GVWR or GAWR including the blade and ballast. The rating label is found on the driver-side vehicle door cornerpost.

⚠ WARNING

To prevent accidental movement of the blade, always turn the control OFF whenever the snowplow is not in use. The power indicator light will turn OFF.

⚠ WARNING

Remove blade assembly before placing vehicle on hoist.

⚠ CAUTION

Refer to the eMatch tool for minimum vehicle recommendations and ballast requirements.

PERSONAL SAFETY

- Remove ignition key and put the vehicle in PARK or in gear to prevent others from starting the vehicle during installation or service.
- Wear only snug-fitting clothing while working on your vehicle or snowplow.
- Do not wear jewelry or a necktie, and secure long hair.
- Wear safety goggles to protect your eyes from battery acid, gasoline, dirt, and dust.
- Avoid touching hot surfaces such as the engine, radiator, hoses, and exhaust pipes.
- Always have a fire extinguisher rated BC handy, for flammable liquids and electrical fires.

⚠ WARNING

Gasoline is highly flammable and gasoline vapor is explosive. Never smoke while working on vehicle. Keep all open flames away from gasoline tank and lines. Wipe up any spilled gasoline immediately.

FIRE AND EXPLOSION

Be careful when using gasoline. Do not use gasoline to clean parts. Store only in approved containers away from sources of heat or flame.

CELL PHONES

A driver's first responsibility is the safe operation of the vehicle. The most important thing you can do to prevent a crash is to avoid distractions and pay attention to the road. Wait until it is safe to operate mobile communication equipment such as cell phones, text messaging devices, pagers, or two-way radios.

VENTILATION

⚠ WARNING

Vehicle exhaust contains lethal fumes. Breathing these fumes, even in low concentrations, can cause death. Never operate a vehicle in an enclosed area without venting exhaust to the outside.

NOISE

Airborne noise emission during use is below 70 dB(A) for the snowplow operator.









VIBRATION

Operating snowplow vibration does not exceed 2.5 m/s² to the hand-arm or 0.5 m/s² to the whole body.

TORQUE CHART

⚠ CAUTION

Read instructions before assembling. Fasteners should be finger tight until instructed to tighten according to the torque chart. Use standard methods and practices when attaching snowplow, including proper personal protective safety equipment.

Recommended Fastener Torque Chart					
Inch Fasteners Grade 5 and Grade 8					
Size	Torque (ft-lb)		Size	Torque (ft-lb)	
	 Grade 5	 Grade 8		 Grade 5	 Grade 8
1/4-20	8.4	11.9	9/16-12	109	154
1/4-28	9.7	13.7	9/16-18	121	171
5/16-18	17.4	24.6	5/8-11	150	212
5/16-24	19.2	27.3	5/8-18	170	240
3/8-16	30.8	43.6	3/4-10	269	376
3/8-24	35.0	49.4	3/4-16	297	420
7/16-14	49.4	69.8	7/8-9	429	606
7/16-20	55.2	77.9	7/8-14	474	669
1/2-13	75.3	106.4	1-8	644	909
1/2-20	85.0	120.0	1-12	704	995
Metric Fasteners Class 8.8 and 10.9					
Size	Torque (ft-lb)		Size	Torque (ft-lb)	
	 Class 8.8	 Class 10.9		 Class 8.8	 Class 10.9
M6 x 1.00	7.7	11.1	M20 x 2.50	325	450
M8 x 1.25	19.5	26.9	M22 x 2.50	428	613
M10 x 1.50	38.5	53.3	M24 x 3.00	562	778
M12 x 1.75	67	93	M27 x 3.00	796	1139
M14 x 2.00	107	148	M30 x 3.50	1117	1545
M16 x 2.00	167	231	M33 x 3.50	1468	2101
M18 x 2.50	222	318	M36 x 4.00	1952	2701
These torque values apply to fasteners except those noted in the instructions.					

INSTALLATION INSTRUCTIONS

NOTE: For easier assembly and installation, vehicle and all snowplow components should be on a smooth, level, hard surface, such as concrete.

1. Remove the lower valance from the vehicle. Save valance and fasteners for reinstallation.



2. Starting on the driver's side, remove the compatibility bracket from the vehicle, if equipped. Retain the bracket and fasteners for reinstallation if the snowplow mount is removed.

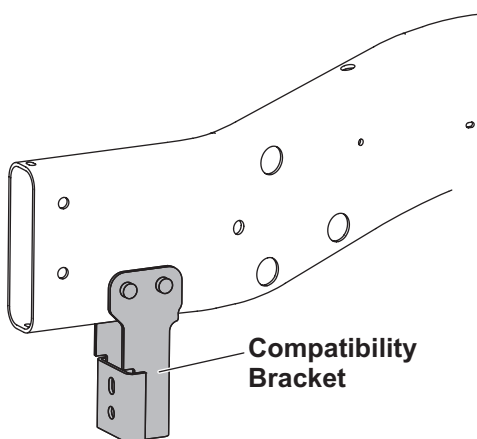

⚠ CAUTION

Before drilling any holes, check to be sure that no vehicle wiring or other components could be damaged.

3. Remove the upper and lower bumper bracket bolts, as well as the forward tow hook bolt. Save the tow hook bolt for reinstallation. Enlarge the upper and lower bumper bracket holes to 1/2".

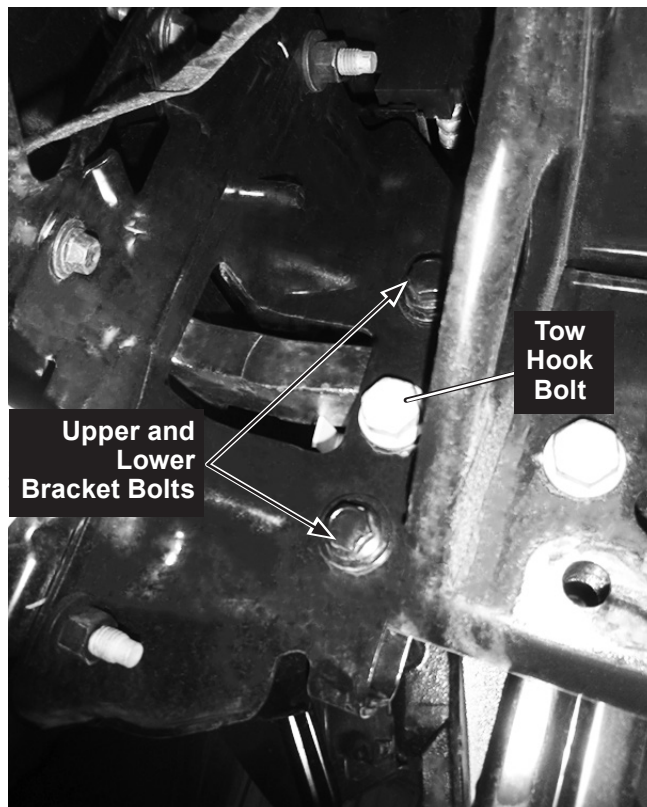

4. Slide the driver-side mount onto the vehicle frame.



5. Install a 1/2" x 4-1/2" cap screw through the mount and the lower bumper bracket hole. Secure the cap screw with a 1/2" locknut and hand tighten. Insert a 1/2" x 4" cap screw through the top bumper bracket hole. Secure with a 1/2" washer and a 1/2" locknut and hand tighten.

If vehicle is equipped with compatibility brackets, reinstall the tow hook bolt through the center clearance hole of the mount.

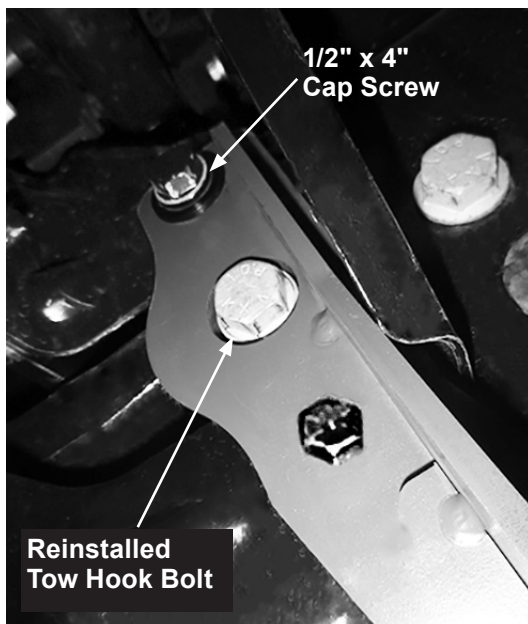

6. Reinstall one of the retained original bracket cap screws through the rear hole of the mount and the existing hole in the vehicle frame. Secure with the original nut.

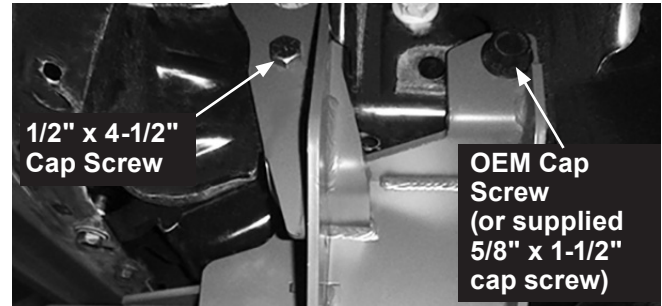

7. Repeat Steps 1–6 on the passenger's side of the vehicle. Then tighten all fasteners installed in the previous steps according to the torque chart. Be sure to level and straighten the bumper when tightening the bumper bracket bolts
8. Remove the driver-side and passenger-side stabilizer bar bracket bolts. Gently guide the stabilizer bar down to a resting position. Save stabilizer bar bracket bolts for reinstallation if the mount is removed.



If vehicle is not equipped with compatibility brackets, repeat Steps 1–5 on the passenger's side of the vehicle and retain the tow hook bolt for reinstallation (later in these instructions). Tighten all fasteners according to the torque chart. Skip to Step 8.

9. Install mount brackets over the stabilizer bar. Insert two M10 x 1.50 x 40 cap screws through the stabilizer bar bracket and mount bracket. Apply a small amount of lubricant to the M10 cap screws, then push the stabilizer bar and brackets up against the frame. Thread the M10 cap screws into the corresponding holes in the vehicle frame. Use caution to avoid damaging the threads.



10. Locate the upper hole in the stabilizer bracket on the passenger's side. Install a 5/8" x 1-1/2" cap screw through the bracket and the hole in the vehicle frame. Secure with the 5/8" locknut and hand tighten.



11. Install the thrust arms onto the tail of the mounts using two 1/2" x 1-1/2" cap screws on each mount. Secure with 1/2" locknuts and hand tighten.

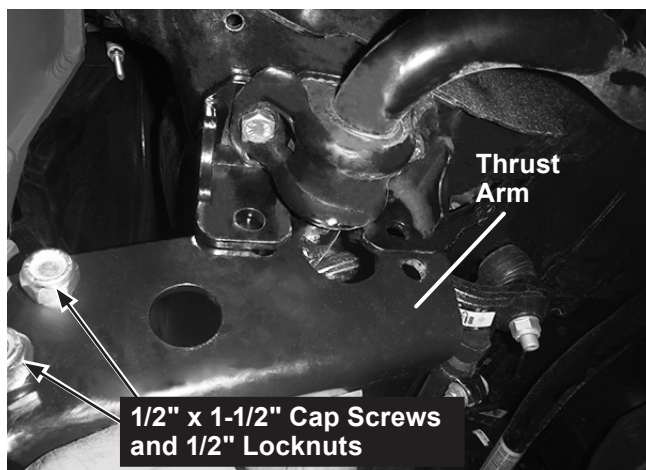

12. Fasten the thrust arm to the stabilizer bar bracket with two 1/2" x 1-1/2" cap screws and 1/2" locknuts.

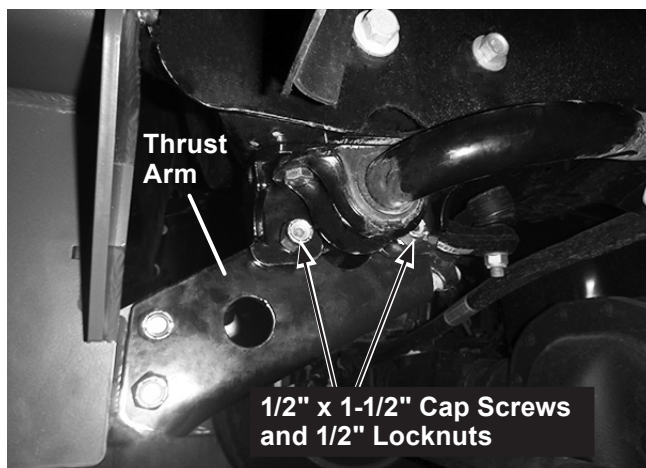

13. **For vehicles equipped with compatibility bracket, skip to Step 14. On vehicles without compatibility brackets:** Insert a 5/8" handled nut through the opening in the side of one frame rail and align with the holes in the frame. (If the handled nut does not fit through the opening in the frame, remove the tow hook completely, allowing insertion through the front of the frame. Cut and bend the handles as needed.)

Insert a 5/8" x 1-1/2" cap screw through both the mount hole and hole in the frame rail, and thread into the 5/8" handled nut. Repeat for the other frame rail. Trim any portion of the handles protruding through the frame openings.

14. Reinstall the tow hook (if previously removed) and all the retained tow hook fasteners.
15. Install the cross bar between the two mounts using four 1/2" x 1-1/2" cap screws and 1/2" locknuts.

16. Tighten all fasteners used in Steps 8–15 according to the torque chart. Start at the front of the mount and work rearward.
17. Trim the valance approximately as shown. Reinstall the valance using the retained fasteners.



NOTE: After five to ten hours of snowplow usage, retorque all mount assembly fasteners.

The company reserves the right under its product improvement policy to change construction or design details and furnish equipment when so altered without reference to illustrations or specifications used. This equipment manufacturer or the vehicle manufacturer may require or recommend optional equipment for snow removal. Do not exceed vehicle ratings with a snowplow. The company offers a limited warranty for all snowplows and accessories. See separately printed page for this important information.