

# 32051

## HARNESS KIT

### 3-PORT ISOLATION MODULE

### LIGHT SYSTEM

#### Parts List and Installation Instructions

**▲ CAUTION**

Read this document before installing the snowplow.

**▲ CAUTION**

See your sales outlet/website for specific vehicle application recommendations before installation. The online selection system has specific vehicle and snowplow requirements.

## PARTS LIST

Plow Light System			
Part	Description	Qty	
		32051	90730
73970	Vehicle Lighting Harness – 11-Pin	1	
31589	Plug-In Harness – 5 Relays	1	
31587	Vehicle Control Harness w/Switch Connector	1	
–	Snowplow Lighting Switch Assembly		
80175	Label – Notice, FMVSS Compliance	1	
29071	8" Cable Assembly		1
95837	Fuse Holder		1
90729	200A Fuse		1
–	Reclosable Fasteners	6	
–	Splices	1	
–	Heatshrink Tubing	1	

Snowplow Lighting Switch Assembly		
Part	Description	Qty
31583	Switch, Front Lighting	1
31585	Harness, Switch	1
32613	Switch Clip Kit	1
31617	Switch Cover Kit	1

LED Plow Light Kit		
Part	Description	Qty
72565	Headlamp Control Module (HCM)	1
72643	Adapter, Dual-Wire, HCM – 10-Pin	1
72546	Vehicle Harness Assembly – HCM to Grille	1
72548	Harness Assembly – Plow Lighting	1
72550	Cable Assembly – HCM	1
72552	Wire Assembly – EdgeView™ Lights	1
–	Reclosable Fasteners	4

## SAFETY DEFINITIONS

### WARNING

Indicates a potentially hazardous situation that, if not avoided, could result in death or serious personal injury.

### CAUTION

Indicates a potentially hazardous situation that, if not avoided, may result in minor or moderate injury. It may also be used to alert against unsafe practices.

**NOTE:** Indicates a situation or action that can lead to damage to your snowplow and vehicle or other property. Other useful information can also be described.

## FUSES

The snowplow electrical and hydraulic systems contain several blade-style automotive fuses. If a problem should occur and fuse replacement is necessary, the replacement fuse must be of the same type and amperage rating as the original. Installing a fuse with a higher rating can damage the system and could start a fire. Fuse Replacement, including fuse ratings and locations, is located in the Maintenance section of the Owner's Manual.

## BATTERY SAFETY

### CAUTION









Batteries normally produce explosive gases, which can cause personal injury. Therefore, do not allow flames, sparks, or lit tobacco to come near the battery. When charging or working near a battery, always cover your face and protect your eyes, and also provide ventilation.

- Batteries contain sulfuric acid, which burns skin, eyes, and clothing.
- Disconnect the battery before removing or replacing any electrical components.

## TORQUE CHART

### CAUTION

Read instructions before assembling. Fasteners should be finger tight until instructed to tighten according to the torque chart. Use standard methods and practices when attaching snowplow, including proper personal protective safety equipment.

Recommended Fastener Torque Chart					
Inch Fasteners Grade 5 and Grade 8					
Size	Torque (ft-lb)		Size	Torque (ft-lb)	
	 Grade 5	 Grade 8		 Grade 5	 Grade 8
1/4-20	8.4	11.9	9/16-12	109	154
1/4-28	9.7	13.7	9/16-18	121	171
5/16-18	17.4	24.6	5/8-11	150	212
5/16-24	19.2	27.3	5/8-18	170	240
3/8-16	30.8	43.6	3/4-10	269	376
3/8-24	35.0	49.4	3/4-16	297	420
7/16-14	49.4	69.8	7/8-9	429	606
7/16-20	55.2	77.9	7/8-14	474	669
1/2-13	75.3	106.4	1-8	644	909
1/2-20	85.0	120.0	1-12	704	995
Metric Fasteners Class 8.8 and 10.9					
Size	Torque (ft-lb)		Size	Torque (ft-lb)	
	 Class 8.8	 Class 10.9		 Class 8.8	 Class 10.9
M6 x 1.00	7.7	11.1	M20 x 2.50	325	450
M8 x 1.25	19.5	26.9	M22 x 2.50	428	613
M10 x 1.50	38.5	53.3	M24 x 3.00	562	778
M12 x 1.75	67	93	M27 x 3.00	796	1139
M14 x 2.00	107	148	M30 x 3.50	1117	1545
M16 x 2.00	167	231	M33 x 3.50	1468	2101
M18 x 2.50	222	318	M36 x 4.00	1952	2701
These torque values apply to fasteners except those noted in the instructions.					

TYPICAL 2-PLUG, 3-PORT MODULE SYSTEM DIAGRAM

NOTE: On 2-plug electrical systems, plug covers shall be used whenever snowplow is disconnected.

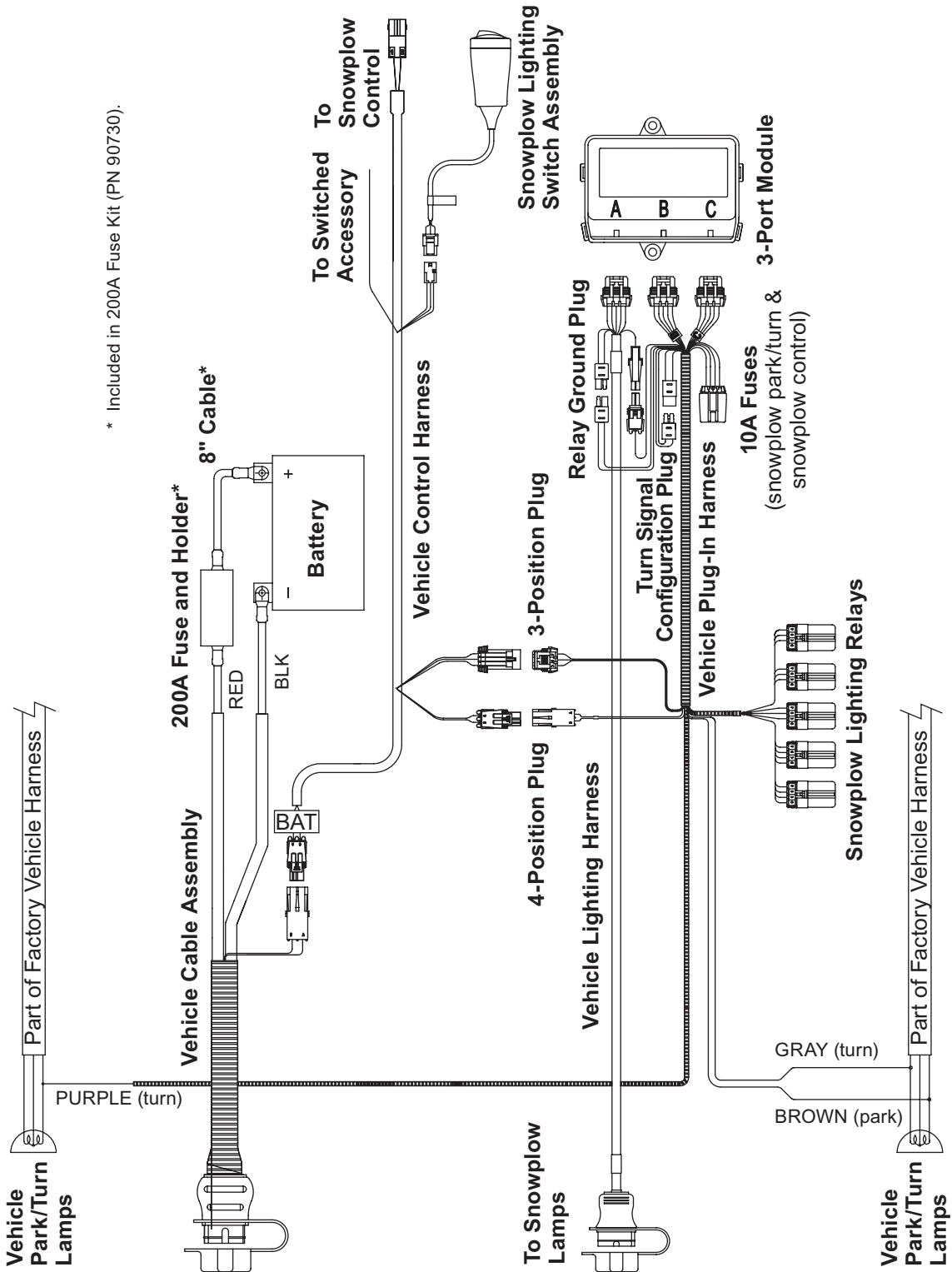

\* Included in 200A Fuse Kit (PN 90730).

## INSTALLATION INSTRUCTIONS

### Isolation Module Mounting

#### ⚠ CAUTION

Before installing self-drilling screws or drilling mounting holes, check the selected mounting area for any wires, hoses, or other obstructions.

1. Apply the FMVSS/CMVSS compliance label in a visible location inside of the vehicle cab. Inform the end user of its placement.

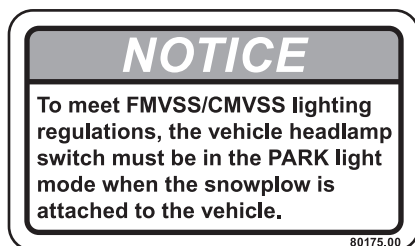

2. **Isolation modules are sold separately.** Check the online selection system for the correct module for your vehicle.

Locate a flat surface within the engine compartment of the vehicle for mounting the isolation module. If a suitable flat surface is not accessible, cable tie the isolation module to existing brackets or harnessing.

Reclosable fastener strips and/or cable ties are supplied for mounting the isolation module. When using reclosable fastener strips, the mounting surface must be free of dirt and grease.

**Isolation Module  
(bottom view)**

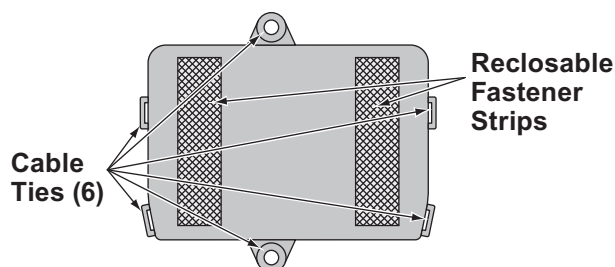

### Vehicle Battery Cable Installation

#### ⚠ CAUTION

Batteries normally produce explosive gases, which can cause personal injury. Therefore, do not allow flames, sparks, or lit tobacco to come near the battery. When charging or working near a battery, always cover your face and protect your eyes, and also provide ventilation.

- Batteries contain sulfuric acid, which burns skin, eyes, and clothing.
- Disconnect the battery before removing or replacing any electrical components.

**NOTE:** Follow OEM battery cable connection recommendations when attaching to the battery.

**NOTE:** Use dielectric grease on all electrical connections to prevent corrosion. Fill receptacles and lightly coat ring terminals before assembly.

1. Turn OFF the vehicle ignition.
2. Disconnect both the NEGATIVE (-) and the POSITIVE (+) battery cables from the vehicle battery.
3. Route the supplied vehicle battery cable from the grille or bumper to the battery, avoiding any sharp edges and hot or moving parts. Cable tie only the end section closest to the grille.

### 200A Fuse and Fuse Holder Installation

Install the 200A Fuse Kit (PN 90730) according to the Installation Instructions provided with the kit.

## Vehicle Lighting and Vehicle Control Harness Installation

For *Halogen plow light* installation, proceed with the following instructions.

For *LED plow light* installation, install the vehicle control harness as instructed, but **DO NOT** install the supplied vehicle lighting harness. Instead, refer to the LED Installation Instructions on page 10.

1. Route the supplied vehicle lighting harness from the grille or bumper to the isolation module mounting location, avoiding any sharp edges, hot surfaces, or moving parts. Cable tie only the end section closest to the grille at this time.
2. Connect the vehicle lighting harness to position "A" on the isolation module.

---

**NOTE: Install the vehicle control harness (PN 31587) supplied with this kit. The vehicle control harness (PN 28587) included in the snowplow hydraulic/electrical parts bag will not be used for this application, as it does not contain the necessary conductors to function correctly with this snowplow lighting system.**

---

3. Route the end of the vehicle control harness with the black 4-pin connector (labeled "BAT") to the black 4-pin connector located on the vehicle battery cable. Connect the two black 4-position connectors. Do not cable tie the harness at this time.
4. Route the remaining vehicle control harness to the isolation module mounting location.

### **⚠ CAUTION**

**Before installing self-drilling screws or drilling mounting holes, check the selected mounting area for any wires, hoses, or other obstructions.**

5. Locate an existing hole through the fire wall for the vehicle control harness. If access through the fire wall does not exist, drill a 5/8" hole through the fire wall in a convenient location away from sharp edges and hot or moving parts.
6. Push the braided harness breakout with the 4-position cab control and 3-position switch connectors through the fire wall hole into the cab. Use a grommet, existing plug cover, or proper anti-chafing material to protect the harness where it passes through the fire wall. Route the harness to the selected control mounting location.

To mount the control, follow the instructions supplied with the control.

To mount the switch, see the Snowplow Lighting Switch Mounting section on page 7.

7. Locate an accessory wire controlled by the ignition switch. Acceptable accessory wires show +12V when the ignition switch is turned ON, and 0V when it is OFF.
8. Route the red "ACC" wire from the vehicle control harness to this location and trim away excess length.
9. Following the recommended splicing procedure given at the end of this document, splice the red "ACC" wire into the switched accessory wire using the supplied parallel splices and heatshrink tubing.

---

**NOTE: Cable tie the control harness and accessory tap away from the brake, clutch, gas, or parking brake pedals, and any sharp, hot, or moving parts.**

---

## Snowplow Lighting Switch Mounting

1. Locate a flat surface on the vehicle dash within easy reach of the vehicle operator.
2. Cut the supplied reclosable fastener strips as shown and attach them to the lighting switch cover or the switch clip (if using) as indicated. When using reclosable fastener strips, the mounting surface must be free of dirt and grease.

Alternatively, the switch clip may be attached to the dash using two #6 flathead screws (not supplied).

3. Secure the switch to the dash in the manner and location chosen, and connect the lighting switch cable 3-position connector to the mating 3-position connector located on the vehicle control harness.
4. Secure extra cable under the dash away from any moving parts.

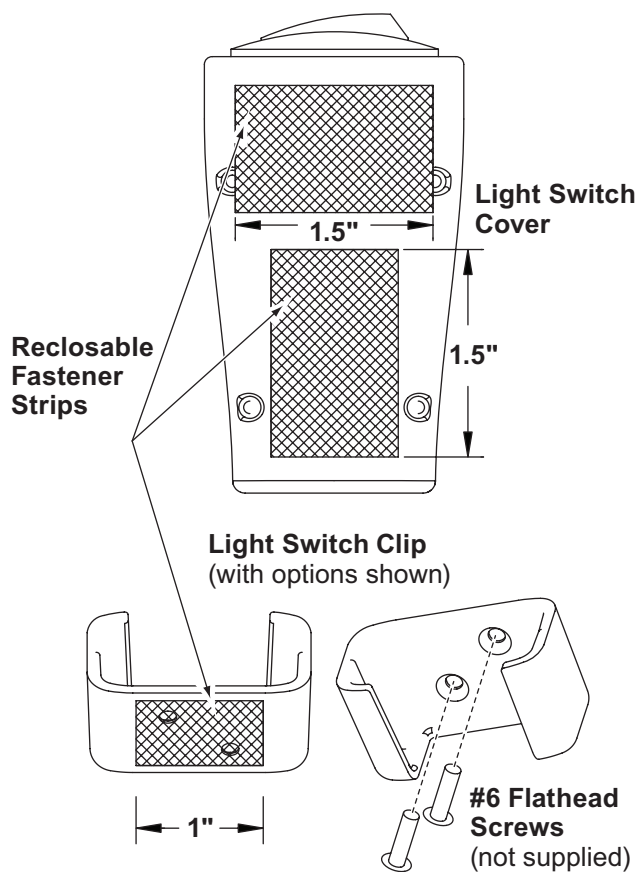

## PLUG COVER INSTALLATION

Stretch the rectangular opening of the plug cover strap over the end of the vehicle battery cable. Place the plug cover over the molded plug whenever the snowplow is not in use.

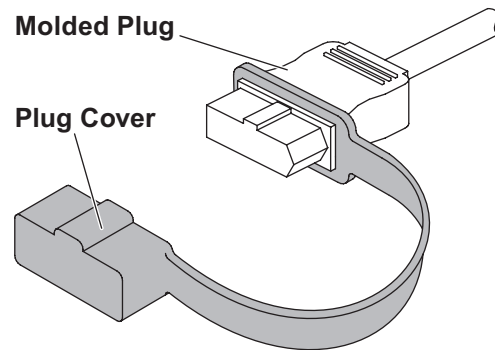

## PLUG-IN HARNESS INSTALLATION

1. Route the plug-in harness to the isolation module. Connect the plug-in harness to the module by matching harness connector B with module port B and harness connector C with module port C.
2. Connect the 4-position black connector on the vehicle lighting harness to the matching 4-position black connector on the plug-in harness.
3. Connect the 3-position connector on the vehicle lighting harness to the matching 3-position connector on the plug-in harness.
4. Connect the single-pin connector from the vehicle lighting harness to the single-pin connector from the plug-in harness.
5. Connect the 2-position male/female molded plug on the plug-in harness to the 2-position male/female molded plug on the vehicle lighting harness.

### **⚠ CAUTION**

**Before installing self-drilling screws or drilling mounting holes, check the selected mounting area for any wires, hoses, or other obstructions.**

6. Secure the relays using cable ties or the supplied connector clips on a flat vertical surface following the mounting pattern shown. Drill five 1/4" holes along the flat surface, pushing the connector clips into the drilled holes.

**Drill five 1/4" relay mounting holes, 1-5/8" apart.**

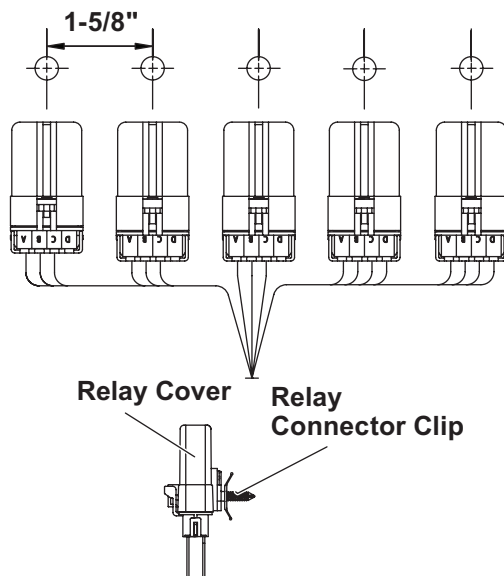

7. Locate the vehicle PARK wire on the side of the vehicle where the isolation module is located. Splice the brown wire from the plug-in harness into vehicle PARK wire following the recommended splicing procedure given at the end of this document.
8. Splice the gray wire from the plug-in harness into the TURN signal wire on the corresponding side.
9. Route the purple wire from the plug-in harness to the opposite side of the vehicle and splice into the vehicle TURN signal wire following the recommended splicing procedure.

**NOTE: If a suitable PARK wire or TURN signal source cannot be found on the vehicle front lighting assemblies, connections may be required to be made to the vehicle PARK or TURN signal source supplied to the rear of the vehicle. Consult with the vehicle manufacturer for a suitable signal source location.**

10. Cable tie the vehicle control harness, vehicle lighting harness, and plug-in harness away from any sharp, hot, or moving parts.

## Snowplow Lighting Relays

- **Right Power Relay w/15A Fuse**  
Wire colors: Red (4), Brown (1), Black/Orange (1)
- **Left Power Relay w/15A Fuse**  
Wire colors: Red (4), Brown (1), Black/Orange (1)
- **Daytime Running Lamp (DRL) Relay**  
Wire colors: Brown (1), Black/Orange (1), Red/Yellow (1), Pink (1)
- **Right Low-/High-Beam Relay**  
Wire colors: White (2), Red (1), Black (1), Black/Orange (1)
- **Left Low-/High-Beam Relay**  
Wire colors: White (1), White/Yellow (1), Red (1), Black/White (1), Black/Orange (1)

## TURN SIGNAL CONFIGURATION PLUG

### ⚠ WARNING

**If the turn signal configuration plug is mated incorrectly, the turn signals will be reversed between the vehicle and the snowplow.**

1. Mate the turn signal configuration plug located on the plug-in harness.

**If the isolation module is installed on the driver's side**, mate the plug so that the wire colors match (green to green and blue to blue).

**If the module is installed on the passenger's side**, mate the plug so that the wire colors are opposite (green to blue).

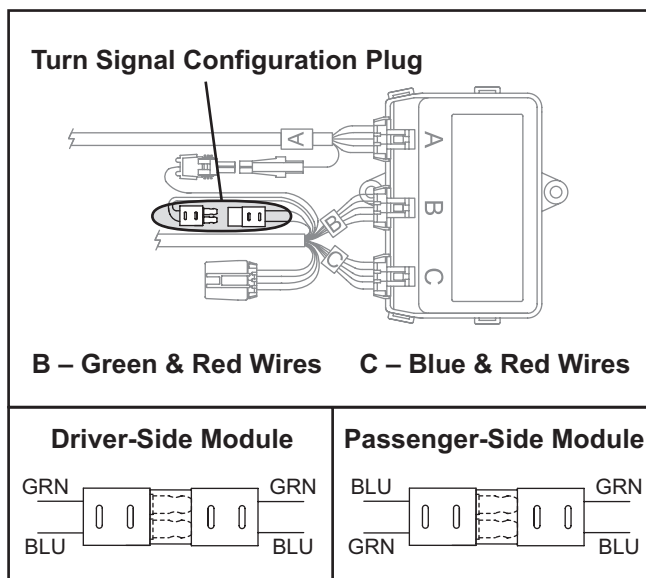

2. Complete the installation by securing the relay assemblies to an existing assembly with cable ties. Mount the relay connectors wire side down.

## LED INSTALLATION INSTRUCTIONS

### Headlamp Control Module (HCM) Mounting

Locate a flat surface within the engine compartment of the vehicle near the isolation module. If a suitable flat surface is not accessible, cable tie the HCM to existing brackets or harnessing.

Mount the HCM so that the harness connections are wire side down.

**NOTE: If possible, mount the HCM in an area that is protected from road splash.**

Reclosable fastener strips and/or cable ties are supplied for mounting the HCM. When using reclosable fastener strips, the mounting surface must be free of dirt and grease.

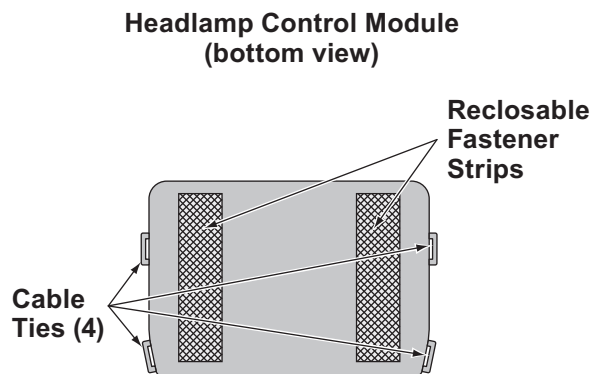

### HCM Vehicle Battery Cable Installation

#### **⚠ CAUTION**

Batteries normally produce explosive gases, which can cause personal injury. Therefore, do not allow flames, sparks, or lit tobacco to come near the battery. When charging or working near a battery, always cover your face and protect your eyes, and also provide ventilation.

- Batteries contain sulfuric acid, which burns skin, eyes, and clothing.
- Disconnect the battery before removing or replacing any electrical components.

**NOTE: Use dielectric grease on all electrical connections to prevent corrosion. Fill receptacles and lightly coat ring terminals before assembly.**

1. Turn OFF the vehicle ignition.
2. Disconnect both the NEGATIVE (-) and the POSITIVE (+) battery cables from the vehicle battery.
3. Route the supplied HCM vehicle battery cable from the battery to the 2-position mating connector on the HCM vehicle lighting harness, avoiding any sharp edges and hot or moving parts.

## HCM Vehicle Lighting Harness Installation

1. Route harnesses around or through the radiator bulkhead to the HCM.
2. Make the following connections:
  - 2-position connector from the vehicle lighting harness to the matching 2-position connector from the vehicle cable assembly
  - Vehicle lighting harness to position "Y" on the HCM
  - Single-pin connector from the plug-in harness assembly to the single-pin connector on the vehicle lighting harness
  - 2-position male/female relay enable plug from the plug-in harness to the matching 2-position plug from the HCM Vehicle lighting harness.
3. Route the red wire from the vehicle lighting harness to the stud on the HCM.
4. Remove the protective plastic domed nut and the top brass nut from the HCM stud. Install the red wire ring terminal on stud and remaining brass nut. Reinstall the top brass nut and tighten to 25.9 in-lb. Reinstall the protective plastic domed nut. (See illustration below.)

## PLUG COVER INSTALLATION

Stretch the rectangular opening of the plug cover strap over the end of the HCM vehicle lighting harness. Place the plug cover over the molded plug whenever the snowplow is not in use.

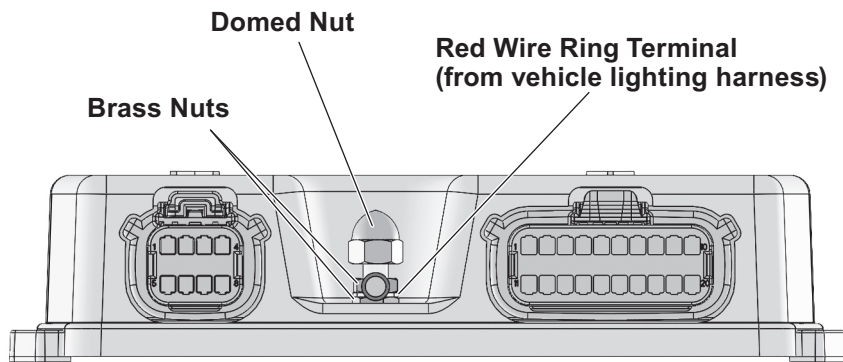
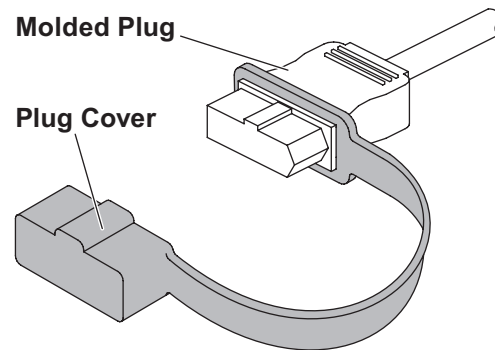

**Headlamp Control Module (HCM)**

**TYPICAL LED PLOW LIGHT, HEADLAMP CONTROL MODULE (HCM), AND HARNESS DIAGRAM**

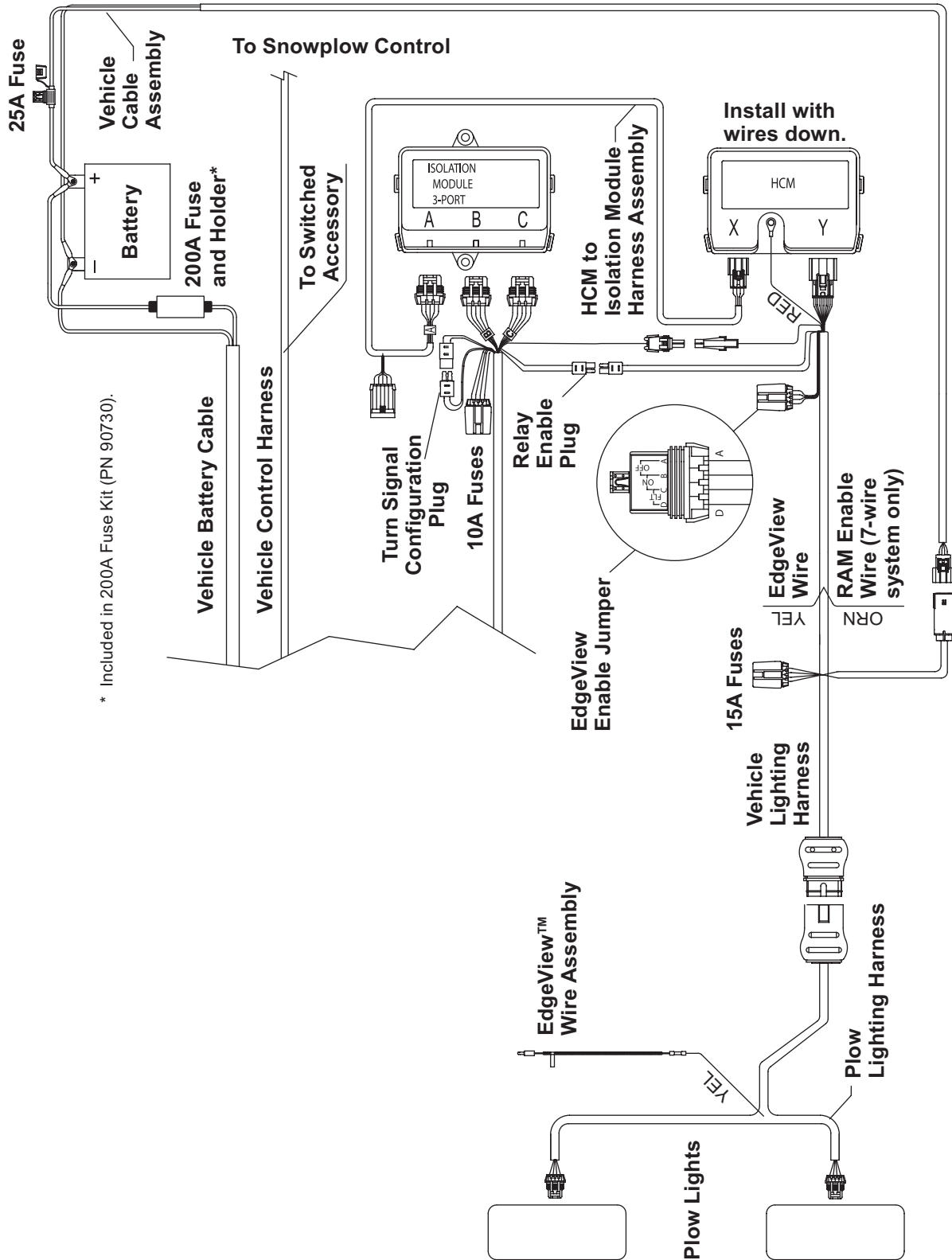

---

## HCM TO ISOLATION MODULE HARNESS INSTALLATION

1. Make the following connections:
  - 10-pin connector to port A of the isolation module
  - 8-position connector to port X of the HCM.
2. Cable tie harnesses as needed, away from any sharp, hot, or moving parts.

## BATTERY CONNECTIONS

---

**NOTE: Use cable ties to secure cable assemblies and control and lighting harnesses away from any sharp edges and hot or moving parts.**

---

**NOTE: Follow OEM battery cable connection recommendations when attaching to the battery.**

---

1. Make the following attachments to the POSITIVE (+) battery terminal:
  - POSITIVE (+) OEM cable assembly
  - Red 8" cable from fuse holder
  - Red cable from headlamp control module power cable.
2. Make the following attachments to the NEGATIVE (-) battery terminal:
  - NEGATIVE (-) OEM cable assembly
  - Black vehicle battery cable
  - Black cable from headlamp control module power cable.

## CHANGING BLADE-EDGE ILLUMINATION MODE

On snowplows equipped with LED headlamps, the EdgeView™ technology feature offers three modes for blade-edge illumination. The factory default setting is ON.

To change the blade-edge illumination mode, remove the cover from the fuse holder located near the "Y" port of the headlamp control module installed in the vehicle engine compartment.

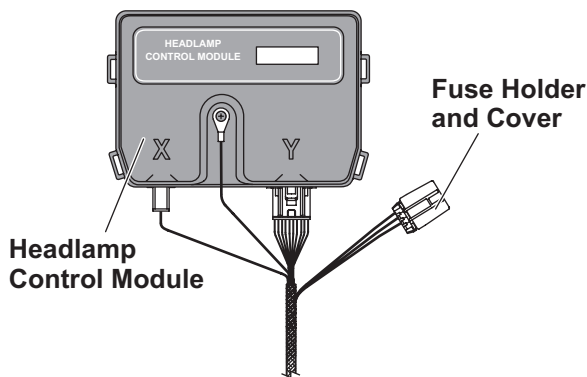

Remove the jumper fuse from the fuse holder and re-insert it in the desired mode position as shown below. Replace the fuse holder cover.

**Default – ON:**  
Blade edge lights illuminate when plow has power.

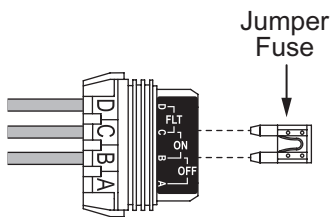

**FLT:** Blade edge lights illuminate when blade is in FLOAT mode.

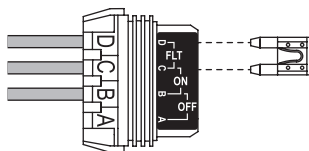

**OFF:** Blade edge lights disabled.

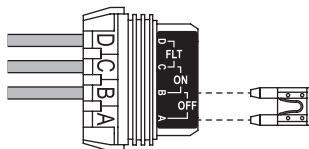

## PLOW-SIDE EdgeView LIGHTING CONNECTIONS

The EdgeView Float (FLT) mode activation function will require a second plow-side electrical connection.

1. On the plow-side LED lighting harness, locate the yellow wire cable tied to the body of the harness near the "Y" section.
2. Strip the end of the yellow wire and insert stripped wire end into the pre-installed insulated butt connector on the supplied EdgeView wire assembly.
3. Crimp the connection and heat seal the insulated splice.
4. Remove the snowplow hydraulic unit cover. Route the EdgeView wire assembly along the snowplow structure to the snowplow hydraulic unit, and cable tie wires as needed.
5. Locate the solenoid on the snowplow hydraulic unit that is activated during the snowplow Lower/Float function. Refer to the Mechanic's Guide or snowplow manufacturer's website for further information.
6. Plug the bullet terminal on the end of the supplied EdgeView wire assembly into the receptacle on the corresponding solenoid wire. If a receptacle is not found on the correct solenoid wire, remove the bullet terminal from the EdgeView wire assembly and splice the end of the EdgeView wire into the correct solenoid wire.
7. Cable tie extra wire length to the snowplow assembly and reinstall the hydraulic unit covers.

**NOTE: EdgeView light will turn ON or OFF approximately 5 seconds after EdgeView Mode is activated or canceled.**

## SNOWPLOW LIGHTING SWITCH OPERATION

The snowplow lighting switch has three indicators that will, when illuminated, indicate which snowplow lighting mode is active.

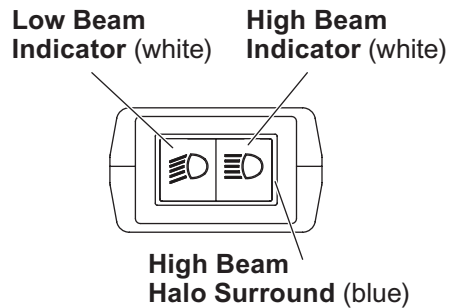

1. Before operating the snowplow lighting switch, verify that the snowplow is attached to the vehicle and all cable assemblies and lighting harnesses are connected. The vehicle headlamp switch should be in the OFF position.

2. Place the snowplow lighting switch into the low-beam position.
3. Place the vehicle headlamp switch into the PARK lighting position. The snowplow lighting switch low-beam indicator should be illuminated, and the snowplow PARK lights and low beams should be ON.
4. Place the snowplow lighting switch into the high-beam position. The snowplow lighting switch high-beam indicator and blue halo-surround should be illuminated and the snowplow high beams should be ON.

---

**NOTE:** To meet FMVSS/CMVSS lighting regulations, the vehicle headlamp switch must be in PARK light mode when the snowplow is attached to the vehicle.

---

## RECOMMENDED SPLICING PROCEDURE

1. Locate wire to be spliced into.
2. Cut wire at least 1-1/2" from any other splice, connector, or terminal. If wires are covered by tubing or braid, remove enough of it to achieve the minimum clearance required.
3. Strip away 5/16" of insulation from the ends of the wires to be spliced.
4. Slide two wires into one end of the supplied parallel splice.
5. Place a piece of heatshrink tubing (3/16" x 1-1/4" long) over the remaining wire to be spliced. Cut tubing into 1-1/4" lengths if required.
6. Insert the wire into the open end of the splice and crimp using an appropriate crimp tool. One or two crimps may be necessary to ensure a good connection. No wire strands should be visible outside of the splice.
7. Preheat a soldering tool for at least one minute to help promote even solder flow.
8. Apply heat to the splice. Avoid heating too close to the insulation. Apply solder to the wires. Use just enough solder to produce an even flow through the splice. **Use rosin core solder ONLY. Do not use acid core solder.**

**NOTE: Avoid using an excessive amount of solder, as it can result in wicking. Wicking occurs when solder travels up the wire core. This may cause the wire to become stiff or brittle, which could lead to a broken or open circuit.**

9. Check the circuits for continuity.
10. Cover the splice with heatshrink tubing. The tubing should extend beyond the splice on both sides.
11. Using a hot air source, starting in the center and working out to either side, apply heat until the tubing recovers and glue can be seen around the edges. Allow the tubing to cool before handling.

**NOTE: The splices supplied will accommodate 18-gauge wires as shown. For larger gauge wires, cut the wire, strip the ends 3/8" to 1/2", and twist together. Apply solder to the splice and cover with heatshrink tubing.**

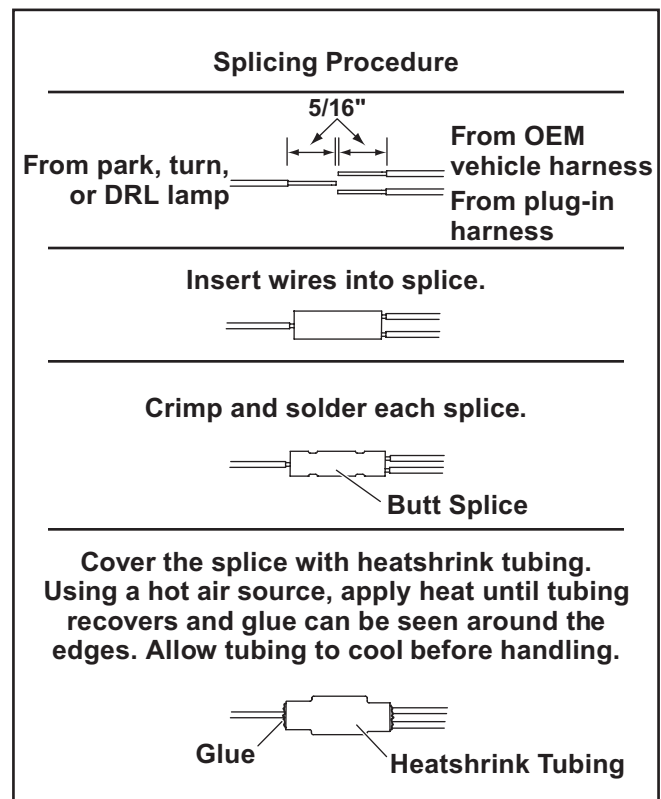

Copyright © 2023 Douglas Dynamics, LLC. All rights reserved. This material may not be reproduced or copied, in whole or in part, in any printed, mechanical, electronic, film, or other distribution and storage media, without the written consent of the company. Authorization to photocopy items for internal or personal use by the company's outlets or snowplow owner is granted.

The company reserves the right under its product improvement policy to change construction or design details and furnish equipment when so altered without reference to illustrations or specifications used. This equipment manufacturer or the vehicle manufacturer may require or recommend optional equipment for snow removal. Do not exceed vehicle ratings with a snowplow. The company offers a limited warranty for all snowplows and accessories. See separately printed page for this important information. The following is an unregistered (™) trademark of Douglas Dynamics, LLC: EdgeView™.

Printed in U.S.A.