

33925-2

MOUNT KIT COMPACT PLOW

RAM 1500

2019-__

Installation Instructions

▲ CAUTION

Read this document before installing the snowplow.

▲ CAUTION

See your sales outlet/website for specific vehicle application recommendations before installation. The online selection system has specific vehicle and snowplow requirements.

SAFETY DEFINITIONS

⚠ WARNING
 Indicates a potentially hazardous situation that, if not avoided, could result in death or serious personal injury.

⚠ CAUTION
 Indicates a potentially hazardous situation that, if not avoided, may result in minor or moderate injury. It may also be used to alert against unsafe practices.

NOTE: Indicates a situation or action that can lead to damage to your snowplow and vehicle or other property. Other useful information can also be described.

WARNING/CAUTION & INSTRUCTION LABELS

Become familiar with and inform users about the warning/caution and instruction labels on the back of the blade.

NOTE: If labels are missing or cannot be read, see your sales outlet.

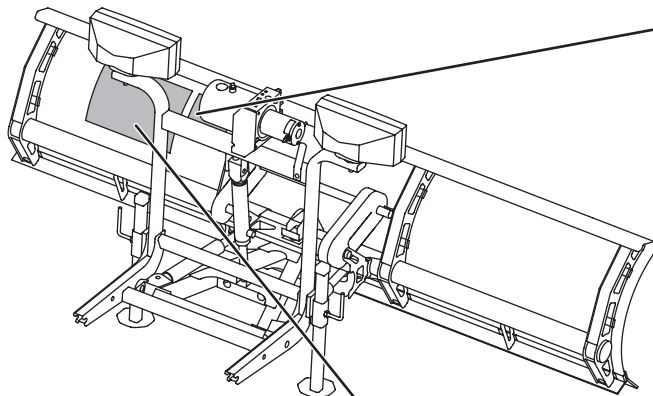

Instruction Label

Warning/Caution Label

⚠ WARNING	
	<p>Blade could drop unexpectedly, crushing or trapping limbs. Lower blade when vehicle is parked.</p> <p>Overloading could negatively affect vehicle handling. To avoid serious injury or death, do not exceed GVWR or GAWR including blade and ballast.</p>
⚠ CAUTION	
	<p>Read Owner's Manual before operating or servicing snowplow.</p> <p>Transport speed should not exceed 45 mph (72 km/h). Further reduce speed under adverse travel conditions.</p> <p>Plowing speed should not exceed 10 mph (16 km/h).</p> <p>See your sales outlet/website for specific vehicle application recommendations.</p> <p>www.</p>

SAFETY PRECAUTIONS

Improper installation and operation could cause personal injury and/or equipment and property damage. Read and understand labels and the Owner's Manual before installing, operating, or making adjustments.

⚠ WARNING

Lower the blade when vehicle is parked. Temperature changes could change hydraulic pressure, causing the blade to drop unexpectedly or damaging hydraulic components. Failure to do this could result in serious personal injury.

⚠ WARNING

The driver shall keep bystanders clear of the blade when it is being raised, lowered, or angled. Do not stand between vehicle and blade or within 8 feet of a moving blade. A moving or falling blade could cause personal injury.

⚠ WARNING

Keep hands and feet clear of the blade and A-frame when mounting or removing the snowplow. Moving or falling assemblies could cause personal injury.

⚠ WARNING

Do not exceed GVWR or GAWR including the blade and ballast. The rating label is found on the driver-side vehicle door cornerpost.

⚠ WARNING

To prevent accidental movement of the blade, always turn the control OFF whenever the snowplow is not in use. The power indicator light will turn OFF.

⚠ WARNING

Remove blade assembly before placing vehicle on hoist.

⚠ CAUTION

Refer to the online selection system for minimum vehicle recommendations and ballast requirements.

PERSONAL SAFETY

- Remove the ignition key and put the vehicle in PARK or in gear to prevent others from starting the vehicle during installation or service.
- Wear only snug-fitting clothing while working on your vehicle or snowplow.
- Do not wear jewelry or a necktie, and secure long hair.
- Wear safety goggles to protect your eyes from battery acid, gasoline, dirt, and dust.
- Avoid touching hot surfaces such as the engine, radiator, hoses, and exhaust pipes.
- Always have a fire extinguisher rated BC handy, for flammable liquids and electrical fires.

FIRE AND EXPLOSION

⚠ WARNING

Gasoline is highly flammable and gasoline vapor is explosive. Never smoke while working on vehicle. Keep all open flames away from gasoline tank and lines. Wipe up any spilled gasoline immediately.

Be careful when using gasoline. Do not use gasoline to clean parts. Store only in approved containers away from sources of heat or flame.

CELL PHONES

A driver's first responsibility is the safe operation of the vehicle. The most important thing you can do to prevent a crash is to avoid distractions and pay attention to the road. Wait until it is safe to operate mobile communication equipment such as cell phones, text messaging devices, pagers, or two-way radios.

VENTILATION

⚠ WARNING

Vehicle exhaust contains lethal fumes. Breathing these fumes, even in low concentrations, can cause death. Never operate a vehicle in an enclosed area without venting exhaust to the outside.

NOISE

Airborne noise emission during use is below 70 dB(A) for the snowplow operator.









VIBRATION

Operating snowplow vibration does not exceed 2.5 m/s² to the hand-arm or 0.5 m/s² to the whole body.

TORQUE CHART

⚠ CAUTION

Read instructions before assembling. Fasteners should be finger tight until instructed to tighten according to the torque chart. Use standard methods and practices when attaching snowplow, including proper personal protective safety equipment.

Recommended Fastener Torque Chart					
Inch Fasteners Grade 5 and Grade 8					
Size	Torque (ft-lb)		Size	Torque (ft-lb)	
	 Grade 5	 Grade 8		 Grade 5	 Grade 8
1/4-20	8.4	11.9	9/16-12	109	154
1/4-28	9.7	13.7	9/16-18	121	171
5/16-18	17.4	24.6	5/8-11	150	212
5/16-24	19.2	27.3	5/8-18	170	240
3/8-16	30.8	43.6	3/4-10	269	376
3/8-24	35.0	49.4	3/4-16	297	420
7/16-14	49.4	69.8	7/8-9	429	606
7/16-20	55.2	77.9	7/8-14	474	669
1/2-13	75.3	106.4	1-8	644	909
1/2-20	85.0	120.0	1-12	704	995
Metric Fasteners Class 8.8 and 10.9					
Size	Torque (ft-lb)		Size	Torque (ft-lb)	
	 Class 8.8	 Class 10.9		 Class 8.8	 Class 10.9
M6 x 1.00	7.7	11.1	M20 x 2.50	325	450
M8 x 1.25	19.5	26.9	M22 x 2.50	428	613
M10 x 1.50	38.5	53.3	M24 x 3.00	562	778
M12 x 1.75	67	93	M27 x 3.00	796	1139
M14 x 2.00	107	148	M30 x 3.50	1117	1545
M16 x 2.00	167	231	M33 x 3.50	1468	2101
M18 x 2.50	222	318	M36 x 4.00	1952	2701
These torque values apply to fasteners except those noted in the instructions.					

INSTALLATION INSTRUCTIONS

NOTE: For easier assembly and installation, vehicle and all snowplow components should be on a smooth, level, hard surface, such as concrete.

1. Remove the active air dam from underneath the vehicle, Retain for reinstallation if mount is removed.

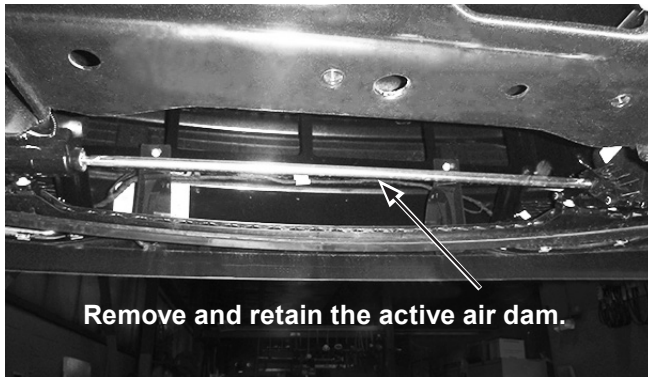

2. Remove the bumper from the vehicle and retain it for reinstallation.



3. Beginning on the passenger's side, remove and set aside the tow-hook bolt and small washer. Remove the large tow-hook washers, isolator, and tow hook and retain these parts for reinstallation if the mount is removed. Reinstall the small tow-hook washer and bolt. Torque fastener according to the torque chart.

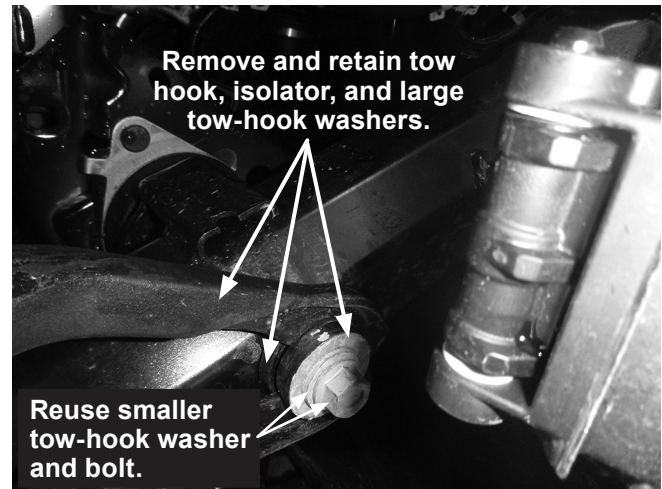

4. Repeat Step 3 on the driver's side.

NOTE: Bolt bag PN 74335 contains two types of cap screws for use in Step 5. Only one type will be needed for the installation. Determine which thread pitch (M14-1.5 x 40 or M14-2.0 x 45) will fit the vehicle and use that fastener to complete Step 5.

- Place the passenger-side hanger assembly against the outside of the passenger-side frame horn as shown. Install an M14 cap screw up through the front hole of the hanger assembly. The fastener should be snug, but not torqued.



⚠ CAUTION
 Before drilling any holes, check to be sure that no vehicle wiring or other components could be damaged.

- Using the upper holes of the passenger-side hanger assembly as a guide, drill two 17/32" holes through the frame horn.



- Place a 1/2" flat washer on a 1/2" x 1-1/2" cap screw with handle. Install it into the frame horn and out through the upper rear hole of the passenger-side hanger assembly. Secure the cap screw with a 1/2" locknut. Hand tighten.
- Place a 1/2" washer on a 1/2" x 1-1/4" cap screw. Install the cap screw through the upper front hole of the passenger-side hanger assembly.
- Repeat Steps 5–8 on the driver's side of the vehicle, using the driver-side hanger assembly.
- Tighten all fasteners installed in the previous steps according to the torque chart.
- Remove the splash shield that is attached to the vehicle cross member, if so equipped. Save the splash shield and fasteners for reinstallation.
- Place a 1/2" flat washer on each of two 1/2" x 1-1/2" cap screws with handles. Install the cap screw with handle down through the non-threaded holes in the bottom of the cross member as shown below.



13. Slide the rear thrust assembly into place. The cap screw with handle installed in Step 12 should protrude through the bottom holes of the assembly. Install a 1/2" x 1-1/4" cap screw through the top hole of the assembly. Secure each cap screw with handle using a 1/2" locknut. Secure the 1/2" x 1-1/4" cap screw with a 1/2" washer and 1/2" locknut. Tighten the fasteners according to the torque chart. Fasten the splash shield (if equipped) to the rear thrust assembly using the original fasteners removed in Step 11. For 2025 and newer model years use supplied spacer and longer M10 fasteners to level the rear of the splash shield.

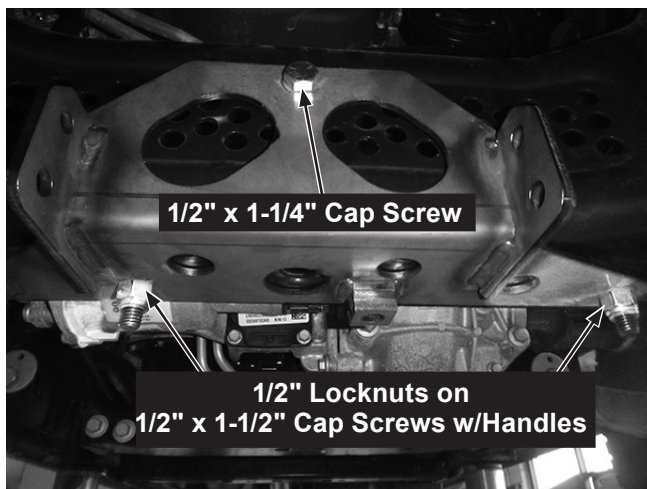

14. With the help of another person, reinstall the bumper. Trim the plastic air dam as necessary to install the mount beam between the passenger- and driver-side hanger assemblies. 2025 and newer model years might require more trimming to the metal portion of the bumper.

Insert 1/2" x 1-1/4" cap screws through the hanger assemblies and the mount beam (8 total). Secure each fastener with a 1/2" locknut. Hand tighten.

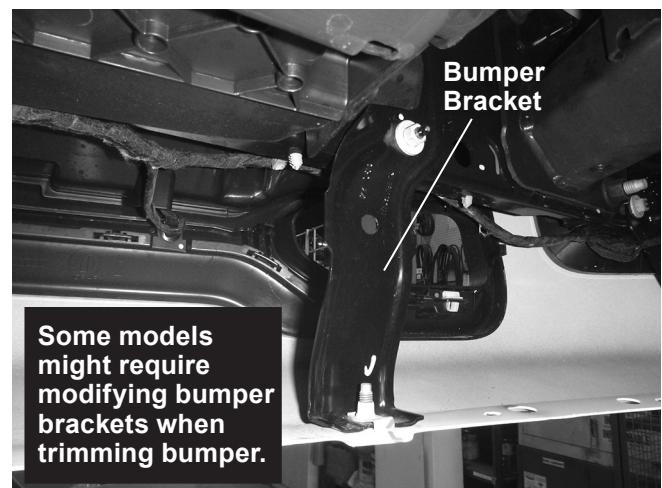

15. If the vehicle is equipped with a secondary radiator (Diesel models), loosen the fasteners of the brackets that hold the lower radiator. Push the radiator up as much as the brackets will allow, and then tighten the bracket fasteners. This will ensure that there is adequate space between the mount beam and radiator.

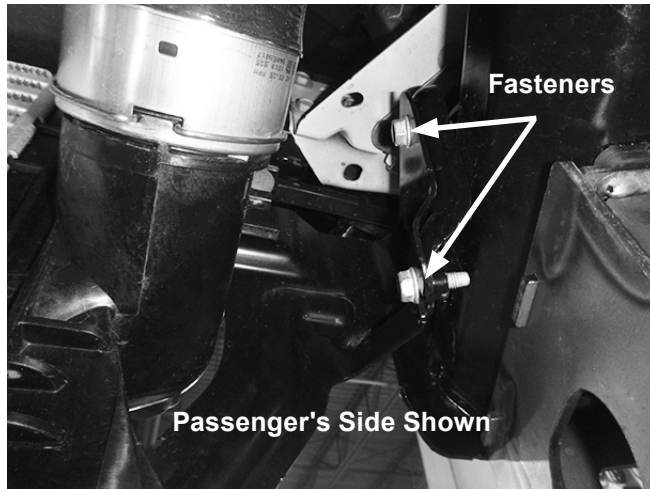

16. Install the thrust arms to the rear thrust assembly using 1/2" x 1-1/4" cap screws. Secure the thrust arms to the rear tabs of the mount beam in a similar fashion.



17. Tighten all fasteners according to the torque chart.

NOTE: After five to ten hours of snowplow usage, retorque all mount assembly fasteners.

The company reserves the right under its product improvement policy to change construction or design details and furnish equipment when so altered without reference to illustrations or specifications used. This equipment manufacturer or the vehicle manufacturer may require or recommend optional equipment for snow removal. Do not exceed vehicle ratings with a snowplow. The company offers a limited warranty for all snowplows and accessories. See separately printed page for this important information.

Printed in U.S.A.