

50 YEARS TOGETHER
DECOR-REST®

DUFRESNE CORE PRICE LIST

May 2024

511 Chrislea Road, Woodbridge (Toronto) Ontario Canada L4L 8N6 • Tel 905 856 5956 • Fax 905 856 2034 • www.decor-rest.com



 **Dufresne**

drsg  Proudly Canadian
Dufresne retail Solutions Group

STYLE: Alessandra Connections 2A **FEATURES**

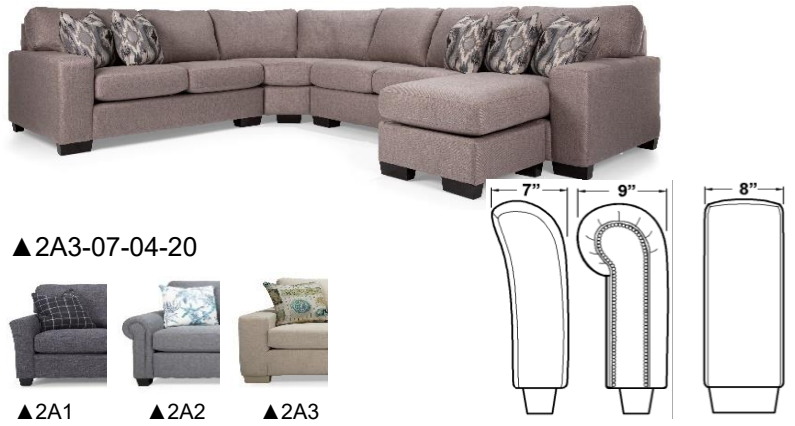

Spring: Sinuous Spring Construction
Seat Foam: 1.9 lb. Standard Foam, Option of Firm. 1.9 lb Soft foam seating in bed, Option of standard
Back & Seat Cushion: Semi-Attached back, box seat
Pillow: Please NOTE BELOW for quantity - 20" x 20", your fabric choice with self-welt
Pillow Insert: Feather Blend
Finishes: Fruitwood, Espresso, Black, Pewter, Antique Grey & Cream
Leg Type: 2A1 & 2: 3" Square, not attached, Ottoman: 5" Tapered Leg Only
 2A3: 3" Rectangle, not attached
Nail Studs: 2A2: Optional: Small Pewter, Antique Brass, Brass, Gold or Nickel finish nail studs with self-welt OR self-welt ONLY. Nail studs along arm facing
IMPORTANT NOTE: *Must add the arm width measurement to BA (between arms) measurement for total length
Special Features: Available in leather, style 3A
 Premium Memory Gel Foam Mattress at an upcharge. See Service Manual

▲ 2A1 ▲ 2A2 ▲ 2A3
 Arm style choice # 2A1 2A2 2A3

Available Fabric Code: A, UTRA

DESCRIPTION ▼ ARM # (MUST SPECIFY ARM STYLE)	PILLOW	CDN PRICING				DIMENSIONS (body only)								WEIGHT (LBS)	CUBES
		Floor	23-33	38-53	58-93	98 >	L	D	H	AH	SD	SH	BA		
2A ___ -00 - Storage Ottoman			330	360	400	480	32	24	19					25	11
2A ___ -01 - Sofa - 3 back over 3 seat	2		680	740	820	980	*	39	38	25	22	19	*71	100	67
2A ___ -02 - Loveseat	2		660	720	800	960	*	39	38	25	22	19	*48	75	51
2A ___ -03 - Chair			440	470	510	590	*	39	38	25	22	19	*24	50	33
2A ___ -04 - Wedge	1		560	620	700	860	48	48	38		22	19		75	46
2A ___ -05 - Corner	1		480	510	550	630	39	39	38		22	19		75	36
2A ___ -06 - RHF Loveseat	2		640	700	780	940	*	39	38	25	22	19	*48	75	43
2A ___ -07 - LHF Loveseat	2		640	700	780	940	*	39	38	25	22	19	*48	75	43
2A ___ -13 - Armless chair			420	450	490	570	24	39	38		22	19		50	17
2A ___ -16 - RHF Sofa	2		660	720	800	960	*	39	38	25	22	19	*71	100	60
2A ___ -17 - LHF Sofa	2		660	720	800	960	*	39	38	25	22	19	*71	100	60
2A ___ -20 - RHF Sofa with Chaise (with floating base)	2		860	920	1000	1160	*	63	38	25	22/47	19	*71	125	64
2A ___ -22 - LHF Sofa with Chaise (with floating base)	2		860	920	1000	1160	*	63	38	25	22/47	19	*71	125	64
2A ___ -25 - Ottoman with chaise seat cushion			260	290	330	410	24	53	20		47	19		25	7
2A ___ -30 - RHF Corner Sofa Sectional	2		680	740	820	980	93-95	39	38	25	22	19	69	100	70
2A ___ -31 - LHF Corner Sofa Sectional	2		680	740	820	980	93-95	39	38	25	22	19	69	100	70
2A ___ -38 - RHF Queen Bed	2		960	1020	1100	1260	*	39	38	25	22	19	*71	145	64
2A ___ -39 - LHF Queen Bed	2		960	1020	1100	1260	*	39	38	25	22	19	*71	145	64

NOTE: Fabrics above grade 43 are available.

All dimensions shown are approximate and are subject to the slight variations inherent in a hand built product. L: length D: depth H: height AH: arm height SD: seat depth SH: seat height BA: between arms. REFER TO FINISH PRODUCT MEASURING GUIDE PAGE

STYLE: Marco Connections 2M **FEATURES**



2M1-07-05-06

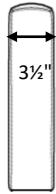

Available in leather style 3M

6.7" Wood Cone OR Metal Cone

- Spring:** Sinuous Spring Construction
- Seat Foam:** Premium High-Resiliency 2lb Super Soft Foam core;
Option of 1.9lb Standard as FIRM seat
- Back & Seat Cushion:** Loose back, box seat with top stitching
- Pillow:** Please NOTE BELOW for quantity B = 20" x 20" your fabric choice with self-welt
- Pillow Insert:** Feather Blend
- Wood Leg Finishes:** Fruitwood, Espresso, Black, Pewter, Antique Grey & Cream
- Metal Leg Finishes:** Pewter, Black & Brass
- Leg Type:** 7" Wood Cone or 6.7" Metal Cone Leg, not attached
- NOTE:** Sofa Only has a 5.5" Regular Center Support Wood Leg, not attached
- Special Features:** Reversible Seat Cushions - Waffle on one side and plain on the other
Not Reversible on the -08-RHF Chaise and -09 LHF Chaise

Available Fabric Code: A

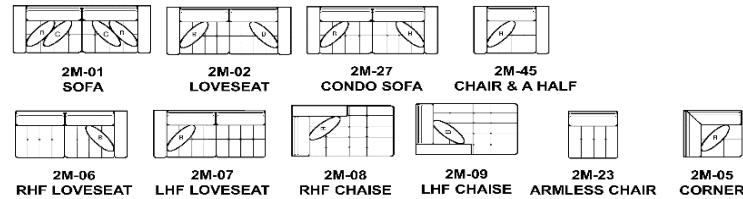

DESCRIPTION ▼ ARM # (MUST SPECIFY ARM STYLE)	PILLOW	CDN PRICING				DIMENSIONS							WEIGHT (LBS)	CUBES	
		Floor	23-33	38-53	58-93	98 >	L	D	H	AH	SD	SH			BA
2M-00 Ottoman			330	360	400	480	35	25	19		23	19		25	
2M1-01 Sofa - 2 back over 2 seat	4		680	740	820	980	86	38	37	29	23	19	79	100	57
2M1-02 Loveseat - 2 back over 2 seat	2		660	720	800	960	54	38	37	29	23	19	47	75	36
2M1-05 Corner	1		480	510	550	630	38	38	37		23	19		50	24
2M1-06 RHF Loveseat	1		640	700	780	940	67	38	37	29	23	19	63	75	43
2M1-07 LHF Loveseat	1		640	700	780	940	67	38	37	29	23	19	63	75	43
2M1-08 RHF Chaise (with floating ottoman)	1		680	740	820	980	36	62	37	29	46	19	32	70	39
2M1-09 LHF Chaise (with floating ottoman)	1		680	740	820	980	36	62	37	29	46	19	32	70	39
2M1-23 Armless Chair			470	500	540	620	32	38	37		23	19		50	20
2M1-27 Condo Sofa - 2 back over 2 seat	2		680	740	820	980	70	38	37	29	23	19	63	90	47
2M1-45 Chair and a Half	1		490	535	595	715	39	38	37	29	23	19	32	65	28

NOTE: Fabrics above grade 43 are available.

All dimensions shown are approximate and are subject to the slight variations inherent in a hand built product. L: length D: depth H: height AH: arm height SD: seat depth SH: seat height BA: between arms. REFER TO FINISH PRODUCT MEASURING GUIDE PAGE

STYLE: Marco Connections 3M **FEATURING 100% all LEATHER**



3M1-07-05-06



3M1-01 Sofa

Available in fabric style 2M

Spring: Sinuous Spring Construction
Seat Foam: Premium High-Resiliency 2lb Super Soft Foam core. Option of 1.9 lb. Standard Foam
Back & Seat Cushion: Loose back cushion with zipper.
 Non-Reversible waffle box seat with double stitching
Pillow: N/A
Wood Leg Finishes: Fruitwood, Espresso, Black, Pewter, Antique Grey & Cream
Metal Leg Finishes: Pewter, Black & Brass
Leg Type: 7" Wood Cone or 6.7" Metal Cone Leg, not attached
 NOTE: Sofa Only has a 5.5" Regular Center Support Wood Leg, not attached
Special Features: Available in fabric, style 2M



7" Wood Cone OR 6.7" Metal Cone

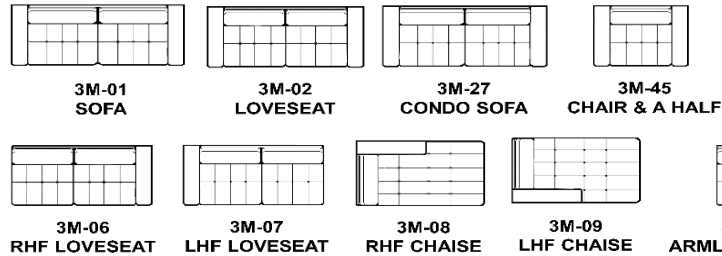

DESCRIPTION	PILLOW	CDN PRICING			DIMENSIONS							WEIGHT (LBS)	CUBES	
		100% all LEATHER	000 - 100	200	300	L	D	H	AH	SD	SH			BA
3M-00 Ottoman			480	530	580	35	25	19		23	19		25	
3M1-01 Sofa - 2 back over 2 seat			1300	1400	1500	86	38	37	29	23	19	79	100	57
3M1-02 Loveseat - 2 back over 2 seat			1250	1350	1450	54	38	37	29	23	19	47	75	36
3M1-05 Corner			820	870	920	38	38	37		23	19		50	24
3M1-06 RHF Loveseat			1180	1280	1380	67	38	37	29	23	19	63	75	43
3M1-07 LHF Loveseat			1180	1280	1380	67	38	37	29	23	19	63	75	43
3M1-08 RHF Chaise (with floating ottoman)			1200	1300	1400	36	62	37	29	46	19	32	70	39
3M1-09 LHF Chaise (with floating ottoman)			1200	1300	1400	36	62	37	29	46	19	32	70	39
3M1-23 Armless Chair			700	750	800	32	38	37		23	19		50	20
3M1-27 Condo Sofa - 2 back over 2 seat			1300	1400	1500	70	38	37	29	23	19	63	90	47
3M1-45 Chair and a Half			915	990	1065	39	38	37	29	23	19	32	65	28

NOTE: Fabrics above grade 43 are available.

All dimensions shown are approximate and are subject to the slight variations inherent in a hand built product. L: length D: depth H: height AH: arm height SD: seat depth SH: seat height BA: between arms. REFER TO FINISH PRODUCT MEASURING GUIDE PAGE

STYLE: 2404-Fabric & 3404-Leather Vernon **FEATURES**



Spring: Sinuous Spring Construction
Seat Foam: 1.9 lb. Standard Foam, Option of Firm.
 Default 1.9 lb soft foam seating in beds Option of Standard
Back & Seat Cushion: Tight back cushion, box seat with self-welt or contrast welt
Pillow: Please NOTE BELOW for quantity - 18" x 18" your fabric choice with self-welt
Pillow Insert: Recycled Leather, Fibre & Foam
Finish: Fruitwood, Espresso, Black, Pewter, Antique Grey & Cream
Leg Type: 3" Square, not attached
Special Features: Premium Memory Gel Foam Mattress at an upcharge. See Service Manual
 Available in fabric style 2404 and leather, style 3404
Available Fabric Code: A, UTR, UTR-A

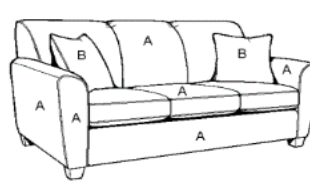

2404 - Fabric

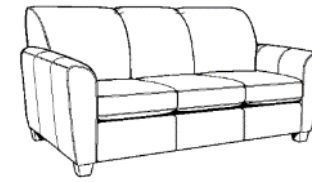

3404 - Leather

DESCRIPTION	PILLOW	CDN PRICING				DIMENSIONS							WEIGHT (LBS)	CUBES	
		Floor	23-33	38-53	58-93	98 >	L	D	H	AH	SD	SH			BA
2404 Sofa - 3 back over 3 seat)	2		570	630	710	870	84	35	36	25	23	19	69	100	56
2404 Condo Sofa - 3 back over 3 seat	2		570	630	710	870	77	35	36	25	23	19	62	90	51
2404 Loveseat	2		550	610	690	850	61	35	36	25	23	19	46	75	41
2404 Chair			430	460	500	580	38	35	36	25	23	19	23	50	25
2404 Double Bed - 3 back over 3 seat (89" depth when bed is open)	2		845	905	985	1145	77	35	36	25	23	19	62	125	51
2404 Queen Bed - 3 back over 3 seat (92" depth when bed is open)	2		870	930	1010	1170	84	35	36	25	23	19	69	150	56
2404 Ottoman			230	260	300	380	24	19	17					20	4
100% all LEATHER	PILLOW		000 - 100	200	300										
3404 Sofa - 3 back over 3 seat			1250	1350	1450		84	35	36	25	23	19	69	100	56
3404 Condo Sofa - 3 back over 3 seat			1250	1350	1450		77	35	36	25	23	19	62	90	51
3404 Loveseat			1200	1300	1400		61	35	36	25	23	19	46	75	41
3404 Chair			765	815	865		38	35	36	25	23	19	23	50	25
3404 Double Bed - 3 back over 3 seat (89" depth when bed is open)			1525	1625	1725		77	35	36	25	23	19	62	125	51
3404 Queen Bed - 3 back over 3 seat (92" depth when bed is open)			1550	1650	1750		84	35	36	25	23	19	69	150	56
3404 Ottoman			325	350	375		24	19	17					20	4

NOTE: Fabrics above grade 43 are available.

All dimensions shown are approximate and are subject to the slight variations inherent in a hand built product. L: length D: depth H: height AH: arm height SD: seat depth SH: seat height BA: between arms. REFER TO FINISH PRODUCT MEASURING GUIDE PAGE

STYLE: 2576 Astro Sectional **FEATURES**



Spring: Sinuous Spring Construction
Seat Foam: 1.9 lb. Standard Foam, Option of Firm.
Back & Seat Cushion: Semi attached back, box seat with self-welt
Pillow: Please NOTE BELOW for quantity. B, C=20" x 20" your fabric choice with self-welt
Pillow Insert: Recycled Leather, Fibre & Foam
Finish: Fruitwood, Espresso, Black, Pewter, Antique Grey & Cream
Leg Type: 3" Square, not attached
Special Features: Available as a Sofa, Loveseat, Chair and much more, style 2179
Available Fabric Code: A, C, S, P, UTR, UTRA

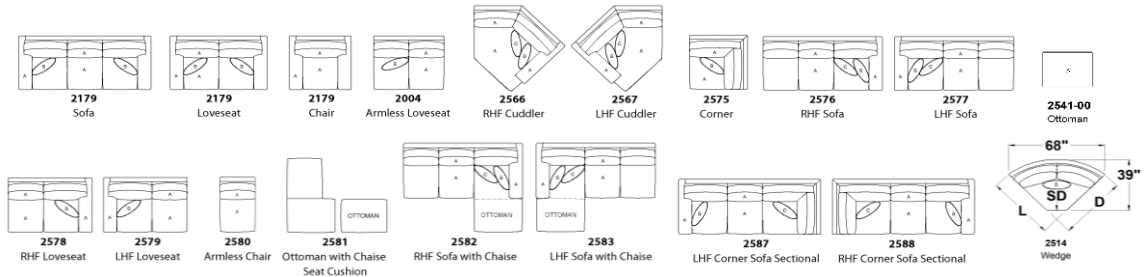

DESCRIPTION	PILLOW	CDN PRICING				DIMENSIONS						WEIGHT (LBS)	CUBES		
		Floor	23-33	38-53	58-93	98 >	L	D	H	AH	SD			SH	BA
2179 Sofa	2		680	740	820	980	84	40	38	27	21	19	66	100	68
2179-CS Condo Sofa (2 back over 2 seat)	2		680	740	820	980	76	40	38	27	21	19	60	100	62
2179 Loveseat	2		660	720	800	960	62	40	38	27	21	19	44	75	50
2179 Chair			440	470	510	590	40	40	38	27	21	19	22	50	32
2004 Armless Loveseat	1		550	610	690	850	45	40	37		21	19		50	35
2514 Wedge	1		560	620	700	860	68	39	37		23	19		75	57
2566 RHF Cuddler	2		680	740	820	980	61	62	37	27	34	19	28	100	74
2567 LHF Cuddler	2		680	740	820	980	61	62	37	27	34	19	28	100	74
2575 Corner	1		480	510	550	630	39	39	37		21	19		50	29
2576 RHF Sofa	2		660	720	800	960	75	40	37	27	21	19	66	100	59
2577 LHF Sofa	2		660	720	800	960	75	40	37	27	21	19	66	100	59
2578 RHF Loveseat	1		640	700	780	940	53	40	37	27	21	19	44	75	41
2579 LHF Loveseat	1		640	700	780	940	53	40	37	27	21	19	44	75	41
2580 Armless Chair			420	450	490	570	22	40	37		21	19		50	17
2581 Ottoman with chaise seat cushion			260	290	330	410	29	51	19						13
**2582 RHF Sofa with Chaise (with floating base)	2	770	860	920	1000	1160	75	62	37	27	44	19	66	125	59
2583 LHF Sofa with Chaise (with floating base)	2	770	860	920	1000	1160	75	62	37	27	44	19	66	125	59
**2587 LHF Corner Sofa Sectional	2	680	680	740	820	980	91	40	37	27	21	19	66	100	71
2588 RHF Corner Sofa Sectional	2	680	680	740	820	980	91	40	37	27	21	19	66	100	71
2541-00 Ottoman (recommended)			230	260	300	380	28	21	19.0					20	5

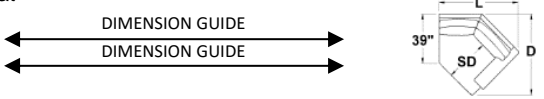

NOTE: Fabrics above grade 43 are available.

All dimensions shown are approximate and are subject to the slight variations inherent in a hand built product. L: length D: depth H: height AH: arm height SD: seat depth SH: seat height BA: between arms. REFER TO FINISH PRODUCT MEASURING GUIDE PAGE

STYLE: 2786 Sullivan Sectional **FEATURES**



- Spring:** Sinuous Spring Construction
- Seat Foam:** Default 1.9 LB. SOFT Foam Seating, Option of standard.
- Back & Seat Cushion:** **Stationary:** Semi-attached back, box seat with self-welt.
Power: Semi-attached back, tight box seat with self-welt.
- Pillow:** Please NOTE BELOW for quantity - 20" x 20", your fabric choice with self-welt
- Pillow Insert:** Feather Blend
- Leg Type:** 1.5 Triangle, not attached
- Special Features:** Available in all leather style 3786
 POWER available with 5V USB controller. Leggett and Platt Zero Wall Mechanism
 OPTION: Battery Backup at an upcharge. See Service Manual
- Finishes:** Fruitwood, Espresso, Black, Pewter, Antique Grey & Cream

Available Fabric Code: A

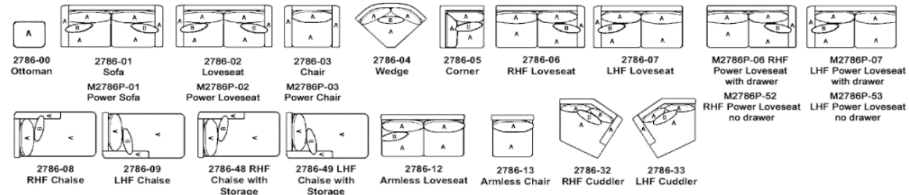

DESCRIPTION	PILLOW	CDN PRICING					DIMENSIONS							WEIGHT (LBS)	CUBES	
		Floor	23-33	38-53	58-93	98 >	L	D	H	AH	SD	SH	BA			
2786-00 Ottoman		230	230	260	300	380	23	23	17.5							5
2786-01 Sofa	2	680	680	740	820	980	85	39	35	24	23	18	69	100	64	
2786-02 Loveseat	2	660	660	720	800	960	62	39	35	24	23	18	46	75	47	
2786-03 Chair		440	440	470	510	590	39	39	35	24	23	18	23	50	29	
M2786P-01 Power Sofa	2	1330	1330	1390	1470	1630	85	39	35	24	23	18	69	100	64	
M2786P-02 Power Loveseat	2	1310	1310	1370	1450	1610	62	39	35	24	23	18	46	75	47	
M2786P-03 Power Chair		765	765	795	835	915	39	39	35	24	23	18	23	50	29	
2786-04 Wedge	1	560	560	620	700	860	49	49	35		26	18		75	47	
2786-05 Corner	1	480	480	510	550	630	39	39	35		23	18		75	29	
2786-06 RHF Loveseat	1	640	640	700	780	940	71	39	35	24	23	18	63	100	54	
2786-07 LHF Loveseat	1	640	640	700	780	940	71	39	35	24	23	18	63	100	54	
M2786P-06 RHF Power Loveseat - with drawer	1	1065	1065	1125	1205	1365	71	39	35	24	23	18	63	100	54	
M2786P-07 LHF Power Loveseat - with drawer	1	1065	1065	1125	1205	1365	71	39	35	24	23	18	63	100	54	
2786-08 RHF Chaise	1	680	680	740	820	980	40	65	35	24	49	18	32	70	50	
2786-09 LHF Chaise	1	680	680	740	820	980	40	65	35	24	49	18	32	70	50	
2786-12 Armless Loveseat	1	550	550	610	690	850	64	39	35	24	23	18		75	48	
2786-13 Armless Chair		420	420	450	490	570	32	39	35	24	23	18		50	24	
2786-14 RHF Chair	0	475	485	495	505	515	39	39	35	24	23	18	31	50	29	
2786-15 LHF Chair	0	475	485	495	505	515	39	39	35	24	23	18	31	50	29	
2786-32 RHF Cuddler	1	680	680	740	820	980	65	63	35	24	36	18	27	75	79	
2786-33 LHF Cuddler	1	680	680	740	820	980	65	63	35	24	36	18	27	75	79	
2786-48 RHF Chaise with Storage	1	850	850	910	990	1150	40	64	35	24	49	18	32	70	50	
2786-49 LHF Chaise with Storage	1	850	850	910	990	1150	40	64	35	24	49	18	32	70	50	
M2786P-52 RHF Power Loveseat - no drawer	1	965	965	1025	1105	1265	71	39	35	24	23	18	63	100	54	
M2786P-53 LHF Power Loveseat - no drawer	1	965	965	1025	1105	1265	71	39	35	24	23	18	63	100	54	

DECOR-REST

FURNITURE LTD

STYLE: 3786 Sullivan Sectional

FEATURING 100% all LEATHER



Spring: Sinuous Spring Construction

Seat Foam: Default 1.9 LB. SOFT Foam Seating, Option of standard.

Back & Seat Cushion: **Stationary:** Loose back cushion with zipper, box seat with self-welt.

Power: Loose back cushion with zipper, tight box seat with self-welt.

Pillow: NA

Leg Type: 1.5 Triangle, not attached

Special Features: Available in fabric, style 2786

POWER available with 5V USB controller. Leggett and Platt Zero Wall Mechanism

OPTION: Battery Backup at an upcharge. See Service Manual

Finishes: Fruitwood, Espresso, Black, Pewter, Antique Grey & Cream

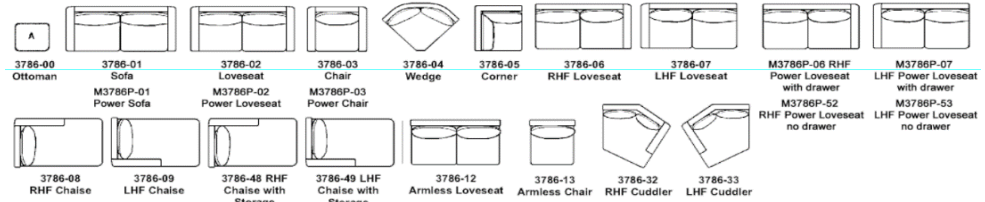

DESCRIPTION	100% all LEATHER	PILLOW	CDN PRICING			DIMENSIONS							WEIGHT (LBS)	CUBES
			000 - 100	200	300	L	D	H	AH	SD	SH	BA		
3786-00 Ottoman			355	380	405	23	23	17.5					25	5
3786-01 Sofa			1300	1400	1500	85	39	35	24	23	18	69	100	64
3786-02 Loveseat			1250	1350	1450	62	39	35	24	23	18	46	75	47
3786-03 Chair			820	870	920	39	39	35	24	23	18	23	50	29
M3786P-01 Power Sofa			1950	2050	2150	85	39	35	24	23	18	69	100	64
M3786P-02 Power Loveseat			1900	2000	2100	62	39	35	24	23	18	46	75	47
M3786P-03 Power Chair			1195	1295	1395	39	39	35	24	23	18	23	50	29
3786-04 Wedge			900	1000	1100	49	49	35		26	35	26	75	47
3786-05 Corner			820	870	920	39	39	35		23	18		75	29
3786-06 RHF Loveseat			1180	1280	1380	71	39	35	24	23	18	63	100	54
3786-07 LHF Loveseat			1180	1280	1380	71	39	35	24	23	18	63	100	54
M3786P-06 RHF Power Loveseat - with drawer			1605	1705	1805	71	39	35	24	23	18	63	100	54
M3786P-07 LHF Power Loveseat - with drawer			1605	1705	1805	71	39	35	24	23	18	63	100	54
3786-08 RHF Chaise			1200	1300	1400	40	65	35	24	49	18	32	70	50
3786-09 LHF Chaise			1200	1300	1400	40	65	35	24	49	18	32	70	50
3786-12 Armless Loveseat			1100	1200	1300	64	39	35	24	23	18		75	48
3786-13 Armless Chair			700	750	800	32	39	35	24	23	18		50	24
3786-14 RHF Chair			740	790	840	39	39	35	24	23	18	31	50	29
3786-15 LHF Chair			740	790	840	39	39	35	24	23	18	31	50	29
3786-32 RHF Cuddler			1200	1300	1400	65	63	35	24	36	18	27	75	79
3786-33 LHF Cuddler			1200	1300	1400	65	63	35	24	36	18	27	75	79
3786-48 RHF Chaise with Storage			1370	1470	1570	40	64	35	24	49	18	32	70	50
3786-49 LHF Chaise with Storage			1370	1470	1570	40	64	35	24	49	18	32	70	50
M3786P-52 RHF Power Loveseat - no drawer			1505	1605	1705	71	39	35	24	23	18	63	100	54
M3786P-53 LHF Power Loveseat - no drawer			1505	1605	1705	71	39	35	24	23	18	63	100	54

STYLE: 2963 FIONA

FEATURES

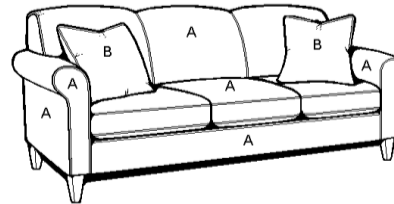

Leg Option: 5" Tapered OR 5" Turned

- Spring:** Sinuous Spring Construction
- Seat Foam:** 1.9 lb. Standard Foam, Option of Firm.
- Back & Seat Cushion:** Tight back, box seat with self-welt
- Pillow:** Please NOTE BELOW for quantity-20" x 20" your fabric choice with self-welt
- Pillow Insert:** Recycled Leather, Fibre & Foam
- Finishes:** Fruitwood, Espresso, Black, Pewter, Antique Grey & Cream
- Leg Type:** 5" Turned OR 5" Tapered, not attached
- Special Features:**
- Available Fabric Code:** A, C, S, P, UTR, UTRA

DESCRIPTION	PILLOW	CDN PRICING				DIMENSIONS							WEIGHT (LBS)	CUBES	
		Floor	23-33	38-53	58-93	98 >	L	D	H	AH	SD	SH			BA
2963 Sofa	2		550	610	690	850	78	36.5	36	26	22	19	66	100	51
2963 Loveseat	2		530	590	670	830	56	36.5	36	26	22	19	44	75	37
2963 Chair			420	450	490	570	34	36.5	36	26	22	19	22	50	22
2963 Ottoman			220	250	290	370	23	23	18.5					20	4

STYLE: LUCY **FEATURES**

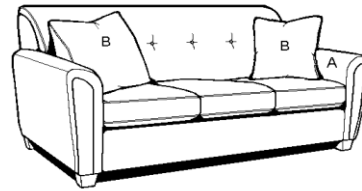

- Spring:** Sinuous Spring Construction
- Seat Foam:** 1.9 lb. Standard Foam, Option of Firm.
 Default 1.9 lb soft foam seating in beds. Option of Standard
- Back & Seat Cushion:** Tight back, box seat with self welt
- Pillow Please NOTE BELOW for quantity-18" x 18" your fabric choice with self-welt**
- Pillow Insert:** Recycled Leather, Fibre & Foam
- Finishes:** Fruitwood, Espresso, Black, Pewter, Antique Grey & Cream
- Leg Type:** 3" Square, not attached
- Special Features:** Premium Memory Gel Foam Mattress at an upcharge. See Service Manual
- Available Fabric Code:** A, UTRA

DESCRIPTION	PILLOW	CDN PRICING					DIMENSIONS							WEIGHT (LBS)	CUBES
		Floor	23-33	38-53	58-93	98 >	L	D	H	AH	SD	SH	BA		
LUCY Sofa	2	570	570	630	710	870	84	35	36	25	23	19	69	100	56
LUCY Condo Sofa	2	570	570	630	710	870	77	35	36	25	23	19	69	100	51
LUCY L Loveseat	2	550	550	610	690	850	61	35	36	25	23	19	46	75	41
LUCY Chair		430	430	460	500	580	38	35	36	25	23	19	23	50	25
LUCY Double Bed (3 back over 3 seat) (89" depth when bed is open)	2	845	845	905	985	1145	77	35	36	25	23	19	62	125	51
LUCY Queen Bed (3 back over 3 seat) (92" depth when bed is open)	2	870	870	930	1010	1170	84	35	36	25	23	19	69	150	56
LUCY Ottoman		230	230	260	300	380	24	19	17					20	6



PILLOWS



Pillows OR Kidney Pillows are included in a group at NO CHARGE up to Grade 78.

Pillows OR Kidney Pillows Grade 83 and over will have an EXTRA CHARGE of \$20 per pair.



ADDITIONAL PILLOWS & KIDNEY	PILLOW SIZE	DESCRIPTION	FILLING	PRICING PER GRADE			
				23-28 to 53	58 to 78	83 & over	
<p>MEASURING GUIDE</p> <p>*Slightly stretch out corners and measure end to end.</p>  	18" X 18"	Square - with NO Welt OR Square - with Welt	Recycled Leather, Fibre & Foam	\$30 each	\$40 each	\$50 each	
	20" X 20"						
	22" X 22"						
	24" X 24"						
	KIDNEY SIZE						
	21" x 13"	Rectangular - with NO Welt OR Rectangular - with Welt	Recycled Leather, Fibre & Foam	\$30 each	\$40 each	\$50 each	
	22" x 11"						
	23" x 16"						

FINISH PRODUCT MEASURING GUIDE

*See the sheet dimensions for the measurements that correspond with the letters below.
(Dimensions may vary ±1")

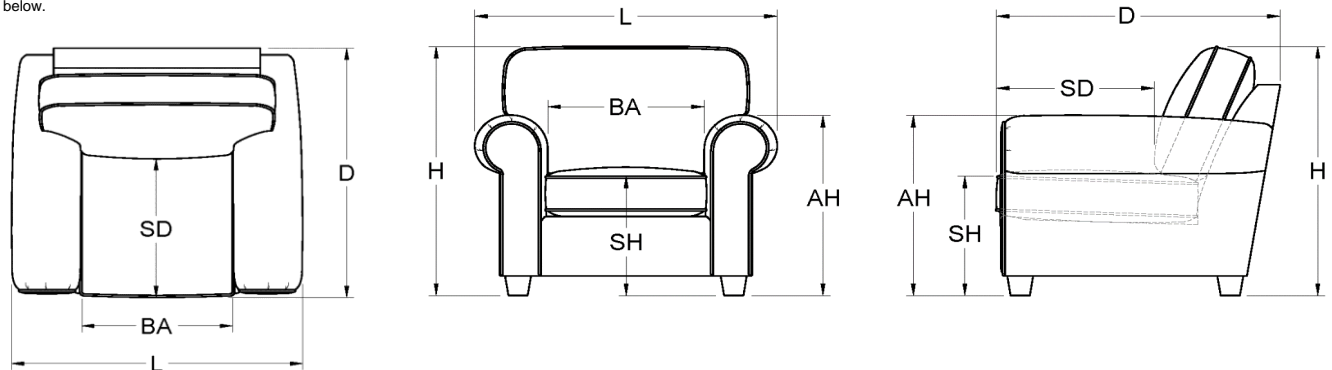

FABRIC COST

Grade 23- 28	\$20.00/m	\$18.25/yd
Grade 33	\$23.50/m	\$21.50/yd
Grade 38	\$27.00/m	\$24.75/yd
Grade 43	\$30.50/m	\$28.00/yd
Grade 48	\$34.00/m	\$31.25/yd
Grade 53	\$37.50/m	\$34.50/yd
Grade 58	\$41.00/m	\$37.75/yd
Grade 63	\$44.50/m	\$41.00/yd
Grade 68	\$48.00/m	\$44.25/yd
Grade 73	\$51.50/m	\$47.50/yd
Grade 78	\$55.00/m	\$50.75/yd
Grade 83	\$58.50/m	\$54.00/yd
Grade 88	\$62.00/m	\$57.25/yd
Grade 93	\$65.50/m	\$60.50/yd
Grade 98	\$69.00/m	\$63.75/yd
Grade 103	\$72.50/m	\$67.00/yd
Grade 108	\$76.00/m	\$70.25/yd
Grade 113	\$79.50/m	\$73.50/yd
Grade 118	\$83.00/m	\$76.75/yd
Grade 123	\$86.50/m	\$80.00/yd
Grade 128	\$90.00/m	\$83.25/yd
Grade 133	\$93.50/m	\$86.50/yd
Grade 138	\$97.00/m	\$89.75/yd
Grade 143	\$100.50/m	\$93.00/yd
Grade 148	\$104.00/m	\$96.25/yd
Grade 153	\$107.50/m	\$99.50/yd
Grade 158	\$111.00/m	\$102.75/yd
+increments	\$3.50/m	\$3.25/yd

UPHOLSTERY CLEANING CODES

W	Wet Cleaning. Water based cleaning agents or foam may be used for cleaning. Cleaning by a professional furniture cleaner is recommended.
S	Solvent cleaning. Only mild water-free dry-cleaning solvents may be used for cleaning this fabric.
W-S	Water based cleaning agents or foam may be used for cleaning. This fabric may also be cleaned with mild water-free solvents.
X	This fabric should be vacuumed or brushed lightly to remove soil. WARNING: Do not use foam or liquid cleaning agents of any type.

A FINAL REMINDER:

It is extremely important to PRE-TEST your cleaning method on hidden area of fabric to determine if colours bleed or if the fabric shrinks. When in doubt, seek the help of a professional furniture cleaner.
To obtain the most satisfaction for your furniture, give immediate attention to spots and establish a weekly routine for vacuuming all of your upholstery.

ABRASION INFORMATION

Delicate - 3000 to 6000 Double Rubs:	Primarily decorative. Care and respect
Light - 6000 to 9000 Double Rubs:	Adult household. Esthetic versus performance
Medium - 9000 to 12000 Double Rubs:	Normal use by adult
Heavy - 12,000 to 15,000 Double Rubs:	Normal use by active families with children.

AVAILABLE FABRIC CODES

A	ALL OVER
C	CENTER
S	STRIPE
P	PLAID
UTR	UP THE ROLL
UTRA	UP THE ROLL ALL OVER
RR	RAILROADED
XX	OCCASIONAL CHAIRS ONLY
XXX	PILLOWS ONLY

PER GRADE COSTING

FABRIC COSTING

\$4 Sofa/Queen Bed/Double Bed
\$4 Loveseat/Twin Bed
\$3 Chair and a Half
\$2 Chair / Ottoman

NOTE: Fabrics are graded in increments of five (5).
Increments costing from one level to the next is:

Sofa & Loveseat \$20
Chair and a Half \$15
Chair and Ottoman \$10

LEATHER COSTING

\$1 Sofa/Queen Bed/Double Bed
\$1 Loveseat/Twin Bed
.75¢ Chair and a Half
.50¢ Chair
.25¢ Ottoman

NOTE: Leather are graded in increments of one hundred (100).
Increments costing from one level to the next is:

Sofa & Loveseat \$100
Chair and a Half \$75
Chair \$50
Ottoman \$25

NOTE: Although a style may not show a specific grade, please use this guide to calculate price.

SERVICE MANUAL

SEAT CUSHION

	<u>Leather Complete</u>	<u>Fabric Complete</u>	<u>1.9 lb. Standard & Firm</u>	<u>Fabric Casing</u>	<u>Leather Casing</u>
Chaise	\$235	\$145	\$75	\$70	\$160
Single/Corner	\$150	\$90	\$50	\$40	\$100
Double	\$215	\$125	\$65	\$60	\$150
Sofa Bench	N/A	\$270	\$150	\$120	N/A
Loveseat Bench	N/A	\$180	\$100	\$120	\$200
Cuddler	\$265	\$145	\$65	\$80	\$200
Chair and a Half	\$215	\$125	\$75	\$60	\$150
Wedge	\$215	\$125	\$75	\$60	\$150

<u>Arms</u>	<u>Fabric</u>	<u>Leather</u>
Inside Arm	\$30	\$60
Outside Arm	\$20	\$35
Arm Facing	\$15	\$25
Complete	\$65	\$120

<u>Inside Back</u>	<u>Pulled Back</u>		<u>Semi Attached</u>		<u>Double Back & Loose Back</u>
	<u>Fabric</u>	<u>Leather</u>	<u>Fabric</u>	<u>Leather</u>	
Sofa	\$90	\$125	\$150	\$300	\$120
Loveseat	\$80	\$115	\$140	\$250	\$100
Chair	\$65	\$105	\$125	\$200	\$60

	<u>Fibre Filled Liner Casing</u>	<u>Recycled Liner Leather Casing</u>
Single Casing	\$40	\$80
Double Casing	\$50	\$100

<u>Outside Back</u>	<u>Fabric Complete</u>	<u>Leather Complete</u>
Sofa	\$75	\$160
Loveseat	\$70	\$120
Chair	\$65	\$90

<u>Deck & Edge</u> (cannot be sold separate)	<u>Fabric</u>	<u>Leather</u>	<u>Wings</u>	<u>Fabric</u>	<u>Leather</u>
				Outside Wing	\$15
Sofa	\$70	\$140	Inside Wing	\$20	\$40
Loveseat	\$55	\$110	Complete Wing	\$45	\$90
Chair	\$45	\$90			

<u>Front Band</u>	<u>Fabric</u>	<u>Leather</u>	<u>Edge</u> (only for sofas)	<u>Complete</u>
	Sofa	\$25	\$50	Sofa
Loveseat	\$20	\$40	Loveseat	\$20
Chair	\$15	\$30	Chair	\$15

<u>Motion Mechanisms</u>			
Single Power	\$275	Motion Power Cord	\$10
Single Sofa, Loveseat & Chair Rail	\$35	Battery Backup	\$120
Button Controller	\$25		

<u>Legs (each)</u>		<u>Bases</u>	<u>S</u>	<u>L</u>	<u>C</u>	<u>CHAISE</u>
Wood Leg	\$8	Wood Base (Standard)	\$150	\$135	\$125	\$135
Metal Leg	\$10					
		<u>Sinuous Springs</u>		<u>Sling Springs</u>		\$20
		Sofa	\$50			
		Loveseat	\$45			
		Chair	\$40			
		Single	\$10			

<u>SOFABED / SLEEPERS</u>	<u>Premium Memory Gel Foam Mattress</u>	<u>Standard Spring Mattress (5" thickness)</u>	<u>Mechanism Parts Only</u>
	Double Bed	\$250	\$125
Queen Bed	\$250	\$125	\$200
Commercial Double Bed	N/A	N/A	\$250
Commercial Queen Bed	N/A	N/A	\$250
Canvas	N/A	N/A	\$45
Transformer	\$250	N/A	\$400
	Add \$100 For Upcharge Only		Add \$50 for Commercial Upcharge ONLY

<u>Nail Studs</u>	each	<u>Dust Cover</u>	\$5/yd
Large studs (24 mm)	.50¢	Hollowfill Fibre 10 lb. bag	\$30 ea.
Small studs (11.5 mm)	.20¢	Enough for 1 Pillow	\$10
		Arm caps	\$25 pair
		Kidney pillows in leather	\$60 ea.
		Swivel Base	\$60 ea.
		Sectional Connectors	\$10 ea.
<u>Custom Fabric Application</u>	Upcharge		
2450 Chair (S, C, P, UTR)	\$92		
Remaining Chairs (upon approval)	20%		

PARTS LIST

1. Left hand facing skirt
2. Center skirt
3. Right hand facing skirt
5. Side skirt (Left or Right)
6. Right hand outside arm
7. Piping/Welt
8. Facing (Left or Right)
9. Right hand facing inside arm
10. Right hand facing inside back
11. Center inside back
12. Left hand facing inside back
13. Left hand facing inside arm
14. Piping/Welt
15. Right hand facing seat cushion
16. Center seat cushion
17. Left hand facing seat cushion
19. Front arm roush (Left or Right)
20. Edge
21. Flap
22. Bottom band
23. Cushion border
24. Inside back
25. Top band
26. Top band pull
27. Outside back
28. Back arm facing (Left or Right)
29. Outside back skirt
30. Left hand outside arm
31. Leg



NON-CONFORMANCE REPORT (This report to be submitted for all REPAIRS and PARTS)

DATE: _____ Ship to: _____

CUST.:# _____

Co. Name: _____ Attention: _____

DECOR-REST
INVOICE#: _____ **TAG:** _____ **PO #:** _____

STYLE#: _____ **SKU:** _____ **COVER:** _____

Pick one of the following:

a) PART REQUIRED (refer to Parts List):

_____ QTY: _____

OR

b) LOCAL REPAIR AMOUNT: \$ _____

(All back-up information, including local repair bills must be submitted within 30 days of the non-conformance date. Failure to do this will void your claim.)

OR

c) REPAIR & RETURN (description of item to be returned for repair):

Has the defective part been fabric or leather treated? _____

DESCRIPTION OF NON-CONFORMANCE:

DAMAGED GOODS TO BE RETURNED: YES _____ NO _____

Submitted by: _____

OFFICE USE ONLY: RMA # _____ DATE: _____ INITIAL: _____

Revision Date: Nov, 2004

511 Chrislea Road, Woodbridge (Toronto), Ontario L4L 8N6
 Tel: 905.856.5956 Fax: 905.856.2034 www.decor-rest.com

LIMITED WARRANTIES

Limited Warranties are non-transferable. The following Limited Warranties are given to the original retail purchaser of Decor-Rest Furniture Products.

LIFETIME means the normal useful life of the product.

Decor-Rest will pay, UPON APPROVAL, within one year from the date of purchase, reasonable and customary labor rates to repair or replace the defective parts and shipping costs from the retailer to and from Decor-Rest or a repair center designated by the Customer Service Department of Decor-Rest, at no charge to the original retail purchaser.

FRAMES – LIFETIME LIMITED WARRANTY

Decor-Rest warrants all frames to the original retail purchaser to be free from material and manufacturing defects. After one year the frame warranty covers replacement parts only.

SPRINGS – LIFETIME LIMITED WARRANTY

Decor-Rest warrants all springs construction to the original retail purchaser against spring breakage caused by metal fatigue or spring clips loosened from the frame. After one year the spring warranty covers replacement parts only.

ALL MECHANISMS – 3 YEAR WARRANTY

Decor-Rest warrants all mechanisms for three years from the date of purchase to be free from material or manufacturing defects. Year 2 & 3 mechanism warranty covers replacement parts only.

ELECTRONICS – 1 YEAR

All electronic parts are fully warranted for one year.

MATTRESS – 1 YEAR LIMITED WARRANTY

Decor-Rest warrants all mattresses for one year from the date of purchase, to be free from material or manufacturing defects. After one year from the date of purchase, the original retail purchaser will be responsible for replacement mattresses, packing, and all shipping and transportation costs.

FOAM

- 5 YEARS LIMITED WARRANTY ON FOAM CUSHIONS

All seat cushion cores will soften with normal use and will conform to the shape of the user. This shall be considered normal wear, and shall not be considered a loss of resiliency or a material-manufacturing defect. Fibre fill seat cushion tops, backs and arms will flatten with prolonged use. This is inherent to the design of fibre-filled and fibre-wrapped products. Regular fluffing will prevent internal fibres from matting and help to prolong the vibrancy of these products.

After one year from the date of purchase, based on the type of foam purchased, Decor-Rest will be responsible for replacement cushion cores only. The original retail purchaser will cover all costs associated to labor, packing, shipping and transportation.

LEATHER

- 2 YEARS LIMITED WARRANTY ON LEATHER

Decor-Rest warrants to the original retail purchaser, all leather to be free from defects in materials and workmanship, seam slippage, cracking, and dye transfers.

Leather is a natural product, and, as such, each hide will reflect its own individuality. Some variations of shade and tone are to be expected as are the nicks, scratches, and wrinkles that only occur in genuine leather; these characteristics are in no way to be considered a defect.

This warranty does not cover:

- heavy soiling or abuse
- improper or unapproved cleaning methods
- fading due to direct sunlight exposure
- leather that is exposed to a dry environment
- protective finishes

After one year from the date of purchase, based on the type of leather purchased, Decor-Rest will be responsible for replacement parts only. The original retail purchaser will cover all costs associated to labor, packing, shipping and transportation.

UPHOLSTERED FABRIC - 1 YEAR LIMITED WARRANTY

Decor-Rest warrants to the original retail purchaser, for a period of one year from the date of purchase, all upholstered fabrics against seam slippage, fraying, and dye transfers.

MAJESTIC FABRICS - 5 YEAR LIMITED WARRANTY

Decor-Rest warrants to the original retail purchaser, for a period of five year from the date of purchase, all upholstered fabrics against seam slippage, fraying, and dye transfers.

This warranty does not cover:

- tears, pilling, fading, or shrinking
- flattening of nap on velvets and velvet types since by their very nature, these fabrics are of soft texture and will crush, shade and mark more readily than most fabrics
- heavy soiling or abuse
- protective finishes

FINISHES (SHOW WOOD) AND ALL OTHER FURNITURE PRODUCTS - 1 YEAR LIMITED WARRANTY

All finishes and other parts, components, and other furniture products not specifically included in the above Limited Warranties, including headboards, are warranted by Decor-Rest to the original retail purchaser, for one year from the date of purchase to be free from material manufacturing defects.

LIMITATIONS AND EXCEPTIONS

Under these Limited Warranties, the sole liability of Decor-Rest is limited to repair, or at its option, replacement. Decor-Rest will pay, UPON APPROVAL, within one year from the date of purchase, reasonable and customary labor rates to repair or replace the defective parts and shipping costs from the retailer to and from Decor -Rest, at no charge to the original retail purchaser. After one year from the date of purchase, the original retail purchaser will be responsible for labor, packing, and all shipping and transportation costs.

ALL PRODUCTS

These Limited Warranties do not apply to:

- any merchandise purchased "as is" or second-hand,
- any merchandise purchased at a distress sale or a going-out-of business sale
- any merchandise purchased from a liquidator
- any condition resulting from misuse, abuse, delivery or transportation damage, nor any condition resulting from incorrect or inadequate maintenance, cleaning or care

CHEMICAL TREATMENTS

These Limited Warranties do not cover damages or defects caused by use of chemical treatments or protective coatings on the finish, leather, or upholstered fabric by the retailer or the original retail purchaser, and any such chemical treatments or protective coatings voids all warranties of Decor-Rest

LEATHER, UPHOLSTERED FABRIC AND FINISHES

The Limited Warranties on "Leather", "Upholstered Fabric" and "Finishes and all Other Furniture Products" do not cover:

- damages resulting from excessive soiling, improper or unapproved cleaning methods
- fading or other damages resulting from exposure to sunlight
- damages resulting from household humidity
- damages resulting from any liquid, including but not limited to alcohol and water.

CAUTION: Any use of improper or unapproved cleaning methods voids all warranties of Decor-Rest.

MODIFICATIONS TO PRODUCTS

These Limited Warranties do not apply to any products that have been altered by any person, dealer, or company without the express written authorization of Decor-Rest.

RESOLUTION

Part of our vision is to become the best supplier to our customer. We are looking forward to a long and prosperous relationship with you as our customer. We feel it would be beneficial to briefly advise you of our basic policies and procedures.

Under these Limited Warranties, Decor-Rest's exclusive obligation during the applicable warranty period is to repair or replace, at its option, any part or parts found, upon examination by an authorized manufacturer's representative of Decor-Rest to contain a material manufacturing defect.

If within the warranty period, identical materials are unavailable at the time of repair or replacement, Decor-Rest reserves the right to substitute materials of equal or better quality. Replacement fabrics and/or leathers may vary in color from the original due to dye lot differences.

Any item repaired or replaced under these Limited Warranties will be covered by the Limited Warranties for the remainder of the original warranty period only.

CLAIM PROCEDURE

If a problem should arise which you feel is covered by our Limited Warranties, contact the Decor-Rest authorized retailer from whom you purchased your furniture.

1. All complaints and claims need to be relayed to our customer service representative/sales agent within 30 days from the date the furniture is put into service from an authorized Decor-Rest retailer.
2. The original bill of sale is necessary for the fulfillment of the warranty. Upon approval, our customer service representative/sales agent will then issue an authorization number (RMA), after which, all back-up information, including local repair bills must be submitted within 30 days of the non-conformance date. Failure to do this will void your claim.
3. If merchandise is returned for repair the RMA number must appear on the outside of the package and/or delivery slip. Merchandise returned without RMA will not be accepted.
4. For all claims, Decor-Rest reserves the right to request photo verification and/or defective parts to be returned.
5. If there are claims on defective fabric/leather we will need a sample forwarded to us for evaluation. Evaluations typically require two weeks for lab work to determine the source of the problem.
6. If the defect is found to be a fabric/leather manufacturing problem, we stand behind our product and will make a fair and equitable settlement, based on depreciated value of the furniture
7. After one year from the date of purchase, the purchaser will be responsible for labor, packaging and all shipping and transportation cost.

We would like to thank you in advance for your assistance in following the above procedures.