

Panasonic	
?	
1.7k + 0.1k	
Panasonic	1.7k + 0.1k
SAMSUNG	1.7k + 0.1k
acer / SHARP	1.7k + 0.1k
TOSHIBA	1.7k + 0.1k
Lenovo / LG	1.7k + 0.1k
SONY	1.7k + 0.1k
EPSON	1.7k + 0.1k
FUJITSU	1.7k + 0.1k
NEC	1.7k + 0.1k
HP	1.7k + 0.1k
DELL	1.7k + 0.1k
Apple	1.7k + 0.1k

Jaren '70 & '80 woningen



Huishoudelijke mededelingen

- Presentatie en brochure te downloaden op de site
- Webinar geeft mogelijkheid tot terug kijken
- Vragen stellen op aangegeven momenten
- Niet aangemeld? Stuur email naar info@duurzaambouwloket.nl

Inhoudsopgave

1. Introductie
2. Jaren '70 & '80 woningen in de gemeente
3. Waarom verduurzamen?
4. Waar te beginnen en wat levert het op?
 - a. Isoleren
 - b. Ventileren
 - c. Elektriciteit
 - d. Verwarmen en koelen
5. Isolatie-actie
6. Subsidies en regelingen
7. Afsluiting

Duurzaam Bouwloket

- Gemeentelijk Energieloket
- Gratis en onafhankelijk advies
- Energiebesparende maatregelen
- Subsidies en financieringen
- Lokale acties en initiatieven
- Uitvoerende bedrijven

Brochure jaren '70 & '80 woningen



Hoeveel woningen in de gemeente

Er zijn 3.547 jaren '70 en '80 woningen (1970-1989*) in de gemeente Lisse

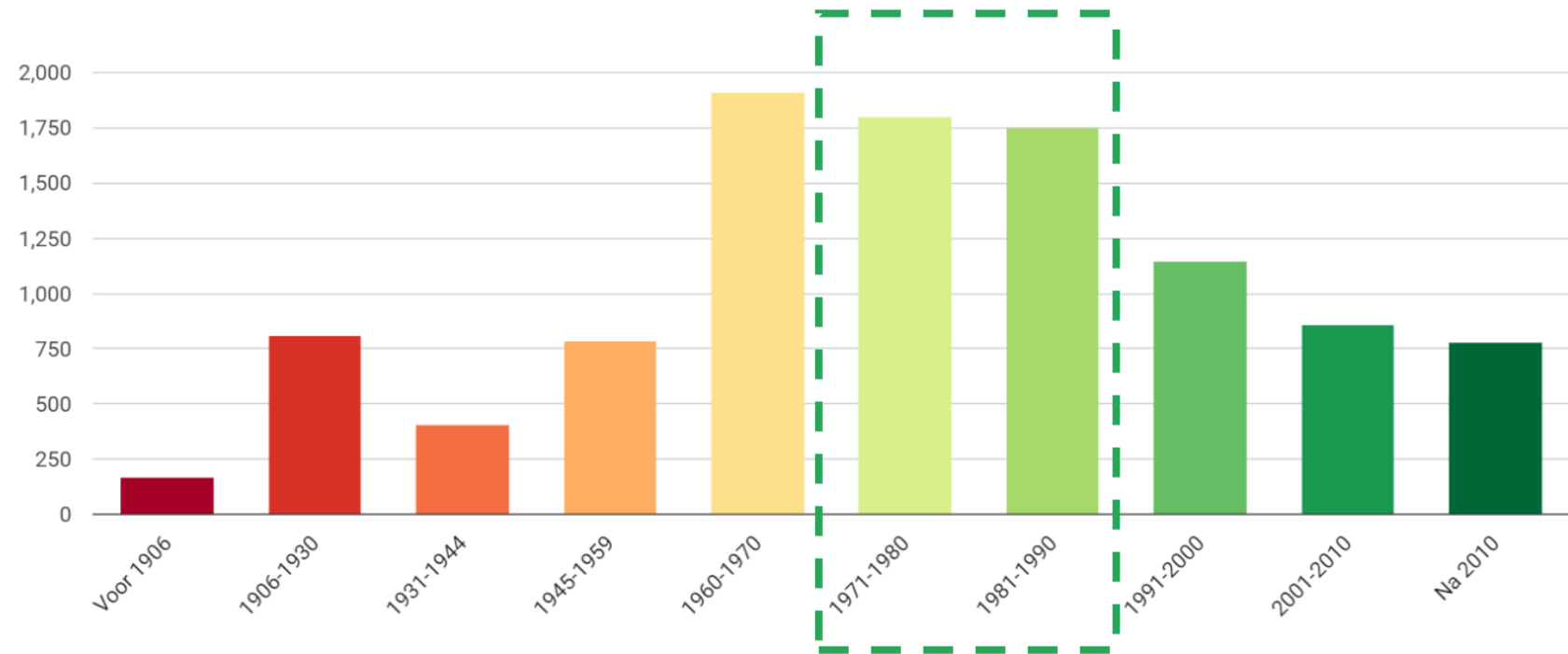

Bouwjaren en isolatie

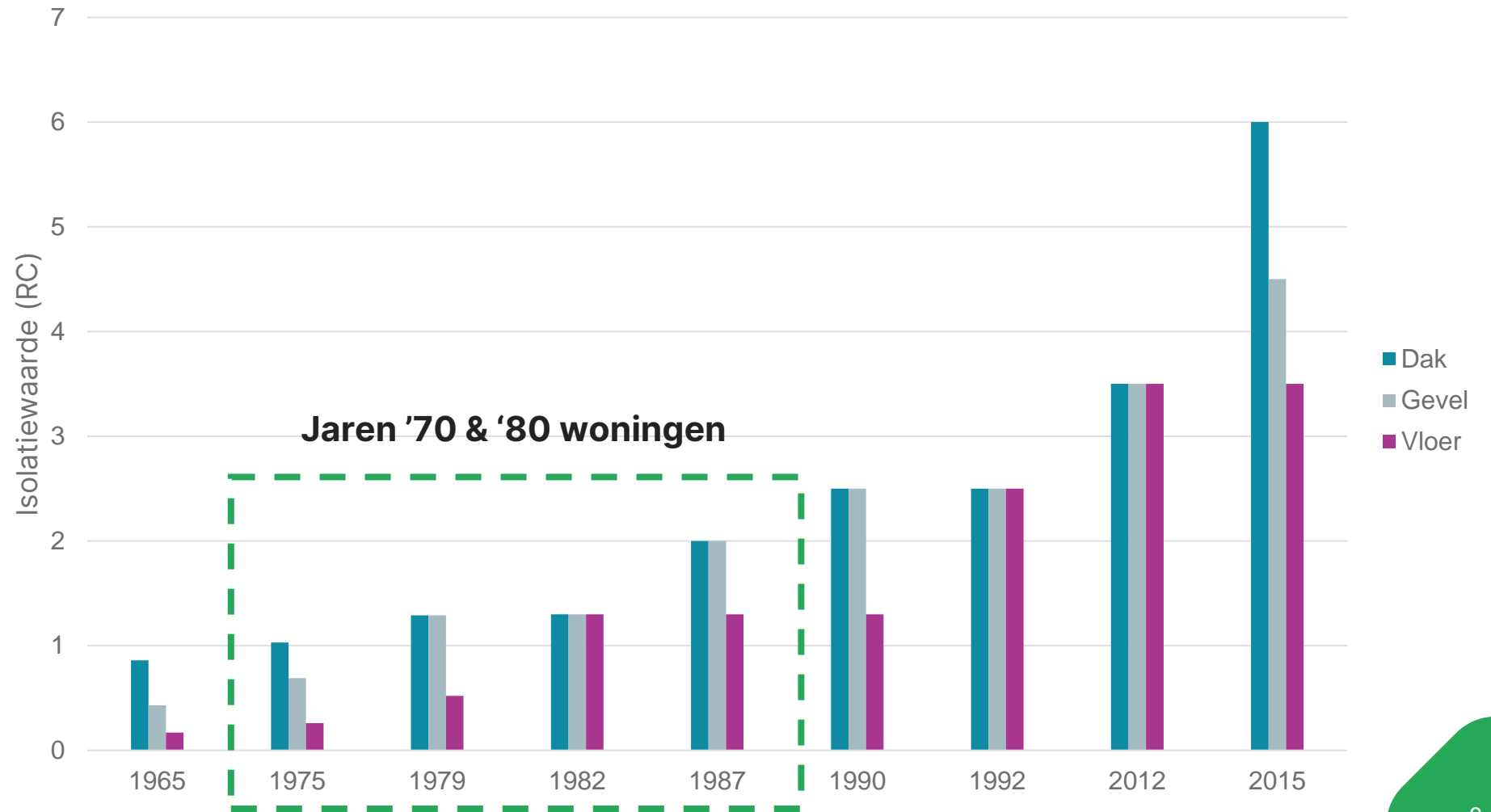

Ieder zo zijn motivatie



Milieu

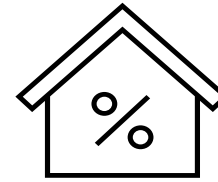

Woningwaarde

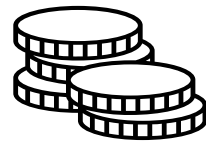

Lagere energierekening

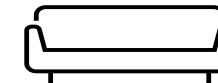

Comfort

Energierekening

Gasprijs van 2022

in euro per MWh



Wat kost energie?

Jaarlijkse energielasten PBL <i>22 cent per kWh en 1,20 euro per m³</i>		Jaarlijkse energielasten (met prijsplafond) <i>40 cent per kWh en 1,45 euro per m³</i>	
Maandbedrag	€ 165,-	Maandbedrag	€ 234,-
Jaarlijkse lasten	€ 1.980,-	Jaarlijkse lasten	€ 2.808,-
Totaal over 5 jaar	€ 10.512,-	Totaal over 5 jaar	€ 14.908,-
<i>Totaal over 15 jaar</i>	<i>€ 36.826,-</i>	<i>Totaal over 15 jaar</i>	<i>€ 52.226,-</i>

In de bovengelige berekeningen gaan wij uit van 3% inflatie.

Stapsgewijs naar aardgasvrij



Isoleren

Ventileren

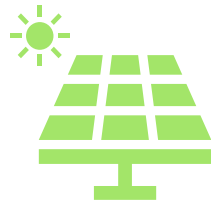

Elektriciteit

Verwarmen
en koelen



Warmteverlies doorsnee woning

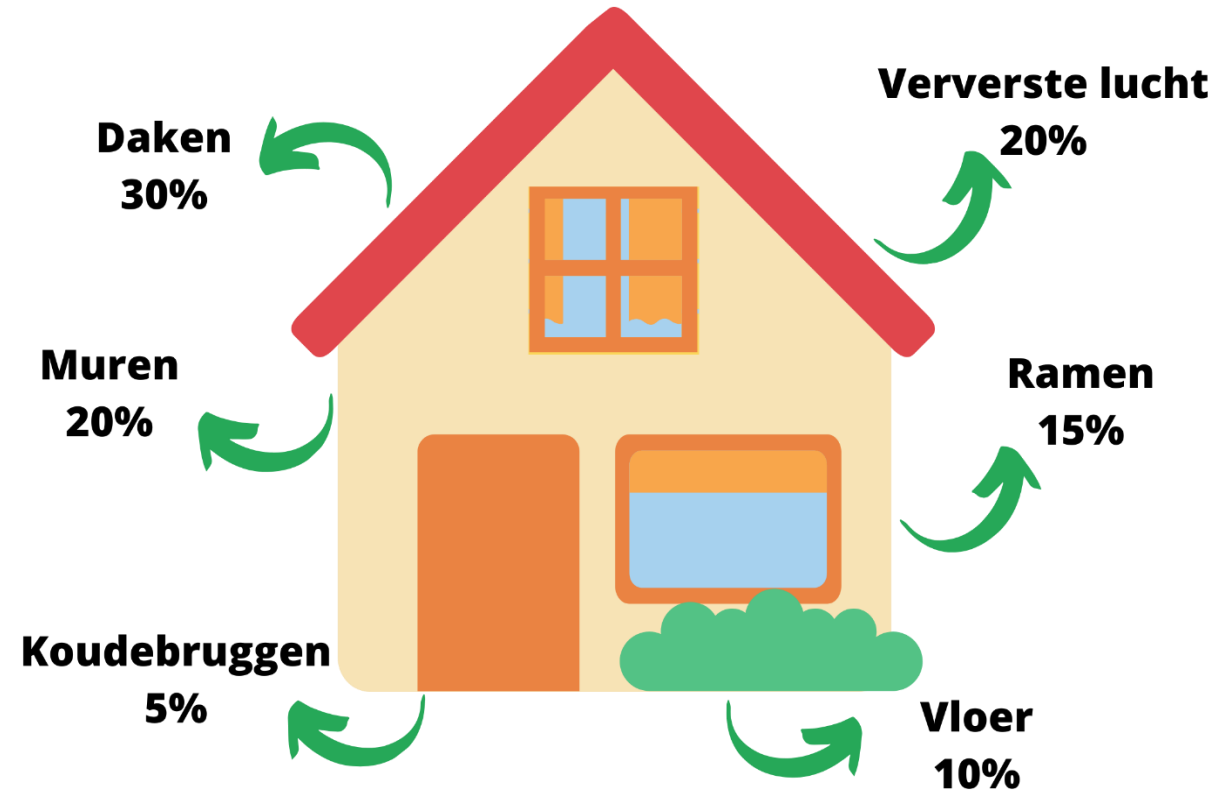

Welke vormen van isolatie?



Gevelisolatie



Dakisolatie



Vloerisolatie



Ramen en
deuren

Soorten gevelisolatie



Spouwmuurisolatie



Binnengevelisolatie



Buitengevelisolatie

Soorten gevelisolatie



Spouwmuurisolatie



Binnengevelisolatie



Buitengevelisolatie

Verschillende situaties

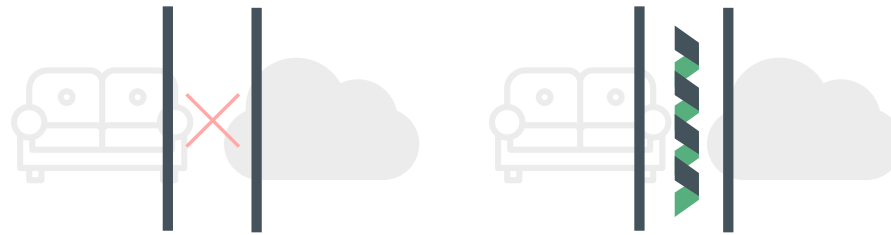

Tot **1975**

- Geen spouwmuurisolatie

Vanaf **1975**

- Matige spouwmuurisolatie
Rc 0,6

Vanaf **1990**

- Redelijk tot goede spouwmuurisolatie
Rc 2,5

Wat is een spouwmuur?



Hoe isoleren we een spouwmuur?



Controleren van de spouw



Minimale
spouwruimte



Vervuiling



Speciebaarden



Oude
isolatieresten



Vogels en
vleermuizen

Materialen



EPS parels



Minerale wol



UF schuim

€ 20,- tot € 30,-

Rekenvoorbeeld spouwmuurisolatie

Hoekwoning

Bouwjaar
woning 1970

Geveleppervlak
van 100 m²



Enmalige kosten	Enmalige subsidie	Terugverdientijd	Jaarlijkse besparing CO ₂
€ 2.000 - € 3.000	€ 800	2-3 jaar	Ca. 1.500 kg

Soorten vloer- en bodemisolatie



Vloerisolatie



Bodemisolatie



Renovatievloer

Soorten vloer- en bodemisolatie



Vloerisolatie



Bodemisolatie



Renovatievloer

Verschillende situaties



Tot **1982**

- Geen vloerisolatie

Vanaf **1982**

- Matige Vloerisolatie
Rc 1,3

Vanaf **1992**

- Redelijke Vloerisolatie
Rc 2,5

Manta en Kwaaitaal tot 1984



Wat doet bodemisolatie?

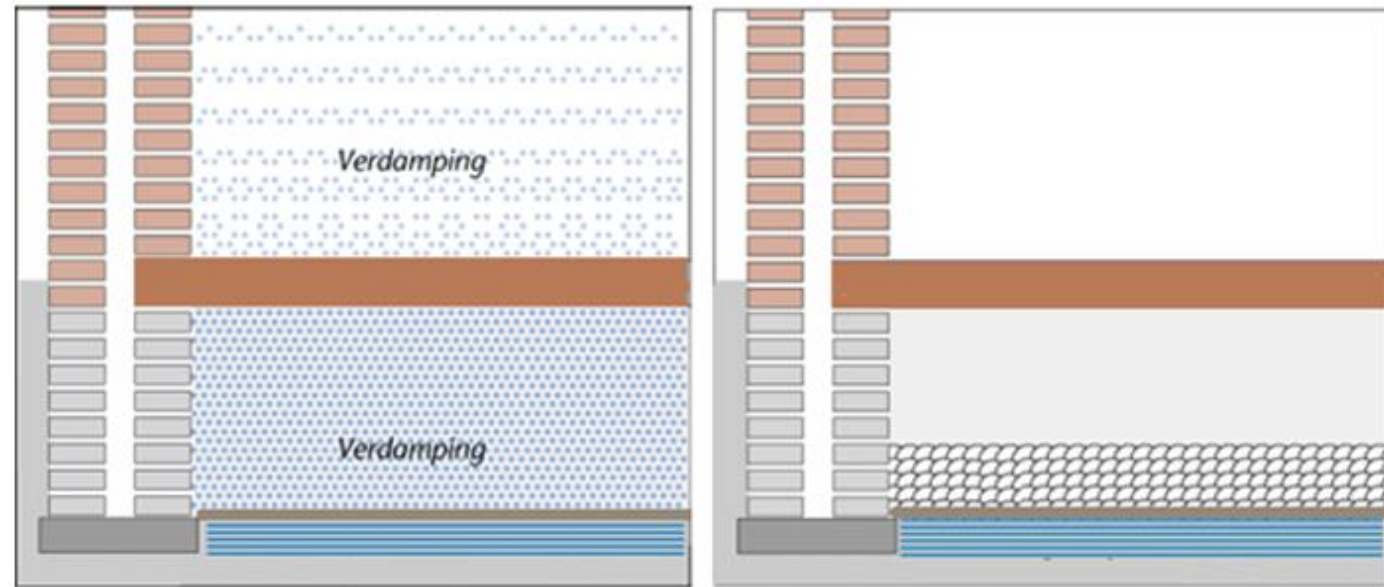

Materialen bodemisotatie



Isolatiewokkels



Isolatiematrassen



Schelpen



Bodemfolie



EPS parels

€ 25,- tot € 40,-

Materialen vloerisolatie



Thermoskussens



Prestatiefolie



Minerale wol



Opencellig PUR



Geslotencellig
PUR

€ 30,- tot € 50,-

Wanneer vloer- of bodemisolatie?

Kruipruimte	Lager dan 50 cm	Hoger dan 50 cm
Droge kruipruimte	Bodemisolatie	Vloerisolatie
Natte kruipruimte	Bodemisolatie	Bodem- of vloerisolatie

Vloerisolatie

Rekenvoorbeeld:

Tussenwoning

Bouwjaar
woning 1980

Vloeroppervlak
van 45 m²



Enmalige kosten	Enmalige subsidie	Terugverdientijd	Jaarlijkse besparing CO ₂
€ 1.500 - € 2.000	€ 495	6-8 jaar*	Ca. 500 kg

* Vloerverwarming

Soorten dakisolatie



Schuin dakisolatie
binnenzijde



Schuin dakisolatie
buitenzijde



Plat dakisolatie
binnenzijde



Plat dakisolatie
buitenzijde



Zoldervloerisolatie

Soorten dakisolatie



Schuin dakisolatie
binnenzijde



Schuin dakisolatie
buitenzijde



Plat dakisolatie
binnenzijde



Plat dakisolatie
buitenzijde



Zoldervloerisolatie

Verschillende situaties



Tot **1975**

- Geen Dakisolatie

Vanaf **1975**

- Matige Dakisolatie
Rc 1,3

Vanaf **1990**

- Redelijke Dakisolatie
Rc 2,5

Schuin dak, waar op letten?

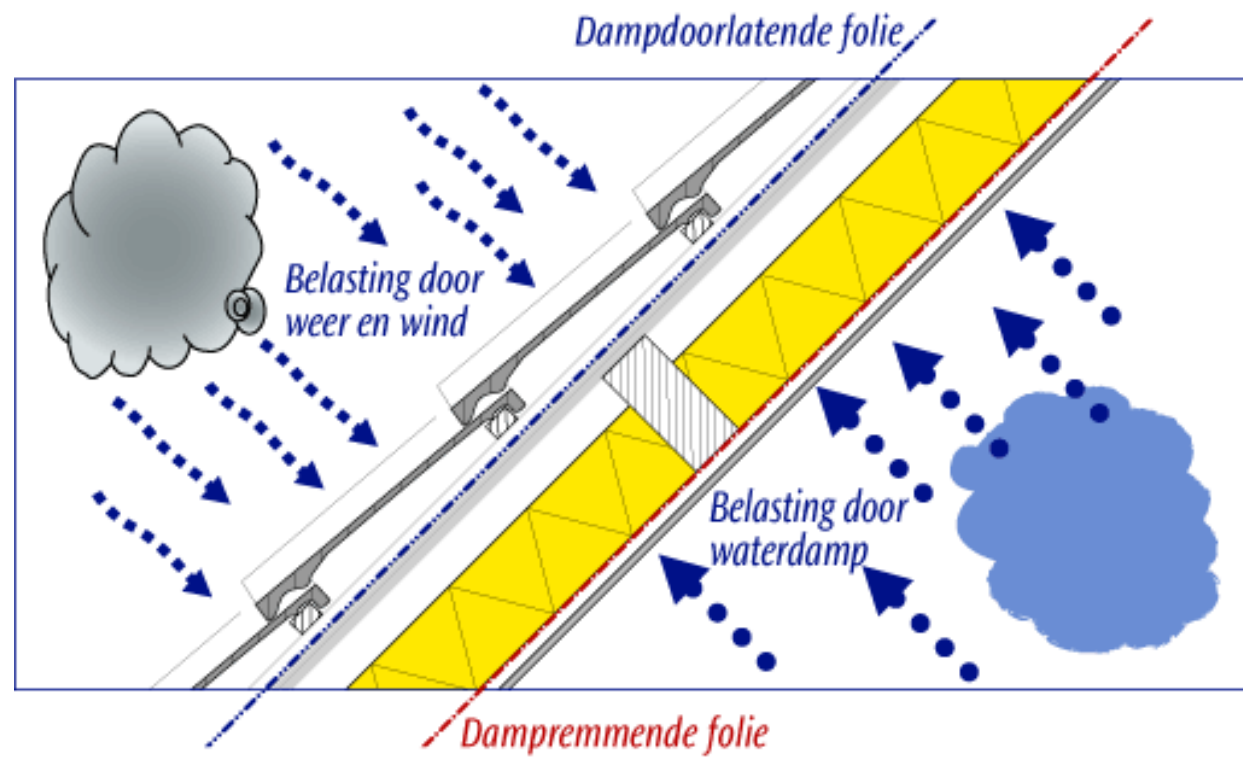

Schuin dak, waar op letten?

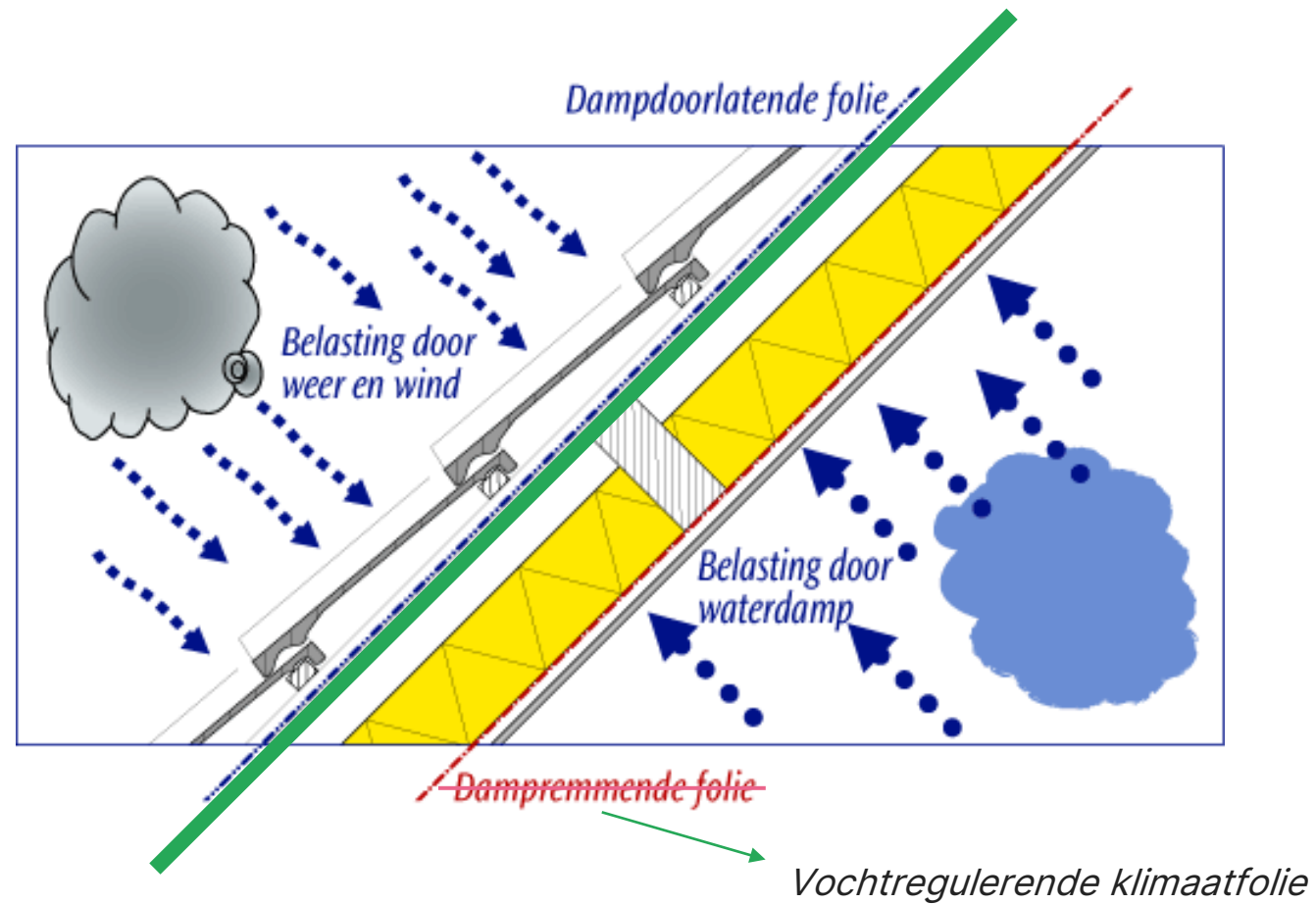

Plat dak, waar op letten?

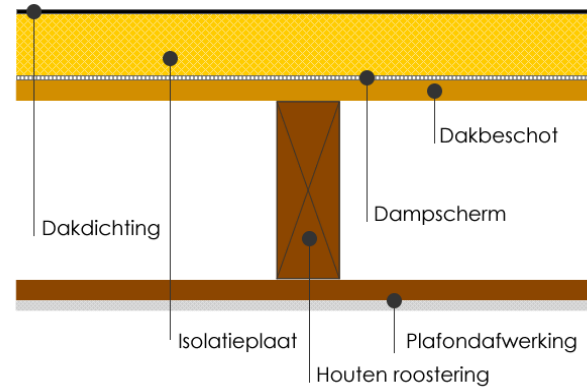

Warm dak isolatie
€ 40,- tot € 90,- per m²
Bij vernieuwen dakbedekking

Omgekeerde dak
constructie
€ 35,- tot € 50,- per m²
Dakbedekking
in goede staat

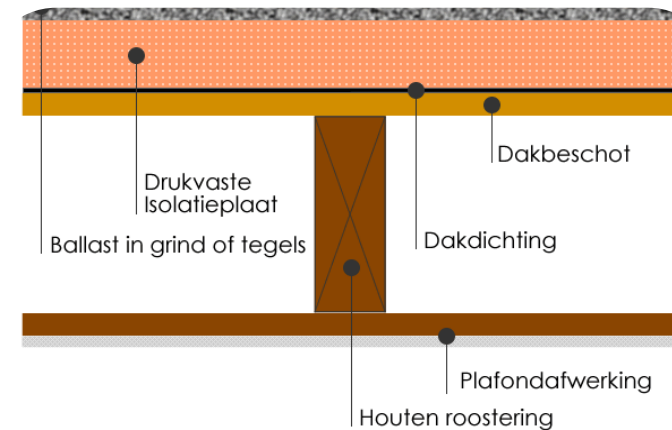

Schuin dakisolatie binnenzijde

Rekenvoorbeeld:

Tussenwoning

Bouwjaar
woning 1976

Dakoppervlak
van 60 m²



Enmalige kosten	Enmalige subsidie	Terugverdientijd	Jaarlijkse besparing CO ₂
€ 3.600 – € 6.000	€ 1.800	3-7 jaar	Ca. 1.000 kg

Verschillende situaties

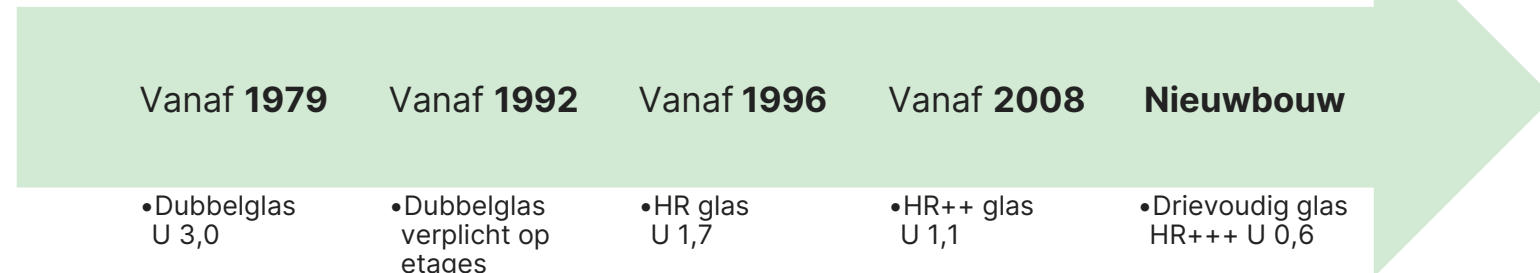
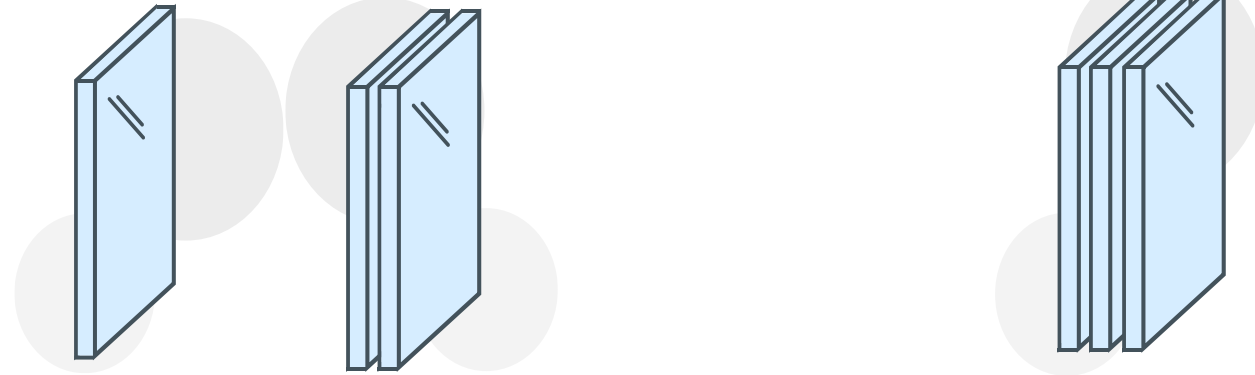

Soorten beglazing

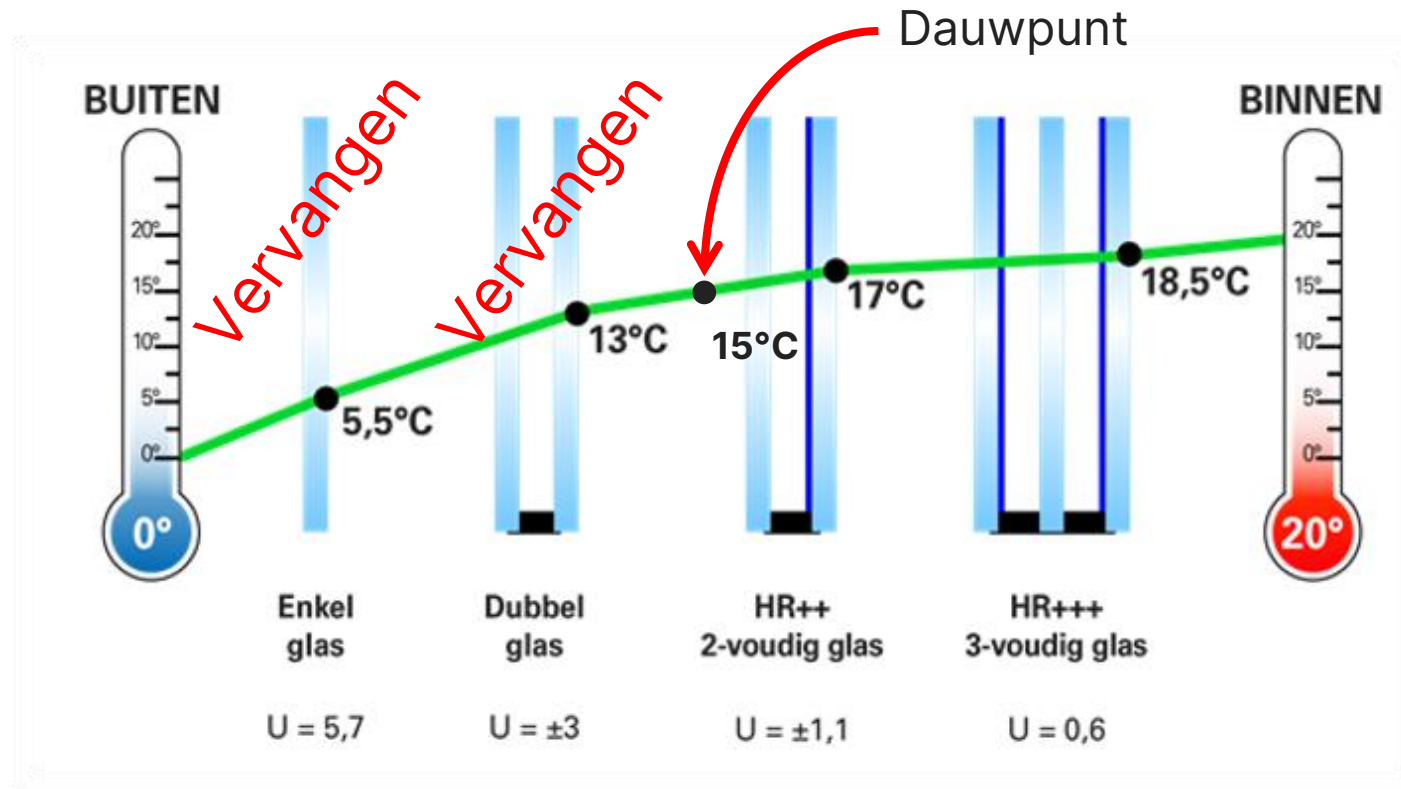

Beglazing controleren



Letters in de
aluminium strip



Weerkaatsing
van de vlam



Ventilatioeroosters

Rekenvoorbeeld glas

Hoekwoning

Bouwjaar
woning 1969

Glasoppervlak
van 14 m² op de
begane grond



Enmalige kosten	Enmalige subsidie	Terugverdientijd	Jaarlijkse besparing CO ₂
€ 2.380 – € 3.780	€ 644	7-12 jaar	Ca. 1.000 kg

Waarom is ventilatie belangrijk?

- 50% woningen onvoldoende geventileerd
- 10.800L lucht in per dag
- 20 uur per dag binnen

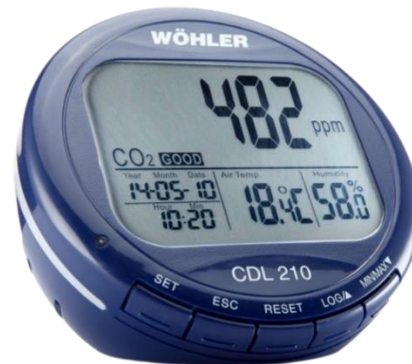

Parts per million	
5.000	Gevaarlijk
1.200	Ventileren
600-800	Gezond
350-400	Buiten

Natuurlijke ventilatie

- Handmatige sturing
- Weersafhankelijk



Mechanische afzuiging



Oud (voor 2006)

Energieslurper
Wisselstroom
Lawaaiig



Nieuw (na 2006)

CO₂ en vocht sturing (vaak) mogelijk

Balansventilatie

- Gereguleerde toe- en afvoer
- Warmteterugwinning
- Fijnstoffiltering
- Centraal en decentraal

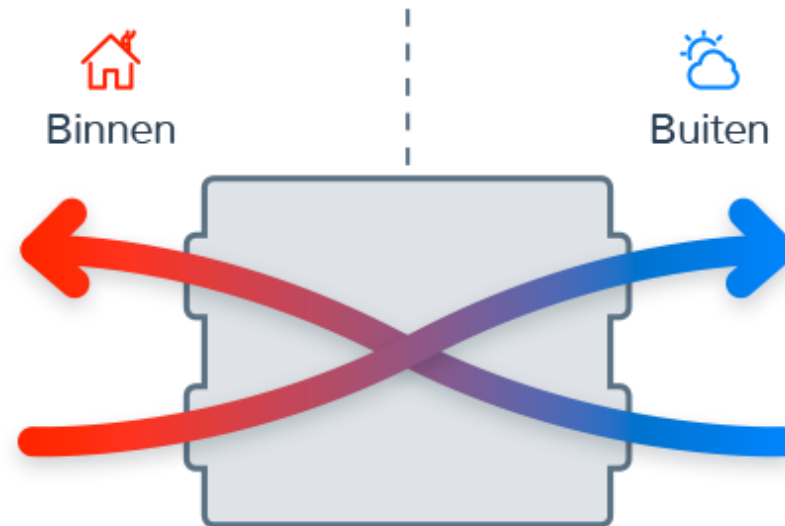

Decentrale balansventilatie

- Gereguleerde toe- en afvoer
- Warmteterugwinning
- Fijnstoffiltering
- Via lokale doorvoer
- Voor bijv. woonkamer



Zonnepanelen

- Omvormer
- Kabelroute
- Een derde van de energierekening is stroom

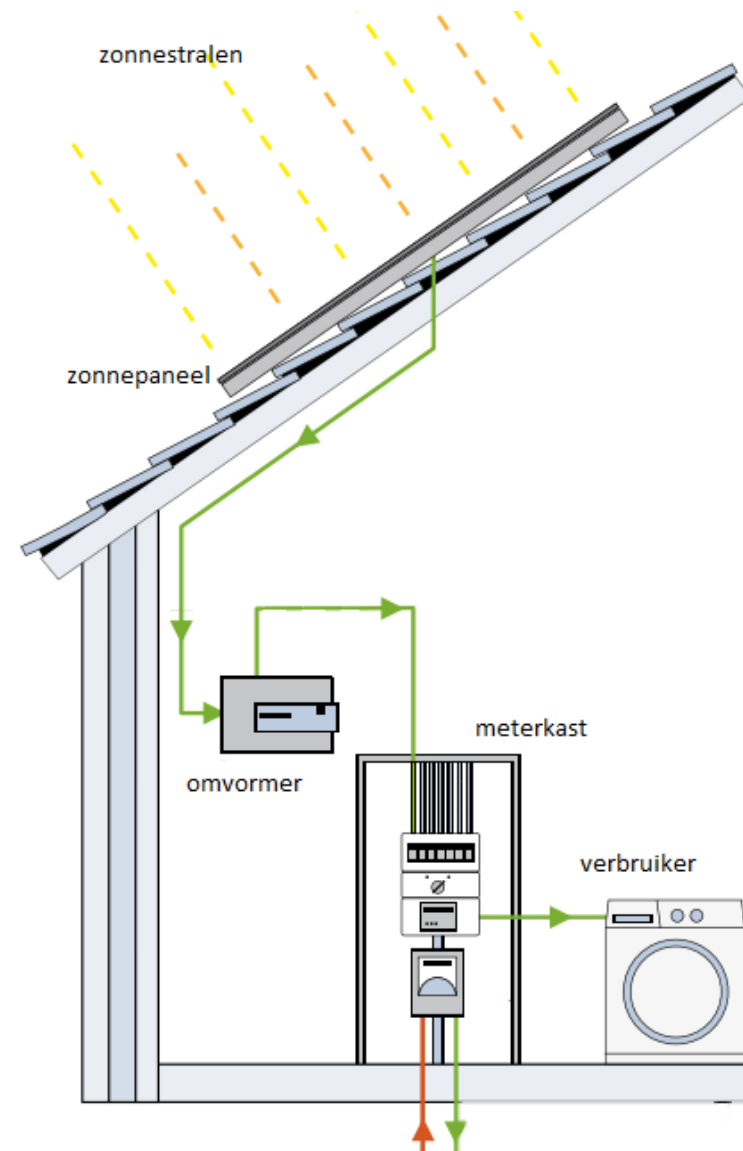

Rekenvoorbeeld zonnepanelen

Tussenwoning

3.500 kWh
stroomverbruik

10 panelen
3.800 Wp



Enmalige kosten Excl. btw	Subsidie	Terugverdientijd	Jaarlijkse besparing CO ₂
€ 5.000	0% btw materiaal en arbeid	5-7 jaar	Ca. 1.500 kg

Elektrisch koken



Lage temperatuur verwarming

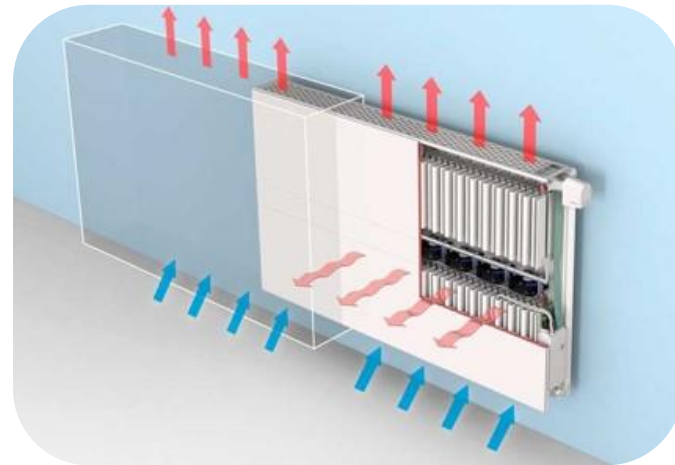

LTV Radiatoren



Vloerverwarming

Lage temperatuur verwarming

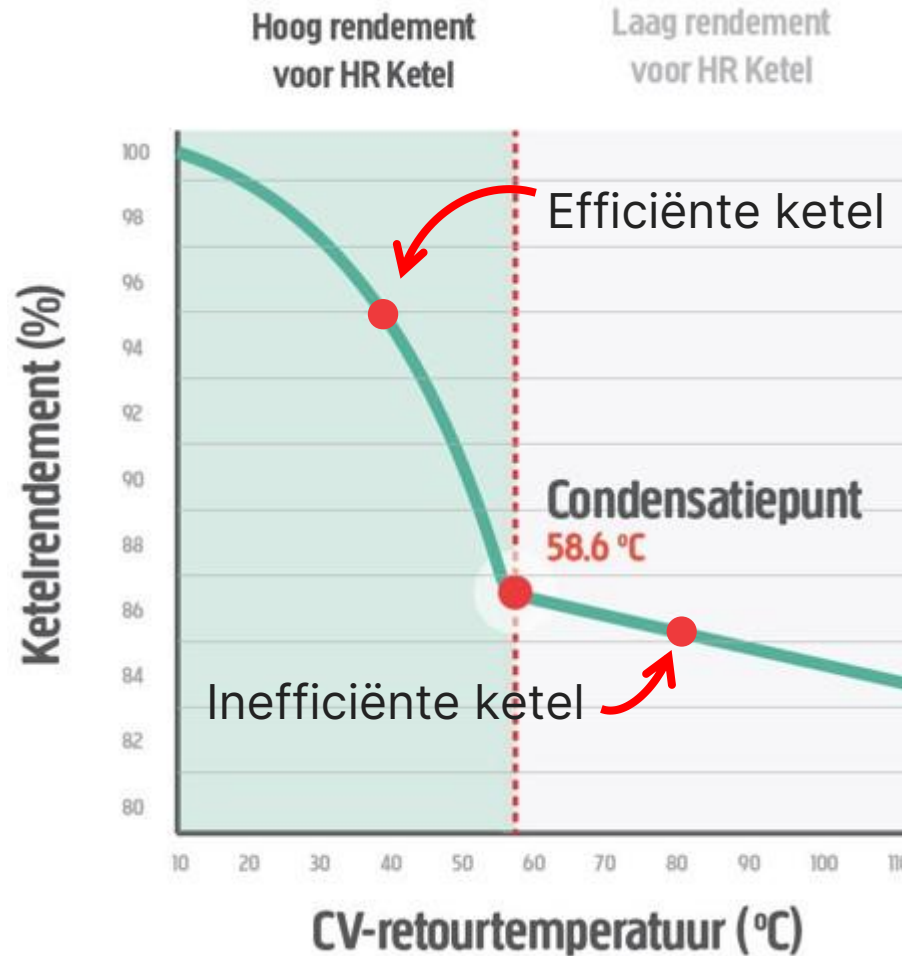

Verwarmen, collectief of individueel?



Collectief

Warmtenet
Groen gas
Waterstof
Etc.



Individueel

Warmtepomp
Elektrisch
Etc.

Rendement verwarmingssysteem

1 kW → HR cv-ketel → 1,07 kW

1 kW → Elektrische cv-ketel → 1 kW

1 kW → Warmtepomp → 2,5 - 6 kW

Soorten afgifte



Tapwater

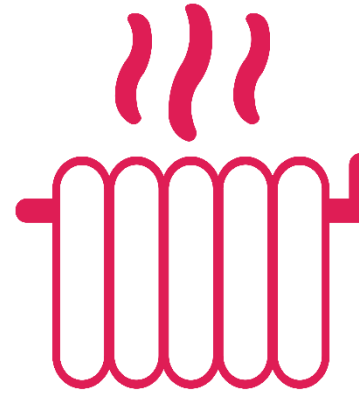

Verwarming



Koeling

Niet alles in één



Warmtepomp
boiler

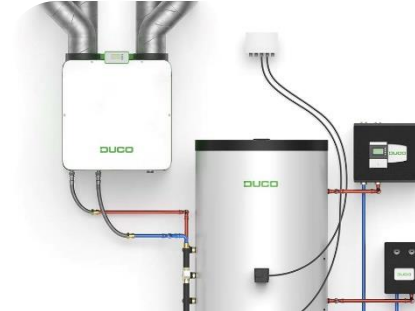

of



Ventilatie
warmtepomp



Hybride



Lucht-Lucht
(airco)

Niet alles in één



Warmtepomp
boiler

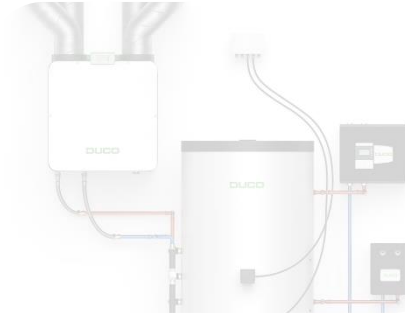

Ventilatie
warmtepomp



Hybride



Lucht-Lucht
(airco)



Hybride warmtepomp

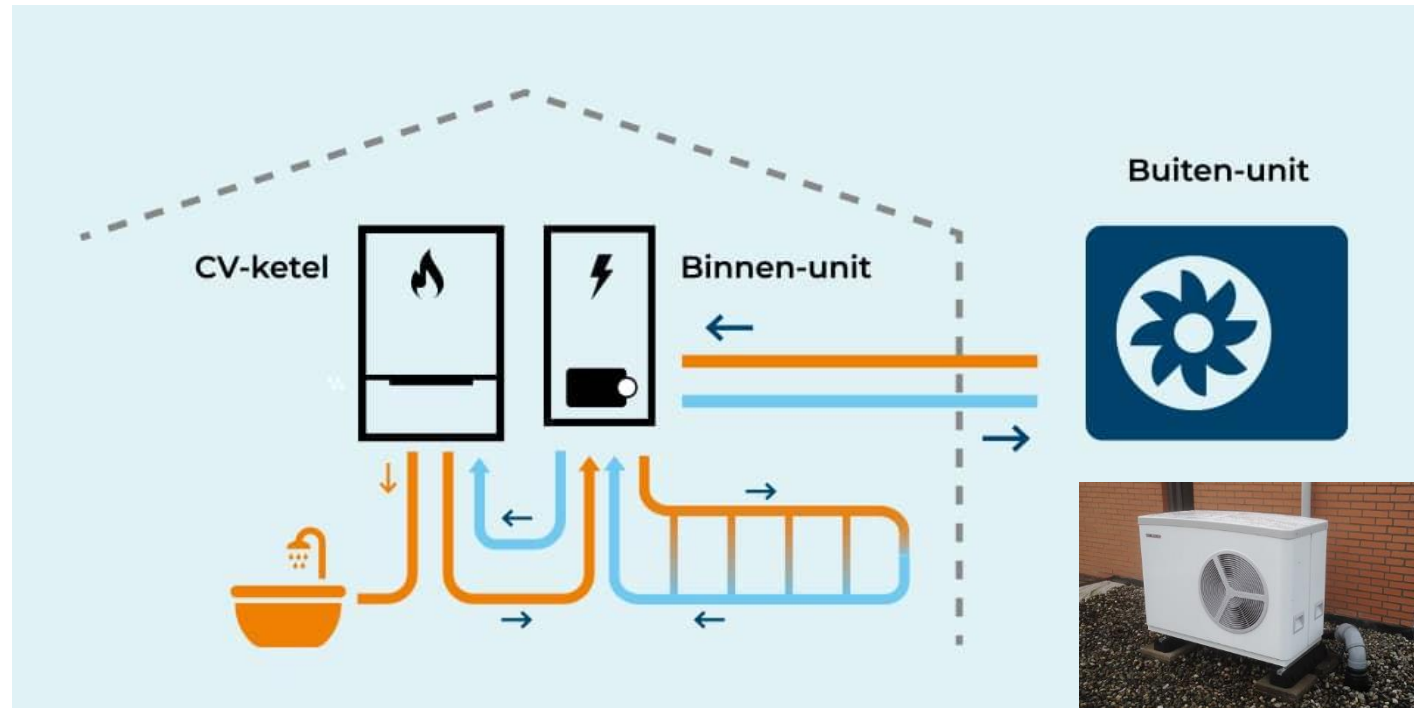



Hybride warmtepomp

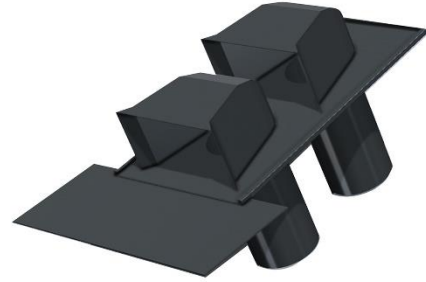

Zonder buitenunit



Alleen buitenunit



Buitenunit &
(kleine) binnenunit



Cv-ketel en
warmtepomp
geïntegreerd



Schaalbaar naar
all-electric

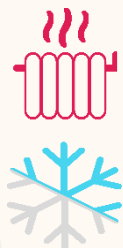

Hybride

Voordelen:

- 65% besparen op verwarmen
- Direct te combineren met cv-ketel
- Ook geschikt voor warmtenet

Nadelen:

- Levensduurverschillen, blijf je in de gascyclus?
- Alleen interessant bij een gasverbruik van $> 1.250 \text{ m}^3$
- Niet geschikt om van het gas te gaan
- Verder verduurzamen is financieel lastig
- Mogelijk vergunning buitenunit nodig



Hybride warmtepomp

Stroom € 0,22 per kWh
Gas € 1,20 per m³

**Rendement
SCOP 4,3**

Enmalige kosten	Enmalige subsidie	Voorwaarden
€ 5.000 - € 8.000	€ 2.200 - € 2.700	n.v.t.

Besparing	Gas ↓	Stroom ↑	Jaarlijkse besparing CO ₂
65% verwarming	750 m ³ € 900	1.500 kWh € 330	Ca. 350 kg

Alles in één



Lucht-Water



Water-Water

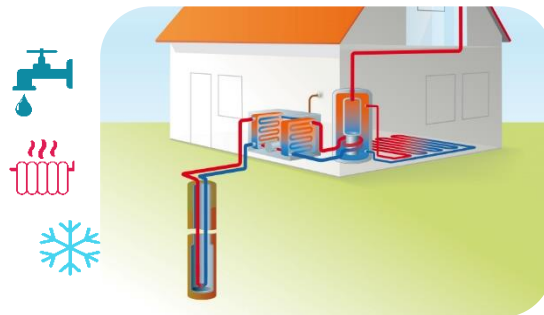

Bodem-
water



Zonlicht-
water (PVT)

Alles in één



Lucht-Water



Water-Water

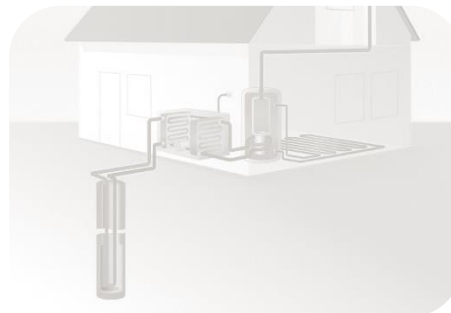

Bodem-
water



Zonlicht-
water (PVT)





Lucht-water warmtepomp





Lucht-water warmtepomp

Voordelen:

- 100% besparen op gas
- Afkoppelen en besparen vastrecht gas
- Alles in één oplossing
- Voordeligste optie over een periode van 15 jaar

Nadelen:

- Hoge investeringskosten
- LTV benodigd
- Lage SEER bij koelen
- Mogelijk vergunning buitenunit nodig



Lucht-water warmtepomp

**Rendement
SCOP 4,3**

Enmalige kosten	Enmalige subsidie	Voorwaarden
€ 12.500 - € 17.500	€ 2.400 - € 4.200	LTV

Besparing	Gas ↓	Stroom ↑	Jaarlijkse besparing CO ₂
100% gas + gasmeter	1.450 m ³ € 2.040	3.000 kWh € 726	Ca. 700 kg

Isolatieactie

- Kwaliteitsproducten
- Certificering Insula of SKG IKOB
- Brancheorganisatie VENIN
- Opvolging en doorlooptijd
 - Binnen 10 werkdagen contact
 - Binnen 6 weken een afspraak



Aanbod spouwmuurisolatie

Spouwmuur	
<i>Materiaal</i>	<i>Prijs</i>
EPS Parels	Voor actuele prijzen en actievoorwaarden verwijzen wij u graag naar de actiepagina op onze website
Minerale wol	

Aanbod vloer- en bodemisolatie

Vloerisolatie		
<i>Materiaal</i>	<i>Prijs</i>	
Reflectiefolie PIF60	Voor actuele prijzen en actievoorwaarden verwijzen wij u graag naar de actiepagina op onze website	
Thermoskussens		
Bodemisolatie		
<i>Materiaal</i>		
EPS Parels (20cm)		

Met wie werken we samen?



Subsidies en financieringen

Landelijk

Investering subsidie duurzame energie (ISDE)

Isolatie	€ 6,- t/m € 38,- p/m ²
Beglazing & kozijnen	€ 23,- t/m € 131,- p/m ²
Warmtepomp en zonneboiler	€ 750,- t/m € 3.800,-

Verlaagd BTW tarief

Arbeid op isolatie	9% BTW
--------------------	--------

BTW 0%

Zonnepanelen Particulieren	0% BTW
----------------------------	--------

Financieringsmogelijkheden

Energiebespaarlening	Max. € 25.000,-
----------------------	-----------------

Lokale initiatieven in Lisse

- Energiecoach aan huis

www.lisse.nl/energiecoach

www.degroenuitdaging.nl/energiecoach/energiecoach-lisse

Nieuwe Energiecoaches gezocht!

In Hillegom, Lisse en Teylingen start weer een nieuwe opleiding voor Energiecoaches! Interesse?
Aanmelden kan tot 20 maart.

Kijk op www.degroenuitdaging.nl/energiecoaches-gezocht

- Energiecoöperatie Lisse:

www.ec-lisse.nl

- Allemaal Duurzaam

www.allemaal-duurzaam.nl

Bedankt voor jouw aandacht!

Op de website van het Duurzaam Bouwloket kan je:

- Je in schrijven voor de [isolatie-acties](#);
- De [brochure te downloaden](#) om de samenvatting te lezen;
- De [digitale informatie avond](#) terug zien;
- De [subsidiecheck](#) doen;
- Door worden verwezen naar de [lokale initiatieven](#);
- Meer informatie op vragen over [energiebesparende maatregelen](#).

Bedankt voor jouw aandacht!



Einde



**DUURZAAM
BOUWLOKET**