



VOLVO V60



V60 MOMENTUM

The Volvo V60 Momentum variant offers a high specification level that includes an automatic rain sensor, power adjustable driver's seat with memory function, electric lumbar support, an active 8" TFT crystal driver's display, rear park assist, grocery bag holder, aluminium sill protector at the tailgate and bright decor trim around the side windows.

Variants:	Diesel	Petrol
	D4 Geartronic	T4 Geartronic
		T5 Geartronic

V60 INSCRIPTION

The Inscription variant is the ultimate upgrade. The combination of a power adjustable passenger seat, 3-spoke leather steering wheel with decor inlay, bright decor on the front spoiler and active bending Bi-Xenon headlights with headlight cleaning system enhances the level of luxury on this variant. A High Performance multimedia audio system with a 7" colour display screen, internet connectivity and Bluetooth® also come as standard.

Variants:	Diesel	Petrol
	D4 Geartronic	T4 Geartronic
	D5 Geartronic	T5 Geartronic
		T6 Geartronic AWD

V60 *R-DESIGN*

New 18" Ixion diamond cut alloy wheels together with the R-DESIGN chassis enhance the handling of this model. Visual presence is complemented with silver matt door mirrors, R-DESIGN unique rear exhaust pipes, sports seats with side support, R-DESIGN aluminium interior trim, unique R-DESIGN tread plates and a R-DESIGN sports leather steering wheel. A High Performance multimedia audio system with a 7" colour display screen, internet connectivity and Bluetooth® also come as standard.

Variants:	Diesel	Petrol
	D5 Geartronic	T6 Geartronic AWD





THE RIGHT EQUIPMENT. It is essential that your Volvo comes equipped with everything you need. Below you will find standard equipment for each model variant, plus optional equipment to personalise your Volvo V60. And as you would expect, there is an array of industry-leading, cutting edge safety innovations.

STANDARD EQUIPMENT - SAFETY AND SECURITY	Momentum	Inscription	R-DESIGN
City Safety	•	•	•
Dual stage driver and passenger airbags	•	•	•
Passenger airbag cut-off switch	•	•	•
SIPS (Side Impact Protection System)	•	•	•
Dual chamber SIPS airbags	•	•	•
IC (Inflatable Curtains)	•	•	•
WHIPS (Whiplash Protection System) (front seats)	•	•	•
ABS (Anti-lock Brake System) with EBD (Electronic Brake Distribution)	•	•	•
ESC (Electronic Stability Control)	•	•	•
5 x three point seat belts	•	•	•
Seat belt pre-tensioners (front and outer rear)	•	•	•
Head restraints - all 5 seats	•	•	•
ISOFIX attachment (rear seats)	•	•	•
Anti-theft alarm including immobiliser, volume and level sensor	•	•	•
IMS (Interior Movement Sensor)	•	•	•
Inner lock button with diode - driver and passenger doors	•	•	•
Key integrated remote control, central locking	•	•	•
Tinted windscreen	•	•	•
Headlight levelling system	•	•	•
Side marker illumination	•	•	•
Adaptive brake lights including high level LED brake light	•	•	•
Power parking brake	•	•	•
IDIS (Intelligent Driver Information System)	•	•	•
Home safe and approach lighting	•	•	•
Power child locks (rear doors)	•	•	•
Warning triangle	•	•	•
LED daytime running lights	•	•	•
Soft load cover	•	•	•
Load protection net in cargo area	•	•	•
Laminated side windows	•	•	•

STANDARD EQUIPMENT - EXTERIOR	Momentum	Inscription	R-DESIGN
16" Hera silver wheels - 215/55 R16 W tyres (T4)	•	•	
17" Pallene silver wheels - 215/50 R17 W tyres (D4 and T5)	•	•	
18" Titania diamond cut wheels - 235/40 R18 Y tyres (D5 and T6)			
18" Ixion III matt black diamond cut wheels - 235/40 R18 Y tyres (R-DESIGN)			•
Tempa spare wheel with jack kit	•	•	•







STANDARD EQUIPMENT – EXTERIOR Continued	Momentum	Inscription	RDESIGN
Rain sensor - automatic windscreen wiper activation	•	•	•
Auto-folding power door mirrors with ground lights	•	•	•
Power adjustable and heated door mirrors	•	•	•
Active bending Bi-Xenon headlights with headlight cleaning system		•	•
Colour co-ordinated door mirrors and bumpers	•	•	
Visible twin exhaust pipes (T4)	•	•	
Dual integrated exhaust pipes (D4, T5, D5 and T6)	•	•	
Bright décor trim around side windows – upper and lower	•	•	
Bright roof rails	•	•	•
Rear park assist	•	•	•
Dynamic chassis	•	•	
RDESIGN Sport grille with logo			•
RDESIGN Sport chassis			•
RDESIGN Bright décor trim around side windows – upper and lower			•
RDESIGN Silver matt door mirrors			•
RDESIGN Rear spoiler			•
RDESIGN Full body kit (front and rear spoilers, side skirts, body colour wheel arch mouldings and unique tail pipes)			•

STANDARD EQUIPMENT – INTERIOR	Momentum	Inscription	RDESIGN
ECC (Electronic Climate Control)	•	•	•
CZIP (CleanZone Interior Package)	•	•	•
AQS (Air Quality System)	•	•	•
Pollen filter	•	•	•
B-pillar ventilation	•	•	•
Cruise control	•	•	•
Information centre	•	•	•
Front and rear power windows	•	•	•
Illuminated driver and passenger vanity mirrors	•	•	•
Frameless auto-dimming rearview mirror	•	•	•
Front and rear reading lights	•	•	•
Front centre armrest with cup holders	•	•	•
Front and rear ashtray with cigarette lighter	•	•	•
Grocery bag holder	•	•	
12V sockets (front and cargo area)	•	•	•
Height adjustable driver and passenger seats	•	•	•
Power driver seat with memory function and electric lumbar support	•	•	•
Manually adjustable passenger seat, 6-way	•	n/a	•
Power passenger seat		•	
Versatile split folding rear seat (40%/20%/40%)	•	•	•
Leather steering wheel, 3-spoke	•		
Leather steering wheel with aluminium inlay, 3-spoke		•	
Steering wheel remote audio controls	•	•	•





STANDARD EQUIPMENT - INTERIOR Continued

	Momentum	Inscription	RDESIGN
Height and reach adjustable steering column	●	●	●
Active TFT crystal driver's display	●	●	
Standard leather seats	●	●	
Leather gear knob	●	●	
Gear knob illumination	●	●	●
Interior lighting – mid level	●	●	●
Chrome rotary knobs	●	●	●
Chrome trim around air vents and light switch module	●	●	●
Milled brushed aluminium trim	●	●	n/a
Aluminium sill protector - tailgate	●	●	●
Luxury floor mats	●	●	
Performance Sound audio system – 1 x CD/radio, 4 x 20W amplifier, aux. input (MP3/WMA compatible), 6 speakers and a 5" colour display screen	●		
High Performance multimedia & connectivity audio system – 1 x DVD/radio, 4 x 40W amplifier, Bluetooth®, USB and aux. input (MP3/WMA compatible), 8 speakers and a 7" colour display screen – including connected service booking		●	●
 Digital crystal driver's display			●
 Aluminium sport pedals			●
 Sports gear knob			●
 Leather sport steering wheel with aluminium inlays and logo			●
 Sport seats with side support			●
 Deco aluminium trim			●
 Sports design floor mats			●

*** OPTIONAL EQUIPMENT - SAFETY AND SECURITY**

	Price incl. 14% VAT	Momentum	Inscription	RDESIGN
BLIS (Blind Spot Information System) with Cross Traffic Alert (CTA)	R8,250.00	○	○	○
LDW (Lane Departure Warning) with DAC (Driver Alert Control) and forward collision warning system (camera) and LKA (Lane Keeping Aid) (i)	R9,750.00	○	○	○
Pedestrian and cyclist detection with ACC (Adaptive Cruise Control) with distance alert, queue assist and collision warning with full auto brake (i) (iv)	R19,000.00	○	○	○
PCC (Personal Car Communicator) with Keyless Drive	R5,650.00	○	○	○
First-aid kit	R315.00	○	○	○
Park assist front and rear	R2,850.00	○	○	○
Park assist pilot including park assist front and rear	R7,000.00	○	○	○
Rear parking camera	R9,300.00	○	○	○

*** OPTIONAL EQUIPMENT - INTERIOR**

	Price incl. 14% VAT	Momentum	Inscription	RDESIGN
Electric power steering (Normal, City and Sport)	R2,750.00	○	○	○
Power glass tilt and slide sunroof	R8,500.00	○	○	○
Humidity sensor	R1,275.00	○	○	○
Grocery bag holder	R800.00	●	●	○
Sport leather seats with side support	R6,000.00	○	○	n/a
Power passenger seat	R4,500.00	○	●	○

Continued overleaf

* OPTIONAL EQUIPMENT - INTERIOR Continued	Price incl. 14% VAT	Momentum	Inscription	R-DESIGN
Leather steering wheel with décor inlay, 3-spoke	R850.00	o	●	o
Quick foldable backrest, passenger seat (not with sport leather seats)	R375.00	o	o	n/a
Black carpet kit for beige interiors	no cost	o	o	n/a
Heated front seats	R1,850.00	o	o	o
Heated rear seat (ii)	R1,850.00	o	o	o
Power folding rear headrests	R900.00	o	o	o
Sunglasses holder	R315.00	o	o	o
Aluminium décor inlays	no cost	o	o	n/a
Urbane wood trim	R4,350.00	o	o	n/a
Piano black décor inlay	R2,250.00	o	o	n/a
Integrated 2-stage booster cushions	R2,800.00	o	o	o
Gearshift paddles (vi)	R1,850.00	o	o	o
High Performance multimedia and connectivity audio system – 1 x DVD/radio, 4 x 40W amplifier, Bluetooth®, USB and aux. input (MP3/WMA compatible), 8 speakers and a 7" colour display screen – including connected service booking	R10,600.00	o	●	●
Harman Kardon Premium Sound multimedia and connectivity audio system, 1 x DVD/radio, 5 x 130W amplifier, Bluetooth®, USB and aux. input (MP3/WMA compatible), 12 speakers and a 7" colour display screen – including connected service booking	R15,600.00	o	o	o
Remote control for audio system (iii)	R1,200.00	o	o	o
Navigation system with RTTI and TMC	R10,500.00	o	o	o
Interior lighting - high level	R850.00	o	o	o
Auto dimming rearview mirror with compass	R1,275.00	o	o	o

* OPTIONAL EQUIPMENT - EXTERIOR	Price incl. 14% VAT	Momentum	Inscription	R-DESIGN
Metallic paint	R2,500.00	o	o	o
17" Pallene silver wheels – 215/50 R17 W tyres (std on D4, T5 and no cost on D5, T6)	R7,500.00	o	o	n/a
17" Rodinia glossy black accessory wheels	R12,000.00	o	o	n/a
18" Skadi silver bright wheels – 213/40 R18 Y tyres (no cost on D5, T6)	R7,500.00	o	o	n/a
18" Titania diamond cut wheels – 213/40 R18 Y tyres (std on D5, T6)	R7,500.00	o	o	n/a
18" Modin iron stone diamond cut accessory wheels (no cost on D5 and T6)	R12,000.00	o	o	n/a
18" Freja dark grey diamond cut accessory wheels (no cost on D5 and T6)	R12,000.00	o	o	n/a
19" Ixion IV matt black diamond cut wheels – 235/40 R19 Y tyres (R-Design)	R7,500.00	n/a	n/a	o
19" Artio tech matt grey diamond cut accessory wheels (v)	R12,000.00	o	o	n/a
19" Portia silver wheels – 235/40 R19 Y tyres (v)	R7,500.00	o	o	n/a
19" Portia black diamond cut wheels – 235/40 R19 Y tyres (v)	R7,500.00	o	o	n/a
Lockable wheel nuts	R800.00	o	o	o
Dual integrated exhaust tail pipes (standard on D4, T5, D5, T6)	R2,200.00	o	o	n/a
Comfort chassis	no cost	o	o	n/a





* OPTIONAL EQUIPMENT - EXTERIOR Continued	Price incl. 14% VAT	Momentum	Inscription	REDESIGN
Sport chassis	R5,100.00	o	o	●
Active bending Bi-Xenon headlights with headlight cleaning system	R8,500.00	o	●	●
Heated windscreen washer nozzles	R800.00	o	o	o
Infrared reflective windscreen	R4,950.00	o	o	o
Automatic dimming inner/outer side mirrors	R1,750.00	o	o	o
Bright work décor, front spoiler, LH and RH side	R1,200.00	o	●	n/a

● = standard; o = option; n/a = not available; * Fitted at factory .

- (i) Not in conjunction with IR (Infrared) reflective windscreen.
- (ii) Must be ordered in conjunction with heated front seats.
- (iii) Must be ordered in conjunction with High Performance multimedia audio or Premium Sound multimedia audio systems (7" colour display screen).
- (iv) Only in combination with LDW (Lane Departure Warning) system.
- (v) Only in combination with sport chassis.
- (vi) Only in combination with 3-spoke leather steering wheel with chrome décor inlay.

Prices are inclusive of 14% VAT	Momentum	Inscription	R _{DESIGN}
V60 SPORT PACK - T4, D4, T5	R 28,500.00	n/a	n/a
Headlamp cleaners	o		
Lockable wheel nuts	o		
Dynamic bending lights (Bi-Xenon)	o		
Park assist - front and rear	o		
18" Titania diamond cut wheels (Swop for Freja, Modin, Pallene, Skadi, Rodinia)	o		
Leather steering wheel with décor inlay, 3-spoke	o		
Bright work décor, front spoiler, LH and RH side	o		
Electric power steering, personalization	o		
High Performance Sound Multimedia DVD and Connectivity,			
Bluetooth®, AUX, USB and 8 loud speakers	o		
V60 SPORT PACK - T4, D4, T5	n/a	R 17,500.00	n/a
Lockable wheel nuts		o	
PCC with Keyless Drive		o	
Park assist - front and rear		o	
18" Titania diamond cut wheels (Swop for Freja, Modin, Pallene, Skadi, Rodinia)		o	
Electric power steering, personalization		o	
V60 SPORT PACK - D5, T6	n/a	R 22,500.00	n/a
Sport chassis		o	
Lockable wheel nuts		o	
PCC with Keyless Drive		o	
Park assist - front and rear		o	
Gearshift paddles		o	
Electric power steering, personalization		o	
19" Artio tech matt grey diamond cut wheels (Swop for Portia Black, Portia Silver)		o	
V60 TECHNO PACK - T4, D4, T5	R 43,500.00	n/a	n/a
Power passenger seat	o		
Heated front seats	o		
Headlamp cleaners	o		
Navigation system with RTTI and TMC	o		
PCC with Keyless Drive	o		
Dynamic Bending Lights (Bi-Xenon)	o		
Park assist - front and rear	o		
18" Titania diamond cut wheels (Swop for Freja, Modin, Pallene, Skadi, Rodinia)	o		
Electric power steering, personalization	o		
High Performance Sound Multimedia DVD and Connectivity,			
Bluetooth®, AUX, USB and 8 loud speakers	o		

Prices are inclusive of 14% VAT	Momentum	Inscription	R _{DESIGN}
V60 TECHNO PACK - T4, D4, T5	n/a	R 27,250.00	n/a
Heated front seats		o	
Navigation system with RTTI and TMC		o	
PCC with Keyless Drive		o	
Park assist - front and rear		o	
18" Titania diamond cut wheels (Swop for Freja, Modin, Pallene, Skadi, Rodinia)		o	
Electric power steering, personalization		o	
V60 TECHNO PACK - D5, T6	n/a	R 22,250.00	n/a
Heated front seats		o	
Navigation system with RTTI and TMC		o	
PCC with Keyless Drive		o	
Park assist - front and rear		o	
Electric power steering, personalization		o	
V60 PREMIUM PACK - T4, D4, T5	R 46,000.00	n/a	n/a
Power passenger seat	o		
Heated front seats	o		
Headlamp cleaners	o		
Navigation system with RTTI and TMC	o		
PCC with Keyless Drive	o		
Dynamic bending lights (Bi-Xenon)	o		
Park assist - front and rear	o		
18" Titania diamond cut wheels (Swop for Freja, Modin, Pallene, Skadi, Rodinia)	o		
Electric power steering, personalization	o		
Premium Sound by Harman Kardon / AUX / USB /			
Bluetooth® / 12 x speakers	o		
V60 PREMIUM PACK - T4, D4, T5	n/a	R 30,250.00	n/a
Heated front seats		o	
Navigation system with RTTI and TMC		o	
PCC with Keyless Drive		o	
Park assist - front and rear		o	
18" Titania diamond cut wheels (Swop for Freja, Modin, Pallene, Skadi, Rodinia)		o	
Electric power steering, personalization		o	
Premium Sound by Harman Kardon / AUX / USB /			
Bluetooth® / 12 x speakers		o	

Prices are inclusive of 14% VAT	Momentum	Inscription	R-DESIGN
V60 PREMIUM PACK - D5, T6	n/a	R 25,750.00	n/a
Heated front seats		o	
Navigation system with RTTI and TMC		o	
PCC with Keyless Drive		o	
Park assist - front and rear		o	
Electric power steering, personalization		o	
Premium Sound by Harman Kardon / AUX / USB / Bluetooth® / 12 x speakers		o	
V60 R-DESIGN PLUS	n/a	n/a	R 21,250.00
Power passenger seat			o
Heated front seats			o
Lockable wheel nuts			o
PCC with Keyless Drive			o
Park assist - front and rear			o
Gearshift paddles			o
Electric power steering, personalization			o
Interior theatre lighting - high version			o
19" Ixion IV black diamond cut wheels (Swop for 18" Ixion III matt black diamond cut)			o
V60 R-DESIGN PREMIUM PLUS	n/a	n/a	R 33,750.00
Power passenger seat			o
Heated front seats			o
Navigation system with RTTI and TMC			o
Lockable wheel nuts			o
PCC with Keyless Drive			o
Park assist - front and rear			o
Gearshift paddles			o
Electric power steering, personalization			o
Interior theatre lighting - high version			o
19" Ixion IV black diamond cut wheels (Swop for 18" Ixion III matt black diamond cut)			o
Premium Sound by Harman Kardon / AUX / USB / Bluetooth® / 12 x speakers			o
V60 DRIVER SUPPORT PACK	R 28,500.00	R 28,500.00	R 28,500.00
Auto dimming inner and outer mirrors	o	o	o
Blind Spot Information System	o	o	o
Driver Alert System and Lane Keeping Aid	o	o	o
ACC + Collision Warning with Auto Braking	o	o	o

o = option; n/a = not available









“Sensus is our way of enabling you to communicate instinctively with your car, and keep you connected with your digital world.”

YOU'RE IN CONTROL, NATURALLY.

SENSUS

We have designed a gorgeous space around the driver. All of our instruments and controls are intuitive and easy to use. We call this approach of connecting you and your car with the world around you, “Sensus”.

You can also choose between three unique instrument cluster modes to customize your driving experience even further.

The Sensus screen is a multimedia hub, giving you immediate connectivity to information and entertainment at your fingertips.



City Safety functions at speeds up to 50 km/h. This system can help prevent a collision if the difference in speed between your vehicle and the vehicle ahead is less than 15 km/h.

We've further improved our optional Blind Spot Information System (BLIS). It now uses radar technology to alert you to vehicles closing up in your blind spot. There's also Cross Traffic Alert, which watches out for vehicles you can't see when you're reversing out of tight parking spaces.

Because we care about other road-users just as much as you, Pedestrian and Cyclist Detection with Full Auto-Brake watches out for pedestrians and cyclist in your path and applies the brakes if you're unable to react in time.

“Relax and let your Volvo do the hard work for you.”

“Our Drive-E powertrains give you an exhilarating driving experience with smooth, instant response and a reduced environmental impact.”

COMMITTED TO SAFETY.

SUSTAINABLE DRIVING IS EXCITING.

INTELLISAFE

Since the birth of Volvo Cars in 1927, keeping you safe has been part of our DNA. We have pioneered safety advances and invented life-saving technologies, such as the three-point safety belt. We have also equipped all of our cars with safety cages and laminated windscreens since 1944. In 1976, we developed the catalytic converter and the lambda sond, a sensor that monitors exhaust gas, reducing emissions and boosting performance as well as economy.

Today, we are building cars that actively scan the area around you, looking out for the unexpected. Volvo pioneered City Safety, a low-speed collision avoidance technology that helps prevent collisions at speeds up to 50 km/h. We were the world's first car manufacturer to include this feature as standard equipment in all new models.

We also developed Pedestrian Detection, a system that detects pedestrians and brakes

the car when necessary, and we will not stop there.

Tracker Connect provides access to roadside assistance and emergency support at the touch of a button. Also included is automatic collision alert, which notifies a trained operator to contact the vehicle and send emergency service as soon as a collision is detected. In the future, our aim is to design cars that will prevent collisions with other road users altogether.

DRIVE-E

At the heart of every Volvo car we make is our approach to sustainable driving and innovative thinking. We offer a range of technologies that give you greater efficiency and lower running costs.

Our Drive-E powertrains combine the low fuel consumption and emissions of a four cylinder engine with the performance of a six or eight cylinder engine. The result is a smooth, powerful drive, with fewer stops at the pumps. We also offer an interior Air Quality System that checks incoming air for pollutants and closes the vents when necessary – we call this CleanZone. An active carbon filter helps

protect you from harmful gases and unpleasant odors, so you can breathe happy and healthy.

At Volvo Cars, we always strive to make our manufacturing process sustainable. All of the electricity for our factories in Sweden and Belgium comes from clean hydro-electric or wind power. Environmentally-aware mobility is central to our philosophy of intelligent, thoughtful luxury.



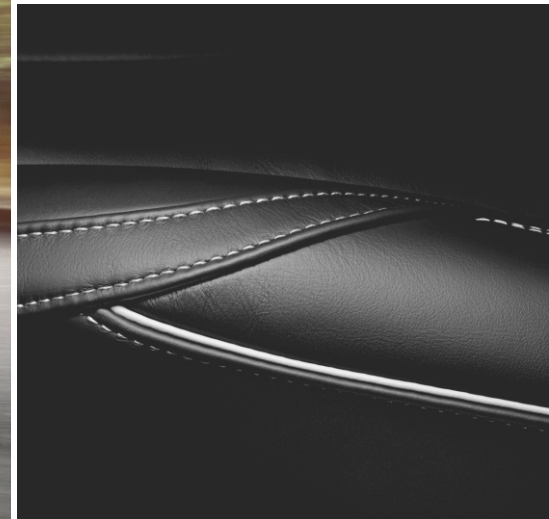

Proud sponsor of the unfair advantage

Choose the Volvo V60 R-DESIGN variant and the V60 receives a first class attitude adjustment – inside and out. Boldly provocative yet tastefully reserved, the exclusive R-DESIGN styling elements and special chassis express a definitive passion for sport. From its aggressive prow with larger intakes to the rear diffuser with dual tailpipes, the Volvo V60 R-DESIGN exudes confidence at every turn.

There are times in life when you have to turn up the volume. The V60 R-DESIGN dials up the physical and emotional dynamics beautifully. Outstanding R-DESIGN elements include: five-spoke diamond cut 18" Ixion wheels, specially stitched R-DESIGN sport seats and an exclusive leather three-spoke steering wheel with a stamped metal R-DESIGN badge.

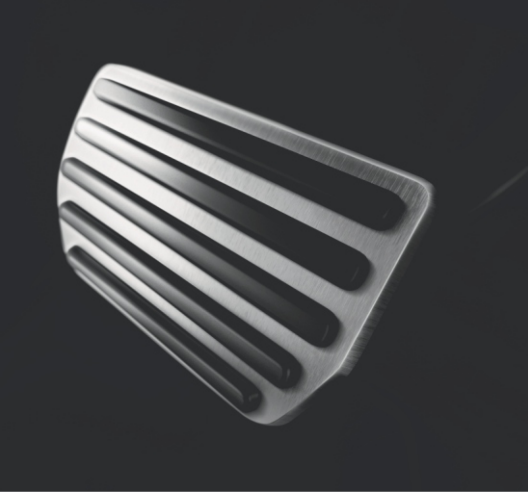

R-DESIGN upholstery

Settle back in unique off black full leather sportsseats.

R-DESIGN décor inlay

The centre stack and door handle inlays convey a sporty, contemporary feel.

Sports gear knob

The illuminated gear knob with perforated leather, gives the gear knob an exciting look and feel.

Sports pedals

Enhance the driving experience with these tough, ridged sports pedals.

Sports steering wheel

Every R-DESIGN model features an exclusive sports steering wheel with embossed logo.

R-DESIGN digital instrument cluster

The R-DESIGN variants get an intuitive digital driver information display with a unique R-DESIGN sporty blue start-up theme.

Sports floor mats

Look down and you will see exclusive sports floor mats that set the stage, front and back.



EXTERIOR DESIGN. V60 Alloy wheels.

DC: Diamond Cut



16" Hera, silver



17" Pallene, silver



17" Rodinia, black, DC



18" Titania, black, DC



18" Skadi, silver bright



18" Modin, iron stone, DC (accessory wheel)



18" Freja, dark grey, DC (accessory wheel)



18" Ixion III, matt black, DC (REDESIGN only)



19" Artio, tech matt grey, DC (accessory wheel)



19" Portia, silver



19" Portia, black, DC



19" Ixion IV, matt black, DC (REDESIGN only)

INTERIOR DETAILS. A selection of premium materials to complement your interior upholstery.



Leather steering wheel, off black



Leather steering wheel, off black with silk metal inlay



Paddle shift steering wheel



Leather gear knob with illumination

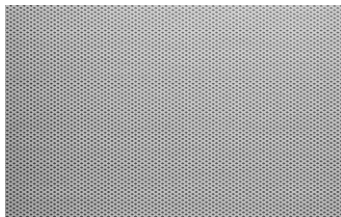

Milled brushed aluminium décor inlay

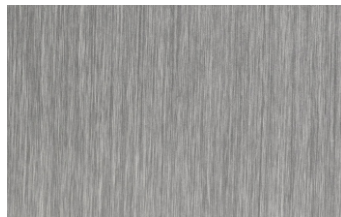

Aluminium décor inlay



Piano black décor inlay



Urbane wood inlay

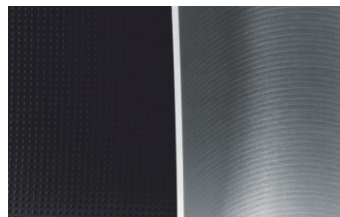

REDESIGN décor inlay





COLOUR YOUR VOLVO. When it comes to the appearance of your Volvo, the choice of exterior colour and wheels are probably your most important design decisions. For more exterior styling options and to build your new Volvo online, please visit www.volvocars.com/za and go to Car Configurator.



019 Black Stone
solid

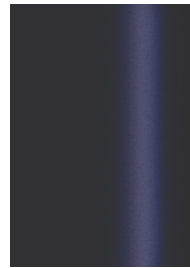

467 Magic Blue
metallic



477 Electric Silver
metallic (i)

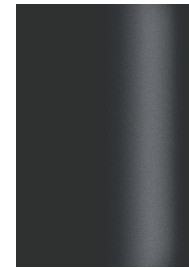

492 Savile Grey
metallic (i)



612 Passion Red
solid (i)



614 Ice White
solid (i)



707 Crystal White
pearl metallic (i)



711 Bright Silver
metallic



714 Osmium Grey
metallic (i)



717 Onyx Black
metallic (i)



719 Luminous Sand
metallic



720 Bursting Blue
metallic (ii)



721 Mussel Blue
metallic

(i) Also available on **REDESIGN** (ii) **REDESIGN** only

Please note: It is not possible to reproduce exact original shades in printed matter. Please ask your dealer to show you samples.

CLEAN COLOURS. To reduce usage of environmentally hazardous solvents all Volvo exterior colours are water-based. What is more, our painting facilities are among the cleanest in the world.

IN FINE DETAIL. The nuts and bolts of your Volvo V60. Whatever you need to know about your new car – be it fuel consumption, CO₂ emissions, top speed or boot space – you will find it here.

ENGINE		T4 Geartronic	T5 Geartronic	D4 Geartronic	D5 Geartronic	T6 Geartronic AWD
Configuration		Transverse – 16 valve	Transverse – 16 valve	Transverse – 16 valve	Transverse – 16 valve	Transverse – 16 valve
Cylinders		4	4	4	4	4
Engine capacity, cc		1969	1969	1969	1969	1969
Bore x stroke, mm		82 x 93.2	82 x 93.2	82 x 93.2	82 x 93.2	82 x 93.2
Max. output ECE,	kW rpm	140 4700	180 5500	140 4250	165 4250	225 5700
Max. torque ECE,	Nm rpm	300 1300-4000	350 1500-4800	400 1750-2500	470 1750-2500	400 2100-4800
Octane rating		95 RON unleaded	95 RON unleaded	50ppm Diesel	50ppm Diesel	95 RON unleaded
Fuel system		Direct fuel injection	Direct fuel injection	Common rail direct injection	Common rail direct injection	Direct fuel injection
Compression ratio		11,3:1	10,8:1	15,8:1	15,8:1	10,3:1

PERFORMANCE		T4 Geartronic	T5 Geartronic	D4 Geartronic	D5 Geartronic	T6 Geartronic AWD
Top speed km/h		225	230	225	230	250
Acceleration 0-100 km/h sec		7.3	6.4	7.7	6.5	6.0
Drag coefficient		0.29	0.29	0.29	0.29	0.29

FUEL CONSUMPTION*		T4 Geartronic	T5 Geartronic	D4 Geartronic	D5 Geartronic	T6 Geartronic AWD
Urban	l/100 km*	7.4	8.6	5.3	5.6	9.1
Extra Urban	l/100 km*	4.9	5.2	3.9	4.4	5.8
Combined	l/100 km*	5.8	6.4	4.4	4.8	7.0
CO ₂ g/km*		136	149	116	125	163
Fuel tank capacity	(litres)	68	68	68	68	68

The results do not express or imply any guarantee of the fuel consumption of a particular car as there are inevitable differences between individual cars of the same model. Additionally, driving style, traffic conditions, as well as the age and mileage and standard of maintenance will affect a car's fuel consumption.

- * All fuel consumption figures and CO₂ emissions are based on the New European Driving Cycle (NEDC) test procedure. This test procedure is designed to assess the emission levels of car engines and fuel economy in passenger cars.
- * The results do not express or imply any guarantee of the fuel consumption of a particular car as there are inevitable differences between individual cars of the same model. Additionally, driving style, traffic conditions, as well as the age and mileage and standard of maintenance will affect a car's fuel consumption.
- * The weight of the vehicle will influence the level of CO₂ emitted. As a result, vehicles with higher levels of specification and factory fit options may emit higher levels of CO₂.

POWER STEERING SYSTEM Turning circle, m (rack and pinion)	ALL MODELS
T4, T5, D4	11.3
D5, T6	11.9

LUGGAGE COMPARTMENT Volume measured in litres	ALL MODELS
Rear seats up, luggage area	430

TRANSMISSION	ALL MODELS
Geartronic (T4)	6 speed
Geartronic FWD (D4, D5, T5)	8 speed
Geartronic AWD (T6)	8 speed

BRAKES	ALL MODELS
Front disc diameter, mm	336 Ventilated
Rear disc diameter, mm	302

GROUND CLEARANCE	ALL MODELS
At kerb weight (mm)	136

WEIGHT	T4 Geartronic	T5 Geartronic	D4 Geartronic	D5 Geartronic	T6 Geartronic AWD
Min. kerb weight, kg (actual kerb weight dependent on spec.)	1582	1596	1597	1619	1699
Max. possible towing weight braked, kg	1600	1800	1800	1800	1800
Max. towing weight unbraked, kg**	750	750	750	750	750
Max. total weight, kg	2200	2200	2200	2200	2270
Max. roof load, kg	75	75	75	75	75

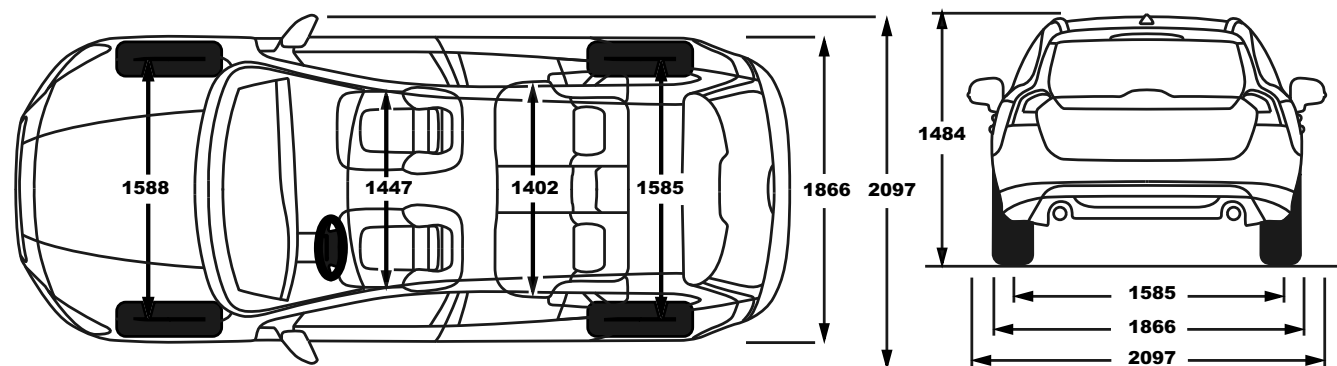
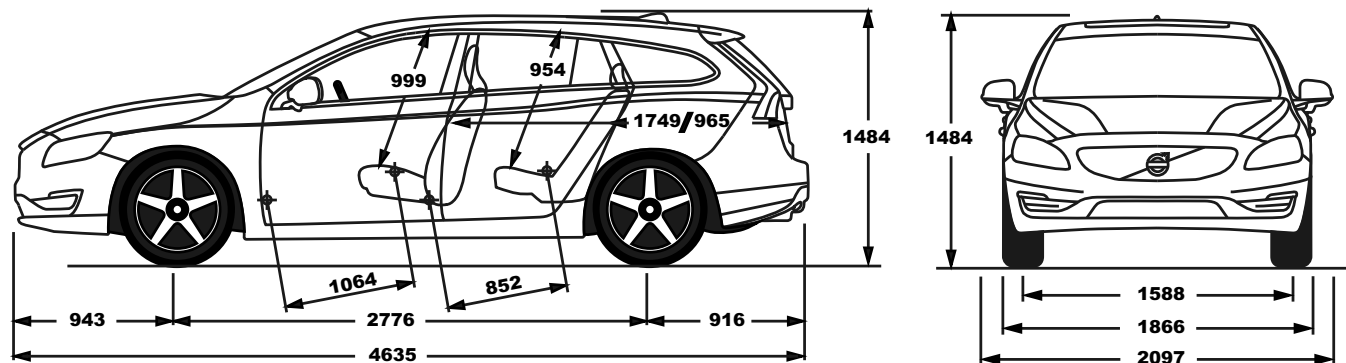

All measurements in mm.

** Unbraked towing weight must not exceed 50% of kerb weight up to a maximum of approximately 750 kg.

NB Some of the information in this brochure may not be correct due to product changes which may have occurred since it was printed. Some of the equipment described or shown may now be available only at extra cost. Before ordering, please ask your Volvo dealer for the latest information. The manufacturer reserves the right to make changes at any time, without notice, to colour, materials, specifications and models.





Volvo Car
Financial Services
A product of WesBank



Volvo Car
Financial Services
A product of WesBank

Volvo Car Road Side Assistance

On 1 January 2014, Tracker Connect became Volvo's new roadside assistance partner.

Services include:

- Medical emergency assistance
- Fuel assistance
- Recovery towing
- Emergency transportation
- "Stand by you" roadside security
- Free mobile app
- Web access to conveniently position your vehicle or draw reports which can be used to log and submit business or private usage to SARS.
- Volvo Car South Africa branded smartphone app
- Flat tyre assistance
- Battery service
- Overnight accommodation
- Accident towing
- Repatriation
- In-car Volvo Assist button
- Impact detection
- Mileage monitoring

Furthermore, the option to include Proactive Stolen Vehicle Recovery for as little as R199* per month is also available.

* Reviewed and adjusted annually.

The number to call is 0800 MYVOLVO (698 6586)

Volvo Car Financial Services

Volvo Car Financial Services has flexible financing options that enable you to structure your deal according to your specific requirements.

We want your experience of buying and owning a Volvo to be enjoyable and hassle-free. That is why we have developed the following online service tools:

- Online finance application – apply for finance any time of day or night and get an instant answer.
- Calculators – calculate your monthly repayments or calculate the value of a vehicle that you could buy based on a specified monthly repayment.
- Account services – manage your account in a secure and user-friendly online environment in real time.

So, remember to insist on Volvo Car Financial Services at your dealer or simply visit www.volvocars.com/za for more information.

Volvo Versatility Finance

For a tailor-made deal and guaranteed future value.

With best-in-class guaranteed future value across the entire Volvo range, it is a forward-thinking way to finance and future-proof your dream Volvo. When you reach the end of your finance period, you can renew, return or retain your Volvo. It is all up to you.

Flexibility today. Certainty tomorrow.

* Terms and conditions apply. As at time of print.



Volvo Car
Insurance

Volvo Car Insurance

Peace of mind. Our idea of luxury.

A Volvo-personalised insurance scheme. Highly competitive comprehensive insurance premiums available on all Volvo models.

Ask your Volvo dealer for more information.

Underwritten by Guardrisk Insurance Company (PTY) LTD, FSP NO:75. Administered by Insurance Underwriting Managers (PTY) LTD, FSP NO:21820.

* Terms and conditions apply.

V O L V O

All models standard with a 5 year / 100 000km Volvo Plan.

NB Some of the information in this brochure may not be correct due to product changes which may have occurred since it was printed. Before ordering, please ask your Volvo dealer for the latest information. The manufacturer reserves the right to make changes at any time, without notice, to colour, materials, specifications and models. Issued June 2017.

VOLVOCARS.COM/ZA