

Profiles 40

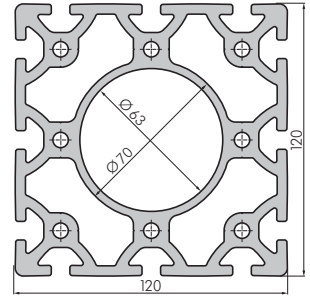

Technical Data	80 x 160 round	80 x 160 round NV	80 x 200	120 x 120
I _x [cm ⁴]	1,354.32	1,300.36	2,120.64	763.23
I _y [cm ⁴]	371.87	364.04	425.40	763.23
W _x [cm ³]	169.29	162.55	212.06	127.21
W _y [cm ³]	92.97	91.01	106.35	127.21
A [cm ²]	59.48	56.65	54.54	47.92
G [kg/m]	16.12	15.35	14.78	12.99
part number	SP8200N	SP8250N	SP8600N	SP7650N
per m charge	SP8201N	SP8251N	SP8601N	SP7651N
cutting charge	SB1003	SB1003	SB1003	SB1003

Profiles 40

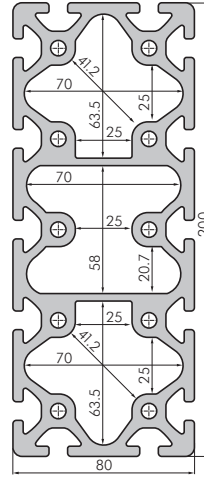
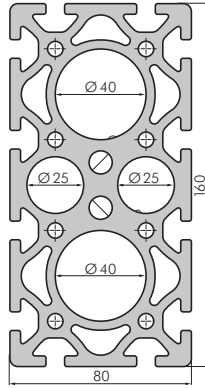
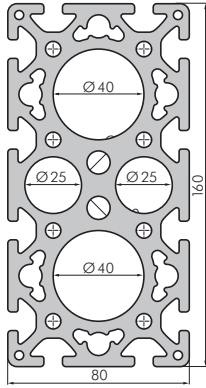
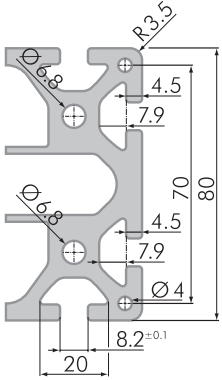
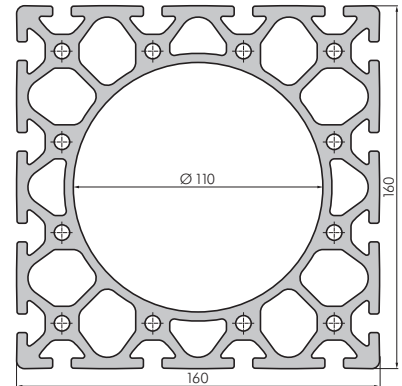
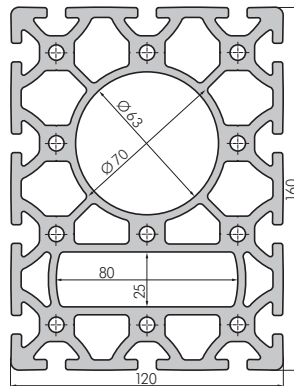
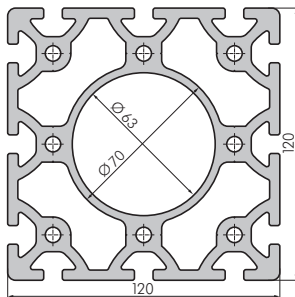

Technical Data	120 x 120 NV	120 x 160	160 x 160
I _x [cm ⁴]	772.13	1,737.86	2,230.55
I _y [cm ⁴]	772.13	1,042.18	2,230.55
W _x [cm ³]	128.69	212.97	278.82
W _y [cm ³]	128.69	173.70	278.82
A [cm ²]	48.31	66.39	74.12
G [kg/m]	13.09	17.99	20.09
part number	SP7660N	SP7670N	SP7680N
per m charge	SP7661N	SP7671N	SP7681N
cutting charge	SB1003	SB1003	SB1003