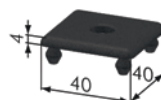
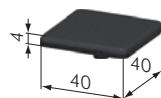
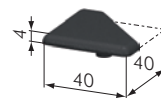
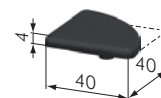
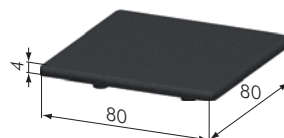
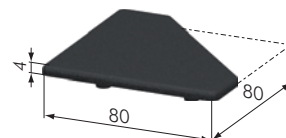
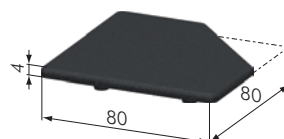
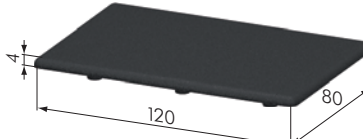
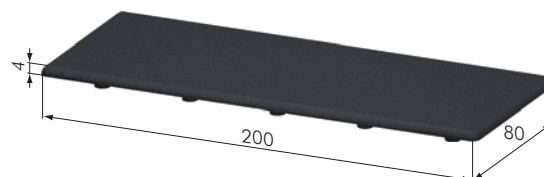

Profile Caps 40

Part №	Part №	Description	Weight
black:	grey:		
SZ0030S	SZ0030G	Profile Cap 16 x 40	2 g
SZ0031S	-	Profile Cap 16 x 80	5 g
SZ0018S	-	Profile Cap 20 x 120	9 g
SZ0019S	-	Profile Cap 20 x 240	18 g
SZ0042S	-	Profile Cap 28 x 120	12 g
SZ0043S	-	Profile Cap 28 x 160	17 g
SZ0010S	SZ0010G	Profile Cap 40 x 40	5 g
SZ0016S	-	Profile Cap 40 x 40 45°	4 g
SZ0017S	-	Profile Cap 40 x 40 R 90	3 g
SZ0011S	SZ0011G	Profile Cap 40 x 80	8 g
SZ0012S	-	Profile Cap 40 x 120	13 g
SZ0013S	-	Profile Cap 40 x 160	21 g
SZ0014S	-	Profile Cap 40 x 200	33 g
SZ0020S	SZ0020G	Profile Cap 80 x 80	17 g
SZ0023S	-	Profile Cap 80 x 80 45°	15 g
SZ0025S	-	Profile Cap 80 x 120	21 g
SZ0021S	-	Profile Cap 80 x 160	34 g
SZ0022S	-	Profile Cap 80 x 200	44 g
SZ0024S	-	Profile Cap 80 x 80 7N 45°	13 g
SZ0100S	-	Profile Cap 120 x 120	29 g
SZ0026S	SZ0026G	Profile Cap R 40 / 80 30°	4 g
SZ0027S	SZ0027G	Profile Cap R 40 / 80 45°	6 g
SZ0028S	SZ0028G	Profile Cap R 40 / 80 60°	7 g
SZ0029S	SZ0029G	Profile Cap R 40 / 80 90°	11 g
SZ0060S	-	Handrail Profile Cap	6 g
SZ0040S	SZ0040G	Profile Cap 40 x 40 D10	5 g

40

SZ0040S

SZ0010S

SZ0016S

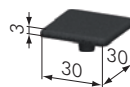
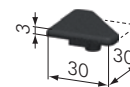
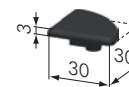
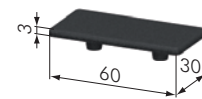
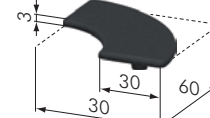
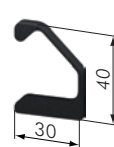
SZ0017S

SZ0020S

SZ0023S

SZ0024S

SZ0025S

SZ0022S

Application: Profile Caps for the profile ranges 40 **standard, semi, double bridge, light and superlight.**

Profile Caps 30

Part №	Description	Weight
SZ0090S	Profile Cap 30 x 30 midi	2.3 g
SZ0096S	Profile Cap 30 x 30 45° midi	1.8 g
SZ0097S	Profile Cap 30 x 30 R 90 midi	2.0 g
SZ0093S	Profile Cap 30 x 60 midi	5.5 g
SZ0091S	Profile Cap R 30 / 60 30° midi	2.3 g
SZ0092S	Profile Cap R 30 / 60 45° midi	2.5 g
SZ0094S	Profile Cap R 30 / 60 60° midi	2.8 g
SZ0095S	Profile Cap R 30 / 60 90° midi	3.4 g
SZ0059S	Profile Cap Set for handle strip profile 30 x 40	5 g
SZ0089S	Profile Cap 13 x 30 midi	16 g

30

SZ0090S

SZ0096S

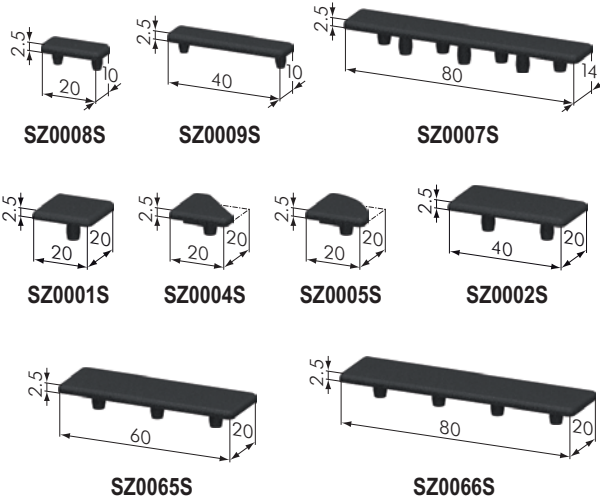
SZ0097S

SZ0093S

SZ0095S

SZ0059S

Application: Profile Caps for the profile range 30.

20



Profile Caps 20		
Part No	Description	Weight
SZ0008S	Profile Cap 10 x 20 mini	0.6 g
SZ0009S	Profile Cap 10 x 40 mini	1.1 g
SZ0007S	Profile Cap 14 x 80 mini	3.3 g
SZ0001S	Profile Cap 20 x 20 mini	1.0 g
SZ0004S	Profile Cap 20 x 20 45° mini	0.7 g
SZ0005S	Profile Cap 20 x 20 R 90 mini	0.8 g
SZ0002S	Profile Cap 20 x 40 mini	1.5 g
SZ0065S	Profile Cap 20 x 60 mini	2.0 g
SZ0066S	Profile Cap 20 x 80 mini	2.5 g
SZ0006S	Profile Cap 20 x 200 mini	7.0 g
SZ0003S	Profile Cap 40 x 40 mini	3.5 g

Application: End caps for the profile range 30.

40

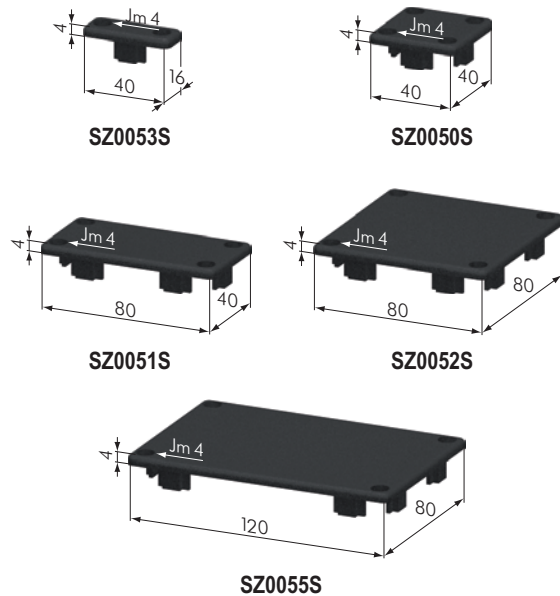

Wiring Duct Caps		
Part No	Description	Weight
SZ0047S	Wiring Duct Cap 30 x 30	
SZ0048S	Wiring Duct Cap 30 x 60	
SZ0049S	Wiring Duct Cap 60 x 60	
SZ0053S	Wiring Duct Cap 16 x 40	3 g
SZ0050S	Wiring Duct Cap 40 x 40	8 g
SZ0051S	Wiring Duct Cap 40 x 80	14 g
SZ0052S	Wiring Duct Cap 80 x 80	30 g
SZ0055S	Wiring Duct Cap 80 x 120	32 g

Application: End caps for wiring ducts.

Supply: 2x/4x sheet metal screw ST 4.2x9.5, DIN 7981

40

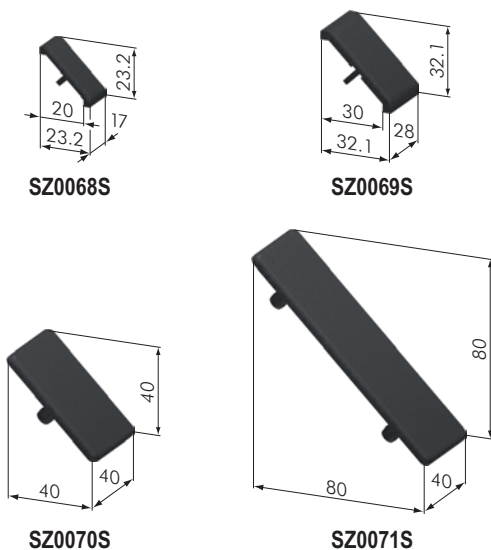

Corner Bracket Caps		
Part No	Description	Weight
SZ0068S	Corner Bracket Cap 20 x 20	2 g
SZ0069S	Corner Bracket Cap 30 x 30	4 g
SZ0070S	Corner Bracket Cap 40 x 40	8 g
SZ0071S	Corner Bracket Cap 40 x 80	15 g

Application: Caps for corner brackets Zn. The corner brackets Zn are also available in a set with the required caps.

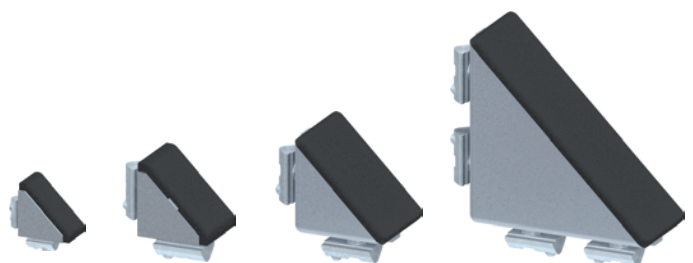

Protection Wall Support Leg Cap

Part No	Description	Weight
SZ0082S	Protection Wall Support Leg Cap 60 x 80	15 g

Application: End caps for protection wall support leg profiles 60 x 80 and 60 x 80 5N.

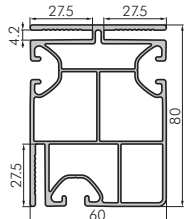

SP6370N
60 x 80

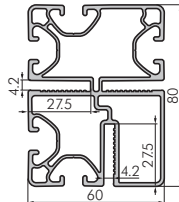

SP6450N
60 x 80 5N

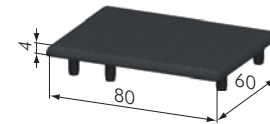
40

SZ0082S

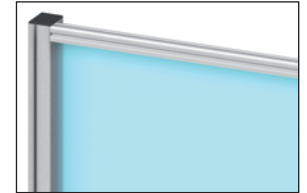
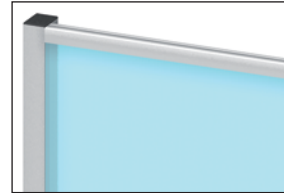

Fixing Angle Caps

Part No	Description	Weight
SZ0075S	Fixing Angle Cap 40 x 40 45°	8 g
SZ0076S	Fixing Angle Cap 40 x 40 round	8 g
SZ0077S	Fixing Angle Cap 40 x 40 edge	16 g

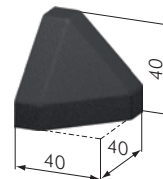
Application: Caps for fixing angles 40 x 40 45°. The fixing angles are also available in a set with the required caps.

40

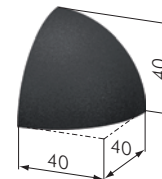
SZ0075S



SZ0076S

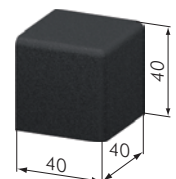

SZ0077S

Inch Profile Caps (only in USA)

Part No	Description	Weight
SZ0110S	Profile Cap 1.0" x 1.0"	1 g
SZ0112S	Profile Cap 1.5" x 1.5"	5 g
SZ0113S	Profile Cap 1.5" x 3.0"	8 g
SZ0114S	Profile Cap 3.0" x 3.0"	17 g

Application: End Caps for inch profiles.

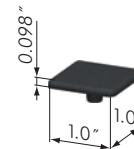
1.5
1.0

SZ0110S

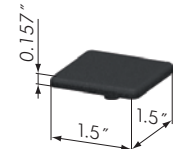

SZ0112S

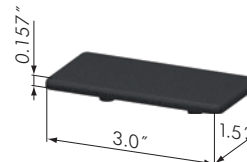

SZ0113S

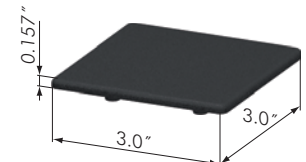

SZ0114S

Profile Cap for SV drillings

Part No	Description	Weight
SZ0099S	Profile Cap for SV drillings	2 g

Application: For covering profile drillings that occur by assembling SV fasteners.

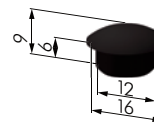
40

SZ0099S

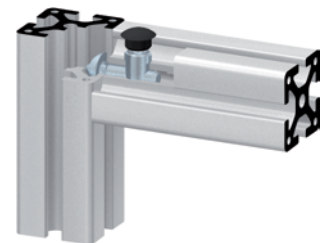
Cap Automatic connector

Part No	Description	Weight
SZ0085S	Cap Automatic connector 40	10 g

Application: For covering profile drillings that occur by assembling SV fasteners.

40

SZ0085S