

PALETTI

Linear C-Track Roller Guides – 10 Lbs. Capacity

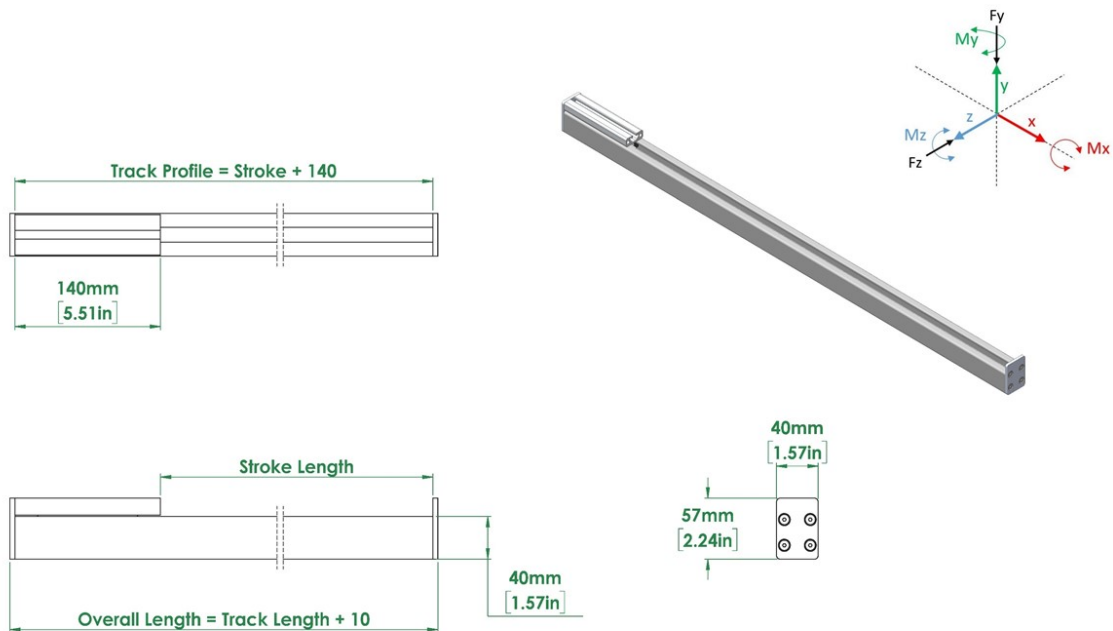

Model	Max Dynamic Load (Lb/N)	Static Axial Load (Fz)(Lb/N)	Static Radial Load (Fy)(Lb/N)	Static Moment Load (Mz)(in-lb/Nm)	Static Moment Load (My)(in-lb/Nm)	Static Moment Load (Mx)(in-lb/Nm)
CGRG10	10 / 45	NA	16 / 35	4 / 35.4	NA	NA
Carriage weight = 0.4 kg						

Please Note - the numbers in these drawings and tables represent performance parameters for our standard model. We can always customize a model more specifically to your application. Due to the construction nature and roller orientation with our C-Track Roller guides, they should be mounted and used only in an upright position.

Paletti linear C-track roller guides are commonly used in classic linear motion applications with a physical load structure supported by 2 or more linear guides and with the load driven with an actuator / screw system / or cylinder. Our C-track roller guides can be an excellent substitute for traditional hardened and ground rail systems which are often over-featured and over-priced for a given application.

Since our C-track roller guides are an exact dimensional and performance match to our C-track belt actuators, the user can greatly simplify their design and installation when using the two together. Also, our C-track roller guides are especially well suited for rolling door and window applications.

Consider these product advantages with Paletti linear slider guides:

- ◆ Special POM roller carriage construction
- ◆ Rollers inside the carriage are internally tensioned
- ◆ Carriage and rail systems do not require lubrication
- ◆ Single axis through multi-axis configurations
- ◆ Single piece carriage and rail construction for all guide types, with corrosion resistant components
- ◆ Carriages and/or slide rails available in special long (20+ feet) lengths

Since our linear actuators and guides, aluminum framing, and conveyors all use the same 8mm T-Slot, it is very easy for us to configure and/or build an entire system or machine base.

We believe in being accessible, so contact us today to learn more!