

PALETTI

Linear Roller Slide Guides – 350 Lbs. Capacity

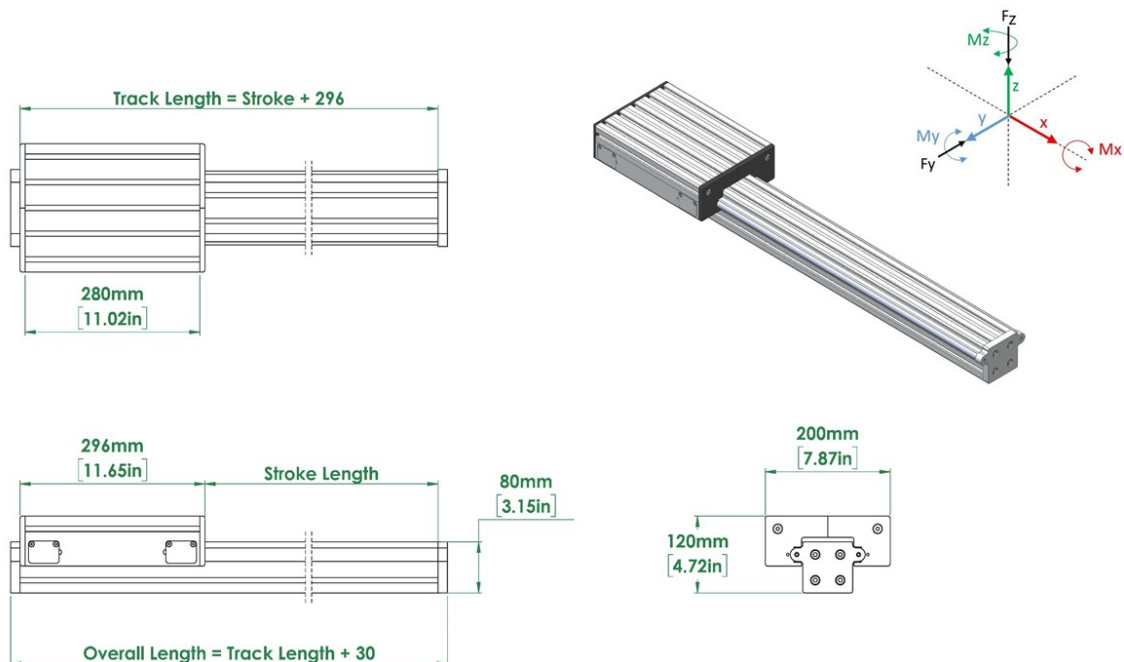

Model	Max Dynamic Load (Lb/N)	Static Axial Load (Fz)(Lb/N)	Static Radial Load (Fy)(Lb/N)	Static Moment Load (Mz)(in-lb/Nm)	Static Moment Load (My)(in-lb/Nm)	Static Moment Load (Mx)(in-lb/Nm)
LGRG350	350 / 1555	450 / 2000	875 / 3900	3761 / 425	1947 / 220	885 / 100
Carriage weight = 7.1 kg						

Please Note - the numbers in these drawings and tables represent performance parameters for our standard model. We can always customize a model more specifically to your application. Please also note the directional coordinate in the above images upper right corner, and plan the orientation of our roller guides accordingly with the performance table above.

Paletti linear roller-slide guides are commonly used in classic linear motion applications with a physical load structure supported by 2 or more linear guides and with the load driven with an actuator / screw system / or cylinder. Our roller-slide guides can be an excellent substitute for traditional hardened and ground rail systems which are often over-featured and over-priced for a given application.

Since our roller-slide guides are an exact dimensional and performance match to our belt actuators, the user can greatly simplify their design and installation when using the two together.

Consider these product advantages with Paletti linear slider guides:

- ◆ Hardened and ground rail and carriage rollers
- ◆ Carriage ends have covers with lubrication ports and internal wiper brushes
- ◆ Single axis through multi-axis configurations
- ◆ Single piece carriage and rail construction for all guide types
- ◆ Carriages and/or slide rails available in special long (20+ feet) lengths
- ◆ Corrosion resistant component options

Since our linear actuators and guides, aluminum framing, and conveyors all use the same 8mm T-Slot, it is very easy for us to configure and/or build an entire system or machine base.

We believe in being accessible, so contact us today to learn more!