

# PALETTI

## Linear Slider Guides – 40 Lbs. Capacity

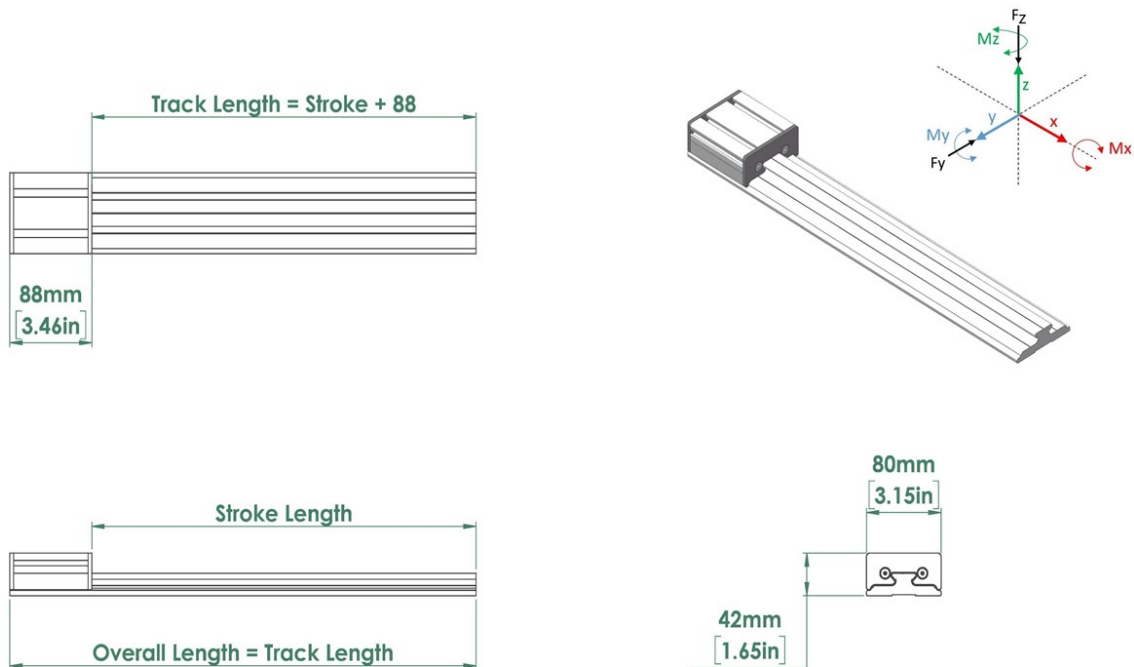

Model	Max Dynamic Load (Lb/N)	Static Axial Load (Fz)(Lb/N)	Static Radial Load (Fy)(Lb/N)	Static Moment Load (Mz)(in-lb/Nm)	Static Moment Load (My)(in-lb/Nm)	Static Moment Load (Mx)(in-lb/Nm)
LGSG40	40 / 178	40 / 178	40 / 178	NA	NA	NA
Carriage weight = 0.4 kg						

Please Note - the numbers in these drawings and tables represent performance parameters for our standard model. We can always customize a model more specifically to your application. Since our linear slider guide carriages completely surround the rail, they can be mounted and used at any angle, and as such, there is no moment loading.

Paletti linear slider guides are commonly used in classic linear motion applications with a physical load structure supported by 2 or more linear guides and with the load driven with an actuator / screw system / or cylinder. Our slider guides can be an excellent substitute for traditional hardened and ground rail systems which are often over-featured and over-priced for a given application.

Consider these product advantages with Paletti linear slider guides:

- ◆ Vertically compact and ideal for restricted spaces
- ◆ Can be mounted and used in any angle
- ◆ Design features polymeric shaft bearings through 4 guidance bores
- ◆ Single axis through multi-axis configurations
- ◆ Single piece carriage and rail construction for all guide types
- ◆ Carriages and/or slide rails available in special long (20+ feet) lengths
- ◆ Corrosion resistant component options

Since our linear actuators and guides, aluminum framing, and conveyors all use the same 8mm T-Slot, it is very easy for us to configure and/or build an entire system or machine base.

**We believe in being accessible, so contact us today to learn more!**