

PALETTI

Linear Slide Actuators – Belt Driven – 350 Lbs. Upright Carriage Configuration

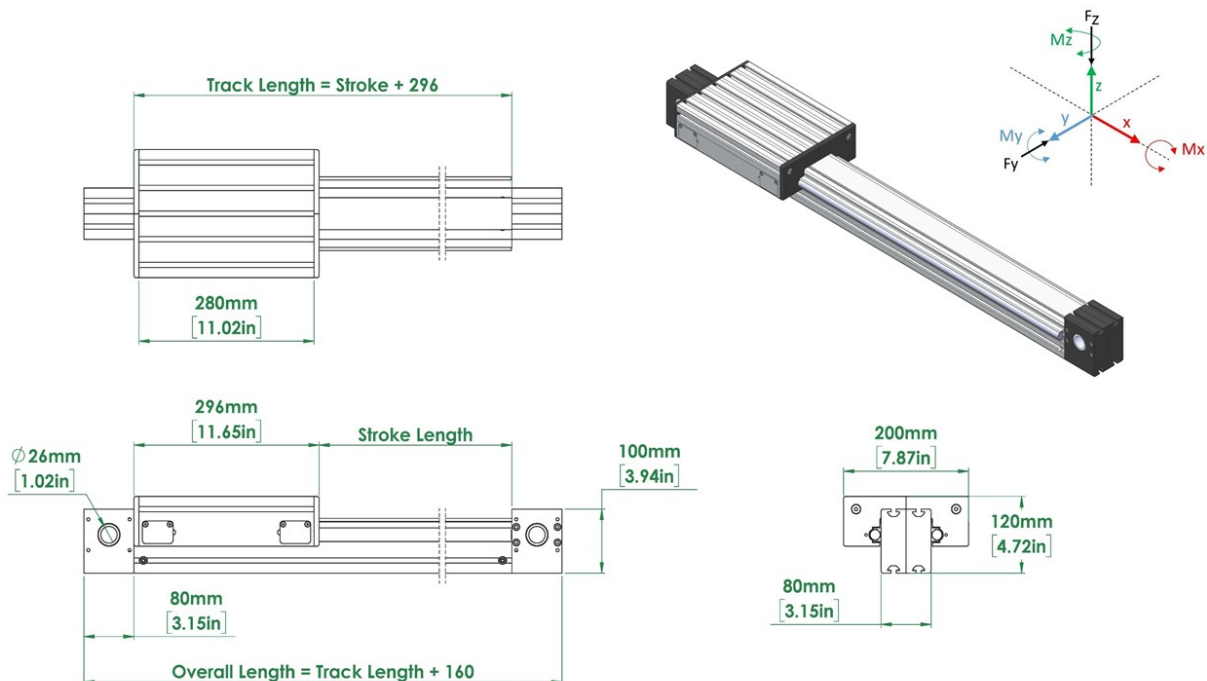

Model	Max Dynamic Load (Lb/N)	Static Axial Load (Fz)(Lb/N)	Static Radial Load (Fy)(Lb/N)	Static Moment Load (Mz)(in-lb/Nm)	Static Moment Load (My)(in-lb/Nm)	Static Moment Load (Mx)(in-lb/Nm)
BTRU350	350 / 1555	450 / 2000	875 / 3900	3761 / 425	1947 / 220	885 / 100
	Max Speed	Pulley Pitch Diameter (mm)	Pulley Torque (in-lb/Nm)	Belt Tensile Strength (Lb/N)	Elongation	Carriage Weight (kg)
	8 m/s	47.75	531 / 60	1798 / 8000	.1% @ 2012 N	7.1

Please Note - the numbers in these drawings and tables represent performance parameters for our standard model. We can always customize a model more specifically to your application. Actual performance will vary pending motor/gearing selection.

When high speeds and long travel distances (20+feet) are required, Paletti toothed belt driven linear roller-slide actuator systems are ideally suited for your material handling and positioning tasks. Toothed belt driven linear systems are easy to incorporate into single or multi axis applications and offer long service life with minimal noise and maintenance. Matching linear guide available.

The Upright carriage configuration is more commonly used than our other configurations. Some of these capacity models can be mounted and operated at any angle due to their unique guided design.

Some additional product advantages with Paletti belt driven slide actuators:

- ◆ AT10 tooth profile belts with easy tensioning and zero backlash
- ◆ Multiple belt material options – pending application needs
- ◆ End of carriage covers with lubrication ports and brushes to help keep the rails clean
- ◆ Easy to perform maintenance – without removal from the machine
- ◆ Single piece carriage and rail construction, with corrosion resistant component options

Since our actuators, aluminum framing, and conveyors all use the same 8mm T-Slot, it is very easy for us to configure and/or build an entire system or machine base.

We believe in being accessible, so contact us today to learn more!