

ACME

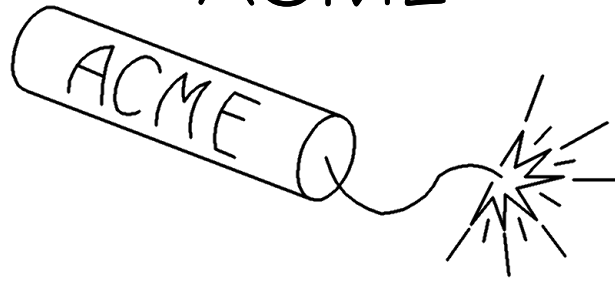

700 Worktop Routing Jig

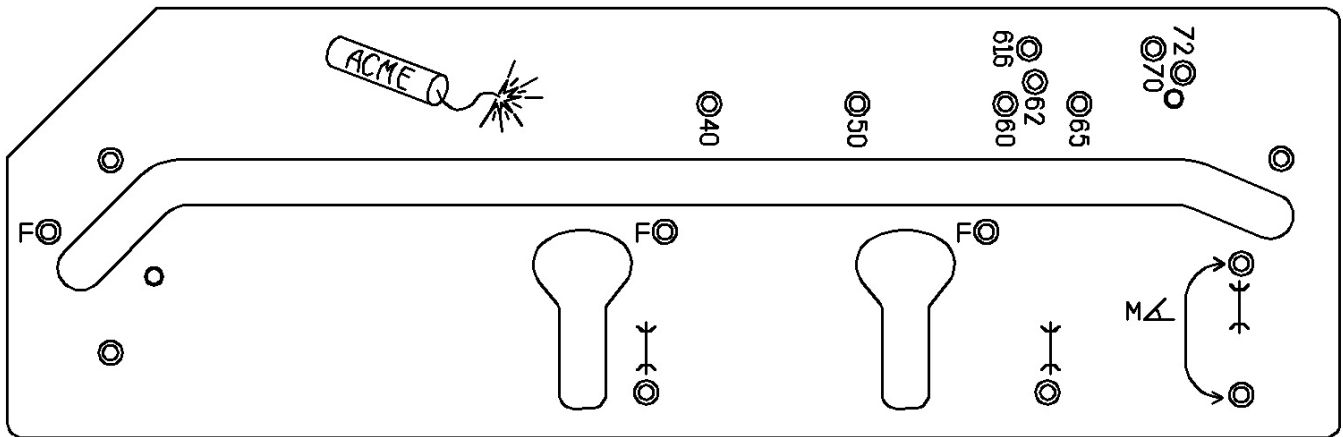

WORKTOP JIG 700

- ❖ CUT RIGHT AND LEFT STANDARD 90° AND 45° JOINTS
- ❖ CUT RECESSES FOR WORKTOP CONNECTING BOLTS
- ❖ CUTS WORKTOPS FROM 400mm TO 720mm WIDE
- ❖ EASY TO FOLLOW SYMBOLS

ADDITIONAL EQUIPMENT REQUIRED:

- HAND ROUTER
- Ø30mm ROUTER GUIDE BUSH
- TUNGSTEN CARBIDE ROUTER CUTTER - Ø12.7mm X 50mm (Ø1/2 " X 2 ")
- MINIMUM OF 2 QUICK ACTION OR 'G' CLAMPS

Safety Notes

Before starting

- ◆ Never cut worktop to length until all joints are complete and have been checked for correct fit.
- ◆ Make sure the worktop is secured firmly to the bench or trestle.
- ◆ Ensure that the jig is firmly secured to the worktop.
- ◆ Ensure there are no obstructions in the path of the router e.g. clamps or bench.
- ◆ Always use good quality sharp router bits
- ◆ Always wear eye protection when cutting.
- ◆ Always wear ear protection if cutting for long periods
- ◆ Always cut from left to right.
- ◆ Always cut into post formed edge to avoid breakout or chipping.
- ◆ Always keep the router vertical to the jig and worktop.
- ◆ Never exceed 10mm depth of cut in one pass.
- ◆ Never remove the router from the jig or position the router whilst cutter is still rotating. The cutter may cut into the jig and damage the bush location faces.

This jig will enable you to cut

STANDARD LEFT & RIGHT HAND 90° JOINTS

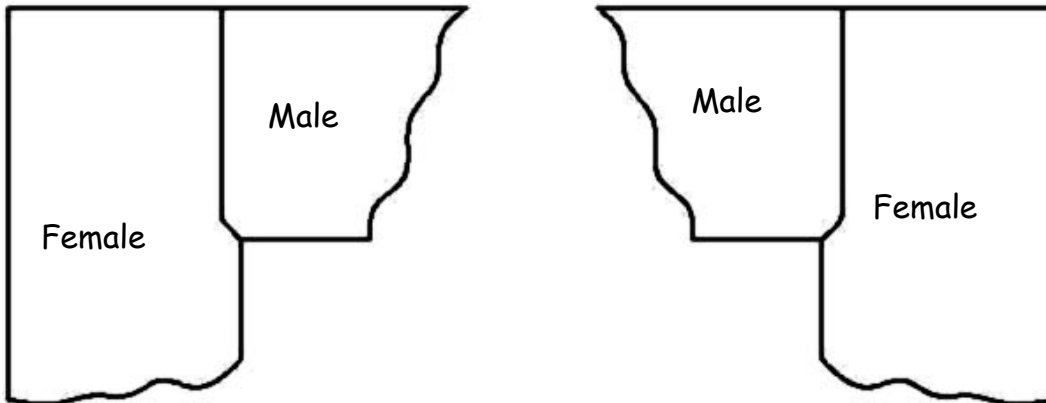

45° JOINTS -
RIGHT AND LEFT
HAND

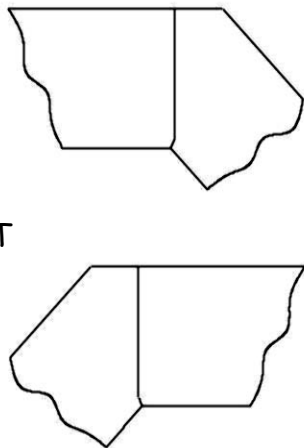

CORNER JOINT -
USING THE RIGHT
HAND AND LEFT
HAND 45° JOINTS

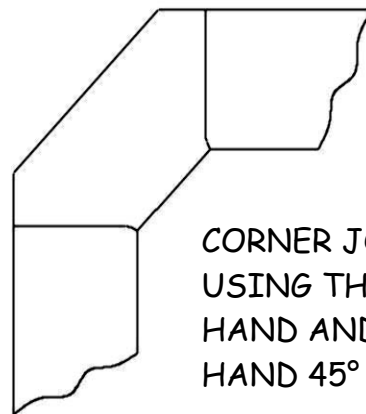

Left Hand 90° Joints

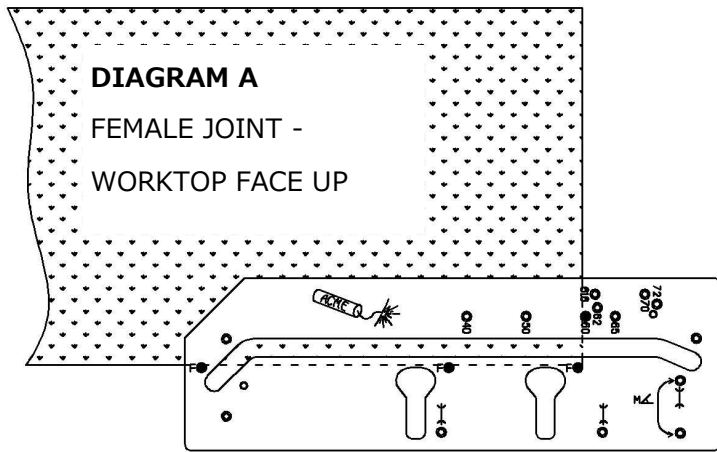

DIAGRAM B

MALE JOINT — WORKTOP FACE DOWN

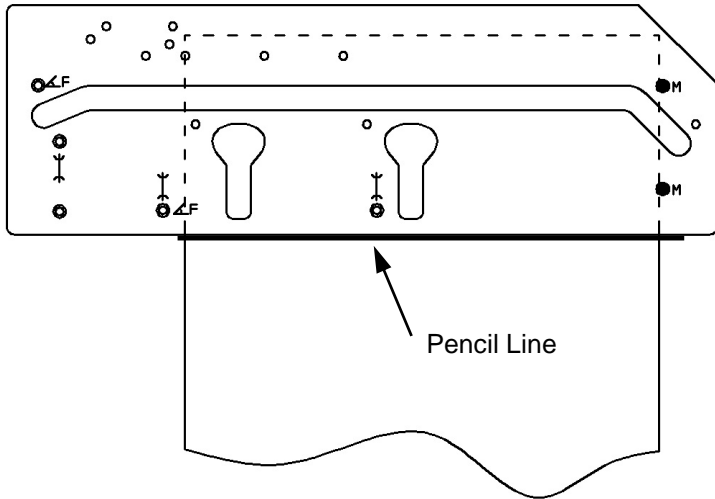

DIAGRAM C

FEMALE BOLT RECESS -
WORKTOP FACE DOWN.

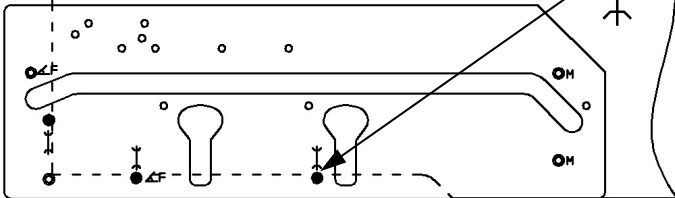
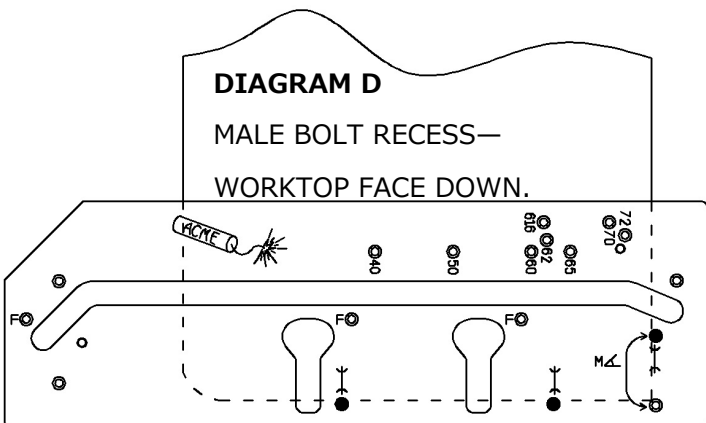

DIAGRAM D

MALE BOLT RECESS—
WORKTOP FACE DOWN.



- FEMALE JOINT** Refer to the diagrams on the different joints available. For the female cut in your worktop, position the jig as shown in diagram A and with the worktop face up and the post formed (curved edge) towards you.
- Insert two or three pins in the holes marked F.
- Insert the 4th pin in the hole dependant on your worktop width. e.g. If your worktop is 600mm wide then insert the 4th pin in the hole marked 600 (see diagram A).
- Make sure the pins in the holes marked with F are firmly pushed against the front post formed edge and the pin in the hole marked with the worktop width is pushed firmly against the edge of the worktop (see diagram A)
- Clamp the jig to the worktop checking that all pins are still against the worktop. Make sure the clamps will not obstruct the router path.
- CUTTING** Position the router in the far left side of the central slot. Set the router to cut a depth of 10mm.
- IMPORTANT** - Position the router in the slot and cut from left to right, pulling the router against the edge of the slot closest to you.
- Remove the router, and start again from the far left of the central slot, but increase the depth a further 10mm.
- Follow steps 6 - 8, until cut is complete.
- For the final finishing cut, position the router again in the far left side of the central slot, and set the router to cut at the full depth of the worktop. Again, cut from left to right but apply the pressure to the edge furthest away from you.
- MALE JOINT** For the male cut in your worktop, prepare the worktop face down and turn the jig over from the face used previously.
- Insert 2 pins in holes marked M.
- Refer to the page on 'cutting to length' on page 6 to find out where to mark the pencil line to determine the position of the jig along the length of the worktop.
- Make sure the 2 pins in the holes marked M are firmly pushed against the post formed edge (see diagram B)
- Clamp the jig to the worktop checking that both pins are still against the worktop. Make sure the clamps will not obstruct the router path.
- Follow steps 6 to 10 for cutting the worktop.
- FEMALE BOLT RECESSES** Take the worktop into which you have cut the female cut and position the worktop face down.
- Position the jig as shown in diagram C, and insert 3 pins in the holes which have a symbol resembling a worktop connector bolt.
- Make sure the 3 pins are firmly pushed against the front cut out and the edge of the worktop.
- Clamp the jig to the worktop checking that all 3 pins are still firmly against the worktop. Make sure the clamps will not obstruct the router path.
- You will need a depth of 20mm for the worktop connectors. Do not exceed 10mm per cut.
- Cut the bolt recesses out, each time clearing the waste material after each cut.
- MALE BOLT RECESSES** Take the worktop into which you have cut the male cut and position the worktop face down.
- Position the jig as shown in diagram D and insert 3 pins in the holes which have a symbol resembling a worktop connector bolt.
- Make sure the 3 pins are firmly pushed against the front cut out and the edge of the worktop.
- Clamp the jig to the worktop checking that all 3 pins are still firmly against the worktop. Make sure the clamps will not obstruct the router path.
- You will need a depth of 20mm for the worktop connectors. Do not exceed 10mm per cut.
- Cut the bolt recesses out, each time clearing the waste material after each cut.

Right Hand 90° Joints

DIAGRAM A

FEMALE JOINT—WORKTOP
FACE DOWN

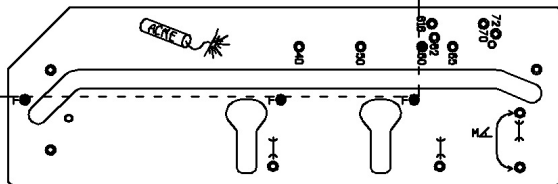

DIAGRAM B

MALE JOINT—
WORKTOP FACE UP

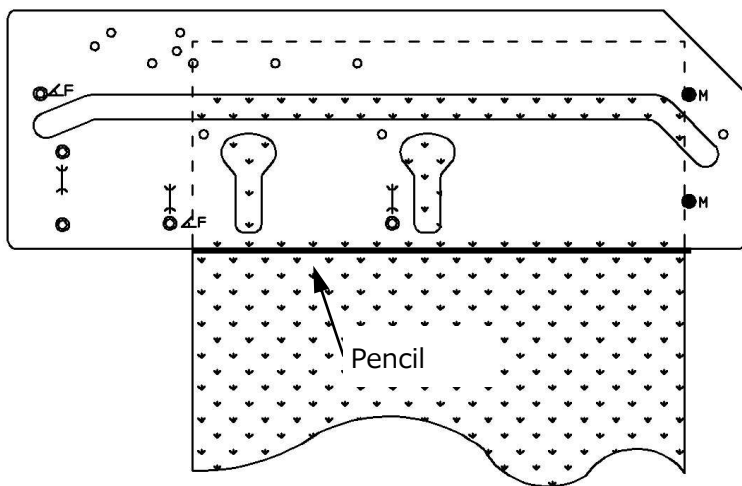

DIAGRAM C

FEMALE BOLT RECESS -
WORKTOP FACE DOWN.

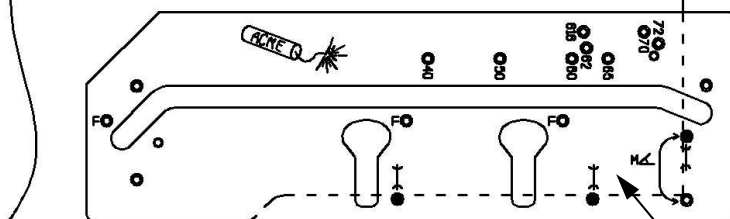
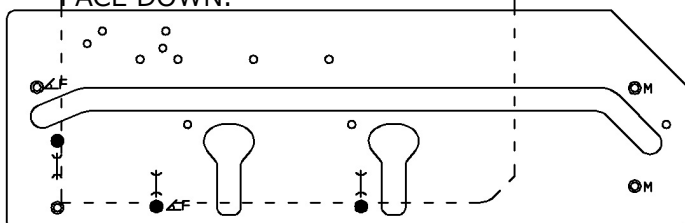

DIAGRAM D

MALE BOLT RECESS —WORKTOP
FACE DOWN.



- FEMALE JOINT** For the female cut in your worktop, position the jig as shown in diagram A and the worktop face down and the post formed (curved edge) towards you.
- Insert two or three pins in the holes marked F.
- Insert the 4th pin in the hole dependant on your worktop width, e.g. If your worktop is 600mm wide then insert the 4th pin in the hole marked 600 (see diagram A).
- Make sure the pins in the holes marked F are firmly pushed against the front post formed edge and the pin in the hole marked with the worktop width is pushed firmly against the edge of the worktop (see diagram A)
- Clamp the jig to the worktop double-checking that all pins are still against the worktop. Make sure the clamps will not obstruct the router path.
- CUTTING** Position the router in the far left side of the central slot. Set the router to cut a depth of 10mm.
- IMPORTANT** - Position the router in the slot and cut from left to right, pulling the router against the edge of the slot closest to you.
- Remove the router, and start again from the far left of the central slot, but increase the depth a further 10mm.
- Follow steps 6 - 8, until cut is complete.
- For the final finishing cut, position the router again in the far left side of the central slot, and set the router to cut at the full depth of the worktop. Again, cut from left to right but apply the pressure to the edge furthest away from you.
- MALE JOINT** For the male cut in your worktop, prepare the worktop face up and turn the jig over from the face used previously.
- Insert 2 pins in holes marked M.
- Refer to the page on 'cutting to length' on page 6 to find out where to mark the pencil line to determine the position of the jig along the length of the worktop.
- Make sure the 2 pins in the holes marked M are firmly pushed against the post formed edge (see diagram B)
- Clamp the jig to the worktop checking that both pins are still against the worktop. Make sure the clamps will not obstruct the router path.
- Follow steps 6 to 10 for cutting the worktop.
- FEMALE BOLT RECESSES** Take the worktop into which you have cut the female cut and position the worktop face down.
- Position the jig as shown in diagram C, and insert 3 pins in the holes which have a symbol resembling a worktop connector bolt.
- Make sure the 3 pins are firmly pushed against the front cut out and the edge of the worktop (see diagram C).
- Clamp the jig to the worktop checking that all 3 pins are still firmly against the worktop. Make sure the clamps will not obstruct the router path.
- You will need a depth of 20mm for the worktop connectors. Do not exceed 10mm per cut.
- Cut the bolt recesses out, each time clearing the waste material after each cut.
- MALE BOLT RECESSES** Take the worktop into which you have cut the male cut and position the worktop face down.
- Position the jig as shown in diagram D and insert 3 pins in the holes which have a symbol resembling a worktop connector bolt.
- Make sure the 3 pins are firmly pushed against the front cut out and the edge of the worktop (see diagram D).
- Clamp the jig to the worktop checking that all 3 pins are still firmly against the worktop. Make sure the clamps will not obstruct the router path.
- You will need a depth of 20mm for the worktop connectors. Do not exceed 10mm per cut.
- Cut the bolt recesses out, each time clearing the waste material after each cut.

Cutting to Length

When producing a male joint, left or right hand, the position of the worktop jig has to be calculated. It is easier if the female joint is cut first, leaving the gap intended for the male part of the worktop.

Example

The female joint has already been cut (see left diagram) and the length of the male worktop needed is 1000mm (1 metre).

Position your worktop jig onto the worktop referring back to the instructions on 90° joints.

Subtract 166mm from the intended length (this is the distance from the edge of the jig to where the cut will be)

E.g. $1000\text{mm} - 166 = 834\text{mm}$

Position the worktop jig 834mm from the opposite end of the worktop you're cutting (see bottom left diagram)

After the cut, a 1000mm length worktop is left.

Change the 1000mm figure used in this example for whatever length you require.

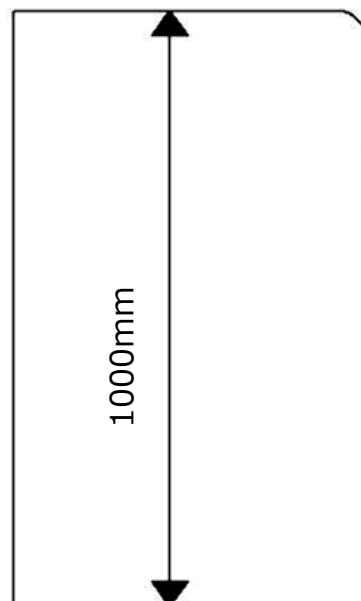
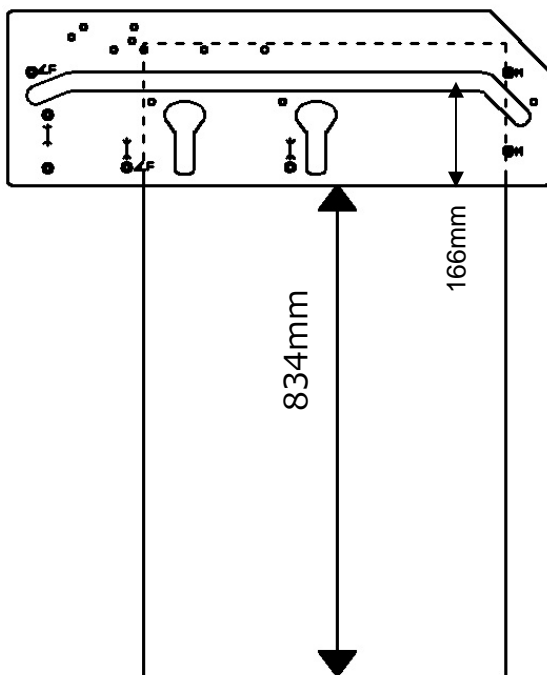
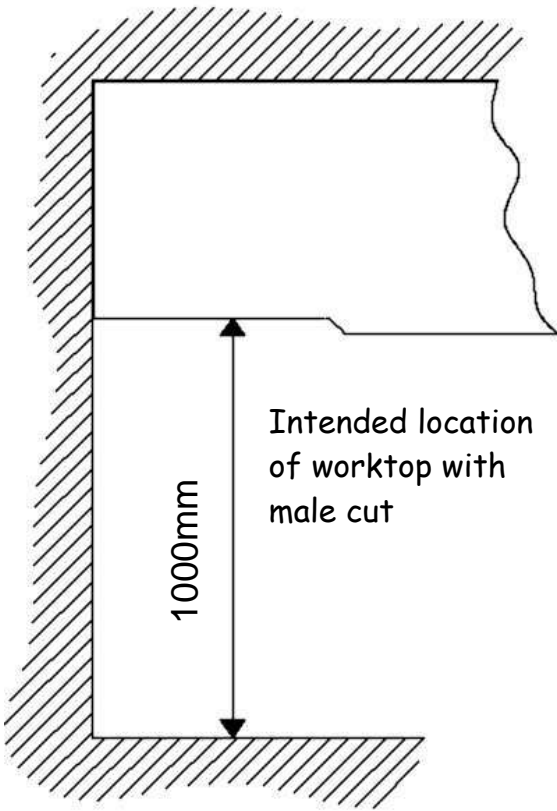

Left Hand 45° Joints

DIAGRAM A
FEMALE JOINT-
WORKTOP FACE UP

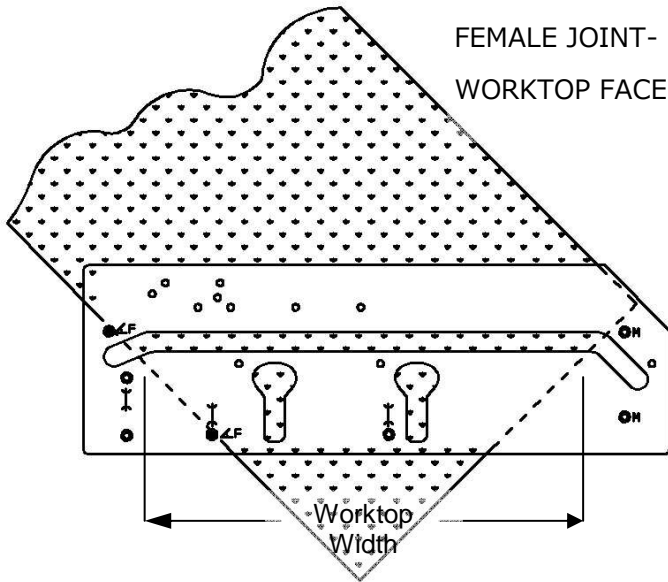

DIAGRAM B
FEMALE JOINT -
TRIM WORKTOP

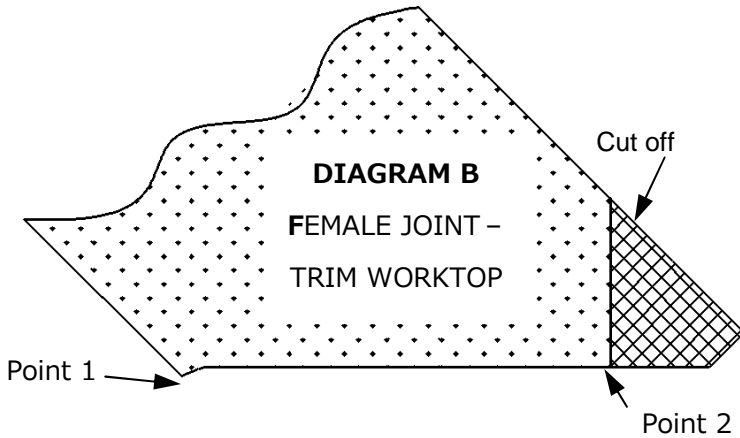

DIAGRAM C
MALE JOINT -
WORKTOP FACE DOWN

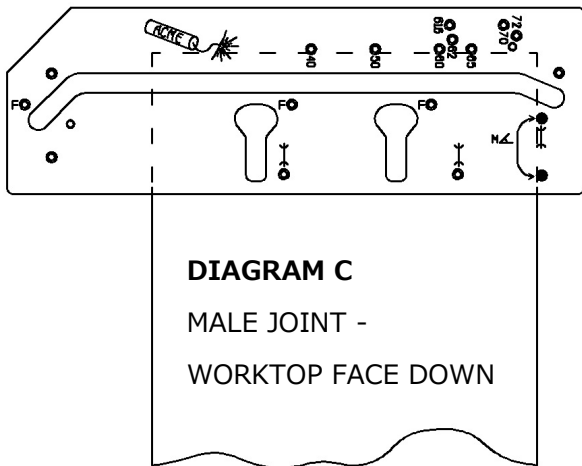
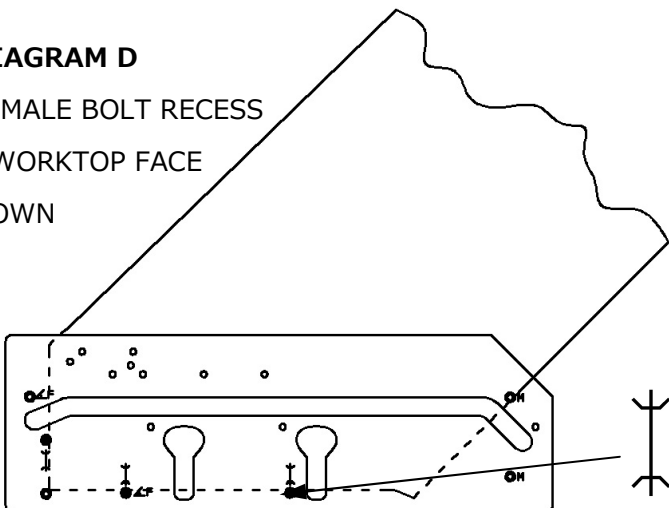
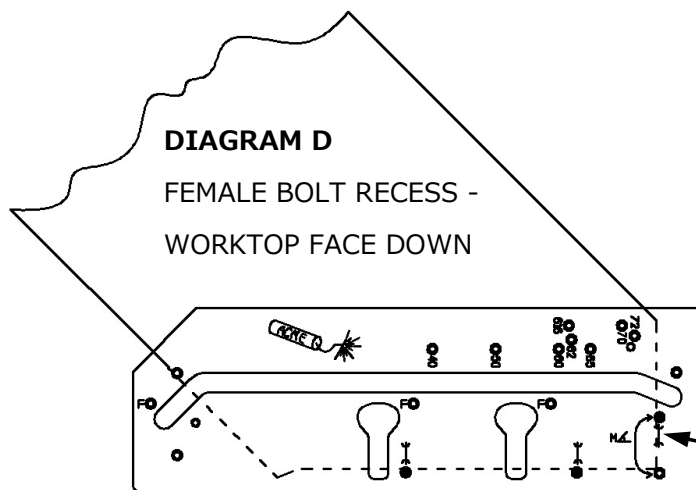
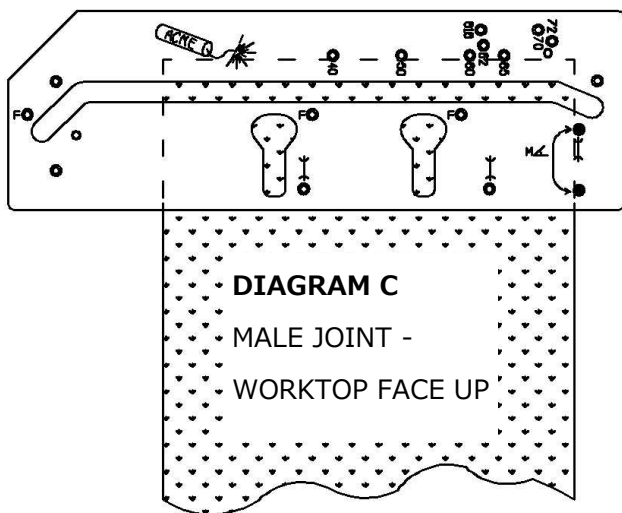
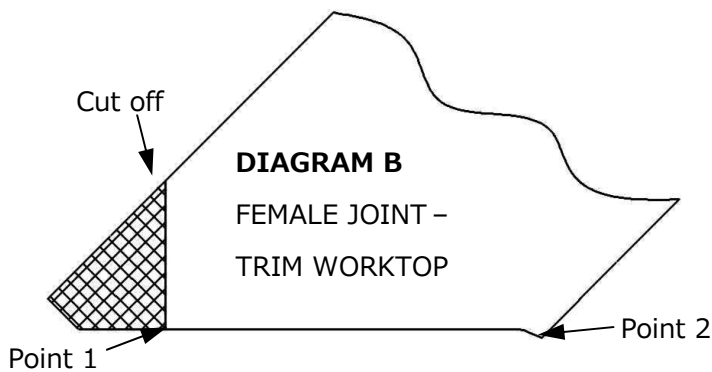
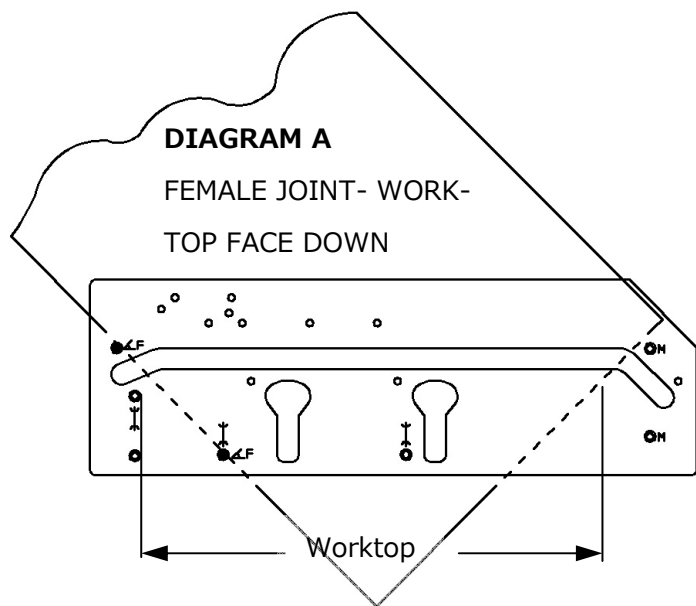

DIAGRAM D
FEMALE BOLT RECESS
- WORKTOP FACE
DOWN



1. **FEMALE JOINT** Refer to the diagrams on the different joints available. For the female cut in your worktop, position the jig as shown in diagram A (logo down) and the worktop face up with the post formed (curved edge) towards you.
2. Insert 2 pins in the holes marked **F**.
3. Slide the jig along the length of the worktop, once the jointing face has been cut, there will be enough length for the male worktop to fit (minor adjustment may be necessary - see diagram B)
4. Make sure the 2 pins in the holes marked **F** are firmly pushed against the front post formed edge (see diagram A)
5. Clamp the jig to the worktop checking that both pins are still against the worktop. Make sure the clamps will not obstruct the router path.
6. Once the cut is complete, cut off the excess (Diagram B), so that the distance from point 1 to point 2 is equal to your worktop width.
7. **CUTTING** Position the router in the far left side of the central slot. Set the router to cut a depth of 10mm.
8. **IMPORTANT** - Position the router in the slot and cut from left to right, pulling the router against the edge of the slot closest to you.
9. Remove the router, and start again from the far left of the central slot, but increase the depth a further 10mm.
10. Follow steps 7 - 9, until cut is complete.
11. For the final finishing cut, position the router again in the far left side of the central slot, and set the router to cut at the full depth of the worktop. Again, cut from left to right but apply the pressure to the edge furthest away from you.
12. **MALE JOINT** For the male cut in your worktop, prepare the worktop face down and turn the jig over from the face used previously.
13. Insert 2 pins in holes marked **M**.
14. Refer to the page on 'cutting to length' on page 6 to find out where to mark the pencil line to determine the position of the jig along the length of the worktop.
15. Make sure the 2 pins in the holes marked **M** are firmly pushed against the post formed edge (see diagram C)
16. Clamp the jig to the worktop checking that both pins are still against the worktop. Make sure the clamps will not obstruct the router path.
17. Follow steps 6 to 10 for cutting the worktop.
18. **FEMALE BOLT RECESSES** Take the worktop into which you have cut the female cut and position the worktop face down.
19. Insert 3 pins in the holes which have a symbol resembling a worktop connector bolt (see diagram D).
20. Make sure the 3 pins are firmly pushed against the front cut out and the edge of the worktop (see diagram D).
21. Clamp the jig to the worktop checking that all 3 pins are still firmly against the worktop. Make sure the clamps will not obstruct the router path.
22. You will need a depth of 20mm for the worktop connectors. Do not exceed 10mm per cut.
22. Cut the bolt recesses out, each time clearing the waste material after each cut.
23. **MALE BOLT RECESSES** Take the worktop into which you have cut the male cut and position the worktop face down.
24. Insert 3 pins in the holes which have a symbol resembling a worktop connector. Follow instructions on male bolt recesses on page 4 referring to left hand 90 degree joints.

Right Hand 45° Joints



1. **FEMALE JOINT** Refer to the diagrams on the different joints available. For the female cut in your worktop, position the jig as shown in diagram A (logo down) and the worktop face down with the post formed (curved edge) towards you.
2. Insert 2 pins in the holes marked **F**.
3. Slide the jig along the length of the worktop, once the jointing face has been cut, there will be enough length for the male worktop to fit (minor adjustment may be necessary) see diagram B)
4. Make sure the 2 pins in the holes marked **F** are firmly pushed against the front post formed edge (see diagram A)
5. Clamp the jig to the worktop checking that both pins are still against the worktop. Make sure the clamps will not obstruct the router path.
6. Once the cut is complete, cut off the excess (Diagram B), so that the distance from point 1 to point 2 is equal to your worktop width.
7. **CUTTING** Position the router in the far left side of the central slot. Set the router to cut a depth of 10mm.
8. **IMPORTANT** - Position the router in the slot and cut from left to right, pulling the router against the edge of the slot closest to you.
9. Remove the router, and start again from the far left of the central slot, but increase the depth a further 10mm.
10. Follow steps 7 - 9, until cut is complete.
11. For the final finishing cut, position the router again in the far left side of the central slot, and set the router to cut at the full depth of the worktop. Again, cut from left to right but apply the pressure to the edge furthest away from you.
12. **MALE JOINT** For the male cut in your worktop, prepare the worktop face up and turn the jig over from the face used previously.
13. Insert 2 pins in holes **M**.
14. Refer to the page on 'cutting to length' on page 6 to find out where to mark the pencil line to determine the position of the jig along the length of the worktop.
15. Make sure the 2 pins in the holes marked **D** are firmly pushed against the post formed edge (see diagram C)
16. Clamp the jig to the worktop checking that both pins are still against the worktop. Make sure the clamps will not obstruct the router path.
17. Follow steps 6 to 10 for cutting the worktop.
18. **FEMALE BOLT RECESSES** Take the worktop into which you have cut the female cut and position the worktop face down.
19. Insert 3 pins in the holes which have a symbol resembling a worktop connector (see diagram D).
20. Make sure the 3 pins are firmly pushed against the front cut out and the edge of the worktop (see diagram D).
21. Clamp the jig to the worktop checking that all 3 pins are still firmly against the worktop. Make sure the clamps will not obstruct the router path.
22. You will need a depth of 20mm for the worktop connectors. Do not exceed 10mm per cut.
23. Cut the bolt recesses out, each time clearing the waste material after each cut.
24. **MALE BOLT RECESSES** Prepare the male worktop with the worktop face down and the jig face up.
25. Insert 3 pins in the holes which have a symbol resembling a worktop connector. Follow instructions on male bolt recesses on page 5 referring to right hand 90 degree joints.