

MOVINORD 82

DESIGN
DYNAMOBEL

dynamobel



M82

M82 is a system of modular, demountable partitioning with visible profiling in galvanised steel. Thanks to its sturdiness and reliability, it is ideal for environments which call for high acoustic and technical performance and which need partitions to behave well in the face of fire.

With a wide range of surface-finish and configuration options, M82 is easy to assemble and reinstall, and is complemented with a wall cover system.

The panels are installed by simply fitting splice profiles, and door and window frames are independent from the internal frame to simplify assembly and dismantling. The system can cater for uneven heights of $\pm 20\text{mm}$.

The acoustic insulation provided by M82 is optimum: 45 dB on blind modules (A) and 44 dB on glazed modules (B2g)- according to CSIS L. Torres Quevedo Spain, EN ISO 140-3 standard.

M82 PARTICIÓN

M82 es un sistema de particiones de perfilera vista en acero galvanizado, desmontable y modular. Gracias a su robustez y fiabilidad, es idóneo para entornos que requieren altas prestaciones técnicas acústicas y de comportamiento frente al fuego.

Con amplias posibilidades de acabados y configuraciones, M82 es fácilmente montable y reinstalable, y se complementa con un sistema de forro de pared.

Los paneles se instalan con la simple colocación del tapajuntas, y los marcos de las puertas y ventanas son independientes de la estructura interna para simplificar el montaje y desmontaje. La tolerancia de absorción en altura es de $\pm 20\text{mm}$.

El aislamiento acústico que proporciona M82 es óptimo 45 dB en módulos ciegos (A) y 44 dB en módulos vidrieros (B2g) según CSIS L. Torres Quevedo España, norma EN ISO 140-3.

TRENNWANDSYSTEM M82

M82 ist ein Trennwandssystem mit sichtbaren Profilen aus galvanisiertem Stahl. Es ist ausbaubar und hat einem modularen Aufbau. Dank seiner Widerstandsfähigkeit und Zuverlässigkeit ist dieses System ideal für Bereiche, in denen hohe Ansprüche an den Schallschutz und an die Brandschutzeigenschaften gestellt werden.

Neben seinen umfangreichen Möglichkeiten in Bezug auf die Gestaltung der Oberflächen und die möglichen Konfigurationen zeichnet sich M82 vor allem durch folgende Eigenschaften aus: Es ist einfach zu montieren und wiederzuverwenden und kann durch ein Wandverkleidungssystem ergänzt werden.

Der Einbau der Paneele erfolgt durch einfaches Anbringen der Fugenleisten, und die Rahmen der Türen und Fenster sind unabhängig von der inneren Struktur, um ihren Ein- und Ausbau zu erleichtern. Ein Höhenausgleich von $\pm 20\text{mm}$ ist möglich.

Das System M82 bietet eine optimale akustische Isolierung: 45 dB bei nicht transparenten Modulen (A) und 44 dB bei Glaselementen (B2g) nach Messungen des Technologieinstituts CSIS L. Torres Quevedo, Spanien, gemäß der Norm EN ISO 140-3.

PARTICIÓN M82

M82 PARTITION
TRENNWANDSYSTEM M82

M82 CRYSTAL

M82 CRYSTAL
M82 CRYSTAL

FORRO DE PARED D82

D82 WALL COVER
WANDVERKLEIDUNG D82

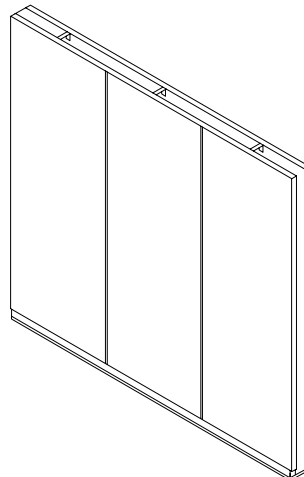
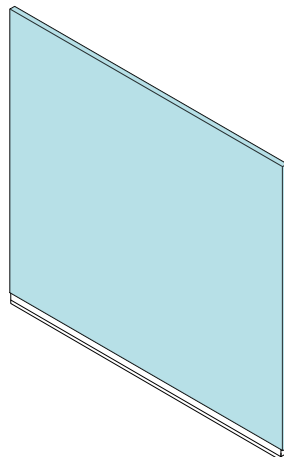
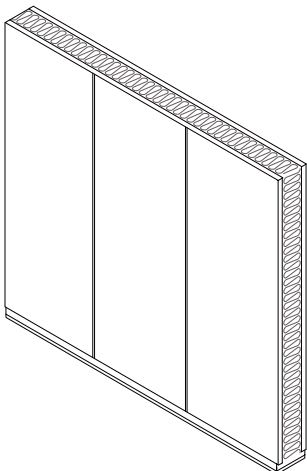

•

D82 WALL COVER

In order to achieve the perfect aesthetic integration of all spatial elements, the programme includes the D82 cover system for walls and columns. Its telescopic system is capable of absorbing uneven wall surfaces.

••

FORRO DE PARED D82

Para lograr una perfecta integración estética de todos los elementos espaciales, el programa incluye soluciones de forro D82 para paredes y pilares. Además, gracias al sistema telescópico, es posible eliminar los desniveles en las paredes.

•••

WANDVERKLEIDUNG D82

Um eine perfekte ästhetische Integration aller Raumelemente zu erreichen, haben wir die Verkleidung D82 für Wände und Säulen im Angebot. Dank des Teleskopsystems ist dieses System in der Lage, Unebenheiten an den Wänden auszugleichen.



M82 Start.
Arranque de tabique M82.
M82: Anfangselement.



M82 Single-glazed frame.
M82 Marco 1 vidrio.
M82: Rahmen 1 für Glaselement.



M82 90° Corner.
Esquina 90° M82.
M82: 90° Ecke.

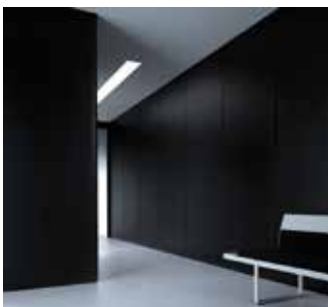

D82 wallcover.
Forro de pared D82.
Wandverkleidung D82.



Doorknob.
Pomo de puerta.
Türknauf.



Handle detail.
Detalle de manilla de puerta.
Detailansicht des Türgriff .





▼ M82 overview.
M82: vista general.
M82: Allgemeine Ansicht.





M82 CRYSTAL

M82 Crystal is an evolution of the original system which enhances the brightness and transparency of spaces through the use of see-through PMMA -Polymethyl methacrylate- components and the generous glazed areas which the system is capable of sustaining.

The frame designed for this partition lightens the structure and completes a reusable, accessible, high-performance system which can be totally integrated in with the rest of the range.

M82 Crystal es una evolución del sistema original que potencia la luminosidad y transparencia de los espacios mediante elementos transparentes de PMMA - polimetacrilato de metilo-, y a las amplias áreas de vidrio que soporta el sistema.

El marco ideado para esta partición aligera la estructura y completa un sistema de altas prestaciones técnicas, registrable, accesible, reutilizable e integrable totalmente con el resto de la gama.

M82 Crystal ist eine Weiterentwicklung des Originalsystems. Es stellt Helligkeit und Transparenz der Räume in den Mittelpunkt. Dies ist den Elementen aus Plexiglas (PMMA) sowie den großen Glasflächen, die dieses System bietet, zu verdanken.



Die Rahmenstruktur für dieses Trennwandsystem verleiht der Struktur Leichtigkeit und komplettiert dieses System, das hohen technischen Ansprüchen gerecht wird. Es ist abnehmbar, die Zwischenräume sind zugänglich, es ist wieder verwendbar, und es lässt sich perfekt mit der übrigen Produktpalette kombinieren.





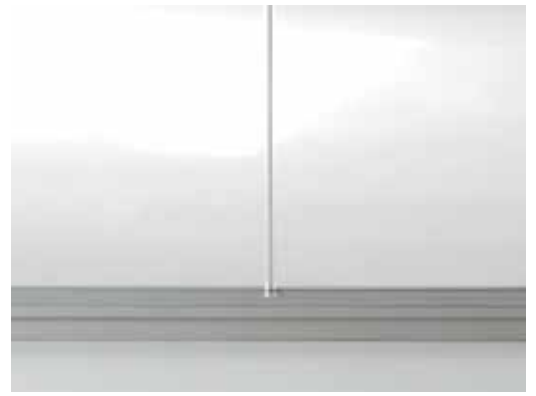

Crystal etail.
Detalle Crystal.
Rahmen Crystal.



Partition start.
Arranque tabique.
Trenwandverbindung.



Detail of frame.
Detalle de marco.
Detailansicht des Rahmens.

◀ **M82 Crystal.**
M82 Crystal.
M82 Crystal.

COATINGS

REVESTIMIENTOS • VERKLEIDUNGEN

LACQUERED
LACADOS
LACKIERUNGEN

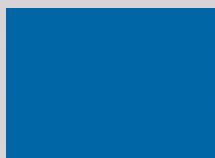

AK Electric blue
Azul eléctrico



HD Mustard yellow
Amarillo mostaza

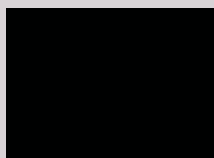

NE Black
Negro

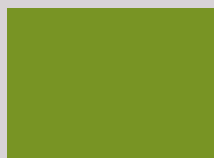

VV Spring green
Verde primavera



CV Bright red
Rojo vivo

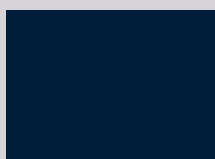

AJ Navy blue
Azul marino

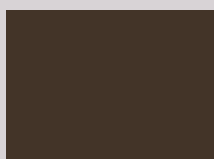

BG Chocolate
Chocolate

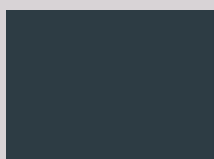

GF Deep grey
Gris profundo



GV Greenish grey
Gris verdoso



CG Burgundy
Granate



AG Storm blue
Azul roto

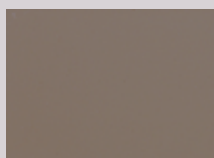

BT Mocha brown
Tostado



GA Anthracite grey
Gris antracita



VT Laurel green
Verde laurel



RO Red
Rojo



AF Ice blue
Azul gélido

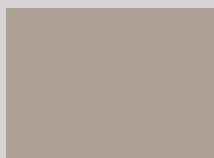

BE Smoke
Humo

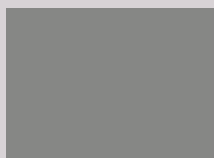

GE Mouse grey
Gris ratón

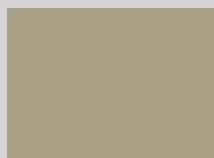

VG Khaki green
Verde caqui



CD Orange
Naranja

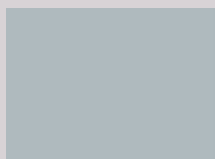

AE Grey blue
Azul grisáceo



BD Stone
Piedra

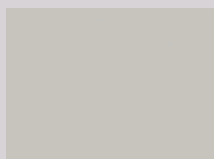

GC Light grey
Gris claro



VP Pistachio green
Verde pistacho



CC Vanilla
Vainilla

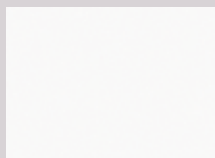

BA White
Blanco

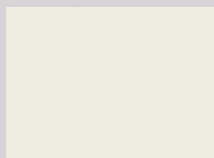

BC Cream white
Blanco crema

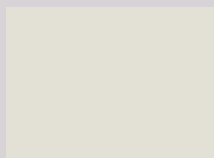

GD Off white
Blanco sucio

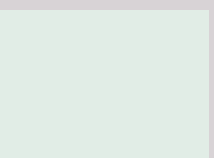

VA Sea blue
Aquamarina

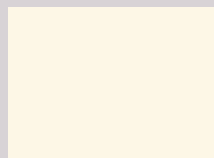

CB Faded white
Blanco roto

WOOD
MADERA
ECHTHOLZ



RB White oak
Roble blanco



MB White s.g.
Mallada blanca



NB White walnut
Nogal blanco



RG Grey oak
Roble gris



MG Grey s.g.
Mallada gris

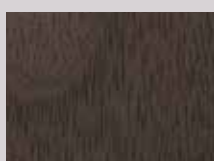

NG Grey walnut
Nogal gris



RS Black oak
Roble negro

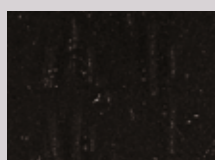

MS Black s.g.
Mallada negra



NN Walnut
Nogal



RC Cream oak
Roble crema



MC Cream s.g.
Mallada crema



NM Honey walnut
Nogal miel



RD Honey oak
Roble miel



MD Honey s.g.
Mallada miel



RP Brown oak
Roble marrón



MP Brown s.g.
Mallada marrón

VINYL
VINOLO
VINYL

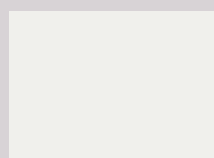

BA White
Blanco



02 Movinord white
Blanco Movinord



01 Cream
Crema



03 Sandstone
Arenisca



05 Moon grey
Gris luna



43 Aluminium
Aluminio



06 Blue
Azul



27 Beech
Haya



34 Maple
Maple



35 Decape
Decapé



26 Cherry
Cerezo

LAMINATE
MELAMINA
LAMINAT

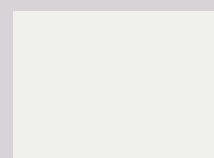

BA White
Blanco

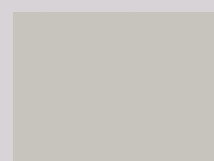

GC Light grey
Gris claro



AU Birch
Abedul



AA Acacia
Acacia

STRUCTURE AND METAL PANELS

ESTRUCTURA Y PANEL METÁLICO • STRUKTUR UND METALLPANEEL

POLYESTER PLAIN EPOXY
PINTURA EPOXY POLIESTER
EPOXY-POLYESTER-FARBE

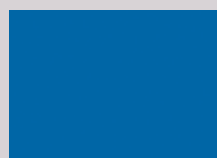

AK Electric blue
Azul eléctrico



HD Mustard yellow
Amarillo mostaza

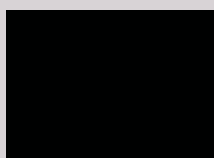

NE Black
Negro

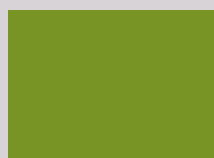

VV Spring green
Verde primavera



CV Bright red
Rojo vivo

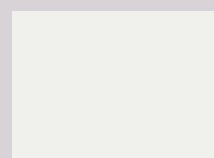

02 Movinord white
Blanco Movinord

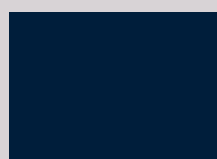

AJ Navy blue
Azul marino

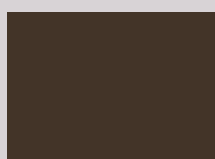

BG Chocolate
Chocolate

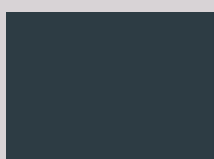

GF Deep grey
Gris profundo



GV Greenish grey
Gris verdoso



CG Burgundy
Granate

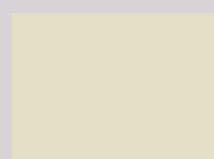

01 Cream
Crema



AG Storm blue
Azul roto

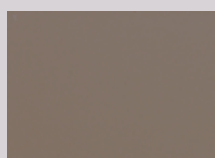

BT Mocha brown
Tostado



GA Anthracite grey
Gris antracita



VT Laurel green
Verde laurel



RO Red
Rojo



03 Sandstone
Arenisca



AF Ice blue
Azul gélido



BE Smoke
Humo



GE Mouse grey
Gris ratón



VG Khaki green
Verde caqui



CD Orange
Naranja

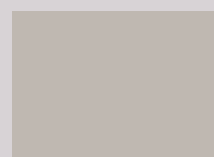

05 Moon grey
Gris luna

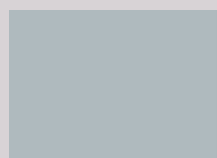

AE Grey blue
Azul grisáceo



BD Stone
Piedra

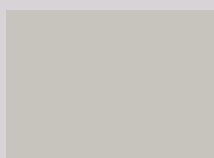

GC Light grey
Gris claro



VP Pistachio green
Verde pistacho



CC Vanilla
Vainilla



06 Blue
Azul

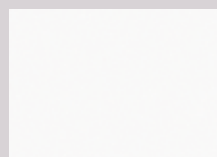

BA White
Blanco

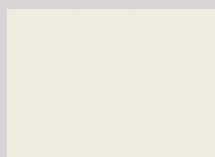

BC Cream white
Blanco crema

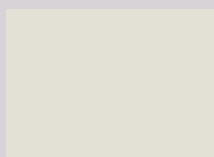

GD Off white
Blanco sucio

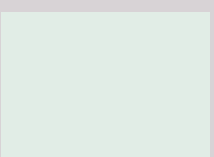

VA Sea blue
Aquamarina

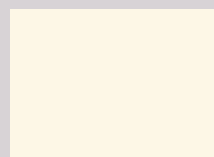

CB Faded white
Blanco roto

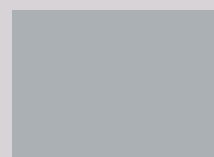

29 Mica grey
Gris mica

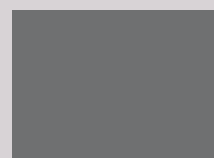

04 Marengo
Marengo

METALLIE EPOXY
PINTURA METALIZADA
METALLLACKIERUNG



8GP Platinum grey
Gris platino



8GG Graphite grey
Gris grafito

M82

CHARACTERISTICS • CARACTERÍSTICAS • EIGENSCHAFTEN

Dimensions

- Standard module width between axes: 1,200 mm.
- Standard floor/ceiling heights: 2,700 and 3,100 mm. For heights over 3,100 mm., consult the technical department.
- Height tolerance absorption capacity: ± 20 mm.
- Partition thickness: 80 mm.
- Weight/m² with plasterboard panels: 24 kg

Frame

- Visible profiling and inner frame in galvanised steel Sendzimir.
- Quality in accordance with European standard EN 10142-A1:1994. (DX51D+Z).

Paintwork

- Previously degreased.
- Electrostatically coated with polyester powder or polyester epoxy paint and polymerised at 200°C.
- Average paint coat thickness: 50/60 μ .
- Colour tolerance: standard DIN 5033.

Outer faces, mineral fibre, doors and windows

- Plasterboard or particle-board panels, with semirigid vinyl coatings, cotton-gauze or cellulosebased vinyls, to choose from the Dynamobel finish range. Other surface finish options include varnished fine hardwoods (for particle board), stratifieds, etc. Total thickness: 13 mm.
- Inner insulation with semi-rigid, 50-mm thick, 30/40 kg/m³ mineral fibre panelling.
- Flat, blind door leaves in particle board measuring 830 x 2,040 x 40 mm and weighing approximately 40 kg/unit, with the same surface finish possibilities as the panels.
- Glazed door leaf option.
- Single- and double-glazed fixed windows (52-mm gap on double glazing).
- Panes with thickness between 4 and 6 mm.

Fittings

Hinges and other metal fittings treated with the same paint, zinc, bluing coating, etc. depending on case.

Fire resistance

- Reaction to fire: B s1 d0 (Aidima, per standard EN 13501-2).
- EI30 (Aidico, per standard EN 1364-1).
- RF 60' (CTICM-France, per "Arrêté du 21 Avril 1983 du M.I.).

Acoustic insulation

- Blind module (A): Rw = 45 dB.
 - Door module (J): Rw = 37 dB.
 - Glazed module (B2g): Rw = 44 dB.
- (CSIC L. Torres Quevedo Spain per EN ISO 140-3).

Dimensiones

- Modulaci3n horizontal entre ejes est3andar: 1.200 mm.
- Alturas est3andares suelo/techo: 2.700 y 3.100 mm. Para alturas superiores a 3.100 mm., consultar con el departamento t3cnico.
- Capacidad de absorci3n de tolerancias en altura: ± 20 mm.
- Espesor del tabique: 80 mm.
- Peso/m² con tableros yeso/cart3n (plasterboard): 24 kg.

Estructura

- Perfiles vistos y estructura interna en acero galvanizado Sendzimir.
- Calidad seg3n Norma Europea EN 10142-A1:1994 (DX51D+Z).

Pintura

- Tratamiento previo de desengrase.
- Aplicaci3n electrost3tica de pintura en polvo poli3ster o epoxi-poli3ster y polimerizado en horno a 200°C.
- Espesor medio de capa de pintura: 50/60 μ .
- Tolerancia en colorido: Norma DIN 5033.

Paramentos exteriores, lana mineral, puertas y ventanas

- Tableros de yeso/cart3n (plasterboard) o tableros aglomerados de part3culas de madera con revestimientos vin3licos en semirr3gido, vinilos con soporte celul3sico o de algod3n, a elegir dentro de la colecci3n de acabados Dynamobel. Otras opciones de revestimiento posibles son las maderas nobles barnizadas (para tableros aglomerados), los estratificados, etc. Espesor total: 13 mm.
- Aislante interior con panel semirr3gido de lana mineral de 30/40 kg/m³ de densidad y 50 mm de espesor.
- Hojas de puerta planas, ciegas en aglomerado de part3culas de madera con las mismas posibilidades de revestimiento que los tableros, de dimensiones 830 x 2.040 x 40 mm y un peso aproximado de 40 kg/ud. Opci3n de hojas de puerta acristaladas.
- Ventanas fijas para uno o dos vidrios (espacio libre entre el doble vidrio de 52 mm).
- Vidrios con espesores comprendidos entre 4 y 6 mm.

Accesorios

Bisagras y resto de accesorios met3licos tratados con los mismos recubrimientos de pintura, zincados, pavonados, etc. seg3n casos.

Resistencia al fuego

- Reacci3n al fuego: B s1 d0 (Aidima, seg3n norma EN 13501-2).
- EI30 (Aidico, seg3n norma EN 1364-1).
- RF 60' (CTICM-Francia, seg3n "Arrêté du 21 Avril 1983 du M.I.).

Aislamiento ac3stico

- M3dulo ciego (A): Rw = 45 dB
 - M3dulo puerta (J): Rw = 37 dB
 - M3dulo vidriero (B2v): Rw = 44 dB
- (CSIC L. Torres Quevedo Espa1a seg3n norma EN ISO 140-3)

Ma1e

- Modulbreite zwischen Standardachsen: 1.200 mm.
- Standardh3he vom Boden bis zur Decke: 2.700 und 3.100 mm. F3r H3hen von mehr als 3.100 mm. wenden Sie sich bitte an unsere technische Abteilung.
- Ausgleichspotenzial in vertikaler Richtung: ± 20 mm.
- Dicke der Paneele: 80 mm.
- Gewicht/m² bei Gipskartonplatten: 24 kg.

Aufbau

- Sichtbare Profile und Innenstruktur aus galvanisiertem (Sendzimir-verzinktem) Stahl.
- Qualit3t nach europ3ischer Norm EN 10142-A1:1994 (DX51D+Z).

Lackierung

- Vorbehandlung zur Entfettung.
- Elektrostatische Pulverbeschichtung mit Polyester oder Epoxy mit nachfolgender Einbrennung im Ofen bei 200°C.
- Mittlere Dicke der Farbschicht: 50/60 μ .
- Farbtoleranzen: gem31 DIN-Norm 5033.

Au1enfl3chen, Mineralwolle, T3uren und Fenster

- Platten aus Gipskarton oder Pressplatten mit Beschichtungen aus halbstarrem Vinyl; Vinyl mit einer Tr3gerschicht aus Zellulose oder Baumwolle, ausw3hlbar aus den Oberfl3chen der Dynamobel-Kollektion. Weitere Optionen f3r die Verkleidung sind edle lackierte H3lzer (f3r Pressplatten), Laminate etc. Gesamtdicke: 13 mm.
- Innenisolierung mit halbstarren Platten aus Mineralwolle mit einer Dichte von 30/40 kg/m³ und einer Dicke von 50 mm.
- Flache T3urbl3tter, in nicht transparenter Ausf3hrung aus Pressholzplatten, mit den gleichen Optionen f3r die Verkleidung wie bei den Paneelen, Gr31e 830 x 2.040 x 40 mm und Gewicht von ca. 40 kg/Einheit.
- Optional auch T3urbl3tter aus Glas erh3ltlich.
- Feststehende Fenster f3r einfache oder doppelte Verglasung (Abstand zwischen doppelten Scheiben 52 mm).
- Scheiben mit Dicken von 4 und 6 mm.

Zubeh3r

Scharniere und sonstiges Metallzubeh3r mit den gleichen Lackierungen, Verzinkungen und Br3unierungen behandelt, je nach Ausf3hrung.

Feuerbest3ndigkeit

- Reaktion auf Feuer: B s1 d0 (Aidima, gem31 Norm EN 13501-2).
- EI30 (Aidico, gem31 Norm EN 1364-1).
- RF 60' (CTICM-Frankreich, gem31 "Arrêté du 21 Avril 1983 du M.I.).

Akustische Isolierung

- Nicht transparentes Modul (A): Rw = 45 dB.
 - T3urmodul (J): Rw = 37 dB.
 - Glasmodul (B2v): Rw = 44 dB.
- (nach Messungen des Technologieinstituts CSIC L. Torres Quevedo, Spanien, gem31 Norm UNE-EN 140-3).

M82 CRYSTAL

CHARACTERISTICS • CARACTERÍSTICAS • EIGENSCHAFTEN

Material

Dynamobel's M82 Crystal partitions are made of a combination of elements in two materials:

- Polymethyl methacrylate: a totally transparent, high-performance polymer, unalterable over time.
- Metal structure on floor, ceiling and door supports.

Paintwork

- Previously degreased, electrostatically coated with polyester powder or polyester epoxy paint and polymerised at 200°C.
- Average paint coat thickness: 50/60 µ.
- Colour tolerance: standard DIN 5033.

Dimensions

- Standard heights of 2,700 mm and 3,100 mm.
- Laminated 4+4, 5+5 and 6+6 mm glass.

Frame

- Standard module width:
1,200 (4+4/5+5/6+6).
2,400 (4+4/5+5/6+6).
3,600 (5+5/6+6).
> 3,600 (6+6).
- 90° PMMA joint with mitred frame.
- Polymethyl methacrylate T-joint and Cross Joint.

Mechanical resistance

Mechanical resistance demonstrated through studies at universities and following the recommendations of and information provided by the glass manufacturers.

Acoustic insulation

- In blind areas, $R_w=45$ dB.
- In glazed areas:
 $R_w=35$ dB (5+5 or 6+6 panes).
 $R_w=33$ dB (4+4 panes).

Material

Las particiones M82 Crystal de Dynamobel se componen de una combinación de elementos de dos materiales:

- Polimetacrilato de metilo: polímero de altas prestaciones totalmente transparente, sin alteraciones en el tiempo.
- Estructura metálica en suelo, techo y soporte de puertas.

Pintura

- Con tratamiento previo de desengrase, aplicación electrostática de pintura en polvo poliéster o epoxi-poliéster y polimerizado en horno a 200°C.
- Espesor medio de capa de pintura: 50/60 µ.
- Tolerancia en colorido: Norma DIN 5033.

Dimensiones

- Altura estándar de 2.700 mm y 3.100 mm.
- Vidrio laminado 4+4, 5+5 y 6+6 mm.

Estructura

- Modulación estándar:
1.200 (4+4/5+5/6+6).
2.400 (4+4/5+5/6+6).
3.600 (5+5/6+6).
> 3.600 (6+6).
- Encuentro en 90° de PMMA, con marco a inglete.
- Encuentro en T y encuentro en cruz de polimetacrilato de metilo.

Resistencia mecánica

Resistencia mecánica comprobada mediante estudios con universidades y siguiendo las recomendaciones y los datos de los fabricantes de vidrio.

Aislamiento acústico

- En zonas ciegas, $R_w=45$ dB.
- En zonas de vidrio:
 $R_w=35$ dB (vidrios 5+5 o 6+6).
 $R_w=33$ dB (vidrios 4+4).

Material

Das Trennwandsystem M82 Crystal von Dynamobel besteht aus einer Kombination von Elementen aus zwei verschiedenen Materialien:

- Plexiglas (PMMA): vollkommen durchsichtiges Hochleistungspolymer, keine Veränderungen durch Alterung.
- Metallstruktur an Boden, Decke und Türträgern.

Lackierung

- Mit vorheriger Behandlung zur Entfettung, elektrostatische Pulverbeschichtung mit Polyester oder Epoxy und nachfolgende Einbrennung im Ofen bei 200°C.
 - Mittlere Dicke der Farbschicht: 50/60 µ.
 - Farbtoleranzen: gemäß DIN-Norm 5033.
- Maße
- Standardhöhen von 2.700 mm und 3.100 mm.
 - Flachglas 4+4, 5+5 oder 6+6 mm.

Aufbau

- Standardmodule:
1.200 (4+4/5+5/6+6).
2.400 (4+4/5+5/6+6).
3.600 (5+5/6+6).
> 3.600 (6+6).
- 90°-Verbindungsstück aus Plexiglas, mit Geh-rungsrahmen.
- T-förmiges Verbindungselement und kreuzförmige Verbindung aus Plexiglas.

Stabilität

Die Stabilität wurde im Rahmen von in Zusammenarbeit mit Universitäten durchgeführten Studien nachgewiesen und wird durch konsequente Umsetzung der Empfehlungen und Daten der Glashersteller erreicht.

Akustische Isolierung

- In nicht transparenten Bereichen: $R_w=45$ dB.
- In Glasbereichen:
 $R_w=35$ dB (Glasstärke 5+5 oder 6+6).
 $R_w=33$ dB (Glasstärke 4+4).

ASSEMBLIES • CONJUNTOS • TEILESÄTZE

90° 2-pane joint and bottom-runner frame.

Unión de dos vidrios 90° y marco en rodapié.
Verbindung von zwei Glaselementen im 90°-Winkel und Rahmen am Sockel.

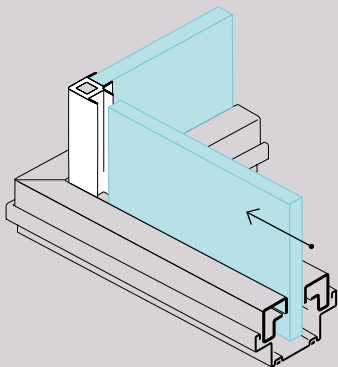

180° 2-pane joint.

Unión de dos vidrios 180°.
180°-Verbindung von zwei Glaselementen.

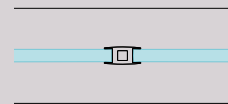

Assembly 43: Cross joint.

Conjunto 43: Unión en Cruz.
Teilesatz 43: Kreuzförmige Verbindung.

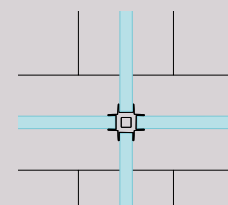

Assembly 42: T joint.

Conjunto 42: Unión en T.
Teilesatz 42: T-förmige Verbindung.

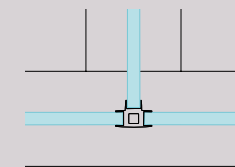

Assembly 44: 90° corner.

Conjunto 44: Esquina 90°.
Teilesatz 44: 90°-Ecke.

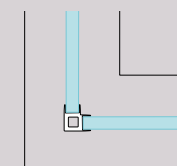

M82 + M82 CRYSTAL

HORIZONTAL SECTIONS • SECCIONES HORIZONTALES • HORIZONTAL SCHNITTE

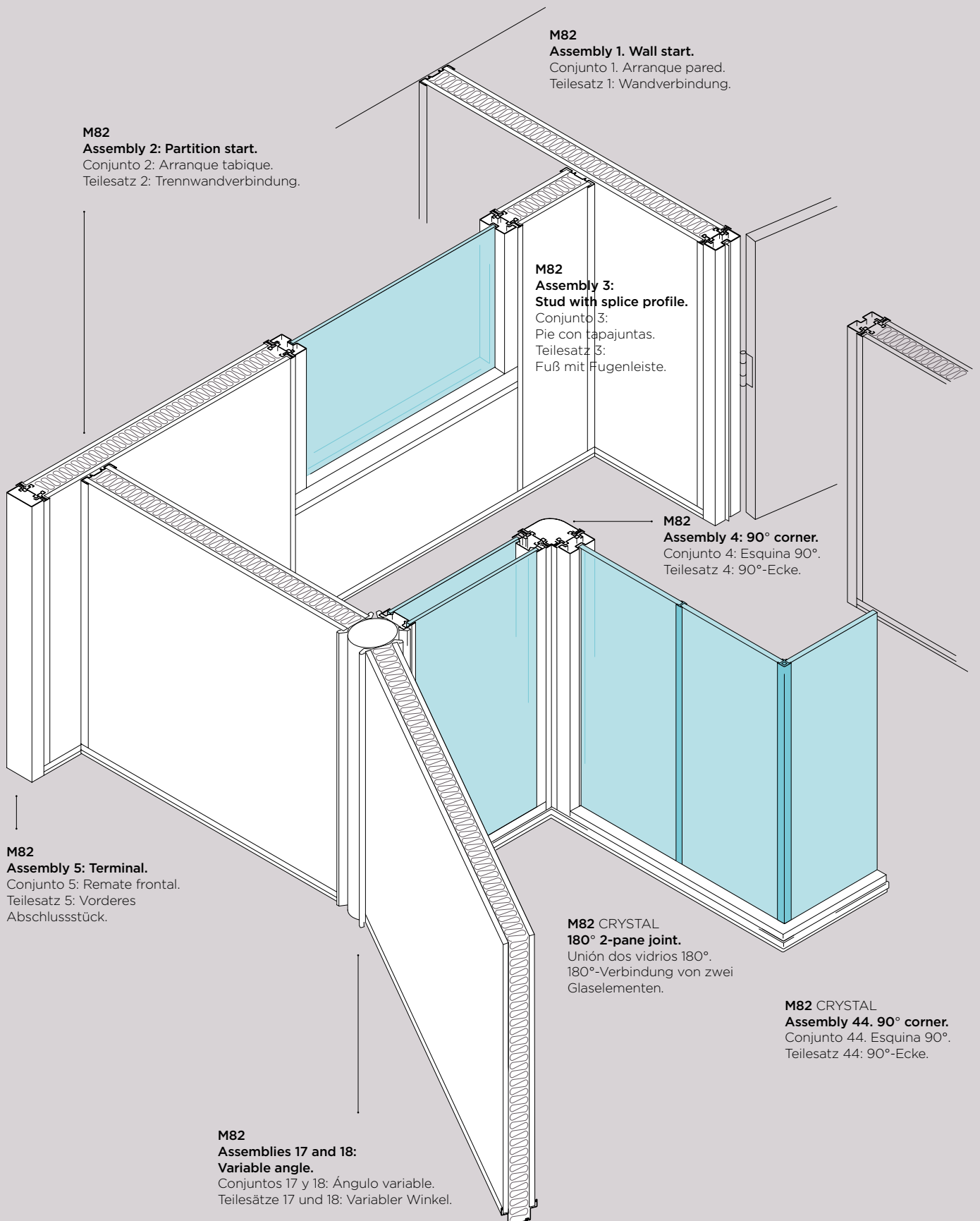

M82 + M82 CRYSTAL

VERTICAL SECTIONS • SECCIONES VERTICALES • VERTIKALE SCHNITTE

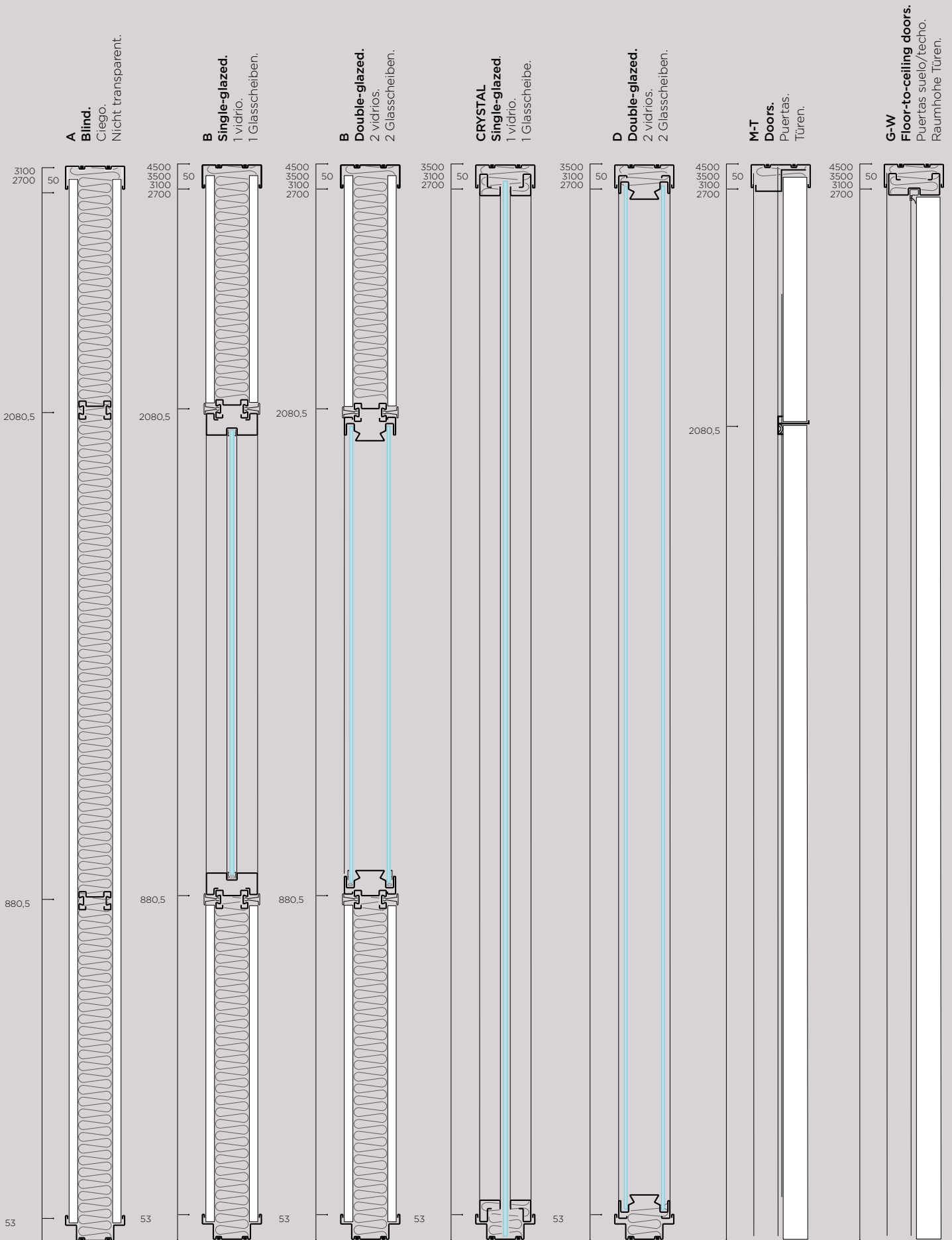

M82 + M82 CRYSTAL

STANDARD MODULES • MÓDULOS ESTANDAR • STANDARMODULE

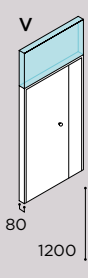
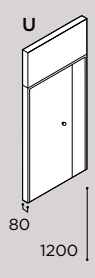
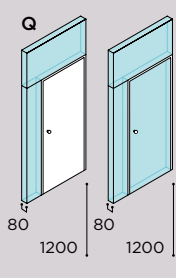
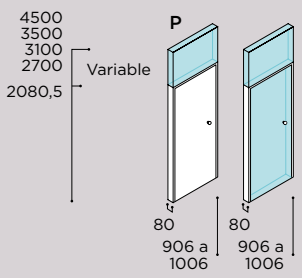
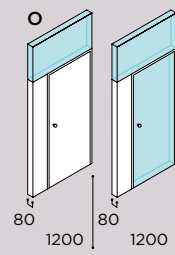
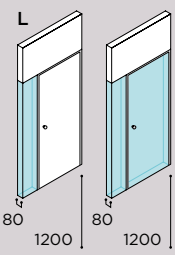
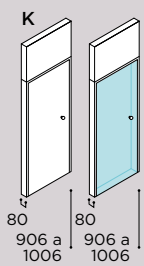
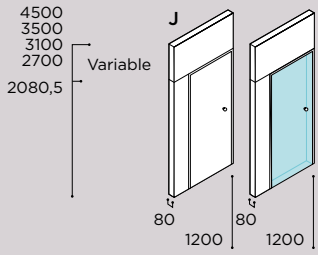
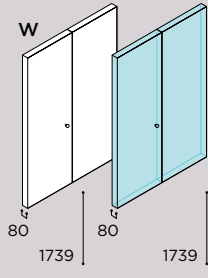
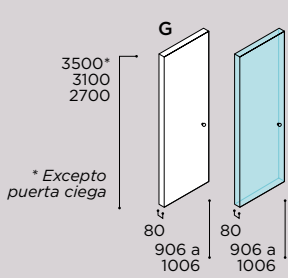
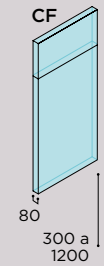
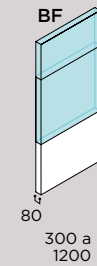
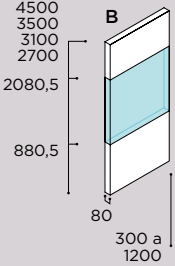
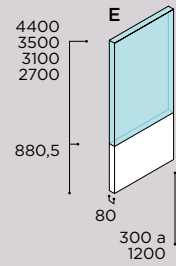
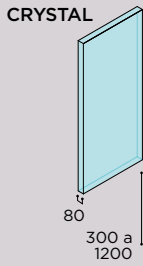
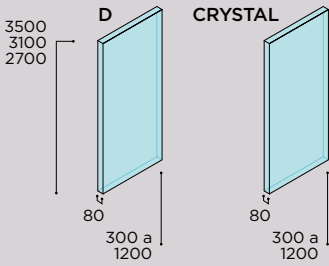
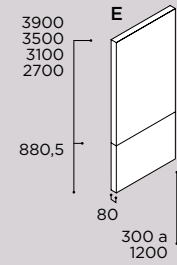
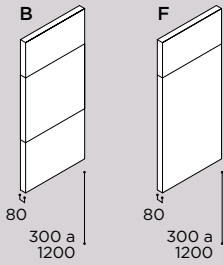
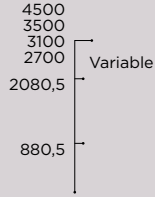
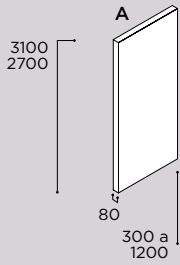

M82 + M82 CRYSTAL

STANDARD MODULES • MÓDULOS ESTANDAR • STANDARMODULE

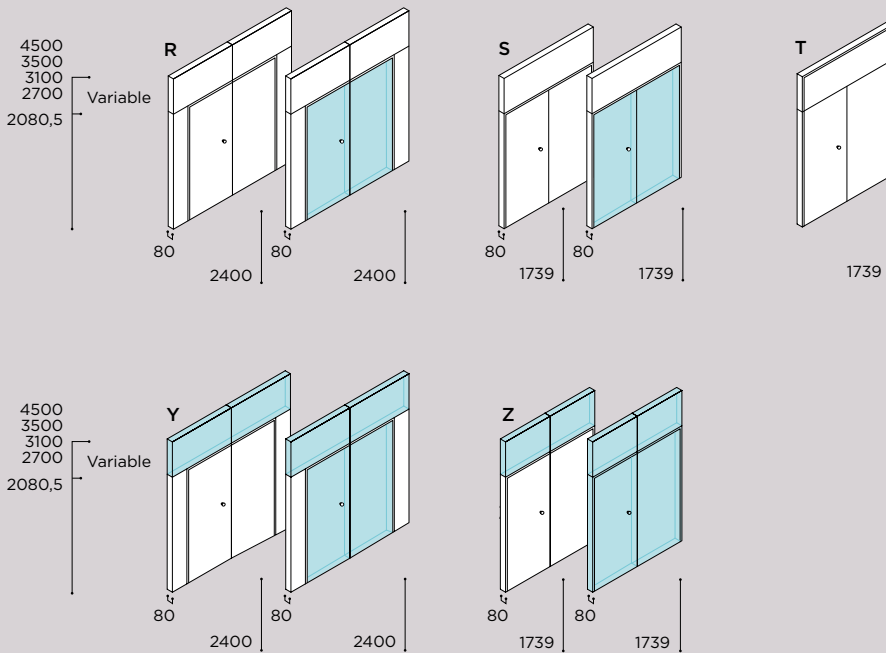

ASSEMBLIES • CONJUNTOS • TEILESÄTZE

Assembly 44: Corner.
Conjunto 44: Esquina.
Teilesatz 44: Ecke.

Assembly 3: Stud with splice profile.
Conjunto 3: Pie con tapajuntas.
Teilesatz 3: Fuß mit Fugenleiste.

Variable angles:
Assembly 17: Two-way.
Assembly 18: Three-way.
Ángulos variables:
Conjunto 17: Dos salidas.
Conjunto 18: Tres salidas.
Variable Winkel:
Teilesatz 17: Zwei Anschlussseiten.
Teilesatz 18: Drei Anschlussseiten.

Window.
Ventana.
Fenster.

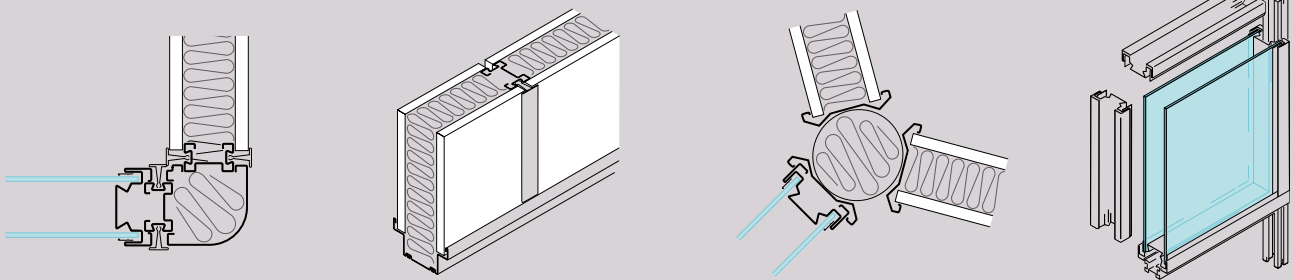

Assembly 1: Wall start.
Conjunto 1: Arranque pared.
Teilesatz 1: Anfangelement
ab Gebäudewand.

Assembly 2: Partition Start.
Conjunto 2: Arranque Tabique.
Teilesatz 2: Anfangelement
ab Trennwand.



D82

CHARACTERISTICS • CARACTERÍSTICAS • EIGENSCHAFTEN

Description

D82 wall and column cover complements the M82 demountable partition systems.

General dimensions

- Standard module width between axes: 1,200 mm.
- Standard floor/ceiling heights: 2,700 and 3,100 mm.
- Height tolerance absorption capacity: ± 20 mm.
- Cover thickness: 38 -118 mm.

Frame

- Visible profiling and inner frame in Sendzimir galvanised steel.
- Quality in accordance with European standard EN 10142-A1:1994 (DX51D+Z).

Paintwork

- Previously degreased.
- Electrostatically coated with polyester powder or polyester epoxy paint and polymerised at 200°C.
- Average paint coat thickness: 50/60 μ .
- Colour tolerance: Standard DIN 5033.

Outer faces, mineral fibre

- Particle-board panels, edged and laminated with semi-rigid vinyl coatings, cotton-gauze or cellulose-based vinyls. Other surface finish options include fine hardwoods (for particle panels), stratifieds, etc. to choose from the Dynamobel finish range. Total thickness: 13 mm.
- Inner insulation with semi-rigid, 20-mm thick, 30/40 kg/m³ mineral fibre panelling.

Levelling

The cover incorporates a telescopic system which caters for the absorption of uneven wall surfaces of up to 80 mm.

Fittings

Metal fittings treated with the same paint, zinc, bichromate, etc. depending on case.

Demountability and re-installation

Complete, independent demountability of all components: on D82 by clipping horizontal and vertical splice profiles along the length of the structure.

Descripción

El forro de pared y pilares D82 es un complemento a los sistemas de particiones desmontables M82.

Dimensiones generales

- Modulación horizontal entre ejes estándar: 1.200 mm.
- Alturas estándar suelo/techo: 2.700 y 3.100 mm.
- Capacidad de absorción de tolerancias en altura: ± 20 mm.
- Espesor del forro: 38 -118 mm.

Estructura

- Perfiles vistos y estructura interna en acero galvanizado Sendzimir.
- Calidad según Norma Europea EN 10142-A1:1994 (DX51D+Z).

Pintura

- Tratamiento previo de desengrase.
- Aplicación electrostática de pintura en polvo poliéster o epoxi-poliéster y polimerizado en horno a 200°C.
- Espesor medio de capa de pintura: 50/60 μ .
- Tolerancia en colorido: Norma DIN 5033.

Paramentos exteriores, lana mineral

- Tableros aglomerados de partículas de madera, canteados y aplacados con los revestimientos vinílicos en semirrígido, vinilos con soporte celulósico o de algodón. Otras opciones de revestimiento son las maderas nobles (para tableros aglomerados), los estratificados, etc. a elegir dentro de la colección de acabados Dynamobel. Espesor total: 13 mm.
- Aislante interior con paneles semirrígidos de lana mineral de 30/40 kg/m³ de densidad y 20 mm de espesor.

Nivelación

El forro está dotado de un sistema telescópico que permite la absorción de desniveles en paredes de hasta 80 mm.

Accesorios

Accesorios metálicos tratados con los mismos recubrimientos de pintura, cincados, bicromatados, etc. según casos.

Desmontabilidad y reinstalación

Desmontabilidad completa e independiente de todos los componentes: en el D82, por la fijación mediante tapajuntas horizontales y verticales que se ensamblan a clip en toda la longitud de la estructura.

Beschreibung

D82, Die Verkleidung für Wände und Säulen ist ein ergänzendes Programm zum versetzbaren Trennwandsystem M82.

Allgemeine Abmessungen

- Modulbreite zwischen Standardachsen: 1.200 mm.
- Standardhöhe vom Boden bis zur Decke: 2.700 und 3.100 mm.
- Ausgleichspotenzial in vertikaler Richtung: ± 20 mm.
- Dicke der Verkleidung: 38 -118 mm.

Aufbau

- Sichtbare Profile und Innenstruktur aus galvanisiertem (Sendzimir-verzinktem) Stahl.
- Qualität nach europäischer Norm EN 10142-A1:1994 (DX51D+Z).

Lackierung

- Vorbehandlung zur Entfettung.
- Elektrostatische Pulverbeschichtung mit Polyester oder Epoxy mit nachfolgender Einbrennung im Ofen bei 200°C.
- Mittlere Dicke der Farbschicht: 50/60 μ .
- Farbtoleranzen: Gemäß DIN-Norm 5033.

Außenflächen, Mineralwolle

- Platten aus Pressholz, Kantenbesäumung und Beschichtungen aus halbstarrem Vinyl; Vinyl mit einer Trägerschicht aus Zellulose oder Baumwolle. Weitere Optionen für die Verkleidung sind edle Hölzer (für Pressplatten) sowie Laminate etc, die aus den Oberflächen der Dynamobel-Kollektion ausgewählt werden können. Gesamtdicke: 13 mm.
- Innenisolierung mit halbstarren Platten aus Mineralwolle mit einer Dichte von 30/40 kg/m³ und einer Dicke von 20 mm.

Ausgleich von Unebenheiten

Die Verkleidung besitzt ein Teleskopsystem, über das Unebenheiten und Höhenunterschiede bis zu 80 mm kompensiert werden können.

Zubehör

Metallzubehör mit den gleichen Lackierungen, Verzinkungen und Bichromat-Verzinkungen etc. behandelt, je nach Ausführung.

Abbau und Wiedereinbau

Komplette und unabhängige Abbaubarkeit aller Komponenten: Beim System D82 gegeben aufgrund der Befestigung über horizontale Fugenleisten mit Clipbefestigung üb.

STANDARD MODULES • MÓDULOS ESTANDAR • STANDARMODULE

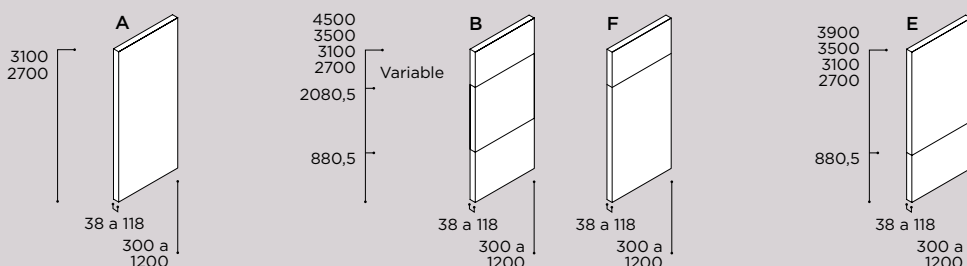

D82

SECTIONS AND ANCHORING • SECCIONES Y ANCLAJES • CHNITTE UND VERANKERUNGEN

VERTICAL SECTION
SECCIÓN VERTICAL
VERTIKALER SCHNITT

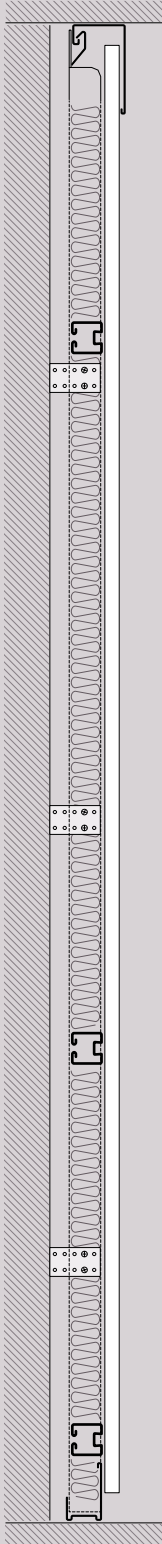

HORIZONTAL SECTIONS
SECCIONES HORIZONTALES
HORIZONTALE SCHNITTE

Assemblies 1 and 2:
Wall and partition starts.
Conjuntos 1 y 2:
Arranques de pared y tabique.
Verbindungen 1 und 2:
Verbindungen mit
Gebäudewand und Trennwand.

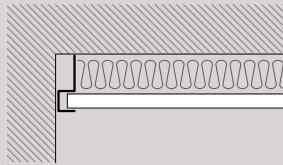

Assembly 3: Stud.
Conjunto 3: Pie.
Teilesatz 3: Fuß.

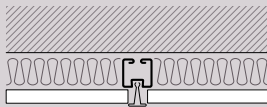

Assembly 20: 90/40 outer corner.
Conjunto 20:
Esquina exterior 90/40.
Teilesatz 20: Außenecke 90/40.

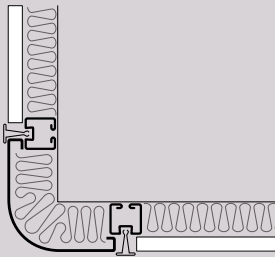

Assembly 22: 90/3 outer corner.
Conjunto 22:
Esquina exterior 90/3.
Teilesatz 22: Außenecke 90/3.

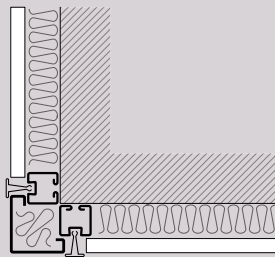

ANCHORS
ANCLAJES
VERANKERUNGEN

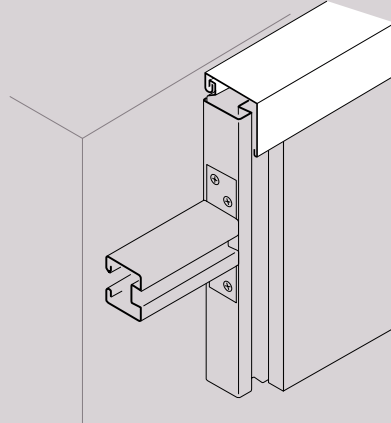

Self-supporting system.
Sistema autoportante.
Selbsttragendes System.

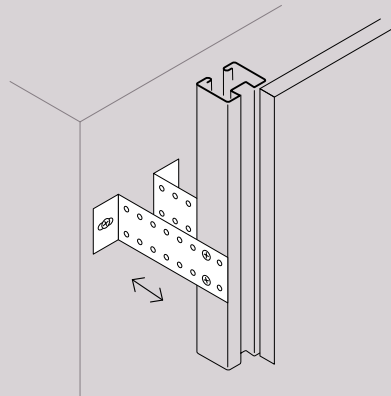

Adaptable anchoring.
Anclaje adaptable.
Anpassbare Verankerung.

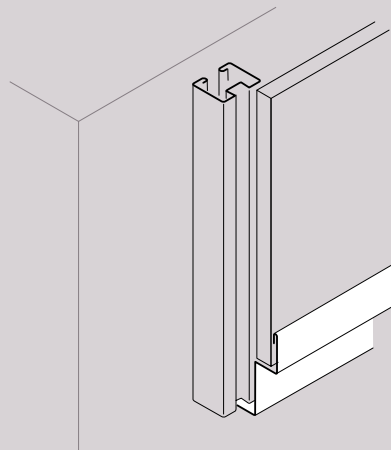

Bottom-runner with adjustable leveller.
Rodapié con nivelador regulable.
Sockel mit Höheneinstellung.

Dynamobel S.A.

CENTRAL INBOX, SPAIN

Ctra. Madrid Km 24
31350 Peralta
Navarra, Spain
T +34 948 750 000
F +34 948 750 750
info@dynamobel.com

CENTRAL BOX, SPAIN

Ctra. de Guipúzcoa Km 7,5
Apdo. 1074 31080 Pamplona
Navarra, Spain
T +34 948 303 171
F +34 948 302 581
info@dynamobel.com

DESIGN DYNAMOBEL
PHOTOGRAPHY LUIS PRIETO, MARTIN & ZENTOL

KJM/CAT/044/11

© DYNAMOBEL. ALL RIGHTS RESERVED.
REPRODUCTION OF THE WHOLE OR ANY PART
OF THE CONTENTS IS PROHIBITED.

We are breaking out of the rigid structure through which many companies in the sector impose standard solutions without questioning the constraints these place on good ideas.

Our aim is to venture beyond, stay one step ahead, because we believe that good ideas deserve more than a simple, all-embracing solution.

We work to understand designers and look into ways of solving their work, providing a suitable balance between customisation and industrialisation. Good ideas do not compromise form or function. We will defend that come what may.

Nos salimos de la estructura rígida de muchas empresas del sector en el que se imponen soluciones estándar sin cuestionarse las limitaciones que éstas imponen en las buenas ideas.

Nuestro propósito es ir más allá, un paso por delante, porque creemos que las buenas ideas merecen más que una solución masiva.

Trabajamos por entender a los creadores y explorar formas de resolver sus obras, que ofrezcan un adecuado equilibrio entre personalización e industrialización. Las buenas ideas no comprometen forma ni función. Defenderemos esto ante todo.

Wir haben uns von den starren Strukturen gelöst, in denen viele Unternehmen des Sektors verharren, indem sie Standardlösungen bieten, ohne sich dabei die Frage zu stellen, in welchem Maße diese die Umsetzung guter Ideen einschränken.

Wir haben es uns zum Ziel gesetzt, weiter zu denken und immer einen Schritt voraus zu sein, denn wir sind überzeugt, dass eine gute Idee mehr verdient als einfach nur eine vorgefertigte Lösung.

Wir bemühen uns, die Menschen, die Ideen entwickeln, zu verstehen, und versuchen, Mittel und Wege zu finden, um diese Ideen zu verwirklichen, ohne dabei jedoch ein angemessenes Gleichgewicht zwischen Individualität und Standardisierung aus dem Auge zu verlieren. Gute Ideen beeinträchtigen weder Form noch Funktion. Diesen Standpunkt vertreten wir mit allem Nachdruck.

