

MODEL NUMBER:

- R520 Rough Valve Body only**
 1/2" NPT inlets/outlets. With separate volume control. LESS Trim.
- R540 Rough Valve Body only**
 3/4" NPT inlets/outlets. With separate volume control. LESS Trim.

NOTE:
 • When used as a Bath/Shower:
 EITHER
 - a separate diverter valve (such as R420 or R430)
 OR
 - a diverter tub spout (requires twin ell)
 IS REQUIRED

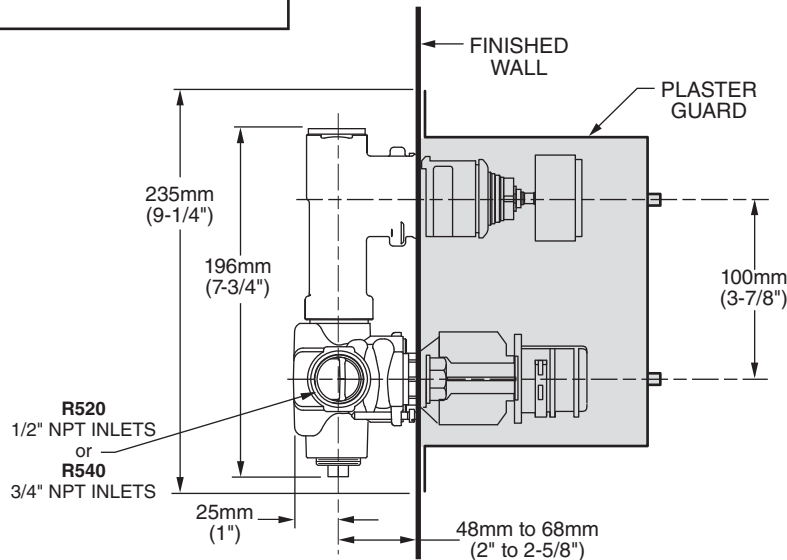

GENERAL DESCRIPTION:

Cast brass valve body. The single unit contains two handles, the bottom handle sets the desired temperature and the metal top handle functions as an on/off, volume control. The temperature is maintained by a wax element moving a shuttle valve between hot and cold. The volume is controlled by twin ceramic disc valve cartridges. Ceratherm includes Hot Limit Safety Stop. Maximum temperature limit is 112°F. Available with 1/2" or 3/4" NPT inlets and outlets.

PRODUCT FEATURES:

Brass Casting: Highest quality faucet material for durability & long life.

Wax Thermostatic Unit: Permits shuttle valve to move between the hot and cold seats to maintain the pre-selected constant water temperature.

Back to Back Capable: Hot and cold can be reversed.

Spring-Loaded Check Valves: When the hot and cold water enters the fitting, both supplies pass through the spring-loaded check valves to prevent cross flow of hot and cold water.

Integrated Stop Valves: Ensure easy cleaning and servicing.

Adjustable Hot Limit Safety Stop: Limits the amount of hot water allowed to mix with cold. Reduces the risk of accidental scalding. Maximum water temperature limit may be reduced to 104 or 109 degrees Fahrenheit.

SUGGESTED SPECIFICATION:

Two handle Thermostat shall feature a cast brass valve body. Thermostat shall be a wax element shuttle valve. Shall also feature ceramic disc valving, 1/2" NPT or 3/4" NPT inlets and outlets. Fitting shall be American Standard Model # R5_0.

CODES AND STANDARDS

These products meet or exceed the following codes and standards:

- ASSE 1016
- ASME A112.18.1
- CSA B125.1

 Meets the American Disabilities Act Guidelines and **ANSI A117.1** Requirements for the physically challenged.

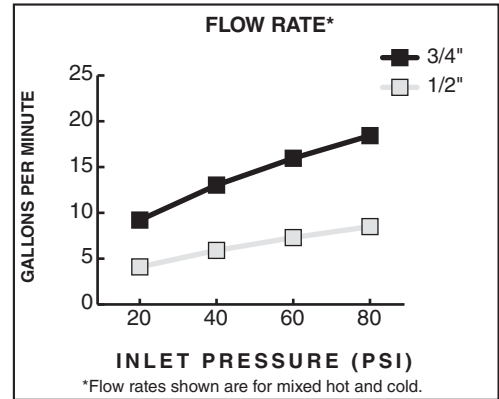











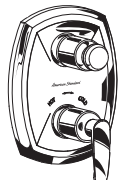

ROUGH VALVE BODIES **	Product Number	Description
	R520*	Rough Valve Body Less Trim - 1/2" NPT inlets/outlets
	R540*	Rough Valve Body Less Trim - 3/4" NPT inlets/outlets

NOTES:

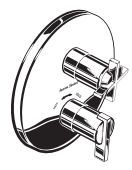
- * When used as a Bath/Shower a separate diverter valve is required (such as R420 or R430). Requires Twin Ell for use with diverter spouts. Use one discharge port only. Plug is provided.
- ** ROUGH & TRIM MUST BE ORDERED SEPARATELY.

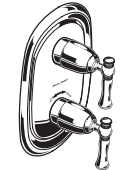
R520 and R540 will accept the following trims:

AVAILABLE TRIM KITS	Town Square®	Serin®	Green Tea®	Copeland™	Times Square™
					
	T555.740	T064.740 	T010.740 	T005.740	T184.740 
	Moments®	Berwick®	Portsmouth®	Quentin™	
					
	T506.740 	T430.740	T420.740	T440.740 