

Cast Centerset Faucets 4" Centers

TECK[®]
COMMERCIAL

DELTA[®]

Specification: (example)

- **HEAVY DUTY CAST BRASS** centerset faucet
 - 102mm (4") centers, two handle
 - Polished chrome plated finish with polished underspout
 - Metal hold-down package
 - Color indexed metal handles with vandal resistant screws
 - **CER-TECK[®]** 1/4 turn ceramic structures
- and ... with ... (add product variation required)
with ... (add outlet required)
with ... (add handle required)
with ... (add suffix **-TI** if required – See Back Page)

21C143



21C144



Engineer/Architect Approval

















Model Specified:

Approval:

Date:

DESCRIPTION	PRODUCT NO.			
4" Centerset Faucet	21C			



PRODUCT VARIATION	OUTLET	HANDLE
0 <input type="checkbox"/>	0 <input type="checkbox"/>	0 <input type="checkbox"/>
1 Standard Product Less Pop-up (No Pop-up Hole)  <input type="checkbox"/>	1 <input type="checkbox"/>	1 Five Flute Handles  <input type="checkbox"/>
2 Standard Product With Metal Pop-up  <input type="checkbox"/>	2 Vandal Resistant 1.5 gpm (5.7 L/min.) Laminar w/Agion [®] Antimicrobial  <input type="checkbox"/>	2 102mm (4") Hooded Blade Handles (1)  <input type="checkbox"/>
3 Standard Product with Cast Open Grid Strainer (No Pop-up Hole)  <input type="checkbox"/>	3 Vandal Resistant 1.5 gpm (5.7 L/min.) Flow Control Aerator  <input type="checkbox"/>	3 76mm (3") Hooded Lever Handles (1)  <input type="checkbox"/>
4 Standard Product With Cast Offset Open Grid Strainer (No Pop-up Hole)  <input type="checkbox"/>	4 Standard 1.5 gpm (5.7 L/min.) Flow Control Aerator  <input type="checkbox"/>	4 102mm (4") Blade Handles, Sanitary Hoods (1)  <input type="checkbox"/>
5 Standard Product With Chain Stay Less Plug & Chain  <input type="checkbox"/>	5 Vandal Resistant 0.5 gpm (1.9 L/min.) Non-Aerating Spray Outlet  <input type="checkbox"/>	5 152mm (6") Wrist Handles, Sanitary Hoods  <input type="checkbox"/>
6 <input type="checkbox"/>	6 <input type="checkbox"/>	6 <input type="checkbox"/>
7 <input type="checkbox"/>	7 <input type="checkbox"/>	7 <input type="checkbox"/>
8 <input type="checkbox"/>	8 <input type="checkbox"/>	8 76mm (3") Self-Closing Hooded Lever Handles  <input type="checkbox"/>
9 <input type="checkbox"/>	9 Vandal Resistant 0.35 gpm (1.32 L/min.) Non-Aerating Spray Outlet  <input type="checkbox"/>	9 Five Flute Self-Closing Handles  <input type="checkbox"/>

See Series 27C4, 27C5 for 4" Gooseneck Spout Centersets. (1) H & C Temperature Indicator available. Add suffix **-TI**. Refer to www.specselect.com for individual models.

Flow Rates are at 60 PSI. Note: Use this page front and back as a product submittal sheet.

Delta reserves the right (1) to make changes in specifications and materials, and (2) to change or discontinue models, both without notice or obligation. Dimensions are for reference only. See current full-line price book or www.specselect.com for finish options and product availability.

DSP-21C Rev. A

Approvals:

- CSA certified
- Complies to ASME A112.18.1/CSA B125.1
- Handles No. 2, 3, 4 and 5
Indicates compliance to ICC/ANSI A117.1
- Verified compliant with 0.25% weighted average Pb content regulations

(Contact Delta Representative for State and/or Local Approvals.)

HANDLE TEMPERATURE INDICATORS

- Add suffix **"-TI"** to Product Number for handle temperature indicators "H" (red), "C" (blue). Available on handle options 2, 3 or 4 only.

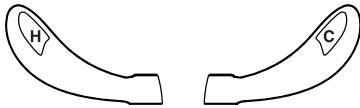

FLOW RATE vs PRESSURE

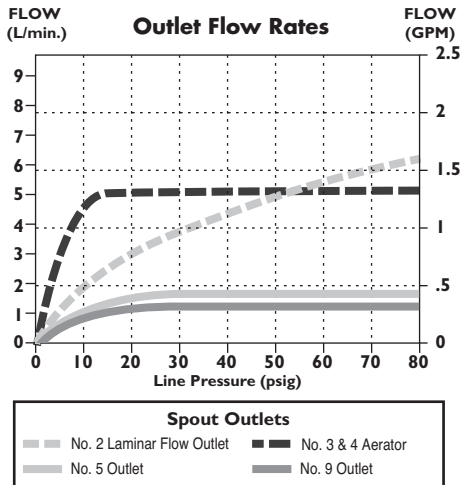

CAST SPOUT OUTLET NO.	"D"	
	mm	in.
2	11	0.45
3	11	0.45
4	11	0.45
5	11	0.45
9	11	0.45

INLETS - 1/2" MIP/Coupling Nuts

Note: Measurements may vary \pm 6mm (0.25")

Refer to www.specselect.com for individual models.

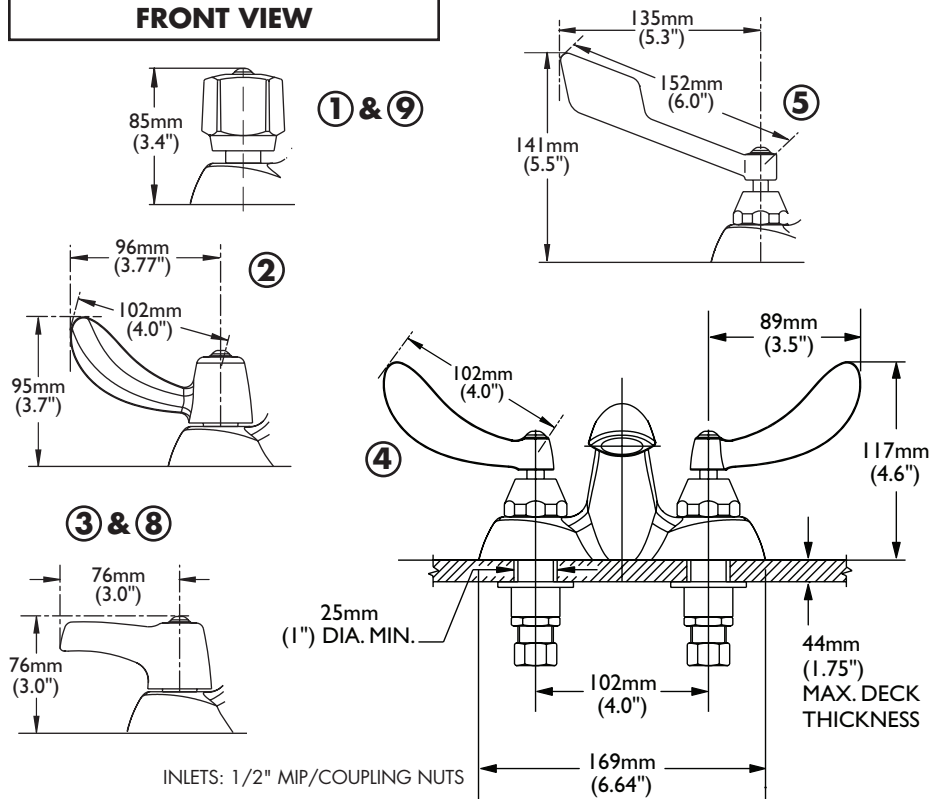
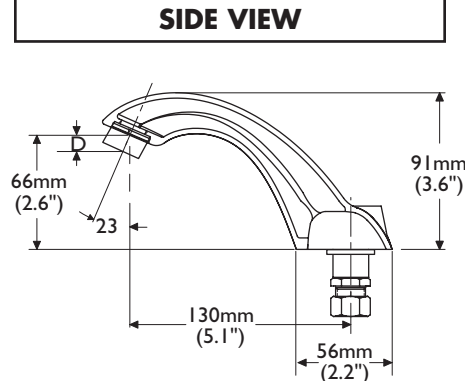
FRONT VIEW

SIDE VIEW

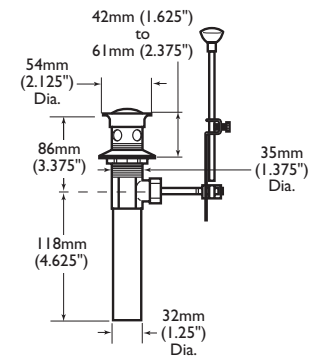
METAL POP-UP

(supplied with Product Variation 2)

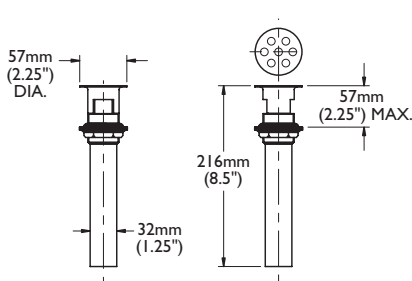
OPEN GRID STRAINER

(supplied with Product Variation 3)

OFFSET OPEN GRID STRAINER

(supplied with Product Variation 4)

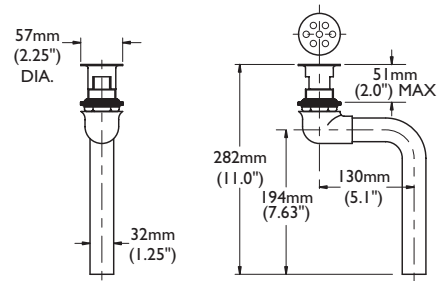

Note: Use this page front and back as a product submittal sheet.