



A GUIDE TO UNDERSTANDING INDOOR AIR QUALITY SOLUTIONS



Is Indoor Air Quality Important?

The American Lung Association® lists poor indoor air quality (IAQ) as a serious problem facing homeowners because of today's tighter homes. Outside air stays out, while air pollutants, excessive humidity and/or overly dry conditions stagnate the indoor air over time.

ALLERGEN CONCERNS

Pollen, mold spores and other common allergens, as well as bacteria and viruses in indoor air can be an issue.

COMFORT CONCERNS

High humidity can keep a home damp and sticky, while excessive dryness can crack woodwork and antiques, or create static electricity and dry skin. In addition, microscopic particles in the air slowly stain walls, ceilings, furniture, drapes and carpets, making a home feel less welcoming.

OFFER SOLUTIONS

Homes need properly balanced indoor air quality. Use the solutions in this guide to help your customers improve comfort in their homes.

Three Ways To Improve Indoor Air Quality

SOURCE CONTROL

Eliminate air pollutants before they enter the home. For example, some homeowners may not allow smoking or pets in the home, but that isn't practical for most people. Instead, stop contaminant problems before they start by installing whole-house humidifiers, dehumidifiers, ventilators and UV treatment systems.

DILUTION

Out with the old air, in with the new. This can be accomplished by opening windows, but that wastes heating and cooling energy. Energy-efficient ERV and HRV ventilation systems exchange indoor air for outdoor air while recovering most of the energy used to heat or cool the air being exhausted. This treated fresh air can then be efficiently further conditioned by an air cleaner, dehumidifier and UV treatment system.

REDUCTION

As air circulates in the home, the number of particulates are reduced during each pass through air cleaners installed just ahead of the heating and cooling equipment. This helps maintain a steady flow of cleaner air.

Understanding Airborne Particles

Every cubic foot of air you breathe carries a mixture of millions of airborne particles so small you could fit 749 of them in the eye of a needle! These include:

- Pollen and spores
- Human skin flakes
- Candle soot
- Infiltrating dust
- Viruses, bacteria and fungi
- Pet dander
- Tobacco or wood smoke
- Cooking smoke and airborne grease
- Radon gas seeping through the walls and foundations
- Chemical fumes and volatile organic compounds generated by household cleaners

Count on Resideo's vast lineup of air filters and air cleaners to help filter certain particles to improve indoor quality.



Resideo Is Your Trusted IAQ Resource



PROVEN EXPERIENCE

Resideo is your source for Honeywell Home solutions, backed by more than 100 years in the heating and cooling business and over 60 years producing IAQ products. Resideo's experience and knowledge — combined with feedback from hundreds of contractors across North America — allows us to develop IAQ product solutions that work with today's varying systems and unique applications. When it comes to comfort and indoor air quality, you can count on Resideo to deliver solutions that maximize efficiency, effectiveness and performance.

CUSTOMER DRIVEN INNOVATION

When it comes to product design, Resideo's experience is just the beginning. It's the practical use of customer insights that make Resideo innovations the kinds that contractors are comfortable installing and homeowners are comfortable using.

- Honeywell Home Humidifiers — Installation ease and flexibility with a more consistent level of humidity.
- PopUP™ Media Replacement Filter — A high efficiency filter with no assembly required, less storage space and increased replacement sales.

From Air Cleaners to Dehumidification, Resideo has listened and will continue to listen to your needs and provide the highest-quality, innovative HVAC product solutions.

PROVEN EXPERIENCE

Resideo backs every product — and every contractor and homeowner — with unmatched technical, product and sales support. From a network of knowledgeable local sales reps and toll-free support to online and on-site training to product websites, Resideo delivers support as innovative and top-quality as its products.

CONTACT

- Customer Support 855-381-3530
- Pro PERKS support 1-800-919-4835
- Order Support Lines

ONLINE RESOURCES

- www.resideo.com/pro
- www.forwardthinking.resideo.com
- www.customer.resideo.com
- www.literature.resideo.com

Local Support Through Your Resideo Contractor Development Specialist

Learn more about available Resideo support on the back cover.



All-In-One Control

Resideo's experience and insights help us develop solutions that match the preferences of homeowners, such as ease of use and no clutter on the wall.

EASIER TO USE

All-in-one controls combine temperature control and IAQ control into one convenient thermostat. So rather than a thermostat, humidistat and ventilation control, homeowners can have one attractive, easy-to-use control on the wall.

EASIER TO INSTALL

Resideo's complete selection lets you choose the all-in-one control with the options that best suit your needs: WiFi, wired, smart device integration, fan control, wireless sensors and more.

EASIER TO CONTROL

Because all of the elements are integrated into one intelligent control, the home's system works more effectively.

Whether you need to control one IAQ product or an entire system from one control, Resideo offers the ideal choice to meet your needs.

Honeywell Home IAQ Solutions

TEMPERATURE



WHOLE HOME HUMIDIFICATION



WHOLE HOME DEHUMIDIFICATION



WHOLE HOME AIR CLEANERS



FRESH AIR VENTILATION



UV SYSTEMS



Air Filtration and Performance

Use air filtration efficiency ratings and the importance of maintaining airflow as the filter gets dirty to help homeowners compare air-cleaning options.

MEASURING AIR FILTRATION PERFORMANCE

Every time the furnace or air conditioner blower operates, it circulates air through the ductwork. The force it must overcome to move this air is called “static pressure.” Because air cleaners are designed to capture particles, they present a barrier to airflow. This is important because air cleaner efficiency ratings can be related to static pressure and pressure drops. Achieving an apples-to-apples comparison between different air cleaners can be a difficult task because manufacturers may measure efficiency at different airflows and pressures.

TYPES OF EFFICIENCY TESTING

Air filtration efficiency depends on the type of air cleaner used, and the type, number and size of the particles in the air stream. The lowest ratings are typically found on ordinary throw-away fiberglass filters. Resideo’s electronic air cleaner has one of the highest ratings.

- Fractional Efficiency Testing measures the efficiency of media filters and electronic air cleaners by size of particle captured. The higher the test figure, the higher the efficiency.
- Minimum Efficiency Reporting Value (MERV) is based on Fractional Efficiency Testing and measures the efficiency of media air filters and cleaners that have been in service for a period of time. The higher the media MERV rating, the better the efficiency over the life of the filter. See page 10 for more detail.
- Weight Arrestance Testing measures the weight of particles trapped by the air cleaner and is typically used for filters that have a MERV below 4. A small fraction of all particles (10%) account for 99% of the weight of all particles in the air. These heavy particles tend to settle from the air before reaching an air cleaner.
- Initial pressure drop measures the decrease in air pressure across new media filters or recently cleaned electronic air cleaners. The lower the pressure drop, the better the airflow in the HVAC system.
- Resideo air cleaners are tested using the Fractional Efficiency Testing, MERV Testing, and Initial Pressure Drop measurements. Weight Arrestance Testing does not differentiate high-efficiency filters.

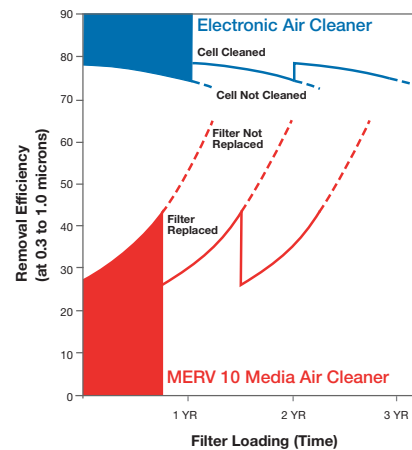

Our electronic air cleaners stay highly efficient between washings, and cause much less pressure drop when dirty.

FILTER EFFICIENCY

This chart illustrates the efficiency of different filter types based on particle size.

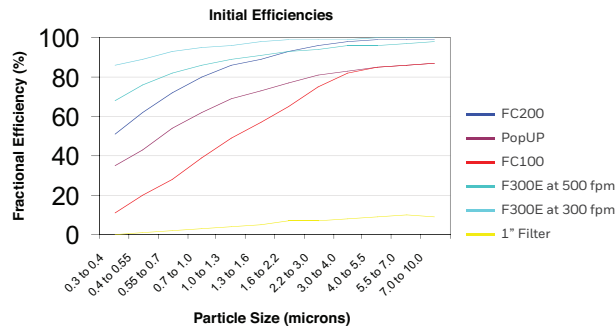

FILTER LIFE

This chart illustrates increasing pressure drop as the filter gets dirty.

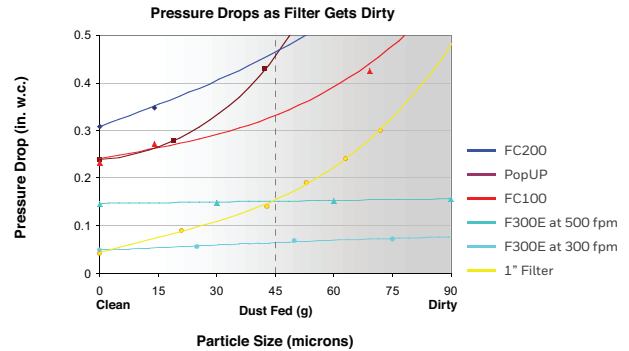

Growing Demand

Consumer demand for air cleaners has been on the rise in recent years. According to the Environmental Protection Agency (EPA), indoor air can be 2 – 5 times more polluted than outdoor air. Informing homeowners of how filtered air can increase overall comfort is an important selling point.

SIGNS THAT A HOME NEEDS AIR FILTRATION



- Pets
- Portables in multiple locations
- Central air conditioning

TYPICAL INSTALLATIONS

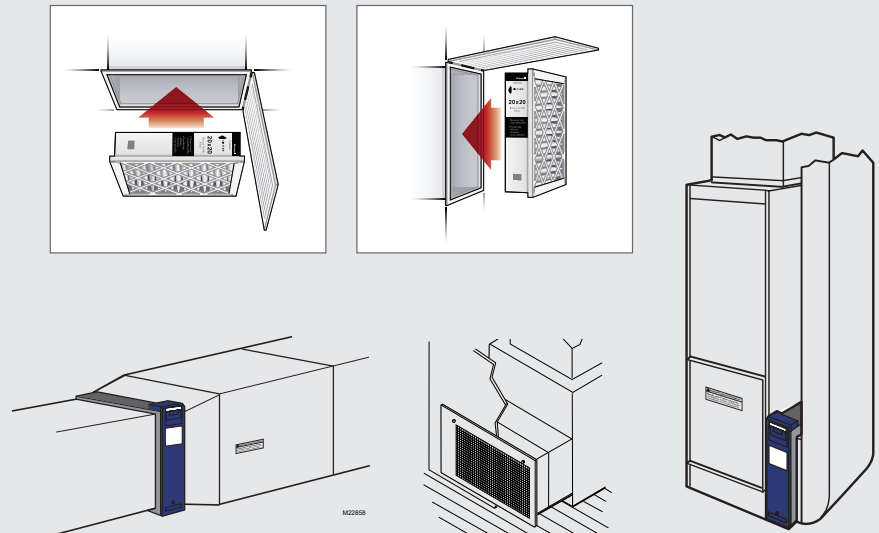
An Electronic Air Cleaner or Media Filter should be installed where maximum air circulation is passing through the HVAC system. Resideo offers air cleaners for return duct or return grill installations. For the most efficient air cleaning, spread airflow evenly across the face of the media, and choose a location that is readily accessible for filter maintenance.



Honeywell Home Air Cleaners and Filters

	Model	Type	OS#	Size	Application	Features and Functions					
						Rated Airflow	Electric Rating	Efficiency (MERV not applicable to electronic air cleaners)	Initial Pressure Drop at Rated Airflow	Replacement Filter/Postfilter	Standard Efficiency Enhancing Postfilter with Anti-Microbial Coating
	F300E	Electronic	F300E1001	16X20	Inline air filtration	1200 CFM	120V	Initial efficiency at 295 FPM 0.3 to 1.0 microns=91% 1.0 to 3.0 microns=98% 3.0 to 10.0 microns=100%	0.05 at 295 0.26 in. w.c.	50000293-001	Yes
			F300E1019	16X25		1400 CFM				50000293-002	
			F300E1027	20X20		1400 CFM				50000293-003	
			F300E1035	20X25		2000 CFM				50000293-004	
	F200E	Media	F200F1620	16X20	Inline air filtration	1200 CFM		MERV 13 at 492 FPM 0.3 to 1.0 microns=63% 1.0 to 3.0 microns=90% 3.0 to 10.0 microns=97%	0.3 in. w.c.	FC200E1003	
			F200F1625	16X25		1400 CFM				FC200E1029	
			F200F2020	20X20		1400 CFM				FC200E1011	
			F200F2025	20X25		2000 CFM				FC200E1037	
	F100F	Media	F100F2044	25X20	Inline air filtration	2000 CFM		MERV 10 at 492 FPM 0.3 to 1.0 microns=25% 1.0 to 3.0 microns=62% 3.0 to 10.0 microns=85%	0.23 in. w.c.	FC100A1037	
			F100F2051	25X22		2000 CFM				FC100A1037	
			F100F1620	16X20		1200 CFM				FC100A1003	
			F100F1625	16X25		1400 CFM				FC100A1029	
			F100F2020	20X20		1400 CFM				FC100A1011	
			F100F2025	20X25		2000 CFM				FC100A1037	



CENTRAL SYSTEM AIR CLEANERS AND FILTERS ARE GENERICALLY CATEGORIZED BY:

Basic Furnace Filters that protect the furnace from bulk dust but do little to remove smaller particles from the air. They come standard with most HVAC systems.

High-Efficiency Particulate Air (HEPA) Filters use deeply folded media to trap a minimum of 99.97% of 0.3 micron particles passing through the filter. Due to air-flow restrictions, HEPA filters do not get installed in a return duct and are typically portable, standalone air-cleaners.

Beware of manufacturers who use terms like “HEPA-style” or “HEPA-like” filters as they may only be “close to” HEPA efficiencies or achieve HEPA efficiencies by circulating air through the filter numerous times.

				Warranty
Maintenance Cycle	Self Regulating Power Supply	Dual Voltage Output Efficiency Optimization	Test Button Operating Verification	
Vacuum prefilter = up to 6 months Wash cells = up to 1 year Replace posfilter = 6 months	Yes	Yes	Yes	5 Year
Replace filter = up to 1 year				5 Year
Replace filter = up to 1 year				5 Year

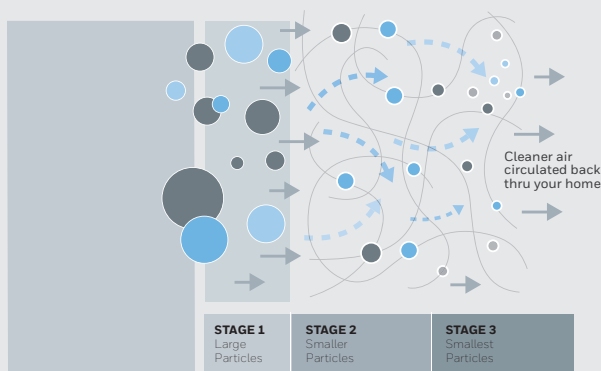

Media Filters filter the air using webs of polypropylene fibers. Resideo offers several media air cleaners and replacement filters, including space and time-saving products like the PopUP™ media replacement filter. The PopUP™ simplifies installation and maintenance with a design that collapses down for space-saving shipping and self-assembles without the need for combs, pleat spacers or end caps.

Electronic Air Cleaners electrically charge and collect airborne particles on a collection grid. The Honeywell Home F300 EAC is up to 30 times more efficient at capturing airborne particles from the air passing through the filter compared to a standard one-inch filter. Its collection grid section offers the most surface area available for charged-particle collection, and it maintains high efficiency over time by increasing voltage based on the amount of particles collected.

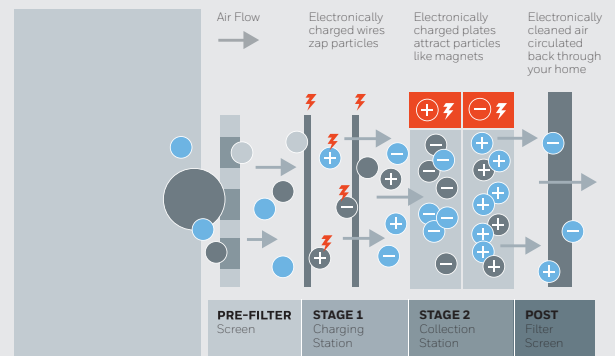



Honeywell Home Replacement Filters





Honeywell Home replacement filters come a wide variety of sizes and styles to fit nearly every application. For long-lasting, high efficiency performance that doesn't compromise airflow, advise your customers to stick with quality Honeywell Home filters.

WHAT IS MERV?

MERV (Minimum Efficiency Reporting Value) is a measure of filter efficiency. The MERV value takes information on the efficiency of the filter against a range of particles from coarse (such as pollens) to fine (such as smoke), then boils it down into one easy-to-understand number. The MERV number can be used to compare filters made by different manufacturers as long as testing conditions, such as air speed, are the same.

Filter Category	Airborne Contaminants Targeted*	Equipment Protection	Air Treatment Level
MERV 1 to 4 Coarse fiber filter	Pollen, airborne dust mite debris, carpet and clothing fibers	Minimal	Minimal
MERV 5 to 8 Standard household filter	The above plus: Mold and plant spores	Basic	Basic
MERV 9 to 12 Premiere household filter	The above plus: Auto emissions, airborne lead dust, airborne coal dust	Basic	Improved
MERV 13 to 16 Hospital grade	The above plus: Certain bacteria, tobacco smoke, sneeze particles, cooking oil	Improved	Superior

* From Cross-Reference and Application Guidelines (Table E-1, ASHRAE Standard 52.2).

	Model	OS#	Size	Fits		Features and Functions				
				F100	F200	Rated Airflow	Efficiency	Initial Pressure Drop at Rated Airflow	Maintenance Cycle	
Cartridge										
	FC200	FC200E1003	16x20x4	x	x	1200 CFM	MERV 13	0.31 in. wc	Replace filter every 6 to 12 months	
		FC200E1029	16x25x4	x	x	1400 CFM				
		FC200E1011	20x20x4	x	x	1400 CFM				
		FC200E1037	20x25x4	x	x	2000 CFM				
	FC100	FC100A1003	16x20x4	x	x	1200 CFM	MERV 10	0.23 in. wc	Replace filter every 6 to 12 months	
		FC100A1029	16x25x4	x	x	1400 CFM				
		FC100A1011	20x20x4	x	x	1400 CFM				
		FC100A1037	20x25x4	x	x	2000 CFM				
		FC100A1052	20x12.5x4		F27FF1032	1000 CFM				
		FC100A1045	21.5x27.5x4		F27F1057	2000 CFM				
PopUP										
	POPUP	POPUP1620	16x20x5	x	x	1200 CFM	MERV 11	0.24 in. wc	Replace filter every 6 to 12 months	
		POPUP1625	16x25x5	x	x	1400 CFM				
		POPUP2020	20x20x5	x	x	1400 CFM				
		POPUP2025	20x25x5	x	x	2000 CFM				
		POPUP2200	20x25x5			2000 CFM				
		POPUP2400	16x28x5			2000 CFM				
Return Grill										
	FC40	FC40R1094	12x12x3	Replaces 1 inch filters in filter grills.		500 CFM	MERV 10	0.12 in. wc at 2 cfm per sq. in.	Replace filter every 6 to 12 months	
		FC40R1037	12x24x3			1000 CFM				
		FC40R1102	14x14x3			680 CFM				
		FC40R1110	14x20x3			972 CFM				
		FC40R1128	14x24x3			1167 CFM				
		FC40R1045	14x25x3			1215 CFM				
		FC40R1169	14x30x3			1458 CFM				
		FC40R1052	16x20x3			1111 CFM				
		FC40R1060	16x25x3			1389 CFM				
		FC40R1136	18x24x3			1500 CFM				
		FC40R1185	18x18x3			1125 CFM				
		FC40R1830	18x30x3			1875 CFM				
		FC40R1003	20x20x3			1389 CFM				
		FC40R1144	20x24x3			1667 CFM				
		FC40R1011	20x25x3			1736 CFM				
		FC40R1029	20x30x3			2083 CFM				
FC40R1078	24x24x3	2000 CFM								
FC40R1177	24x30x3	2500 CFM								
	FC313	FC313R2036*	20X36X3	Replaces 1 inch filters in filter grills.		1800 CFM	MERV 13	.177 in. w.c.	Replace filter every 6 to 12 months	
		FC313R2020*	20X20X3			1150 CFM				
		FC313R2024*	20X24X3			1450 CFM				
		FC313R2025*	20X25X3			1450 CFM				
		FC313R2030*	20X30X3			1800 CFM				
		FC313R1424*	14X24X3			950 CFM				
		FC313R1414*	14X14X3			500 CFM				
FC313R1818*	18X18X3	950 CFM								

*Title 24-compliant model



Ventilating For Today's Homes

Modern building construction and codes require modern ventilation. Honeywell Home whole home ventilation systems efficiently bring in fresher air while driving out stale air. Highly versatile, they're ideal for both new construction and retrofit projects.

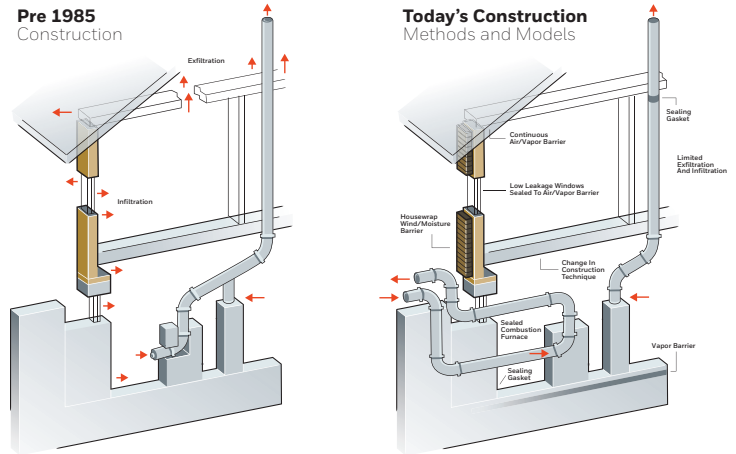

TYPICAL INSTALLATIONS

Honeywell Home Energy and Heat Recovery Ventilation (ERV and HRV) systems are designed for installation versatility and integrate with existing HVAC equipment or can function as a standalone system.

For ventilation installation, the air duct and damper must be installed between the outdoors and the return side of the HVAC system. The ventilator can be controlled in different ways. A standalone control can be installed in the same room as the ventilator, or control can be handled through an IAQ thermostat.

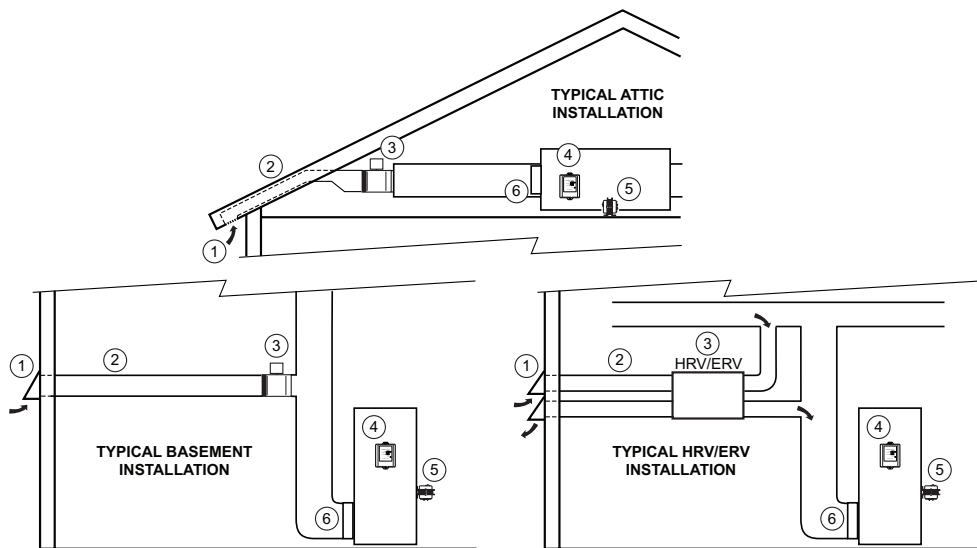

M19993B

ASHRAE STANDARD 62.2 FOR VENTILATION

ASHRAE Standard 62.2 “defines the roles of and minimum requirement for mechanical and natural ventilation systems and the building envelope intended to provide acceptable indoor air quality (IAQ) in low-rise residential buildings.” (ASHRAE 62.2)

VENTILATION FOR ASHRAE 62.2 MAY BE MET BY ANY OF THE FOLLOWING:

Exhaust Ventilation

- Negative pressure draws fresh air from an unknown source
- Fresher air may come through structure, garage, etc.
- Must have make-up air for combustion products

Supply Ventilation

- Positive pressure pushes stale air out of the home
- Fresher air enters home from a known source
- Fresher air can be conditioned before entering the living space
- Stale air may pass through the structure

Balanced Ventilation

- Net zero pressure differential in home
- Outdoor air comes from a known source
- Fresh air can be conditioned before entering the living space

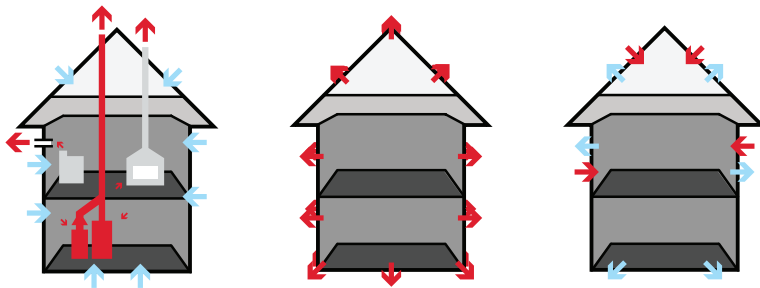

SIZING A VENTILATION SYSTEM ACCORDING TO ASHRAE 62.2:

According to ASHRAE Standard 62.2, the required amount of outdoor air to be continuously introduced into the home is:

$$Q_{fan} = 0.01A_{floor} + 7.5(N_{br} + 1)$$

Where:

Q_{fan} = fan flow rate, CFM

A_{floor} = floor area, ft²

N_{br} = Number of bedrooms;
not to be less than 1

Floor Area (ft ²)	Bedrooms				
	0-1	2-3	4-5	6-7	>7
< 1500	30	45	60	75	90
1501 - 3000	45	60	75	90	105
3001 - 4500	60	75	90	105	120
4501 - 6000	75	90	105	120	135
6001 - 7500	90	105	120	135	150
> 7500	105	120	135	150	165

There are also provisions in ASHRAE 62.2 that allow ventilation to be delivered on a non-continuous basis, providing maximum output at a fraction of the time. ENERGY STAR, Environments for Living (EFL), and many ventilation codes in the US and Canada require homes to install ventilation per the ASHRAE 62.2 Standard.

All Resideo ventilation controls have built in programming to ventilate according to ASHRAE 62.2, making it easy to meet this code and pass inspection.





Helping Homeowners

Educating homeowners on the need to exchange air will help them understand that whole home ventilation is far more effective than portable units. Whole home ventilation is quieter, has a higher capacity, and is more cost-effective.

Signs That A House Needs Ventilation

- Excessive dust (house under negative pressure)
- Overly humid
- Lingering odors from cooking



	Model	Type	Supply, Exhaust, or Balanced	Dimensions (H X W X L) Inches/mm	CFM	Duct Connections	Intuitive balancing via two variable speed motors and a speed control	Defrost Control	Terminals to turn on furnace blower fan
	VNT5070H1000	HRV (Heat Recovery Ventilator)	Balanced	21 X 20 X 14-1/2 (533 X 507 X 368)	70	4 round duct collars	x	x	x
	VNT5070E1000	ERV (Energy Recovery Ventilator)	Balanced	21 X 20 X 14-1/2 (533 X 507 X 368)	70	4 round duct collars	x	x	x
	VNT5150H1000	HRV (Heat Recovery Ventilator)	Balanced	22-1/2 X 11-1/2 X 29-1/2 (572 X 295 X 749)	150	4 round duct collars	x	x	x
	VNT5150E1000	ERV (Energy Recovery Ventilator)	Balanced	22-1/2 X 11-1/2 X 29-1/2 (572 X 295 X 749)	150	4 round duct collars	x	x	x
	VNT5200H1000	HRV (Heat Recovery Ventilator)	Balanced	22-1/2 X 16-1/2 X 29-1/2 (572 X 422 X 749)	200	4 round duct collars	x	x	x
	VNT5200E1000	ERV (Energy Recovery Ventilator)	Balanced	22-1/2 X 16-1/2 X 29-1/2 (572 X 422 X 749)	200	4 round duct collars	x	x	x
	Y8150A1017 (kit with EARD6TZ & W8150A1001 control)	Fresh air damper	Supply	EARD6TZ = 6" (153mm) diameter X 8" (203mm)	50-160	6" damper crimped on one end	N/A		x
	W8150A1001 (control only)	Control only	Control only	5-3/4 X 4-3/16 X 1-1/4 (146 X 106 X 32)	N/A	N/A	N/A		x
	HVC0001 (control only)	Exhaust fan control	Control only for exhaust fan		N/A	N/A	N/A		N/A

Resideo Ventilation

Help homeowners understand their options for the best balance of energy savings and ventilation control.

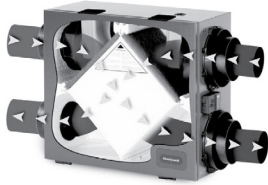

Honeywell Home Energy Recovery Ventilators (ERV) and Heat Recovery Ventilators (HRV) efficiently bring fresher outdoor air into the home by recovering up to 70% of the exhausted air’s sensible heat as well as some latent heat. As stale air is exhausted outside through the ventilator, heat is transferred from one air stream to the other as the air passes through the opposite sides of the heat transfer core. ERVs also reduce the amount of humidity, making them a great choice for southern climates. For colder climates, HRV and ERV models also offer core defrost as an option.



Y8150 Fresh Air Ventilation Systems provide an economical way to work with the existing system fan to deliver outside air to the home. Intuitive, ‘set it and forget it’ programming keeps your customers from adjusting the controls, helping to reduce callbacks. With an overall low total installed cost, it is easy to wire in any orientation, requiring only the included damper, transformer and control.

Replacement Filter	Mounting	Warranty
50063805-003	Wall Mount Bracket	5 Years
50063805-003	Wall Mount Bracket	5 Years
50053952-005	Adjustable hanging straps	5 Years
50053952-005	Adjustable hanging straps	5 Years
50053952-006	Adjustable hanging straps	5 Years
50053952-006	Adjustable hanging straps	5 Years
N/A	6" rigid or flex duct connection	5 Years
N/A	N/A	5 Years
N/A	N/A	5 Years

HONEYWELL HOME VENTILATION CONTROLS



Digital Bath Fan Control

This economical single-speed control allows you to program your ventilation and fan settings - increasing comfort, convenience and energy efficiency.



Prestige® IAQ

This premium solution offers advanced control for more robust HVAC and IAQ systems, such as those with ventilation. RedLINK™ accessories, including the gateway for access to the Total Connect Comfort app, help provide total comfort and convenience.



UV Treatment Systems Can Help Control Mold And Bacteria Growth

Honeywell Home UV systems installed in forced air heating and cooling systems use proven ultraviolet irradiation in the duct system to reduce airborne or surface microorganism contaminants like viruses, bacteria and mold. They provide an effective, out-of-sight way to improve indoor air quality. The Honeywell Home UV Air Purifier with AirBRIGHT™ Odor Absorption also reduced airborne odors and toxic chemical vapors inside the duct system.

TYPICAL INSTALLATIONS

UV Air Treatment models are installed on the return duct of the HVAC equipment. The UV100 single lamp unit has moderate efficiency. The UV2400 unit and UV100 Dual lamp unit have high efficiency performance against airborne bacteria in return air applications. The UV Coil Irradiation models are installed in the supply side air duct to illuminate the A-Coil section of the air conditioning equipment. It reduces mold growth and spores on duct surfaces, coils and drip pans.

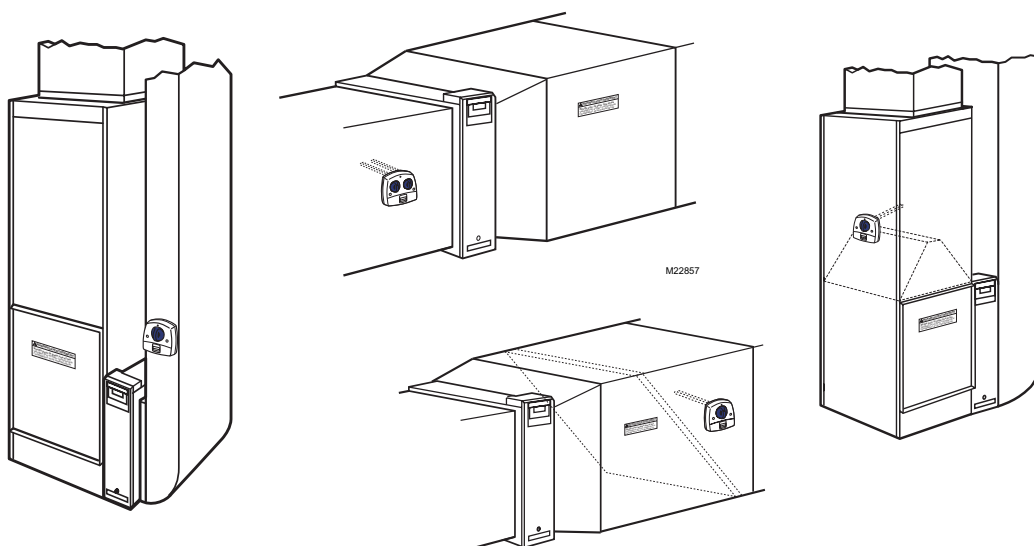

How Does UV Technology Work?

Ultraviolet is a high-energy light invisible to the naked eye, which makes up three bands of the light spectrum (UV-A, UV-B and UV-C). UV-C is the wavelength of light utilized by Honeywell Home UV Treatment Systems to scramble the DNA coding of bacteria and germs, rendering the pathogen nonviable, unable to reproduce or infect. This is possible because the pathogen's nucleic acid absorbs light energy from 230nm – 290nm, which is within the range of UV-C light.

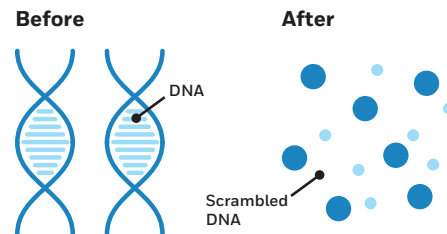
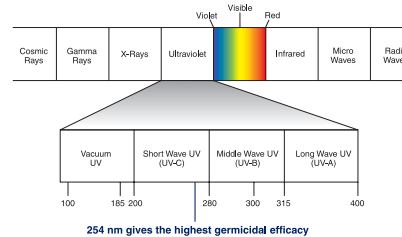

The dosage required is a measurement of light intensity and exposure time, and differs for each type of pathogen. Many additional factors determine the effectiveness of UV-C irradiation:

Lamp Intensity

Higher for airborne pathogens since exposure time is limited.

Lamp Life

Industry standard for effective UV-C emission is 8,000 hours. Resideo uses soft lamps that are chemically coated to minimize mercury buildup on lamp walls, increasing effective operation to 10,000 hours.

Fan Speed

Slower fan speeds increase the time a pathogen is exposed to UV-C. Honeywell Home models were tested at 2,000 cfm in a 12" x 25" duct, representative of real-life applications.

Lamp Position

Three feet of open space both before and after the lamps wherever possible provides the most effective UV-C dosage.

Temperature

Cooler temperatures make it more difficult for UV-C to penetrate the glass lamp wall, which is why UV Air Treatment Systems should be installed on the return duct to avoid exposure to chilled air during air conditioning season.

Maintenance

Dust settling on the outside of lamps reduces the intensity of light, which reduces efficiency of the system. Quarterly lamp cleaning with a soft damp cloth ensure proper UV-C output.

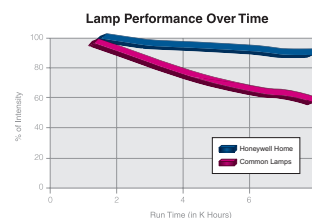





Served By History

UV treatment solutions are fairly new to the HVAC industry, but have been utilized for nearly a century. UV can be installed in new construction, retrofit and add-on projects. The following pages highlight the types of Honeywell Home UV Treatment systems available and the ideal application for each.

Signs That A Home Needs A UV Treatment System

- Humid climate
- Closed windows and dry climate in winter
- Concern for maintaining energy efficiency
- Frequent cleaning of air conditioning ductwork



	Model	Air Treatment	Surface Treatment	Safety is Built Into Sealed Design with Interlocks	Check Operation Safely	Kill Rate*	Voltage	AirBRIGHT Odor Absorption
	UV2400U5000	x	x	x	Sight glass included**	99% for surface and 90% for air treatment	24 VAC	X (included)
	UV2400U1000	x	x	x	Sight glass included**	99% for surface and 90% for air treatment	24 VAC	Sold separate (UV2400XPC01)
	UV100E2009	x		x	Light pipe in handle	87% Air Treatment	120 VAC	
	UV100E1043	x		x	Light pipe in handle	70% Air Treatment	120 VAC	
	UV100A1059	x	x	x	Light pipe in handle	75% Air Treatment 99.9% Surface Treatment	120 VAC	

* Air treatment test performed shows a single pass kill rate of *Serratia marcescens* bacteria in a clean metal 12" x 25" duct at an airflow of 2,000 cfm using new lamps. Surface treatment test performed in a test duct showed a 3-log (99.9%) reduction in colony-forming *Aspergillus niger* mold spores when surface was irradiated at a distance of 18" for three hours in still air using new lamps.

** Viewing window included, but installed separately

Honeywell Home UV Treatment Systems

Patented SmartLamp technology is used in some UV Treatment Systems to provide additional equipment protection, extended lamp life, and maintenance indications to reduce callbacks.



UV Air Treatment System
Dual Lamp Return Air



UV Surface Treatment
System Coil Irradiation

Honeywell Home UV Air Treatment Systems are installed in the return duct to irradiate airborne germs. Because these germs are airborne, UV Air Treatment systems provide higher intensity UV-C dosages to help disinfect and prevent the spread of germs in the duct system.

Duct Board Adaptor	Warranty (excludes bulb)	Replacement Bulb
UV2400XDBA1	5 Year	UV2400XLAM1/U
UV2400XDBA1	5 Year	UV2400XLAM1/U
	5 Year	UC100E1006 (Two bulbs needed)
	5 Year	UC18W1004
	5 Year	UC36W1006



24 UV Air Purifier with AirBRIGHT Odor Absorption is installed in the ductwork of your HVAC system to reduce airborne odors, toxic chemical vapors, germs and mold. The air cleaner's UV light and activated carbon cells reduce volatile organic compounds (VOCs) in the duct system .



Replacement Bulbs literally make replacement a snap, giving you a quick source for recurring revenue.

Achieve Ideal Humidification

Homeowners don't notice humidity levels — unless there's too much or not enough. While air cleaners, ventilation and UV treatment systems keep indoor air clean, proper humidification is needed to control relative humidity (RH) levels. Too much humidity is uncomfortable and can lead to mold and mildew. Too little humidity can cause dry skin, and damage the home's wood furnishings.

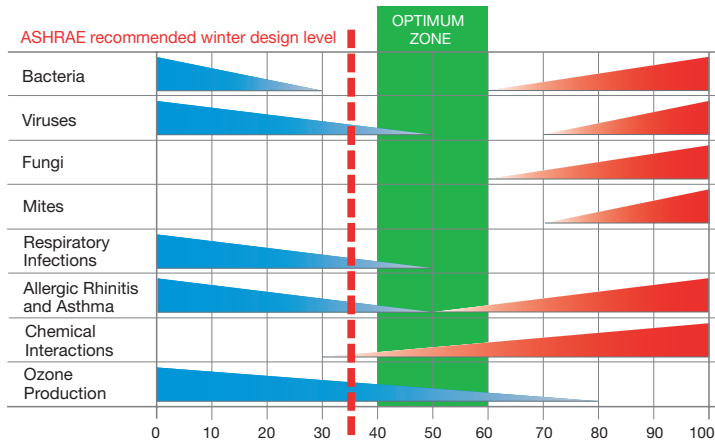

TYPICAL INSTALLATIONS

Flow-through humidifiers are installed on either the supply plenum or return duct, based on the specific application. Steam humidifiers are mounted directly to the ductwork or remotely to provide humidity on demand. Controlled by a humidistat or IAQ thermostat, whole home humidifiers are designed to introduce moisture directly into the duct's airstream to evenly distribute humidity throughout the home.

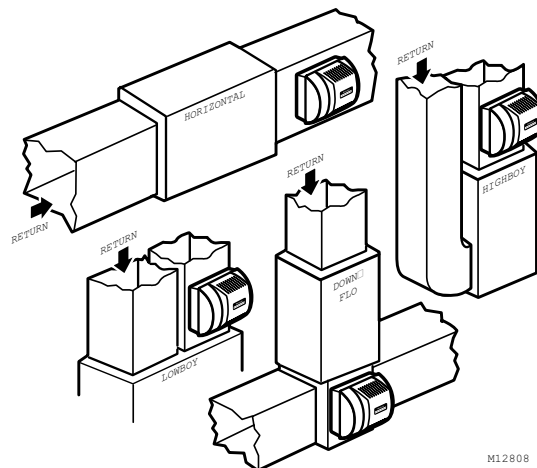
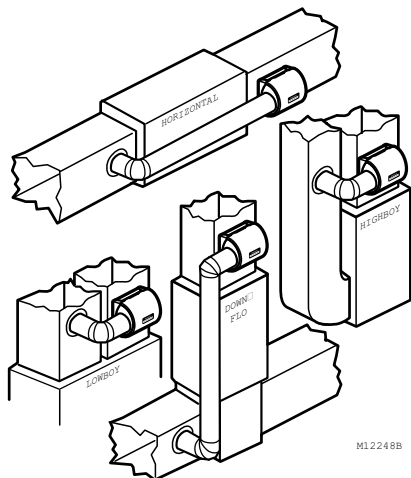

Understanding Humidity

Humidifiers operate by the principle that vapor is created when warm dry air is blown over a moist pad (flow-through units), or through steam from evaporated heated water (steam units). As the vapor or steam circulates, the relative humidity rises in the living areas.

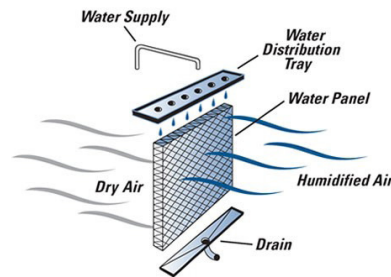

Humidified Air

This image shows the humidifying process used by evaporative flow through humidifiers.

Relative Humidity

The amount of moisture present at a given temperature versus the maximum amount of humidity the air is capable of holding at that same temperature. If relative humidity is 35% at a given temperature, the air is 35% saturated with water.

Dew Point

The temperature at which moisture in the air will condense into water droplets. To prevent condensation, dew point must be below the temperature of the coldest surface in the house. As the temperature of home surfaces (If the inside surface of a window drops below dew point, condensation forms.)

Infiltration

Cold air holds less moisture than warm air. Without adequate humidification, the natural infiltration of cold, dry, outside air into a home will lower the indoor relative humidity far below the comfort level. During the winter months, indoor relative humidity can drop below 6% as a result. Too little humidity can damage wooden assets in the home, including hardwood floors, staircases, furniture and musical instruments.

Identifying Whole Home Humidification Opportunities

Homes with lots of wood furnishings, paintings or musical instruments

Proper humidity reduces risk of damage to home's woodwork, flooring, musical instruments and paintings.

Conversation starters

- Did you know many wood flooring companies require a centrally ducted humidifier for the floor warranty to be valid?
- Did you know that without proper levels of humidity, wood floors can crack or form gaps and warp?
- Did you know your paintings and musical instruments can crack or go out of tune without humidity?

Honeywell Home Whole Home Humidifiers

	Model	Type	Dimensions (L X W X H) Inches/mm	Capacity in Gallons Per Day	Included Control
	HM750A1000	Steam	10" X 7" X 18" (254 X 178 X 457)	Up to 11 GPD at 120V, Up to 22 GPD at 240V	HumidiPRO® H6062 Digital Humidity Control
	HE365A1000	Evaporative Fan	10.25 X 14 X 15 (260 X 356 X 381)	Up to 18 GPD	H8908 Humidistat
	HE300A1005	Evaporative Fan	10.3 X 15.5 X 16.8 (262 X 394 X 427)	Up to 18 GPD	HumidiPRO® H6062 Digital Humidity Control
	HE250A1005	Evaporative Bypass (Advanced)	10.1 X 15 X 17.15 (257 X 381 X 436)	Up to 17 GPD	HumidiPRO® H6062 Digital Humidity Control
	HE150A1005		10.1 X 14.5 X 14 (257 X 368 X 356)	Up to 12 GPD	HumidiPRO® H6062 Digital Humidity Control
	HE200A1000	Evaporative Bypass (Basic)	9.4 X 18.30 X 17.11 (242 X 465 X 434)	Up to 17 GPD	HumidiPRO® H6062 Digital Humidity Control
	HE100A1000		9.47 X 15.16 X 16.57 (240 X 385 X 421)	Up to 12 GPD	HumidiPRO® H6062 Digital Humidity Control
	HE205A1000	Evaporative Bypass (Basic)	9.4 X 18.30 X 17.11 (242 X 465 X 434)	Up to 17 GPD	H8908A mechanical humidity control
	HE105A1000		9.47 X 15.16 X 16.57 (240 X 385 X 421)	Up to 12 GPD	H8908A mechanical humidity control



Honeywell Home evaporative bypass humidifiers are quiet and highly efficient, delivering the same amount of humidity as competitive models. With advanced models, homeowners also save energy because the automatic damper opens and closes only when humidity is needed rather than constantly cycling air through the bypass. Meet the needs of any home – models are available to supply 12, 17 and 18 gallons per day.

Honeywell Home Whole Home Humidifiers

LEDs for Status & Troubleshooting	Damper (Bypass Models Only)	Terminals to turn on system fan, only run with a call for heat, and air-proving switch?	Replacement Pad or Cylinder	Mounting Options
Yes	N/A	Turn on system fan & and air-proving switch.	HM750ACYL Cylinder	Duct mount or remote mount with included remote mount kit.
No	N/A	No	HC26A1008 pad without Agion coating HC26E1004 pad with Agion coating	Supply or return duct
Yes	N/A	Yes	HC26A1008 pad without Agion coating HC26E1004 pad with Agion coating	Supply or return duct
Yes	Yes, automatic	Yes	HC26A1008 pad without Agion coating HC26E1004 pad with Agion coating	Humidifier on Supply duct and bypass to return duct or vice-versa
Yes	Yes, automatic	Yes	HC22A1007 pad without Agion coating HC22E1003 pad with Agion coating x	
No	Yes, manual	No	HC26A1008 pad without Agion coating HC26E1004 pad with Agion coating	Humidifier on Supply duct and bypass to return duct or vice-versa
No	Yes, manual	No	HC22A1007 pad without Agion coating HC22E1003 pad with Agion coating	
No	Yes, manual	No	HC26A1008 pad without Agion coating HC26E1004 pad with Agion coating	Humidifier on Supply duct and bypass to return duct or vice-versa
No	Yes, manual	No	HC22A1007 pad without Agion coating HC22E1003 pad with Agion coating	

HONEYWELL HOME HUMIDITY CONTROLS

From all-in-one controls to the basics, Resideo lets you provide homeowners options:



Prestige® IAQ Thermostat with RedLINK® Technology

The Prestige® IAQ offers the robust RedLINK® wireless capabilities you trust to deliver a total solution – with a smaller, sleeker profile for design-conscious residential and light commercial end users.



H6062 HumidiPRO® Control

Easy-to-use digital control provides manual and automatic humidification or dehumidification for central heating and air conditioning systems. HumidiPRO™ will automatically adjust settings for changes in outdoor temperature to ensure no condensation will appear in the home.



Manual Humidistats

Meet basic needs with a variety of simple controls that can be installed near the humidifier, or in the living space.



Whole Home Dehumidification

Nothing makes homeowners happy like lowering humidity levels on hot, sticky days — especially if you can save them energy at the same time. A Honeywell Home Whole Home Dehumidification System not only improves comfort by lowering the humidity, but it also reduces air conditioning costs because the air conditioner won't have to work as hard.

DEHUMIDIFICATION WORKS WONDERS

Whole home dehumidifiers remove moisture (latent heat) from the air, allowing the air conditioner to focus on removing the heat sensed by the thermostat (sensible heat). This lets the air conditioner operate more efficiently and achieve its designed SEER rating.

Honeywell Home Whole Home Dehumidifiers can also help when lower humidity is desired but cooling isn't needed, such as morning and evenings or during a rainstorm. Because the moisture is removed throughout the home by the dehumidifier, the air conditioner runs less.

TYPICAL INSTALLATIONS

For the ideal installation, the whole-house dehumidifier should draw air from the central part of the home and return it to isolated areas, such as bedrooms, the den, utility rooms, or family room. The unit can draw from the return and dump into the supply if needed, and it can be installed in a variety of locations to meet application needs. The control should be installed where it can accurately sense relative humidity. Honeywell Home Whole Home Dehumidification Systems can also be used as a standalone solution to remove moisture from problem areas.

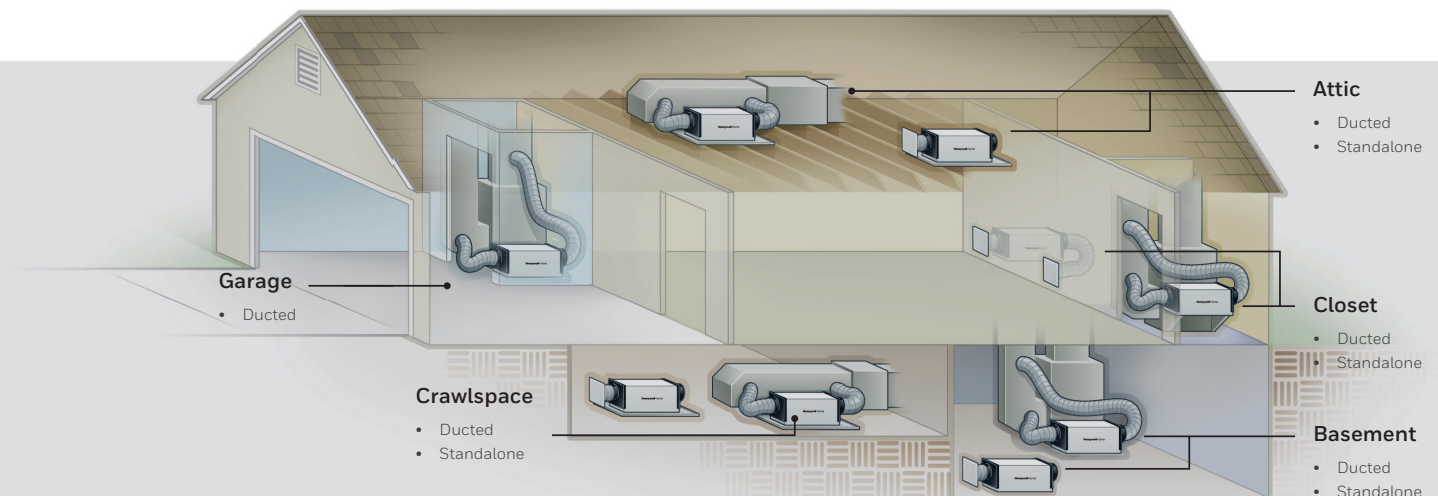

*Refer to Instruction Manual for installation guidelines.

IDEAL OPTIONS

Resideo offers a full line-up of whole-house dehumidifiers to meet the needs of any residential application. Sizes are available to cover homes from small condos to large residences. And whether the application requires installing a whole-house unit in a tight utility closet, crawl space or an unfinished basement, you'll find installation a breeze.



A key feature that homeowners really appreciate: Honeywell Home DR90 and DR120 dehumidifiers are Energy STAR® rated.

How Can Dehumidification Help Control Indoor Air Quality?

ASHRAE industry standards cite ideal indoor relative humidity levels below 51% to deter unwanted conditions and boost overall comfort. Any geographic region with summer dewpoint averages above 55° F are potential growth regions for whole-house dehumidifiers. Whole-house dehumidifiers are designed to provide three key components to better indoor air — fresh air ventilation, particulate filtration and humidity control.

AVERAGE SUMMER DEW POINTS

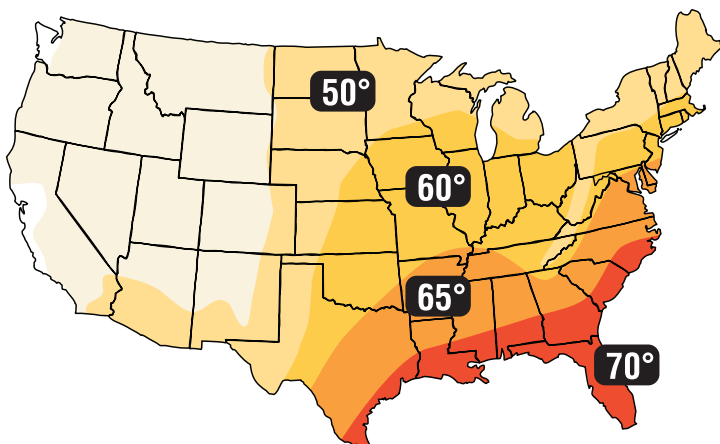

Not Just New Construction

Retrofit dehumidification sales have been on the rise in recent years, making it the HVAC industry's hot-topic comfort solution. Coupling the energy savings message with the ventilation control included with the DR90 and DR120 will help ensure the home is provided with high-capacity, cost-effective dehumidification that will help safeguard the home from excess moisture while improving home comfort.

Signs That A Home Needs Dehumidification



- Low set point on thermostat in hot climate
- Condensation on walls and windows
- Humidity levels above 60%
- Uncomfortable sleeping conditions
- Portable dehumidifiers

Honeywell Home Whole Home Dehumidifiers

Unlike portable, single-room dehumidifiers that only remove moisture in the rooms where they're located, Honeywell Home Whole Home Dehumidification Systems offer a whole house solution that's more effective and can be less expensive than putting multiple single-room units in a home. Plus, Whole Home models improve comfort and eliminate the need for maintenance (such as emptying collection buckets) – all while using less energy compared to most portable dehumidifiers.

Three models are available – DR65, DR90 and DR120 – so it's easy to find the right-sized unit for any application. Control with a basic dehumidistat or through a control such as Digital Control Humidistat, Honeywell Home Whole Home models also include a MERV 11 air filter to help bring fresh, filtered air into the home.



	Model	OS#	Specifications				Control Options	Features	
			Pints per Day	Energy Performance	Energy Star Rated	Refrigerant		Controls	Filter Efficiency
	DR65	DR65A3000	65	2.22 liters (4.7 pints) per kilowatt hour (KWH)		R-410A, 15 oz.	Built-in control, Prestige® IAQ, T10 Pro Smart, VisionPRO Smart, VisionPRO RedLINK®, HumidiPRO®	MERV11	
	DR90	DR90A3000	90	2.9 liters (6.1 pints) per kilowatt hour (KWH)	x	R-410A	Prestige® IAQ, T10 Pro Smart, VisionPRO Smart, VisionPRO RedLINK®, HumidiPRO®	MERV 11	x
	DR120	DR120A3000	120	2.9 liters (6.1 pints) per kilowatt hour (KWH)	x	R-410A, 30 oz.	Prestige® IAQ, T10 Pro Smart, VisionPRO Smart, VisionPRO RedLINK®, HumidiPRO®	MERV 11	x

Home Size (square ft [m])	Dehumidifier Capacity Required to Maintain Desired Indoor RH*		
	60% RH Indoor (pints/day)	50% RH Indoor (pints/day)	40% RH Indoor (pints/day)
2080 (193.2)	49–54	55–58	71–78
2600 (241.5)	61–68	65–72	90–97
3120 (289.9)	75–82	79–86	95–110

*Based on extreme climates where outdoor humidity is 70-90% RH. For less extreme climates, larger homes can be adequately served with less capacity. Actual requirements may vary.

HONEYWELL HOME DEHUMIDIFICATION CONTROLS



Redesigned Prestige® IAQ and Prestige 2.0

- RedLINK® technology and accessories
- Sliding scale shows actual and desired humidity levels
- Customizable service reminders
- Can control humidifier, dehumidifier and ventilator



T10 Pro Smart with RedLINK® Room Sensor

- Control humidification, dehumidification, or ventilation from thermostat or app
- Energy savings through time-based scheduling and geofencing
- Add on RedLINK® Room Sensors to extend reach of thermostat beyond the hallway sensors



HumidiPRO® Digital Humidity Control

- Manages dehumidification or humidification
- Simple installation, programming and operation
- Wired outdoor sensor included



VisionPRO® 8000 with RedLINK® Technology

- All-in-one control in the living space
- RedLINK® technology and accessories
- Smart Schedule programs in seconds
- Optional THM5421R1021 EIM eliminates wiring at the thermostat and controls of heating, cooling, and IAQ equipment

No One Backs Your Business Like Resideo

ONLINE RESOURCES

www.resideo.com/pro

- New Product Information and Training
- Interactive Product Demos
- Full Line of Resideo Products
- Product Photography, Sales/Technical Literature

customer.resideo.com

- Online Ordering and Pricing
- Distributor Order Status and Shipment Tracking
- Private Label Program
- Warranty Returns
- Literature/Image Search
- Training

www.resideo.com/literature

- Sales and Technical Literature
- Postcards, Posters and Other
- Promotional Materials

YOUR LOCAL RESIDEO CONTRACTOR DEVELOPMENT SPECIALIST

Name: _____

Phone: _____

Email: _____

SUPPORT RESOURCES

Homeowner and Dealer General Technical Support

- www.resideo.com

Dealers and Distributors Product Specific Technical Support

- Humidification, Ventilation and Dehumidification Support 1-800-468-1502

Pro PERKS Support

- properks@resideo.com 1-800-919-4835
- Have your Pro PERKS membership number ready

Order Support

- Customer Care Support 855-381-3530 (Distributors Only)
- Order Entry 1-888-793-8193
- Order Status, Pricing and Availability 1-888-793-8193



Resideo Technologies, Inc.

1985 Douglas Drive North
Golden Valley, MN 55422
resideo.com

50-8767 | VN | 05/21
© 2021 Resideo Technologies, Inc. This product is manufactured by Resideo and its affiliates. The Honeywell Home trademark is used under license from Honeywell International, Inc. All rights reserved.