

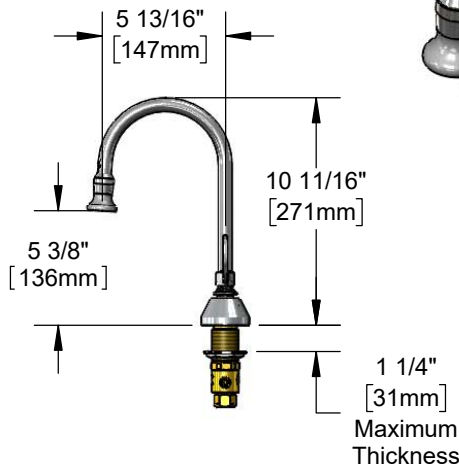

Architect/Engineering Specifications:

8" concealed deck mount mixing faucet with forged brass body, 5 13/16" swivel/rigid gooseneck with 2.2 GPM rosespray outlet, compression cartridges with spring checks, 4" wrist action handles, chrome plated escutcheons and 1/2" NPT male inlets with coupling nuts. Certified to ASME A112.18.1/CSA B125.1, NSF 61-Section 9 and NSF 372. Meets ADA ANSI/ICC A117.1 requirements.

Job Name _____
 Model Specified _____ Quantity _____
 Variations Specified _____
 Date _____

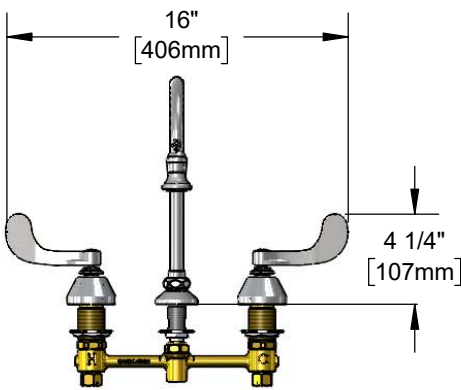

Features & Benefits:

- 8" EasyInstall concealed deck mount mixing faucet w/ forged brass body
- 5 13/16" swivel/rigid gooseneck
- Lock washer provided for rigid application
- 2.2 GPM rosespray outlet, Series 1
- Quarter-turn Eterna compression cartridges w/ spring checks to prevent cross flow of water
- 4" wrist action handles w/ color coded indexes
- 1/2" NPT male inlets w/ coupling nuts
- Material: Forged brass body, polished chrome plated brass tubular spout and chrome plated metal handles & escutcheons

Product Compliance:

- ASME A112.18.1 / CSA B125.1
- NSF 61 - Section 9
- NSF 372 (Low Lead Content)
- ANSI A117.1 (ADA)



Warranty: One Year (Limited)

Performance Data:

- Pressure: 20 - 125 psi [1.38 - 8.62 bar]
- Temperature: 40 °F - 140 °F [44.44 °C - 60 °C]
- Flow Rate: 2.2 GPM [8.33 L/min] @ 60 psi [4.14 bar]



ADA Compliant

Optional Outlets (Series 1 / VR Series 6)

GPM	Aerated	Non-Aerated (Laminar)	VR Aerated	VR Non-Aerated (VR Laminar)
0.35	N/A	<input type="checkbox"/> B-0199-01-N035	N/A	<input type="checkbox"/> B-0199-06-N035
0.5	N/A	<input type="checkbox"/> B-0199-01-N05	N/A	<input type="checkbox"/> B-0199-06-N05
1.0	<input type="checkbox"/> B-0199-01-F10	N/A	<input type="checkbox"/> B-0199-06-F10	N/A
1.2	<input type="checkbox"/> B-0199-01-F12	<input type="checkbox"/> B-0199-01-LF12	<input type="checkbox"/> B-0199-06-F12	<input type="checkbox"/> B-0199-06-LF12
1.5	<input type="checkbox"/> B-0199-01-WS	<input type="checkbox"/> B-0199-29	<input type="checkbox"/> B-0199-06-WS	<input type="checkbox"/> B-0199-29VR
2.2	<input type="checkbox"/> B-0199-01	<input type="checkbox"/> B-0199-21	<input type="checkbox"/> B-0199-06	<input type="checkbox"/> B-0199-21-VRF

Optional Handles

- 4" Wrist Action (Standard)
- Lever
- 4-Arm

Optional Cartridges

- Quarter-Turn Cerama w/ Check Valve
- Quarter-Turn Eterna w/ Spring Check (Standard)
- Push Button Metering
- Pivot Action Metering
- Wrist Action Metering

