

Pocket Guide

Viega MegaPress® Systems

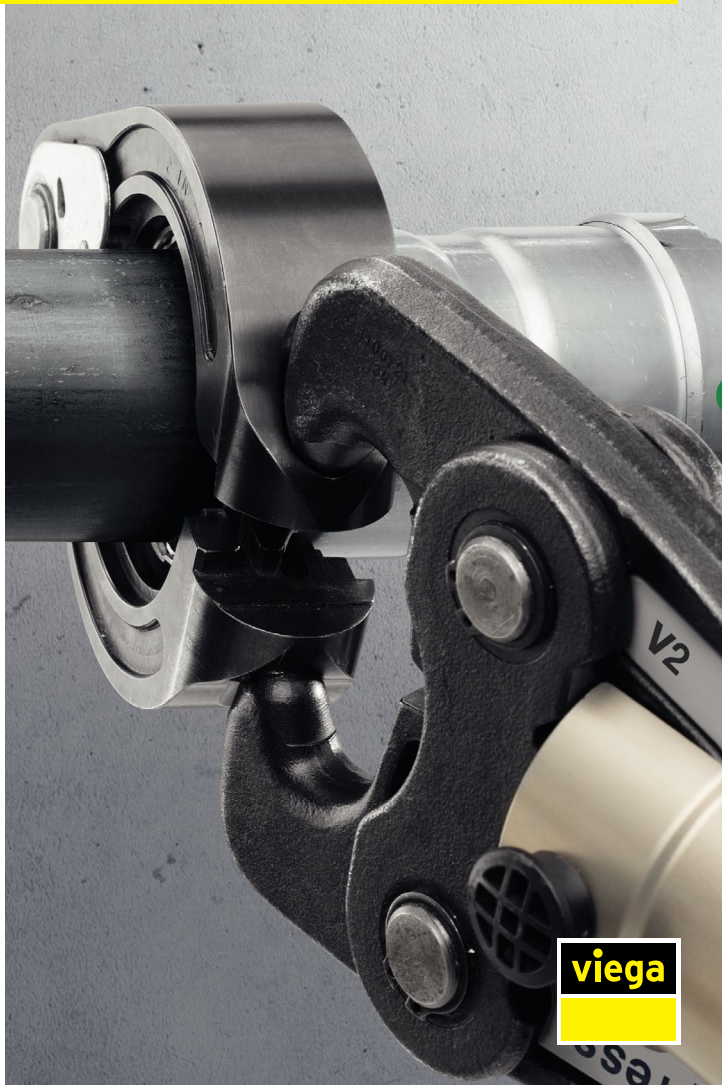

Viega.

Connected in quality.

Building on Tradition

Founded 120 years ago, Viega is a privately owned, international group of companies. In the United States, Canada, Mexico, and Latin America, Viega specializes in plumbing, heating, and pipe joining technologies. The values of Viega's founder, Franz-Anselm Viegener, are just as present today as they were when he started the company in 1899. Courage, passion, and innovative spirit are still the basics of Viega's foundation.

At Viega, safety is priority.

Safe, certain, and secure, Viega fittings are designed for peace of mind

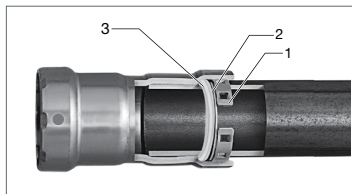

1. In MegaPress, MegaPress FKM, and MegaPressG fittings, the 420 stainless steel grip ring's teeth cut into the pipe and lock the fitting securely in place.

2. For ½" to 2" fittings, a 304 stainless steel separator ring protects the sealing element from damage by creating a positive physical separation during installation. For 2½" to 4" fittings, a PBT (Polybutylene Terephthalate) separator ring for MegaPress and MegaPress FKM fittings and a graphite separator ring for MegaPressG protects the sealing element.
3. Viega offers three different sealing elements to suit virtually any application: EPDM, HNBR, and FKM. They all ensure water-tight or air-tight connections.

In all MegaPress fittings, Viega's unique Smart Connect technology helps installers ensure that they have pressed all connections.



A green dot on a Viega MegaPress fitting indicates Smart Connect® technology with an EPDM sealing element. A white dot on a Viega MegaPress FKM fitting indicates Smart Connect technology with an FKM sealing element. A yellow dot on a Viega MegaPressG fitting indicates Smart Connect technology with an HNBR sealing element. For a current list of applications, please visit www.viega.us/applications.

Introduction	4
MegaPress, MegaPress FKM, and MegaPressG Systems	4
System Data	6
Viega MegaPress Fittings	6
Viega MegaPress FKM Fittings	7
Viega MegaPressG Fittings	8
Tech Data	9
Viega MegaPress 3-Piece Ball Valve, Model 4875.8	9
Viega MegaPress FKM 3-Piece Ball Valve, Model 5975.8	10
Product Instructions	11
Viega MegaPress ½" to 2" Fittings	11
Viega MegaPress 2½" to 4" Fittings	12
Technical Information	13
Approved Applications	13
Sealing Element Description	15
Viega MegaPress Pipe Marking Guide	16
No-Stop Couplings	17
Welding	17
Minimum Distance Between MegaPress Connections	17
General Installation Notes	18
Deflection	19
Viega MegaPress Pipe Preparation Guide	20
Tool Clearances	21
Pressing with Ring and Actuator in Tight Quarters	23
Dimensional Documentation	25
MegaPress Fittings	25
Frequently Asked Questions	39
Limited Warranty	41
Viega MegaPress Limited Warranty	41
Viega MegaPressG Limited Warranty	42
Viega Metal Systems for Industrial Applications Limited Warranty	43



This document is subject to updates. For the most current Viega technical literature please visit www.viega.us.



Viega products are designed to be installed by licensed and trained plumbing and mechanical professionals who are familiar with Viega products and their installation. **Installation by non-professionals may void Viega LLC's warranty.**

MegaPress, MegaPress FKM, and MegaPressG Systems

Viega MegaPress systems are state-of-the-art Iron Pipe Size (IPS) press fitting systems that provide an economical and reliable installation of schedule 5 to schedule 40 carbon steel pipes.

Viega MegaPressG fittings for fuel gas or fuel oil systems shall be used with ASTM A53 schedule 10 and schedule 40 carbon steel pipe. MegaPressG is ANSI LC-4/CSA 6.32 approved for fuel gas installations.

Viega MegaPress fittings and valves are constructed of carbon steel with a corrosion-resistant zinc/nickel coating ranging from 1/2" to 2" for MegaPress and 1/2" to 4" for MegaPress FKM and MegaPressG.

The Viega MegaPress fitting system is offered in configurations that allow for the installation of the vast majority of carbon steel piping applications in the residential, commercial, and industrial markets. MegaPress fittings may be used with seamless (S) or longitudinal welded (W) steel pipes.

MegaPress fittings feature a green dot with an EPDM sealing element while MegaPress FKM fittings have a white dot with an FKM sealing element. MegaPressG fittings have a yellow dot with an HNBR sealing element. All use Viega's unique Smart Connect technology to help installers ensure that they have pressed all connections.

MegaPress 1/2" to 2" fittings with an EPDM sealing element and MegaPress FKM 2 1/2" to 4" fittings may be installed in NFPA 13, 13R, and 13D fire sprinkler systems. They are certified for use in "wet" and "dry" fire protection systems in accordance with UL and FM certifications:

- ANSI/CAN/UL 213: Standard for Rubber Gasketed Fittings for Fire-Protection Services.
- FM Class 1920: Pipe Couplings and Fittings for Aboveground Fire Protection Systems.

Viega MegaPress systems can help reduce installation time up to 90 percent compared to traditional methods of pipe joining. Threading and welding can be messy and time consuming, and connections are not always reliable. With Viega press technology, installers can make consistent, secure press connections in a matter of seconds without flame or heavy equipment.

The fittings require no soldering or welding and are installed with electro-hydraulic press tools (battery-powered or corded press tools).

Viega MegaPress fittings can be utilized for a wide variety of applications in industrial, commercial, or residential projects.



DANGER!

Read and understand all instructions for installing Viega MegaPress fittings. Failure to follow all instructions may result in extensive property damage, serious injury, or death.

Smart Connect Technology – Security Under Pressure

Locating unpressed connections is an important step in the pressure testing process. Viega MegaPress fittings include Smart Connect technology, providing quick and easy identification of unpressed connections during a pressure test.

Smart Connect technology is a design of the fitting, providing a path for liquids and/or gases from inside the system past the sealing element of an unpressed connection. When pressed according to our Product Instructions, the fluid path is altered, creating a leak-proof, reliable connection.

Unpressed connections are located by pressurizing the system with air or water. When testing with water the proper pressure range is 15 to 85 psi. Pressure testing with air can be dangerous at high pressures. When testing with compressed air the proper pressure range is ½ to 45 psi. Following a successful Smart Connect test, the system may be pressure tested up to 600 psi maximum for water and 200 psi maximum for air if required by local code requirements.



1 Identify an unpressed connection during pressure testing when water flows past the sealing element.

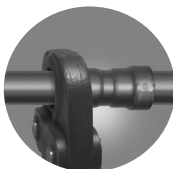

2 Upon identification, use the press tool to press the fitting, making a secure, leak-proof connection.

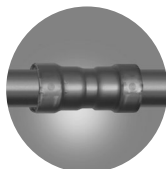

3 Viega MegaPress connections are fast, flameless, and reliable.

Viega MegaPress Fittings

MegaPress is a carbon steel, cold press system designed for use in chilled water, hydronic heating, compressed air, and fire sprinkler applications.

MegaPress fittings in sizes from 1/2" to 2" are offered in configurations including: elbows, couplings, no-stop couplings, reducers, tees, reducing tees, adapters, reducing adapters, unions, caps, and flanges.

Components

- Alloy: carbon steel with corrosion-resistant zinc/nickel coating
- EPDM sealing element
- 420 stainless steel grip ring
- 304 stainless steel separator ring

Operating Parameters

- Operating Pressure: 200 psi max
- Test Pressure: 600 psi max
- Operating Temperatures: 0°F to 250°F

Listings and Certificates

- ANSI/CAN/UL 213
- ASME B31.1, B31.3, B31.9
- ASTM F3226
- CRN 23019.5 A/B/C
- FM Class 1920
- IAPMO PS117
- ICC LC1002
- NFPA 13, 13D, 13R

Compliant With

- ASME B31: Code for Pressure Piping
- IAPMO Uniform Mechanical Code (UMC)
- ICC International Mechanical Code (IMC)
- ICC International Residential Code (IRC)
- National Building Code of Canada (NBCC)
- National Plumbing Code of Canada (NPCC)

Approved Applications

- Hydronics
- Low pressure steam
- Industrial gases
- Compress air (no oil)
- Fire sprinkler
- Vacuum

MegaPress fittings with an EPDM seal are not approved for potable water or fuel gas applications. For more specific information on applications for MegaPress, contact Viega Technical Services at 1-800-976-9819.

MegaPress 1/2" to 2" systems are approved for underground use and must be protected against corrosion in accordance with NFPA 54 section 404.8, NACE Standard RP0169-2002 section 5, 2009 UPC Chapter 6 section 609.3.1, 2009 UMC Chapter 13 section 1312.1.3, and in accordance with local and national codes.

MegaPress fittings are designed for use in piping systems utilizing ASTM A53, A106, A135, and A795 Schedule 5 to Schedule 40 carbon steel pipe.

Recommended Tools

- Standard size press tool (minimum hydraulic ram output of 7200 lbs.)
- #56013 MegaPress jaw/ring kit

Smart Connect® Technology

MegaPress fittings are manufactured with Viega's unique Smart Connect technology. A design of the fitting, Smart Connect technology allows identification of an unpressed fitting during pressure testing.



The use of the system for applications other than those listed or outside of these parameters must be approved by the Viega Technical Services Department.



It is the responsibility of the installer or any other parties to adhere to all applicable local rules and regulations governing the nature of the installation.

Viega MegaPress FKM Fittings

MegaPress FKM is a carbon steel, cold press system designed for use in chilled water, hydronic heating, compressed air, and fire sprinkler applications.

MegaPress FKM fittings in sizes from ½" to 4" are offered in configurations including: elbows, couplings, no-stop couplings, reducers, tees, reducing tees, adapters, unions, caps, and flanges.

Components

- Alloy: carbon steel with corrosion-resistant zinc/nickel coating
- FKM sealing element
- 420 stainless steel grip ring
- 304 stainless steel separator ring for ½" to 2" fittings
- PBT separator ring for 2½" to 4" fittings

Operating Parameters

- Operating Pressure: 200 psi max
- Test Pressure: 600 psi max
- Operating Temperatures: 14°F to 284°F (with temperature spikes up to 356°F)

Listings and Certificates

- ANSI/CAN/UL 213 The following apply to 2½" to 4" fittings only:
- ASME B31.1, B31.3, B31.9
- ASTM F3226 ■ FM Class 1920
- CRN 23019.5
- A/B/C
- IAPMO PS117
- ICC LC1002
- NFPA 13, 13D, 13R

Compliant With

- ASME B31: Code for Pressure Piping
- IAPMO Uniform Mechanical Code (UMC)
- ICC International Mechanical Code (IMC)
- ICC International Residential Code (IRC)
- National Building Code of Canada (NBCC)
- National Plumbing Code of Canada (NPCC)

Approved Applications

- Fire Sprinkler
- Hydronics
- Low Pressure Steam
- Fuel Oil
- Industrial Gases
- Compressed Air
- Vacuum

MegaPress FKM is not approved for potable water application. For more specific information on applications for MegaPress FKM, contact Viega Technical Services at 1-800-976-9819.

MegaPress FKM systems are approved for underground use and must be protected against corrosion in accordance with NFPA 54 section 404.8, NACE Standard RP0169-2002 section 5, 2009 UPC Chapter 6 section 609.3.1, 2009 UMC Chapter 13 section 1312.1.3, and in accordance with local and national codes.

MegaPress FKM fittings are designed for use in piping systems utilizing ASTM A53, A106, A135, and A795 Schedule 5 to Schedule 40 carbon steel pipe.

Recommended Tools

- Standard size press tool (minimum hydraulic ram output of 7200 lbs.)
- #56013 MegaPress jaw/ring kit (½" to 2")
- Viega 26200 PressBooster with 2½" MegaPress XL ring
- Viega 26201 3" and 4" MegaPress XL rings
- #57081 Z3 Actuator with 2½" ring (must be used with press gun with minimum 80mm press stroke)

Smart Connect® Technology

MegaPress FKM fittings are manufactured with Viega's unique Smart Connect technology. A design of the fitting, Smart Connect technology allows identification of an unpressed fitting during pressure testing.

Viega MegaPressG Fittings

Viega MegaPressG is a carbon steel, cold press fitting system designed for use in fuel gas systems and applications with a high oil content. MegaPressG fittings in sizes from 1/2" to 4" are offered in numerous configurations.

Components

- Alloy: carbon steel with corrosion-resistant zinc/nickel coating
- HNBR sealing element
- 420 stainless steel grip ring
- 304 stainless steel separator ring for 1/2" to 2" fittings
- Graphite separator ring for 2 1/2" to 4" fittings

Operating Parameters

- Operating Pressure: 125 psi max for fuel gas applications
200 psi max for other approved applications
- Test Pressure: 600 psi max
- Operating Temperatures: -40 to 180°F

Approved Piping

- Fuel gas applications: ASTM A53 Schedule 10 to Schedule 40 carbon steel pipe
- Non-fuel gas applications: ASTM A53, A106, A135, and A795 Schedule 5 to Schedule 40 carbon steel pipe. Schedule 80 pipe may be used but operating pressures are limited to Viega Approved Applications guide.



Adopted code versions, standards compliance, and local approvals should be considered for selecting pipe schedule and type.

Listings and Certifications

- ASME B31.1, B31.3, B31.9
- ASTM F3226
- CRN 23019.5 A/B/C
- CSA: ANSI LC 4a/CSA 6.32a
- IAPMO: ANSI LC 4a/CSA 6.32a
- ICC-ES: ANSI LC 4a/CSA 6.32a

Compliant With

- CAN/CSA-B149.1
- IAPMO National Standard Plumbing Code (NSPC)
- IAPMO Uniform Mechanical Code (UMC)
- IAPMO Uniform Plumbing Code (UPC)
- ICC International Fuel Gas Code (IFGC)
- ICC International Residential Code (IRC)
- NFPA 54/Z223: National Fuel Gas Code
- NFPA 58: Liquefied Petroleum Gas Code

Approved Applications

- Natural gas
- Propane gas
- Lubricants/oils
- Compressed air
- Industrial gases
- Vacuum

For more specific information on applications for MegaPressG, contact Viega Technical Services at 1-800-976-9819.

Viega MegaPressG systems are approved for underground use and must be protected against corrosion in accordance with NFPA 54 section 404.8, NACE Standard RP0169-2002 section 5, 2009 UPC Chapter 6 section 609.3.1, 2009 UMC Chapter 13 section 1312.1.3, and in accordance with local and national codes.

Recommended Tools

- Standard size press tool (minimum hydraulic ram output of 7200 lbs.)
- #56013 MegaPress jaw/ring kit (1/2" to 2")
- #26200 MegaPress XL PressBooster with 2 1/2" press ring
- #26201 MegaPress XL 3" and 4" press ring kit
- #57081 Z3 Actuator with 2 1/2" ring (must be used with press gun with minimum 80mm press stroke)

Smart Connect® Technology

Viega MegaPressG fittings are manufactured with Viega's unique Smart Connect technology. A design of the fitting, Viega Smart Connect technology allows identification of an unpressed fitting during pressure testing.

Viega MegaPress 3-Piece Ball Valve, Model 4875.8

The MegaPress EPDM 3-piece carbon steel ball valve is equipped with a full port, 316 stainless steel 3-piece body, and zinc/nickel coated steel press ends. The ball valve features an EPDM sealing element, a 420 stainless grip ring, a 304 stainless separator ring, PTFE stem seals, a locking metal handle, and Viega's Smart Connect technology for easy identification of unpressed connections during pressure testing.

Recommended Tools

- Standard size press tool (minimum hydraulic ram output of 7200 lbs.)
- #56013 MegaPress jaw/ring kit (1/2" to 2")

Features

- 316 stainless steel ball
- Blowout-proof 316 stainless steel stem
- 304 stainless steel locking handle
- Adjustable packing nut
- Reinforced PTFE seats
- Smart Connect technology
- ISO 5211 mounting pad

Ratings

- Temperature Range: 0°F - 250°F
- Max. Operating Pressure: 250 CWP

Approvals

- Conforms to MSS SP-110
- ASME B31
- IAPMO Z1157

Viega MegaPress EPDM 3-Piece Carbon Steel Ball Valve - Model 4875.8

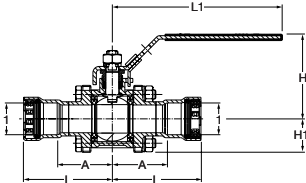

Part No.	Size (in)	A (in)	L (in)	L1 (in)	H (in)	H1 (in)
	1					
28500	1/2	1.72	2.80	5.88	2.85	1.04
28501	3/4	1.91	3.06	5.88	2.93	1.16
28502	1	2.19	3.54	7.54	3.33	1.40
28503	1 1/4	2.50	4.31	7.54	3.57	1.57
28504	1 1/2	2.92	4.79	7.54	3.89	1.83
28505	2	3.09	5.07	7.54	3.89	1.83

Valve Size (in)	Valve Body Bolt & Nut Size		Bolt Torque +/- 5		Valve Stem Nut Size	Stem Nut	
			ft/lbs	(Nm)		ft/lbs	(Nm)
1/2	M8 x 55	M8	7.5	(10)	AF 16 mm	7.5	10
3/4	M8 x 65	M8	15	(20)	AF 18 mm	11	15
1	M10 x 75	M10	15	(20)	AF 21 mm	11	15
1 1/4	M10 x 90	M10	22.5	(30)	AF 22 mm	18.5	25
1 1/2	M10 x 100	M10	22.5	(30)	AF 24 mm	18.5	25
2	M10 x 100	M10	22.5	(30)	AF 24 mm	18.5	25

Viega MegaPress FKM 3-Piece Ball Valve, Model 5975.8

The MegaPress FKM 3-piece carbon steel ball valve is equipped with a full port, 316 stainless steel 3-piece body, and zinc/nickel coated steel press ends. The ball valve features an FKM sealing element, a 420 stainless grip ring, a 304 stainless separator ring, PTFE stem seals, a locking metal handle, and Viega's Smart Connect technology for easy identification of unpressed connections during pressure testing.

Recommended Tools

- Standard size press tool (minimum hydraulic ram output of 7200 lbs.)
- #56013 MegaPress jaw/ring kit (1/2" to 2")

Features

- 316 stainless steel ball
- Blowout-proof 316 stainless steel stem
- 304 stainless steel locking handle
- Adjustable packing nut
- Reinforced PTFE seats
- Smart Connect technology
- ISO 5211 mounting pad

Ratings

- Operating Temperatures: 14°F to 284°F (with temperature spikes up to 356°F)
- Max. Operating Pressure: 250 CWP

Approvals

- Conforms to MSS SP-110
- ASME B31
- IAPMO Z1157

Viega MegaPress FKM 3-Piece Carbon Steel Ball Valve - Model 5975.8

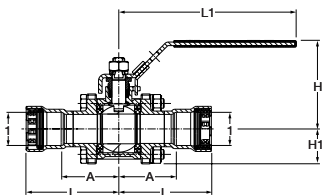

Part No.	Size (in)	A (in)	L (in)	L1 (in)	H (in)	H1 (in)
	1					
86400	1/2	1.72	2.80	5.88	2.85	1.04
86405	3/4	1.91	3.06	5.88	2.93	1.16
86410	1	2.19	3.54	7.54	3.33	1.40
86415	1 1/4	2.50	4.31	7.54	3.57	1.57
86420	1 1/2	2.92	4.79	7.54	3.89	1.83
86425	2	3.09	5.07	7.54	3.89	1.83

Valve Size (in)	Valve Body Bolt & Nut Size		Bolt Torque +/- 5		Valve Stem Nut Size	Stem Nut	
			ft/lbs	(Nm)		ft/lbs	(Nm)
3/4	M8 x 65	M8	15	(20)	AF 18 mm	11	15
1	M10 x 75	M10	15	(20)	AF 21 mm	11	15
1 1/4	M10 x 90	M10	22.5	(30)	AF 22 mm	18.5	25
1 1/2	M10 x 100	M10	22.5	(30)	AF 24 mm	18.5	25
2	M10 x 100	M10	22.5	(30)	AF 24 mm	18.5	25

Viega MegaPress ½" to 2" Fittings

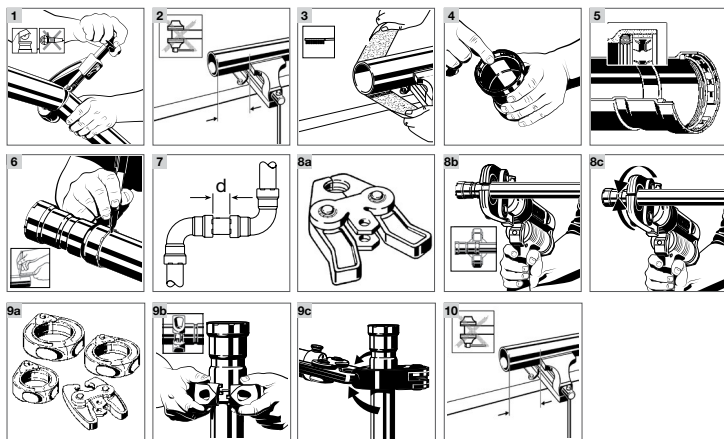

- 1** Cut piping at right angles using displacement-type cutter.
- 2** Keep end of piping a minimum of 4" away from the contact area of the vise to prevent possible damage to the piping.
- 3** Deburr inside and outside of the pipe and prep to proper insertion depth using a preparation tool or fine-grit sandpaper.
- 4** Check seal and grip ring for correct fit. Do not use oils or lubricants.
- 5** Illustration demonstrates proper fit of grip ring, separation ring, and sealing element.
- 6** Mark proper insertion depth. Improper insertion depth may result in an improper seal. The depth marking must be visible on the completed assembly.

- 8a** Viega MegaPress ½" to 1" fitting connections must be performed with MegaPress jaws.



WARNING!

Keep extremities and foreign objects away from press tool during pressing operation to prevent injury or incomplete press.

- 8b** Open the MegaPress jaw and place at right angles on the fitting. Visually check insertion depth using mark on piping.
- 8c** Start pressing process and hold the trigger until the jaw has engaged the fitting.
- 9a** MegaPress 1¼" to 2" fitting connections must be performed with MegaPress rings and V2 actuator.
- 9b** Open MegaPress ring and place at right angles on the fitting. MegaPress ring must be engaged on the fitting bead. Check insertion depth.
- 9c** Place V2 actuator onto MegaPress ring and start pressing process. Hold the trigger until the actuator has engaged the MegaPress ring.
- 10** Remove MegaPress jaw from fitting or release V2 actuator from MegaPress ring and then remove MegaPress ring from the fitting. Remove control label to indicate press has been completed.

Minimum Insertion Depth for MegaPress

Pipe Size	½"	¾"	1"	1¼"	1½"	2"
Insertion Depth	1¼"	1½"	1¾"	1¾"	1¾"	2"

- 7** Refer to chart on page 17 for minimum distance between fittings. To ensure a correct press, a minimum distance between press fittings must be maintained. Failure to provide this distance may result in an improper seal.

Viega MegaPress 2½" to 4" Fittings

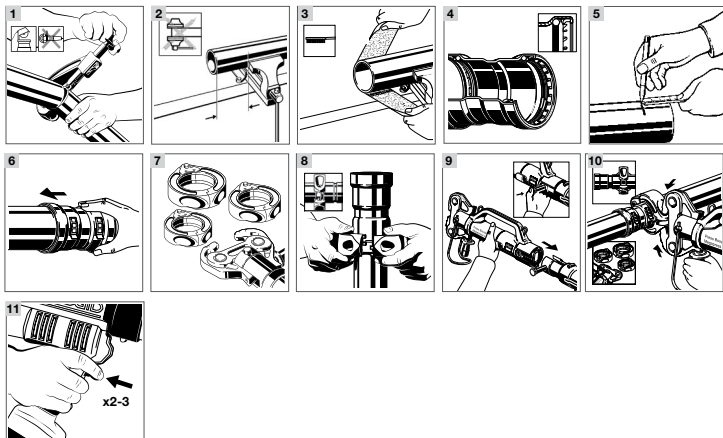

- 1** Cut piping at right angles using displacement-type cutter.
- 2** Keep end of piping a minimum of 4" away from the contact area of the vise to prevent damage to the piping in the press area.
- 3** Deburr inside and outside of piping and prep to proper insertion depth using a preparation tool or fine-grit sandpaper.
- 4** Illustration demonstrates proper fit of grip ring, separation ring, and sealing element.
- 5** Mark the proper insertion depth on the outside of the pipe (see table below). Improper insertion depth may result in an improper seal. The depth marking should be visible on the completed assembly.

**Minimum Insertion Depth for
MegaPress 2½" to 4"**

Pipe Size	2½"	3"	4"
Insertion Depth	1 13/16"	2 5/16"	3 3/8"

- 6** While turning slightly, slide press fitting onto the pipe to the marked insertion depth. End of pipe must contact stop.



WARNING!

Keep extremities and foreign objects away from press tool during pressing operation to prevent injury or incomplete press.

- 7** Viega MegaPress a 2½" to 4" fitting connections must be made using MegaPress XL rings and a PressBooster/Z3 actuator.
- 8** Open MegaPress ring and place at right angles on the fitting. MegaPress ring must be engaged on the fitting bead. Check insertion depth.
- 9** Remove the retaining bolt of the press machine. Slide the PressBooster in via the press jaw fixture.
- 10** Place PressBooster/Z3 actuator onto MegaPress XL rings and start pressing process. Hold the trigger until the actuator has engaged the MegaPress ring.
- 11** The PressBooster requires two presses of the trigger to execute a complete press. A third press may be needed to initiate a release cycle to reset the rollers back to the original position.

Approved Applications

Media ¹	System Operating Conditions			Product Line, Material, and Sealing Element ²				
				MegaPress	MegaPressG	Carbon Steel		
	Comments	Max Pressure (psig)	Temperature Range (°F)	EPDM	FKM	HNBR		
Water/Liquids								
Chilled Water	≤50% Ethylene / Propylene glycol	200	See note ³	✓	✓			
Hydronic Heating Water	≤50% Ethylene / Propylene glycol			✓	✓			
Isopropyl alcohol			Ambient ⁵	✓	✓			
Fire Sprinkler	NFPA 13, 13D, 13R	175		✓	✓			
Steam	Low-pressure	15	Max 250°		✓ ⁴			
	Residential	5	Max 227°	✓ ⁴	✓ ⁴			
Fuels/Oils/Lubricants								
Mineral Oil		200	Ambient ⁵		✓	✓		
Lube Oil	Petroleum based			Max 150°		✓	✓	
Biodiesel	ASTM D6751	140			✓			
Propane		125	-40° to 180			✓ ⁶		
Butane							✓ ⁶	
Natural Gas	Primarily methane							✓ ⁶
Heating Fuel Oil					Max 100°		✓	✓
Diesel Fuel					✓	✓		
Kerosene			Max 68°		✓			
Gases								
Compressed Air	Oil Concentration ≤25 mg/m ³	200	Max 140°	✓ ⁴	✓ ⁴	✓ ⁴		
	Oil Concentration >25 mg/m ³				✓ ⁴	✓ ⁴		
Nitrogen - N ₂				✓	✓	✓		
Carbon Dioxide - CO ₂	Dry			✓	✓	✓		
Argon - Ar				✓	✓	✓		
Oxygen - O ₂	Non-medical Keep free of oil and grease	140	Max 140°	✓				
Hydrogen - H ₂		125		✓	✓	✓		
Acetylene	Test pressure 350 psi	20	Ambient ⁵	✓	✓	✓		
Vacuum	Minimum absolute pressure Maximum differential pressure	750µm Hg 29.2" Hg	Max 160°	✓	✓	✓		

¹ It is recommended that all systems be clearly labeled with the media being conveyed. For further information please consult Viega Technical Services.

² All Viega systems must be used with the manufacturer's recommended sealing element. Contact your local Viega representative or Viega Technical Services for specific application temperature, pressure, and concentration limits.

³ System pressure and temperature ranges depend on sealing element. Any ranges listed above will be overruled by the sealing element limits here:

^{3a} EPDM temperature ranges are typically 0°F to 250°F.

^{3b} FKM temperature ranges are typically 14°F to 284°F with temperature spikes (24hr) up to 356°F.

^{3c} HNBR temperature ranges are typically -40°F to 180°F.

⁴ System must contain adequate condensate drainage.

⁵ Ambient temperatures should be taken as normal operating conditions for the applications not to exceed sealing element limitations.

⁶ Compliant with CSA 6.32 / ANSI LC-4.

**Caution!**

MegaPressG fittings are for use with fuel gases and are intended for the operating pressure 0-125 psi.

**Caution!**

MegaPressG fuel gas system shall not be used as a grounding electrode for an electrical system.



The installation, inspection, testing, and purging of the fuel gas system shall be in accordance with local codes or, in the absence of local codes, in accordance with the International Fuel Gas Code, NFPA 54/National Fuel Gas Code z223.1, the Uniform Plumbing Code, NFPA 58, or CSA B 149.1 as applicable.

Sealing Element Description

EPDM Sealing Element

MegaPress press fittings are manufactured with an EPDM sealing element installed at the factory. The EPDM sealing element is used mainly for hydronic heating, fire sprinkler, and compressed air installations.

Definition: EPDM
Ethylene-Propylene-Diene-Monomer, gloss black in color

Operating Temperature: 0°F to 250°F

The EPDM sealing element is a synthetically manufactured and peroxidically cross-linked, general-purpose elastomer with a wide range of applications. It is resistant to aging, ozone, sunlight, weathering, environmental influences, chemicals, and most alkaline solutions.

The EPDM sealing element is used mainly in the applications of hydronic heating, chilled water, and fire sprinkler installations. It is not resistant to hydrocarbon solvent solutions, oils, chlorinated hydrocarbons, turpentine, and gasoline.

FKM Sealing Element

MegaPress FKM press fittings are manufactured with an FKM sealing element installed at the factory. FKM is well known for its excellent resistance to petroleum products and solvents as well as exceptional high-temperature performance, which make it ideal for seals and gaskets in solar, district heating, low pressure steam, and compressed air systems.

Definition: FKM
Fluoroelastomer, dull black in color

Operating Temperature: 14°F to 284°F
(with temperature spikes up to 356°F)

The FKM sealing element is a special-purpose elastomer typically installed where higher temperatures are required. It possesses excellent resistance to aging, ozone, sunlight, weathering, environmental influences, and oils and petroleum-based additives.

HNBR Sealing Element

MegaPressG press fittings are manufactured with an HNBR sealing element installed at the factory. The HNBR sealing element is used mainly for natural gas, propane, mixed and manufactured gases in the vapor state. It is commonly used in fuel oil heating systems.

Definition: HNBR
Hydrogenated Nitrile Butadiene Rubber, yellow in color

Operating Temperature: -40°F to 180°F

HNBR is widely known for its physical strength and retention of its properties after long-term exposure to heat, oil, and chemicals.

The unique properties of the HNBR sealing element have resulted in the wide adoption of it in automotive, industrial, and assorted performance-demanding applications (e.g., engine seals, grommets, and gaskets; fuel system seals and hoses; transmission system bonded piston seals; chevron seals, oil field packers, and rotary shaft seals).

The HNBR sealing element is not suitable for food contact applications and cannot be installed in drinking water applications.

Viega MegaPress Pipe Marking Guide

Viega MegaPress ½" to 4" fittings are compatible with ASTM A53, A135, A106, and A795 carbon steel and galvanized steel pipe. All Viega MegaPress piping systems should be continuously marked in accordance with ANSI A13.1 or as required by the local authority having jurisdiction.

Usage	Material Properties	Type of Application (typical)	Color Scheme
Hazardous Materials	<ul style="list-style-type: none"> ■ Flammable or Explosive ■ Chemically Active or Toxic ■ Radioactive ■ Extreme Temperature/Pressure 	<ul style="list-style-type: none"> ■ Process Piping ■ High-Pressure Steam ■ Acids/Corrosives 	YELLOW ON BLACK
Low Hazard Materials (Liquid)	<ul style="list-style-type: none"> ■ Liquid ■ Liquid Admixture 	<ul style="list-style-type: none"> ■ Cooling Water ■ Grey Water ■ Chilled Water 	WHITE ON GREEN
Low Hazard Materials (Gas)	<ul style="list-style-type: none"> ■ Gas ■ Gas Admixture 	<ul style="list-style-type: none"> ■ Compression Air ■ Nitrogen (N2) ■ Argon (Ar) 	WHITE ON BLUE
Fire Suppression	<ul style="list-style-type: none"> ■ Liquid ■ Gas ■ Foam 	<ul style="list-style-type: none"> ■ Sprinklers (Wet/Dry) ■ CO2 ■ Foam (AFFF) 	WHITE ON RED

Marker Placement

- At all changes in direction
- At both sides of any penetrations (valves, flanges, tees, etc.)
- At frequent intervals on straight run (50 feet is typical)
- Locate pipe markers so they are readily visible
- Provide arrows indicating direction of flow

Note: This guide is for general information purposes only. Pipe markings shall be in accordance with local code requirements.

Pipe O.D. Including Covering	Minimum Length of Label	Minimum Height of Letters
	Field Color	
¾" to 1¼"	19 mm to 32 mm	8"
1½" to 2"	38 mm to 51 mm	8"
2½" to 4"	64 mm to 108 mm	12"

No-Stop Couplings

No-stop couplings and extended no-stop couplings are often used to conduct repairs. Without a stop, these couplings can slide completely onto a pipe and allow a connection to be made in tighter spaces. Unlike fittings with an integrated stop that have a minimum insertion depth, no-stop couplings have minimum and maximum allowable insertion depths. The minimum and the maximum insertion depths should be marked and a line should connect the two marks.

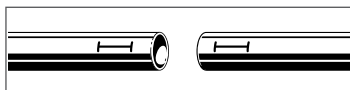

Viega MegaPress No-Stop Couplings

Pipe Diameter	Minimum Insertion	Maximum Insertion		
inches	inches	mm	inches	mm
1/2	1 1/16	27	1 5/8	41
3/4	1 3/16	29	1 13/16	46
1	1 3/8	34	1 15/16	49
1 1/4	1 13/16	46	2 1/2	63
1 1/2	1 7/8	48	2 3/4	70
2	2	50	2 3/4	70
2 1/2	1 13/16	46	3 1/8	79
3	2 5/16	59	3 11/16	93
4	3 1/8	80	4 3/8	120

Viega MegaPress Extended No-Stop Couplings

Pipe Diameter	Minimum Insertion	Maximum Insertion		
inches	inches	mm	inches	mm
1/2	1 1/16	27	2 3/4	70
3/4	1 3/16	29	2	72
1	1 3/8	34	3	77
1 1/4	1 13/16	46	3 1/2	89
1 1/2	1 7/8	48	3	91
2	2	50	3	93

Welding

The following requirements must be considered when welding in the same vicinity as Viega MegaPress fittings.

Welding Requirements

The installer should take precautions to keep the MegaPress connection cool:

- Wrap the connection with a cold wet rag.
- Protect the connection with a weld blanket.
- Prefabricate solder connections/welded fittings prior to installing the press fitting. (Ensure pipe has cooled before installing the press fitting.)
- Apply heat sink gel or spray or spot freezing.

Welding Adjacent to a Press Fitting

To prevent damage to the sealing element, maintain proper welding distances from the fitting. If welding adjacent to the connection, weld a minimum of four inches away.

Welding In Line with a Press Fitting

To prevent damage to the sealing element, maintain proper welding distances from the fitting. If welding in line with the connection, weld a minimum of three feet away from the connection.

Minimum Distance Between MegaPress Connections

Viega MegaPress Minimum Distance

Pipe Diameter	Minimum Distance	
inches	inches	mm
1/2	1/4	6
3/4	1/4	6
1	1/4	6
1 1/4	1/2	13
1 1/2	1/2	13
2	1/2	13
2 1/2	1/2	13
3	1/2	13
4	1/2	13

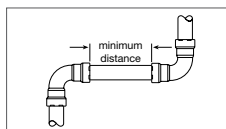

General Installation Notes

Expansion

Thermal expansion in installed systems generates stress on pipes and appliance connectors. Compensation must be allowed for expansion and contraction that may occur within the piping system. Expansion joints or mechanical expansion compensators may be used to alleviate these stresses.

Electrical Bonding

When properly installed, MegaPress fittings comply with Section 1211.15 Electrical Bonding and Grounding of the Uniform Plumbing Code.

The mechanical press provides continuous metal-to-metal contact between fitting and pipe. The press ensures the continuity of the bonding through this contact.

Exposure to Freezing Temperatures

Viega MegaPress systems with EPDM sealing elements can be installed in ambient temperatures down to 0°F. The FKM sealing element available with Viega MegaPress FKM fittings can be installed in ambient temperatures down to 14°F. The HNBR sealing element available with Viega MegaPressG fittings can be installed in ambient temperatures down to -40°F. When the contents could freeze, piping must be protected per acceptable engineering practices, codes, and as required by local code.

Underground Installations

Viega MegaPress fitting systems and carbon steel pipe are approved for underground installations. However, installations must meet all state and local codes, including those for underground. Proper authorization must be obtained prior to installation from the Authority Having Jurisdiction.

Concealed Spaces

Viega MegaPressG has been examined according to the construction and performance criteria in the ANSI LC-4/CSA 6.32 requirement and was found acceptable. Specific performance tests were conducted to evaluate the fittings for use in concealed locations.

Corrosion Protection

Viega MegaPress fittings exposed to corrosive action, such as soil conditions or moisture, must be protected in an approved manner in accordance with NFPA 54 Section 404.8, NACE Standard RP0169-2002 Section 5, 2009 UPC Chapter 6 Section 609.3.1, 2009 UMC Chapter 13 Section 1312.1.3, and in a manner satisfactory to local code requirements. Care should be taken to select hangers of suitable material that is galvanically compatible with the piping system. In addition, systems should be properly sized to minimize the risk of erosion corrosion resulting from excessive velocities.

Transition Fittings – Threaded

Viega MegaPress systems can be joined with off-the-shelf threaded fittings made of non-ferrous metals. In this regard:

- The threaded connection is made first.
- The press connection is made second.

This process avoids unnecessary torsion on the press fitting.

Transition Fittings – Flange

When using Viega flanges, bolt the flange end in place prior to pressing the fitting to the pipe.

Deflection

The pressing process can cause deflection (angular misalignment) to occur. When pressing Viega MegaPress fittings in a system, the deformation of the fitting is constant. This allows for a consistent leak-free joint every time and is a result of the pressing technique.

Deflection occurs in the same way for every fitting. The fitting being pressed will move in the direction of the jaw or ring opening.

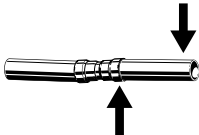

- Since the fitting will deflect toward the opening of the jaw or ring, the pipe end will deflect in the opposite direction.
- By counteracting the fitting movement, one can minimize the deflection of the fitting and ultimately the pipe.
- When using strut and clamps, deflection is minimized and nearly eliminated depending on clamp spacing.

Controlling Deflection

Deflection while pressing can be minimized by utilizing the following installation practices.

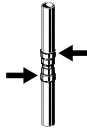

Alternate Press Directions

- Press one end of fitting.
- Make second press on other end of fitting from the opposite side.

Push-Pull Method

- Rings = Push on press tool.
 - Jaws = Pull on press tool.
- The press tool can be feathered using the trigger as needed to apply pulling or pushing force to control deflection.

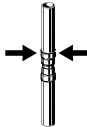
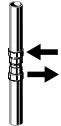





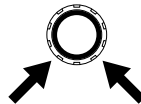



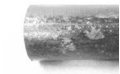

Re-Press

- Press the fitting, once on each side (that is, re-press the fitting a second time on the opposite side).
- Pressing the same connection from the opposite side will usually straighten misalignment between the pipe and fitting.

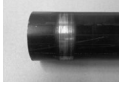

- When pressing overhead piping, it may be inconvenient to alternate sides for each press.
- The natural weight of the piping plus pressing on opposite sides at a 45-degree angle should adequately eliminate deflection.
- This technique can also be used for any horizontal piping and when working above the piping.

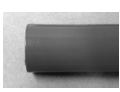
Viega MegaPress Pipe Preparation Guide

Description	Different kinds of pipe surface	Surface after prepping	Comments
Clean, bare pipe			If the pipe has no lacquer and there is no rust on the surface and the surface is smooth, no preparing is necessary.
Galvanized steel pipe			If the surface of the galvanized pipe is uneven, then the pipe surface must be smoothed.
Pipe with black shellac or lacquer			If the pipe is coated with black shellac or lacquer, the coating has to be smoothed. It is not necessary to completely remove the coating.
Pipe with rust			If the pipe has no lacquer and there is a rust film on the surface, the surface has to be prepped until the rust film is removed and the pipe surface is smooth.
Epoxy coating			The epoxy coating must be reduced to allow the pipe to be inserted into the fitting. If the pipe has been coated, the maximum external diameter must not exceed the limit in the Pipe Schedule table.
Cataphoretic paint (KTL)			If the pipe is cataphoretic painted (KTL) and the surface is smooth, it is not necessary to prep the pipe. If there are scratches on the KTL, the surface has to be smoothed.

Pipe surfaces for each type of pipe must be smooth, free of indentations (even and undamaged), pits, and deformations and must be clean and free of dirt, debris, rust, scale, oil, and grease. It is not necessary to completely remove protective coatings or to expose the bare steel material.

To avoid leak paths, engraved or stamped pipe shall not be used with the Viega MegaPress fitting system. Engraving or stamping shall not be removed through use of a grinder or other tool. Scratches or scuffs that may have occurred to the pipe during shipping and handling must be smoothed out to insure no leak path was created.

In systems where complete corrosion protection is required (e.g., cooling systems), apply suitable corrosion protection to the previously processed pipe surfaces that are still uncovered after pressing.

The Viega MegaPress system does not require lubrication of the pipe or the fitting.

Tool Clearances

Minimum distances should be taken into consideration during planning in order to avoid space constraints during installation.

Ensure that the space required for system pressing tools is available if Viega MegaPress fittings will be installed immediately upstream or downstream from wall or floor penetrations.

MegaPress Distance Requirements for Press Jaws Between Pipes and Walls

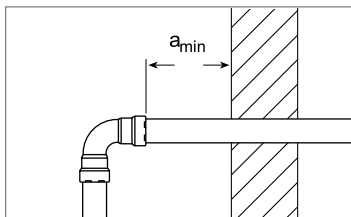

Pipe Diameter	Minimum space requirement, a_{min} for press tools
	RIDGID RP 330-B, 330-C, and 340-B Press Tool
½" to 1"	1½"
1¼" to 2"	¾"
2½" to 4"	¾"

MegaPress Standard Jaws Clearance

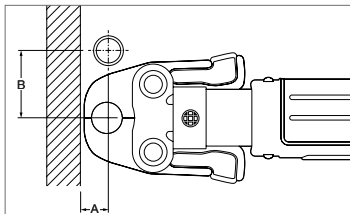

Pipe Diameter	A minimum	B minimum
½"	1	2½"
¾"	1¼"	3½"
1"	1¾"	3½"

MegaPress Compact Jaws Clearance

Pipe Diameter	A minimum	B minimum
½"	1¼"	2½"
¾"	1½"	3"

MegaPress Standard Jaws Clearance Between Pipe, Wall, and Floor

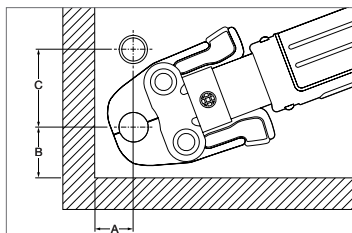

Pipe Diameter	A minimum	B minimum	C minimum
1/2"	1 1/4"	1 3/8"	3"
3/4"	1 1/2"	2 1/8"	3 1/2"
1"	2"	1 1/2"	4"

MegaPress Compact Jaws Clearance Between Pipe, Wall, and Floor

Pipe Diameter	A minimum	B minimum	C minimum
1/2"	1 1/2"	2 1/8"	3 3/8"
3/4"	1 3/8"	2 1/8"	3 3/8"

MegaPress Rings Dimensions

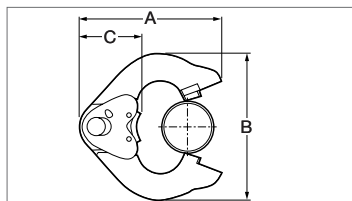

Pipe Diameter	A minimum	B minimum	C minimum
1 1/4"	6"	6 1/4"	2 1/2"
1 1/2"	6"	6 3/4"	2 5/8"
2"	6"	6 7/8"	2 1/2"
2 1/2"	5 5/8"	7 5/8"	2 1/2"
3"	7 1/2"	8 3/8"	2 1/2"
4"	8 1/2"	10 3/8"	2 5/8"

MegaPress Rings with V2/V3 Actuator Clearance

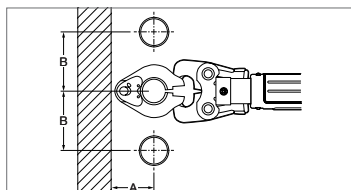

Pipe Diameter	A minimum	B minimum
1 1/4"	3 3/4"	4 7/8"
1 1/2"	4"	5 1/8"
2"	4"	5 3/8"
2 1/2"	4 1/2"	5 7/8"
3"	4 3/4"	6 3/4"
4"	5 3/8"	8 1/4"

MegaPress Rings with V2/V3 Actuator Clearance Between Pipe, Wall, and Floor

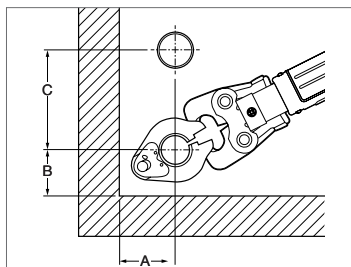

Pipe Diameter	A minimum	B minimum	C minimum
1 1/4"	3 3/4"	4 7/8"	3 3/4"
1 1/2"	4"	5 1/8"	4"
2"	4"	5 3/8"	4"
2 1/2"	4 1/2"	4"	5 7/8"
3"	4 3/4"	4 3/4"	6 3/4"
4"	5 3/8"	5 1/2"	8 1/4"

Pressing with Ring and Actuator in Tight Quarters

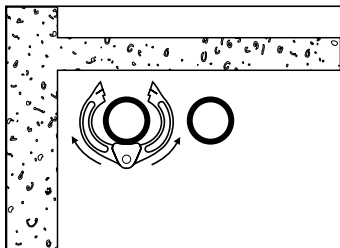

1. Wrap the actuator ring around the press fitting with the opening facing away from you.

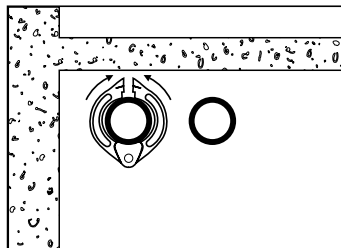

2. Close the actuator tight around the fitting.

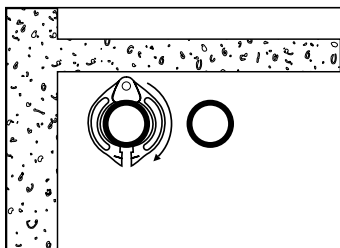

3. Rotate the actuator ring until the press jaw receptacle is facing toward you.

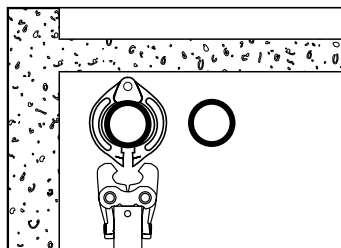

4. Properly insert press jaws and begin the press fitting procedure.

Dimensional Documentation
MegaPress Fittings



MegaPress 90° Elbow, Carbon Steel, P x P - Models 4816 / 5916 / 6616

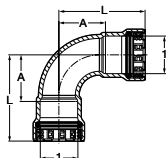

Part No.			Size (in)	A (in)	L (in)
EPDM	FKM	HNBR	1		
25200	84305	25201	1/2	1.17	2.24
25205	84310	25206	3/4	1.36	2.52
25210	84315	25211	1	1.72	3.07
25215	84320	25216	1 1/4	2.00	3.82
25220	84325	25221	1 1/2	2.26	4.13
25225	84330	25226	2	2.80	4.78

Viega MegaPress 90° Elbow P x P - Models 4816XL / 6616XL

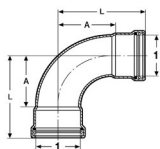

Part No.		Size (in)	A (in)	L (in)
FKM	HNBR	1		
26500	28600	2 1/2	4.15	5.94
26505	28605	3	4.76	7.09
26510	28610	4	6.00	9.17

MegaPress 90° Elbow, Carbon Steel, P x FTG - Models 4816.1 / 5916.1 / 6616.1

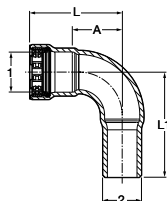

Part No.			Size (in)	A (in)	L (in)	L1 (in)
EPDM	FKM	HNBR	1 2			
26050	84875	26051	1/2 x 1/2	1.17	2.24	2.56
26055	84880	26056	3/4 x 3/4	1.36	2.52	2.87
26060	84885	26061	1 x 1	1.72	3.07	3.39
26065	84890	26066	1 1/4 x 1 1/4	2.00	3.82	4.04
26070	84895	26071	1 1/2 x 1 1/2	2.26	4.13	4.21
26075	84900	26076	2 x 2	2.80	4.78	5.08

Viega MegaPress 90° Street Elbow P x FTG - Models 4816.1XL / 6616.1XL

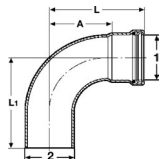

Part No.		Size (in)	A (in)	L (in)	L1 (in)
FKM	HNBR	1 2			
26515	28615	2 1/2 x 2 1/2	4.15	5.94	6.06
26520	28620	3 x 3	4.76	7.09	6.81
26525	28625	4 x 4	6.00	9.17	8.78

MegaPress 45° Elbow, Carbon Steel, P x P - Models 4826 / 5926 / 6626

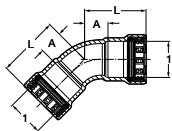

Part No.			Size (in)	A (in)	L (in)
EPDM	FKM	HNBR	1		
25230	84335	25231	1/2	0.60	1.67
25235	84340	25236	3/4	0.71	1.87
25240	84345	25241	1	0.86	2.20
25245	84350	25246	1 1/4	0.98	2.80
25250	84355	25251	1 1/2	1.12	2.99
25255	84360	25256	2	1.32	3.31

Viega MegaPress 45° Elbow P x P - Models 4826XL / 6626XL

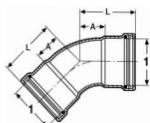

Part No.		Size (in)	A (in)	L (in)
FKM	HNBR	1		
26530	28630	2 1/2	2.10	3.90
26535	28635	3	2.26	4.56
26540	28640	4	2.74	5.92

MegaPress 45° Elbow, Carbon Steel, P x FTG - Models 4826.1 / 5926.1 / 6626.1

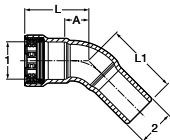

Part No.			Size (in)	A (in)	L (in)	L1 (in)
EPDM	FKM	HNBR	1 2			
26100	84905	26101	1/2 x 1/2	0.60	1.67	1.97
26105	84910	26106	3/4 x 3/4	0.71	1.87	2.13
26110	84915	26111	1 x 1	0.86	2.20	2.52
26115	84920	26116	1 1/4 x 1 1/4	0.98	2.80	2.99
26120	84925	26121	1 1/2 x 1 1/2	1.12	2.99	3.07
26125	84930	26126	2 x 2	1.32	3.31	3.58

Viega MegaPress 45° Street Elbow P x FTG - Models 4826.1XL / 6626.1XL

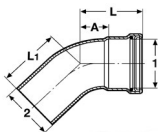

Part No.		Size (in)	A (in)	L (in)	L1 (in)
FKM	HNBR	1 2			
26545	28645	2 1/2 x 2 1/2	2.10	3.90	3.95
26550	28650	3 x 3	2.26	4.56	4.34
26555	28655	4 x 4	2.74	5.92	5.62

MegaPress Tee, Carbon Steel, P x P x P - Models 4818 / 5918 / 6618

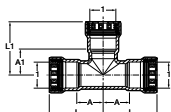

Part No.			Size (in)	A (in)	A1 (in)	L (in)	L1 (in)
EPDM	FKM	HNBR	1				
25300	84365	25301	½	0.97	0.93	2.04	2.00
25305	84370	25306	¾	1.11	1.09	2.26	2.24
25310	84375	25311	1	1.23	1.23	2.57	2.57
25315	84395	25316	1¼	1.41	1.38	3.23	3.20
25320	84400	25321	1½	1.57	1.54	3.44	3.41
25325	84405	25326	2	1.81	1.80	3.80	3.79

Viega MegaPress Tee P x P x P - Models 4818XL / 6618XL

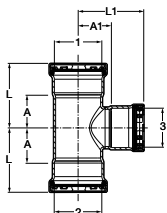

Part No.		Size (in)	A (in)	A1 (in)	L (in)	L1 (in)
FKM	HNBR	1 2 3				
NA	28910	2½ x 2½ x 1	1.35	2.04	3.15	3.38
NA	28905	2½ x 2½ x 1¼	1.72	2.06	3.52	3.87
26575	28675	2½ x 2½ x 1½	1.72	2.08	3.52	3.95
26580	28680	2½ x 2½ x 2	2.16	2.05	3.96	4.04
26560	28660	2½ x 2½ x 2½	2.16	2.26	3.96	4.06
26595	28695	3 x 3 x 1¼	1.70	2.31	4.04	4.13
26590	28690	3 x 3 x 1½	1.80	2.33	4.13	4.20
26585	28685	3 x 3 x 2	2.11	2.30	4.41	4.29
26600	28700	3 x 3 x 2½	2.32	2.51	4.63	4.31
26565	28665	3 x 3 x 3	2.55	2.52	4.88	4.82
26605	28705	4 x 4 x 1½	1.86	2.90	5.04	4.77
26610	28710	4 x 4 x 2	2.18	2.87	5.35	4.86
26615	28715	4 x 4 x 2½	2.40	3.08	5.55	4.88
26620	28720	4 x 4 x 3	2.66	3.13	5.81	5.43
26570	28670	4 x 4 x 4	3.22	3.08	6.40	6.26

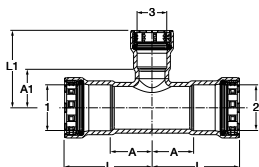
MegaPress Reducing Tee, Carbon Steel, P x P x P - Models 4818 / 5918 / 6618

EPDM	Part No.			Size (in)			A (in)	A1 (in)	L (in)	L1 (in)
	FKM	HNBR		1	2	3				
25330	84410	25331		¾	¾	½	1.11	1.07	2.26	2.14
25335	84415	25336		1	1	½	1.23	1.20	2.57	2.28
25340	84420	25341		1	1	¾	1.23	1.24	2.57	2.40
25510	84380	25491		1¼	1¼	½	1.41	1.35	3.23	2.42
25515	84385	25496		1¼	1¼	¾	1.41	1.39	3.23	2.55
25350	84390	25351		1¼	1¼	1	1.41	1.38	3.23	2.73
25360	84425	25361		1½	1½	½	1.57	1.44	3.44	2.51
25365	84430	25366		1½	1½	¾	1.57	1.48	3.44	2.64
25370	84435	25371		1½	1½	1	1.57	1.48	3.44	2.83
25375	84440	25376		1½	1½	1¼	1.57	1.50	3.44	3.32
25380	84445	25381		2	2	½	1.81	1.74	3.80	2.81
25385	84450	25386		2	2	¾	1.81	1.80	3.80	2.95
25390	84455	25391		2	2	1	1.81	1.75	3.80	3.10
25395	84460	25396		2	2	1¼	1.81	1.78	3.80	3.60
25400	84465	25401		2	2	1½	1.81	1.84	3.80	3.71

MegaPress Reducing Tee, Carbon Steel, P x P x FPT - Models 4817.2 / 5917.2 / 6617.2

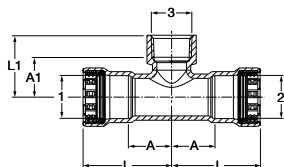

Part No.			Size (in)			A (in)	A1 (in)	L (in)	L1 (in)
EPDM	FKM	HNBR	1	2	3				
25405	84545	25406	¾ x ¾ x ½			1.11	1.02	2.26	1.55
25480	84550	25481	¾ x ¾ x ¾			1.11	1.03	2.26	1.58
25410	84555	25411	1 x 1 x ½			1.23	1.19	2.57	1.73
25415	84560	25416	1 x 1 x ¾			1.23	1.18	2.57	1.73
25485	84575	25486	1¼ x 1¼ x ½			1.41	1.31	3.23	1.85
25505	84570	25506	1¼ x 1¼ x ¾			1.41	1.33	3.23	1.89
25500	84565	25501	1¼ x 1¼ x 1			1.41	1.37	3.23	2.03
25435	84580	25436	1½ x 1½ x ½			1.57	1.42	3.44	1.95
25440	84585	25441	1½ x 1½ x ¾			1.57	1.41	3.44	1.97
25445	84590	25446	1½ x 1½ x 1			1.57	1.57	3.44	2.24
25450	NA	25451	1½ x 1½ x 1¼			1.57	1.47	3.44	2.15
25455	84595	25456	2 x 2 x ½			1.81	1.70	3.80	2.24
25460	84600	25461	2 x 2 x ¾			1.81	1.72	3.80	2.28
25465	84605	25466	2 x 2 x 1			1.81	1.89	3.80	2.55
25470	NA	25471	2 x 2 x 1¼			1.81	1.77	3.80	2.45
25475	NA	25476	2 x 2 x 1½			1.81	1.73	3.80	2.41

Viega MegaPress Tee P x P x FPT - Models 4817.2XL / 6617.2XL

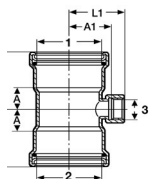

Part No.			Size (in)			A (in)	A1 (in)	L (in)	L1 (in)
FKM	HNBR		1	2	3				
26625	28725		2½ x 2½ x ¾			1.35	2.00	3.15	2.55
26630	28730		3 x 3 x ¾			1.44	2.24	3.74	2.80
26635	28735		4 x 4 x ¾			1.55	2.76	4.72	3.31

MegaPress Adapter, Carbon Steel, P x MPT - Models 4811 / 5911 / 6611

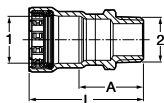

EPDM	Part No.		Size (in)		A (in)	L (in)
	FKM	HNBR	1	2		
25100	84245	25101	½ x ½		1.45	2.52
25105	84250	25106	¾ x ¾		1.50	2.66
25110	84255	25111	1 x 1		1.66	3.00
25115	84260	25116	1¼ x 1¼		1.90	3.70
25120	84265	25121	1½ x 1½		1.93	3.80
25125	84270	25126	2 x 2		1.93	3.92

Viega MegaPress Adapter P x MPT - Models 4811XL / 6611XL

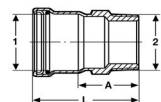

FKM	Part No.		Size (in)		A (in)	L (in)
	HNBR		1	2		
26640	28740		2½ x 2½		2.75	4.55
26645	28745		3 x 3		2.89	5.20
26650	28750		4 x 4		3.03	6.21

MegaPress Adapter, Carbon Steel, P x FPT - Models 4812 / 5912 / 6612

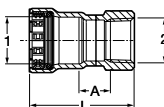

EPDM	Part No.		Size (in)		A (in)	L (in)
	FKM	HNBR	1	2		
25130	84275	25131	½ x ½		0.69	2.29
25135	84280	25136	¾ x ¾		0.74	2.45
25140	84285	25141	1 x 1		0.73	2.74
25145	84290	25146	1¼ x 1¼		0.77	3.27
25150	84295	25151	1½ x 1½		0.72	3.28
25155	84300	25156	2 x 2		0.76	3.44

Viega MegaPress Adapter P x FPT - Models 4812XL / 6612XL

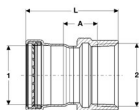

FKM	Part No.		Size (in)		A (in)	L (in)
	HNBR		1	2		
26655	28755		2½ x 2½		1.13	3.86
26660	28760		3 x 3		1.17	4.49
26665	28765		4 x 4		1.15	5.42

MegaPress Reducing Adapter, Carbon Steel, P x FPT - Models 4812 / 5912 / 6612

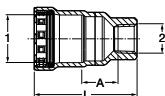

EPDM	Part No.		Size (in)		A (in)	L (in)
	FKM	HNBR	1	2		
25575	84750	25576	¾ x ½		0.73	2.43
25580	84755	25581	1 x ½		1.03	2.91
25585	84760	25586	1 x ¾		0.78	2.68
25590	84765	25591	1¼ x ½		1.15	3.50
25595	84770	25596	1¼ x ¾		1.11	3.48
25600	84775	25601	1¼ x 1		0.76	3.24
25605	84780	25606	1½ x ½		1.31	3.72
25610	84785	25611	1½ x ¾		1.27	3.70
25615	84790	25616	1½ x 1		1.11	3.64
25620	84795	25621	1½ x 1¼		0.86	3.41
25625	NA	25626	2 x ½		1.56	4.06
25630	84800	25631	2 x ¾		1.54	4.08
25635	84805	25636	2 x 1		1.35	4.00
25640	NA	25641	2 x 1¼		1.28	3.93
25645	84810	25646	2 x 1½		1.03	3.70

MegaPress Coupling with Stop, Carbon Steel, P x P - Models 4815 / 5915 / 6615

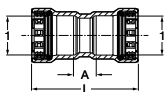

EPDM	Part No.		Size (in)	A (in)	L (in)
	FKM	HNBR	1		
25000	84215	25001	½	0.56	2.70
22005	84220	22009	¾	0.63	2.94
25010	84225	25011	1	0.59	3.29
25015	84230	25016	1¼	0.70	4.34
25020	84235	25021	1½	0.89	4.63
25025	84240	25026	2	0.77	4.75

Viega MegaPress Coupling with Stop P x P - Models 4815XL / 6615XL

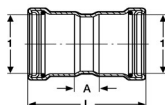

FKM	Part No.		Size (in)	A (in)	L (in)
	HNBR	1			
26670	28770	21½	1.32	4.92	
26675	28775	3	1.38	5.98	
26680	28780	4	1.57	7.87	

MegaPress Coupling No Stop, Carbon Steel, P x P - Models 4815.5 / 5915.5 / 6615.5

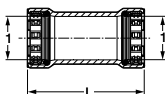

EPDM	Part No.		Size (in)	L (in)
	FKM	HNBR	1	
25030	84130	25031	½	2.71
25035	84135	25036	¾	2.94
25040	84140	25041	1	3.29
25045	84145	25046	1¼	4.34
25050	84150	25051	1½	4.63
25055	84155	25056	2	4.74

Viega MegaPress Coupling No Stop P x P - Models 4815.5XL / 6615.5XL

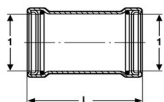

Part No.		Size (in)	L (in)
FKM	HNBR	1	
26685	28785	2½	4.92
26690	28790	3	5.98
26695	28795	4	7.91

MegaPress Extended No Stop Coupling, Carbon Steel, P x P - Models 4815.3 / 6615.3



Part No.		Size (in)	L (in)
EPDM	HNBR	1	
25070	25071	½	3.82
25075	25076	¾	4.00
25080	25081	1	4.38
25085	25086	1¼	5.33
25090	25091	1½	5.44
25095	25096	2	5.63

MegaPress Reducer, Carbon Steel, FTG x P - Models 4815.1 / 5915.1 / 6615.1

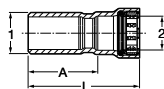

EPDM	Part No.		Size (in)	A (in)	L (in)
	FKM	HNBR	1 2		
26000	84160	26001	¾ x ½	1.78	2.85
26005	84165	26006	1 x ½	2.14	3.21
26010	84170	26011	1 x ¾	2.09	3.24
NA	84175	NA	1¼ x ¾	2.81	3.97
26015	84180	26016	1¼ x 1	2.63	3.98
26020	84185	26021	1½ x ¾	2.98	4.13
26025	84190	26031	1½ x 1	2.81	4.16
26030	84195	26026	1½ x 1¼	2.70	4.52
26035	84200	26036	2 x 1	3.14	4.49
26040	84205	26041	2 x 1¼	3.02	4.83
26045	84210	26046	2 x 1½	2.96	4.83

Viega MegaPress Reducer FTG x P - Models 4815.1XL / 6615.1XL

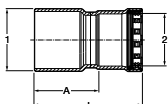

Part No.		Size (in)		A (in)	L (in)
FKM	HNBR	1	2		
26700	28800	2½ x 1		3.49	4.83
26705	28805	2½ x 1¼		3.37	5.19
26710	28810	2½ x 1½		3.30	5.17
26715	28815	2½ x 2		2.97	4.96
26720	28820	3 x 1¼		4.16	5.98
26725	28825	3 x 1½		4.08	5.95
26730	28830	3 x 2		3.76	5.75
26735	28835	3 x 2½		3.75	5.55
26740	28840	4 x 1½		5.60	7.47
26745	28845	4 x 2		5.28	7.27
26750	28850	4 x 2½		5.27	7.06
26755	28855	4 x 3		5.03	7.33

MegaPress Reducer, Carbon Steel, P x P - Models 4815.2 / 6615.2

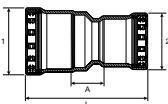

Part No.		Size (in)		A (in)	L (in)
EPDM	HNBR	1	2		
25930	25931	¾ x ½		1.20	3.43
25935	25936	1 x ½		1.37	3.79
25940	25941	1 x ¾		1.24	3.74
25945	25946	1¼ x ¾		1.40	4.37
25950	25951	1¼ x 1		1.23	4.39
25955	25956	1½ x 1¼		1.21	4.90
25960	25961	2 x 1¼		1.45	5.27
25965	25966	2 x 1½		1.43	5.26

MegaPress Union, Carbon Steel, P x P - Model 4860 / 5960

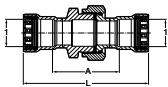

Part No.		Size (in)	A (in)	L (in)
EPDM	FKM	1		
25700	84815	½	2.35	4.50
25705	84820	¾	2.67	4.99
25710	84825	1	2.65	5.34
25715	84830	1¼	2.84	6.48
25720	84835	1½	2.89	6.63
25725	84840	2	3.92	7.89

MegaPress Union, Carbon Steel, P x P - Model 6660

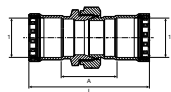

Part No.	Size (in)	A (in)	L (in)
HNBR	1		
25701	1/2	2.33	4.47
25706	3/4	2.67	4.98
25711	1	2.60	5.29
25716	1 1/4	2.85	6.49
25721	1 1/2	2.90	6.64
25726	2	3.41	7.35

MegaPress Union, Carbon Steel, P x FPT - Model 4862

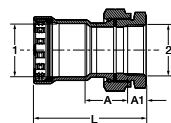

Part No.	Size (in)	A (in)	A1 (in)	L (in)
EPDM	1 2			
25650	1/2 x 1/2	1.25	0.54	2.85
25655	3/4 x 3/4	1.48	0.56	3.20
25660	1 x 1	1.37	0.66	3.38
25665	1 1/4 x 1 1/4	1.53	0.68	4.03
25670	1 1/2 x 1 1/2	1.55	0.68	4.10
25675	2 x 2	2.33	0.70	5.00

MegaPress Union, Carbon Steel, P x FPT - Model 6662

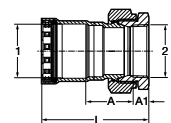

Part No.	Size (in)	A (in)	A1 (in)	L (in)
HNBR	1 2			
25651	1/2 x 1/2	1.38	0.54	2.98
25656	3/4 x 3/4	1.64	0.56	3.35
25661	1 x 1	1.62	0.66	3.63
25666	1 1/4 x 1 1/4	1.85	0.68	4.35
25671	1 1/2 x 1 1/2	1.80	0.68	4.35
25676	2 x 2	2.11	0.70	4.77

Viega MegaPress Adapter Flange P - Models 4859XL / 6659XL

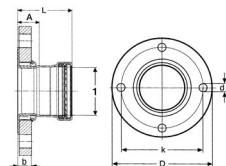

Part No.	Size (in)	A (in)	L (in)	b (in)	k (in)	D (in)	d (in)	
FKM	HNBR	1						
26775	28875	2 1/2	1.54	3.33	0.89	5.51	7.09	0.75
26780	28880	3	1.65	3.95	0.96	5.98	7.48	0.75

Viega MegaPress Adapter Flange P - Models 4859XL / 6659XL

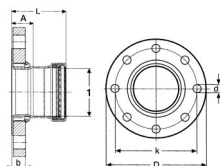

Part No.			Size (in)	A (in)	L (in)	b (in)	k (in)	D (in)	d (in)
FKM	HNBR		1						
26785	28885		4	1.63	4.80	0.96	7.52	9.06	0.75

MegaPress Flange, Carbon Steel, P x BP - Models 4859.5 / 5959.5 / 6659.5

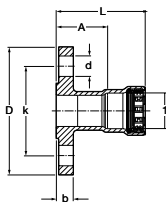

Part No.			Size (in)	A (in)	L (in)	b (in)	k (in)	D (in)	d (in)
EPDM	FKM	HNBR	1						
25760	84845	25761	1/2	1.51	2.58	0.46	2.36	3.54	0.63
25765	84850	25766	3/4	1.58	2.74	0.52	2.76	3.94	0.63
25770	84855	25771	1	1.75	3.10	0.58	3.11	4.33	0.63
25775	84860	25776	1 1/4	1.89	3.71	0.64	3.50	4.53	0.63
25780	84865	25781	1 1/2	2.06	3.93	0.70	3.86	4.92	0.63
25785	84870	25786	2	2.07	4.06	0.77	4.76	5.91	0.75

MegaPress Cap, Carbon Steel, P x Cap - Models 4856 / 5956 / 6656

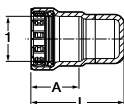

Part No.			Size (in)	A (in)	L (in)
EPDM	FKM	HNBR	1		
25730	84100	25731	1/2	1.07	2.14
25735	84105	25736	3/4	1.16	2.26
25740	84110	25741	1	1.35	2.43
25745	84115	25746	1 1/4	1.82	2.93
25750	84120	25751	1 1/2	1.87	3.02
25755	84125	25756	2	1.99	3.11

Viega MegaPress Cap P - Models 4856.1XL / 6656.1XL

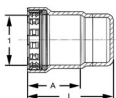

Part No.		Size (in)	A (in)	L (in)
FKM	HNBR	1		
26760	28860	2½	1.80	3.27
26765	28865	3	2.30	3.78
26770	28870	4	3.18	4.65

MegaPress 3-Piece Ball Valve, Carbon Steel, P x P - Models 4875.8 / 5975.8

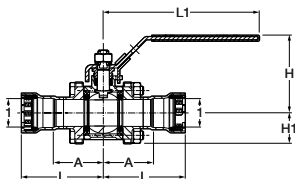

Part No.		Size (in)*	A (in)	L (in)	L1 (in)	H (in)	H1 (in)
EPDM	FKM	1					
28500	86400	½	1.72	2.80	5.88	2.85	1.04
28501	86405	¾	1.91	3.06	5.88	2.93	1.16
28502	86410	1	2.19	3.54	7.54	3.33	1.40
28503	86415	1¼	2.50	4.31	7.54	3.57	1.57
28504	86420	1½	2.92	4.79	7.54	3.89	1.83
28505	86425	2	3.09	5.07	7.54	3.89	1.83

Q How would an inspector know they are looking at a good connection?

A Good connections can be proven by performing a pressure test. This is the same procedure for threaded systems.

Q What steel pipe schedules can Viega MegaPress be installed with?

A Viega MegaPress may be installed with schedule 5 to schedule 40 ASTM A53, ASTM A795, or ASTM A135 black steel pipe. National codes require the use of schedule 10 and schedule 40 ASTM A53 black steel pipe for fuel gas applications. All applications must be compliant with local code requirements.

Q Do I have to lubricate the pipe or the fitting?

A No, Viega does not require lubrication of the pipe or the fitting.

Q Can I install Viega MegaPress fittings on epoxy coated pipe?

A Yes, the surface of the pipe must be smooth before installing the fittings. Surface smoothing can be accomplished by using the RIDGID Pipe Prep tool or an abrasive sanding cloth.

Q Is Viega MegaPress approved for underground installation?

A Yes, Viega MegaPress systems may be installed underground but must be protected per the national codes and the local authority.

Q What is the procedure for welding near a Viega MegaPress fitting?

A When welding adjacent to a Viega MegaPress fitting, a minimum four inches of space should be allowed to avoid overheating and damaging the sealing element. When welding a fitting in line with a Viega MegaPress fitting, a minimum distance of three feet should be maintained. The Viega MegaPress fitting should also be protected from overheating through use of a cooling agent or welding blanket.

Q Can Viega MegaPress fittings be installed in a potable water application?

A No, Viega MegaPress is not certified for potable water usage.

Q Can Viega MegaPress fittings be installed in a natural gas application?

A Only Viega MegaPressG with HNBR sealing elements are certified by CSA to be installed in natural gas applications.

Q What is the maximum temperature that Viega MegaPressG, with HNBR sealing elements, can be exposed to?

A Viega MegaPressG has been certified by CSA LC4 to withstand 1,000°F for one hour.

Q What is Smart Connect technology?

A Smart Connect technology provides a quick and easy way to identify unpressed connections during the pressure testing process. Unpressed connections are located by pressurizing the system with air or water. When testing with air or water, the pressure range is 15 psi to 85 psi maximum. The flow path is removed during the pressing process, creating a leak-proof, reliable connection. Guaranteed.

Q Why is Smart Connect technology so valuable?

A Smart Connect technology provides the user with a strong peace of mind. It allows for faster testing procedures since you do not have to shut down and drain the system. Costly damages and possible insurance claims and premiums can be avoided because it identifies unpressed connections before they can become a problem. Because of the time savings, projects stay on track.

Viega MegaPress Limited Warranty

Subject to the conditions and limitations in this Limited Warranty, Viega LLC (Viega) warrants to end users, installers, and distribution houses that its Viega MegaPress metal press fittings including MegaPress, MegaPress FKM, MegaPress 304 FKM, MegaPress 316, and MegaPress 316 FKM (Viega Product) with application appropriate sealing element when properly installed in non-industrial and non-marine applications and under specified operating conditions of use shall be free from failure caused by manufacturing defects for a period of fifteen (15) years from date of installation. MegaPress valves, when properly installed and under normal conditions of use, will be free of failure from manufacturing defects for a period of two (2) years from date of installation.

Under this Limited Warranty, you only have a right to a remedy if the failure or leak resulted from a manufacturing defect in the Viega Product and the failure or leak occurs during the warranty period. You do not have a remedy under this warranty and the warranty remedy does not apply if the failure or any resulting damage is caused by (1) components other than those manufactured or sold by Viega, such as black iron pipe; (2) not designing, installing, inspecting, testing, or maintaining the Viega Product in accordance with Viega's installation and product instructions in effect at the time of installation and other specifications and approvals applicable to the installation; (3) use of Viega Product under non recommended system operating conditions, improper handling and protection of the Viega Product prior to, during and after installation, inadequate freeze protection, or exposure to environmental conditions not recommended for the application; or (4) acts of nature, such as, but not limited to, earthquakes, fire, or weather damage. In the event of a leak or other failure of the Viega Product covered by this warranty, it is the responsibility of the end user to take appropriate measures to mitigate any damage, to include making timely repairs. Only if the warranty applies will Viega be responsible for the remedy under this warranty. The part or parts which you claim failed should be kept and Viega contacted by writing to the address below

or telephoning 1-800-976-9819 within thirty (30) calendar days after the leak or other failure and identifying yourself as having a warranty claim. You should be prepared to ship, at your expense, the product which you claim failed due to a manufacturing defect, document the date of installation, and the amount of the repair or replacement if performed by you. Within a reasonable time after receiving the product, Viega will investigate the reasons for the failure, which includes the right to inspect the product at a Viega location and reasonable access to the site of damage. Viega will notify you in writing as to the results of its review.

In the event that Viega determines that the failure or leak was the result of a manufacturing defect in the Viega Product covered by this warranty and this warranty applies, the **EXCLUSIVE AND ONLY REMEDY** under this warranty shall be the reimbursement for reasonable charges for repair or replacement of the Viega Product itself. **VIEGA SHALL NOT BE LIABLE FOR ANY CONSEQUENTIAL OR OTHER DAMAGE (FOR EXAMPLE, ECONOMIC LOSS, WATER OR PROPERTY OR MOLD REMEDIATION) UNDER ANY LEGAL THEORY AND WHETHER ASSERTED BY DIRECT ACTION, FOR CONTRIBUTION OR INDEMNITY OR OTHERWISE.**

THE ABOVE WARRANTY IS IN LIEU OF ALL OTHER WARRANTIES, EXPRESS OR IMPLIED, INCLUDING, BUT NOT LIMITED TO, THE IMPLIED WARRANTIES OF MERCHANTABILITY AND FITNESS FOR A PARTICULAR PURPOSE OR ANY STATUTE OF LIMITATIONS RELATING TO SUCH WARRANTIES. Other than this Limited Warranty, Viega does not authorize any person or firm to create for it any other obligation or liability in connection with its products.

This Limited Warranty gives you specific legal rights and you also may have other rights which may vary from state to state. This warranty shall be interpreted and applied under the law of the state in which the product is installed and is intended as a **COMMERCIAL WARRANTY**.

Viega MegaPressG Limited Warranty

Subject to the conditions and limitations in this Limited Warranty, Viega LLC (Viega) warrants to end users, installers, and distribution houses that its Viega MegaPressG metal press fittings (Viega Product) with application appropriate sealing element when properly installed in non-industrial and non-marine applications and Viega MegaPressG Approved Applications for natural and fuel gases and lubricant, and approved fuels, lubricants, and oils, under Viega specified system operating conditions, shall be free from failure caused by manufacturing defects for a period of fifteen (15) years from date of installation. MegaPressG Valves, when properly installed and under normal conditions of use, will be free of failure from manufacturing defects for a period of two (2) years from date of installation.

Under this Limited Warranty, you only have a right to a remedy if the failure or leak resulted from a manufacturing defect in the Viega Product and the failure or leak occurs during the warranty period. You do not have a remedy under this warranty and the warranty remedy does not apply if the failure or any resulting damage is caused by (1) components other than those manufactured or sold by Viega, such as black iron pipe; (2) not designing, installing, inspecting, testing, or maintaining the Viega Product in accordance with Viega's installation and product instructions in effect at the time of installation and other specifications and approvals applicable to the installation; (3) use of Viega Product under non recommended system operating conditions, improper handling and protection of the Viega Product prior to, during and after installation, inadequate freeze protection, or exposure to environmental conditions not recommended for the application; or (4) acts of nature, such as, but not limited to, earthquakes, fire, or weather damage. In the event of a leak or other failure of the Viega Product covered by this warranty, it is the responsibility of the end user to take appropriate measures to mitigate any damage, to include making timely repairs. Only if the warranty applies will Viega be responsible for the remedy under this warranty. The part or parts which you claim failed should be kept and

Viega contacted by writing to the address below or telephoning 1-800-976-9819 within thirty (30) calendar days after the leak or other failure and identifying yourself as having a warranty claim. You should be prepared to ship, at your expense, the product which you claim failed due to a manufacturing defect, document the date of installation, and the amount of the repair or replacement if performed by you. Within a reasonable time after receiving the product, Viega will investigate the reasons for the failure, which includes the right to inspect the product at a Viega location and reasonable access to the site of damage. Viega will notify you in writing as to the results of its review.

In the event that Viega determines that the failure or leak was the result of a manufacturing defect in the Viega Product covered by this warranty and this warranty applies, the **EXCLUSIVE AND ONLY REMEDY** under this warranty shall be the reimbursement for reasonable charges for repair or replacement of the Viega Product itself. **VIEGA SHALL NOT BE LIABLE FOR ANY CONSEQUENTIAL OR OTHER DAMAGE (FOR EXAMPLE, ECONOMIC LOSS, WATER OR PROPERTY OR MOLD REMEDIATION) UNDER ANY LEGAL THEORY AND WHETHER ASSERTED BY DIRECT ACTION, FOR CONTRIBUTION OR INDEMNITY OR OTHERWISE.**

THE ABOVE WARRANTY IS IN LIEU OF ALL OTHER WARRANTIES, EXPRESS OR IMPLIED, INCLUDING, BUT NOT LIMITED TO, THE IMPLIED WARRANTIES OF MERCHANTABILITY AND FITNESS FOR A PARTICULAR PURPOSE OR ANY STATUTE OF LIMITATIONS RELATING TO SUCH WARRANTIES. Other than this Limited Warranty, Viega does not authorize any person or firm to create for it any other obligation or liability in connection with its products.

This Limited Warranty gives you specific legal rights and you also may have other rights which may vary from state to state. This warranty shall be interpreted and applied under the law of the state in which the product is installed and is intended as a **COMMERCIAL WARRANTY**.

Viega Metal Systems for Industrial Applications Limited Warranty

Industrial applications are defined as non-residential and non-commercial applications not normally accessible to the general public, including manufacturing, mining, process or fabrication environments.

Subject to the terms and conditions of this Limited Warranty, Viega LLC (Viega) warrants to end users, installers and distribution houses that its Viega metal press products (Viega product) when properly installed in industrial applications shall be free from failure caused by manufacturing defects for a period of two (2) years from date of installation.

Under this Limited Warranty, you only have a right to a remedy if the failure or leak resulted from a manufacturing defect in the Viega product and the failure or leak occurs during the warranty period. You do not have a remedy under this warranty and the warranty remedy does not apply if the failure or any resulting damage is caused by (1) components other than those sold by Viega; (2) not designing, installing, inspecting, testing, or maintaining the Viega product in accordance with Viega's installation and product instructions in effect at the time of installation and other specifications and approvals applicable to the installation; (3) improper handling and protection of the Viega product prior to, during and after installation, inadequate freeze protection, or exposure to environmental or operating conditions not recommended for the application; or (4) acts of nature, such as, but not limited to earthquakes, fire, or weather damage. Final approval as to use compatibility to a specific process or fluid application is the responsibility of the engineer of record or responsible design/facilities personnel and this Limited Warranty only applies to manufacturing defects in the Viega Product.

In the event of a leak or other failure in the Viega product covered by this warranty, it is the responsibility of the end user to take appropriate measures to diminish any damage, to include making timely repairs. Only if the warranty applies will Viega be responsible for the remedy under this warranty. The part or

parts which you claim failed should be kept and Viega contacted by writing to the address below or telephoning 1-800-976-9819 within thirty (30) calendar days after the leak or other failure and identifying yourself as having a warranty claim. You should be prepared to ship, at your expense, the product which you claim failed due to a manufacturing defect, document the date of installation, and the amount of the repair or replacement if performed by you. Within a reasonable time after receiving the product, Viega will investigate the reasons for the failure, which includes the right to inspect the product at a Viega location and reasonable access to the site of damage. Viega will notify you in writing as to the results of its review.

In the event that Viega determines that the failure or leak was the result of a manufacturing defect in the Viega Product covered by this warranty and to which this warranty applies, the EXCLUSIVE AND ONLY REMEDY under this warranty shall be the reimbursement for reasonable charges for repair or replacement of the Viega Product itself. VIEGA SHALL NOT BE LIABLE FOR CONSEQUENTIAL OR OTHER DAMAGE (FOR EXAMPLE, ECONOMIC LOSS, WATER OR PROPERTY OR MOLD REMEDIATION) UNDER ANY LEGAL THEORY AND WHETHER ASSERTED BY DIRECT ACTION, FOR CONTRIBUTION OR INDEMNITY OR OTHERWISE.

THE ABOVE WARRANTY IS IN LIEU OF ALL OTHER WARRANTIES, EXPRESS OR IMPLIED, INCLUDING, BUT NOT LIMITED TO, THE IMPLIED WARRANTIES OR ANY STATUTE OF LIMITATIONS RELATING TO SUCH WARRANTIES. Other than this Limited Warranty, Viega does not authorize any person or firm to create for it any other obligation or liability in connection with its products.

This Limited Warranty gives you specific legal rights and you also may have other rights which may vary from state to state. This warranty shall be interpreted and applied under the law of the state in which the product is installed and is intended as a Commercial Warranty.



Viega LLC

585 Interlocken Blvd
Broomfield, CO 80021

Ph: 800-976-9819
Fax: 800-976-9817
www.viega.us

