



CSI: DIVISION: 23 00 00—HEATING, VENTILATING AND AIR-CONDITIONING (HVAC)  
Section: 23 21 13—Hydronic Piping

**Product certification system:**

The ICC-ES product certification system includes testing samples taken from the market or supplier's stock, or a combination of both, to verify compliance with applicable codes and standards. The system also involves factory inspections, and assessment and surveillance of the supplier's quality system.

**Products:** Viega LLC's ProRadiant product line for use in hydronic heating/cooling systems, including but not limited to: Viega Barrier tubing, PureFlow FostaPEX® (PEX) tubing, PureFlow Press fittings, PureFlow crimp fitting and compression fittings

**Listee:** Viega LLC  
585 Interlocken Blvd  
Bloomfield, CO 80021  
[www.viega.us](http://www.viega.us)

**Compliance with the following codes:**

2021, 2018, 2015, 2012 and 2009 *International Mechanical Code®* (IMC)  
2021, 2018, 2015, 2012 and 2009 *International Residential Code®* (IRC)  
2021, 2018, 2015, 2012 and 2009 *Uniform Mechanical Code®* (UMC)\*  
2021, 2018 and 2015 *Uniform Solar Energy and Hydronic Code®* (USEHC)\*  
2019, 2016, 2013 and 2010 *California Mechanical Code* (CMC)  
2020 and 2017 *City of Los Angeles Mechanical Code*  
2017 *Massachusetts State Building Code 780 CMR Ninth Edition: Chapter 28*

\*Copyrighted publication of the International Association of Plumbing and Mechanical Officials

**Compliance with the following standards:**

ASTM F876-2020b, Standard Specification for Cross-linked Polyethylene (PEX) Tubing  
ASTM F877-2020, Standard Specification for Cross-linked Polyethylene (PEX) Plastic Hot- and Cold-Water Distribution Systems  
ASTM F3253-2019, Standard Specification for Crosslinked Polyethylene (PEX) Tubing with Oxygen Barrier for Hot- and Cold-Water Hydronic Distribution Systems  
ASTM F3347-2021, Standard Specification for Metal Press Insert Fittings with Factory Assembled Stainless Steel Press Sleeve for SDR9 Cross-linked Polyethylene (PEX) Tubing and SDR9 Polyethylene of Raised Temperature (PE-RT) Tubing  
ASTM E84-2021a, Standard Test Method for Surface Burning Characteristics of Building Materials  
NSF/ANSI 14-2020, Plastic Piping Systems Components and Related Materials  
UL/ANSI 263 (14th Edition), Safety Fire Tests for Building Construction and Materials

CAN/ULC S101(5th Edition), Standard Methods of Fire Endurance Tests for Building Construction and Materials

CAN/ULC S102.2 (8th Edition), Standard Methods for Test for Surface Burning Characteristics of Flooring, Floor Coverings, and Miscellaneous Materials and Assemblies

ICC-ES LC1004-2010, PMG Listing Criteria for PP, PEX, PEX-AL-PEX, and PP-AL-PP Piping, Tube and Fittings Used In Radiant Heating and Water Supply Systems

#### Identification:

**Tubing:** The Viega Barrier and PureFlow FostaPEX® tubing covered by this listing must be labeled at minimum intervals of 5 feet (1524 mm) with the manufacturer's name and/or trademark (Viega), product name (Viega Barrier, and PureFlow FostaPEX® tubing), nominal tubing size, standard dimension ratio (SDR 9), material designation (e.g., PEX 1006), temperature and pressure rating [160 psi at 73°F and 100 psi at 180°F], ASTM F876/F877 and ASTM F3253 designation, and the ICC-ES PMG listing mark.

**Fittings:** The Viega LLC PureFlow Press fittings covered by this listing must be labeled with the Viega trademark, nominal size, production code, and ASTM F877 and F3347 designation. Packages of fittings must bear the Viega LLC name, product name, part number and the ICC-ES PMG listing mark.

#### Installation:

**General:** Viega LLC tubing, and fittings must be manufactured, identified and installed in accordance with this listing, the applicable codes and the manufacturer's published installation instructions. Manufacturer's published installation instructions must be furnished to the code official. Installation must conform to the requirements of the applicable code and is subject to approval by the code official having jurisdiction. The outer and aluminum layers of PureFlow FostaPEX® tubing must be removed with a tool supplied by Viega LLC before a pipe/fitting joint is made. Installation and design of the heating system for each type of construction must conform to the manufacturer's instructions and Chapter 12 of the IMC or Chapter 21 of the IRC and is subject to approval by the code official. The system must be installed by Viega LLC-trained installers. Mounting brackets and installation hardware are provided by Viega LLC. Horizontally laid pipe must be secured in such a manner that temperature-induced expansion and contraction are accommodated. Minimum bending radius is 8 times the outside tube diameter of the PEX tube. The outside tube diameter is the nominal diameter plus 1/8 inch (3.2 mm). Tubing must be protected from prolonged exposure to direct sunlight or fluorescent lighting and must be protected from physical damage with an oversized sleeve at structural mass penetrations and when the tube is uncovered. Typical installation details are shown in Figures 1 – 10.

**Inspection:** The tubing must be pressure-tested for leaks before installation of covering, as noted in Chapter 12 of the IMC or Chapter 21 of the IRC, as applicable. The leak test must be witnessed by the code official or the code official's designated representative.

**Climate Panel:** Climate Panels are 1/2-inch-thick (12.7 mm) plywood panels backed by an aluminum plate designed to secure 5/16" (7.9 mm) Viega Barrier tubing at 7 inches (178 mm) on center. When the tubing is installed using Viega LLC Climate Panels on top of wood subfloors, on concrete floors, or on walls or ceilings; the Climate Panels must be installed in accordance with the manufacturer's instructions, the applicable code, and this listing.

**Climate Panel Floors:** After the panels have been laid, the tracks must be vacuumed of debris and a bead of approved silicone sealant (e.g., Viega Groove Tube heat transfer adhesive) must be placed in the track prior to installation of the PEX tubing. Batt insulation must be installed beneath the subfloor in the joist cavity. See Figures 1.

**Climate Panel Walls:** When the tubing is installed in wood-framed walls, the installation begins at floor level on the exterior wall. The Climate Panels are installed parallel to the floor, six rows high, to avoid interference with window and picture placement. The Climate Panels are screwed to the studs on both sides of the groove. One-half-inch-thick (12.7 mm) spacers must be attached to the remainder of the stud wall to provide an even base for the wall covering. See Figure 2.

**Climate Panel Ceilings:** When the tubing is installed in wood-framed ceilings, the Climate Panels are nailed or stapled in place perpendicular to the ceiling joists. The tubing is then uncoiled and pressed into place in the Climate Panels.

**Climate Trak:** Climate Traks are extruded aluminum panels designed to be secured to the underside of the subfloor. Climate Traks are mounted at spacing dependent on the radiant design and are compatible with 3/8" (9.5 mm) or 1/2" (12.7 mm) Viega Barrier tubing. After attachment to the subfloor, tubing is inserted into the channel. Insulation is installed beneath Climate Trak in the joist cavity leaving a 1-2" space between the insulation and the Climate Traks. See Figure 3.

**Heat Transfer Plate:** Heat transfer plates are a light gauge, preformed aluminum plate compatible with 3/8" (9.5 mm) or 1/2" (12.7 mm) Viega Barrier tubing depending on the model. When the tubing is located between the joists beneath a wood-framed floor, aluminum heat-emission plates can be installed over the tubing. The tubing is inserted into the plates with a bead of approved silicone sealant (e.g., Viega Groove Tube heat transfer adhesive). The plates are then stapled to the underside of the wood subfloor and insulation is installed beneath the aluminum plates Trak in the joist cavity leaving a 1-2" space between the insulation and the plates. See Figure 4.

**Common Concrete Fasteners:** Concrete system point fasteners are used when tubing is installed in a poured concrete slab to maintain tubing location during the concrete pour. Fasteners attach the tubing to insulation, wire mesh, rebar, or base slab with the appropriate fastener for the application. See Figures 5, 6, and 7.

**Rapid Grid:** Rapid Grid is an insulated panel used to attach PEX tubing to the subbase. Rapid Grid is compatible with 3/8" (9.5 mm), 1/2" (12.7 mm) and 5/8" (15.9 mm) Viega Barrier tubing and 1/2" (12.7 mm) PureFlow FostaPEX® tubing. Cover the entire slab area with Rapid Grid ensuring panels are interlocked and seams are staggered from row to row. After the floor is covered with Rapid Grid, install tubing dependent on radiant design and connect to the manifold. When installed properly Rapid Grid provides insulation value, vapor barrier, and grid fastening system. See Figure 8.

**Climate Mat:** Climate Mat is a prefabricated tubing assembly made to order and delivered in cylindrical rolls. Climate Mat is engineered for rapid installation; up to 6 circuits can be laid down at once. Climate Mat utilizes 1/2" (12.7mm) or 5/8" (15.9mm) tubing with 6", 9" or 12" center spacing. After inspection of tubing, place mats per radiant design. Secure the first spacer strip to the sub base or wire mesh (fastening methods will vary depending on the type of sub base). Unroll the mat and pull it tight ensuring that it is straight and square. Attach the last spacer strip to the sub base or wire mesh. Return and anchor each spacer strip with at least two fasteners. Run the leaders back to the manifold location and attach the tubing. Fasten the leaders to the sub base with the appropriate fastener and spacing. See Figure 9.

**Thin Slab:** Thin Slabs typically use gypsum based or a similar light weight product. Thin slabs are applied over structural slabs or subfloors. The thickness of the slab is usually less than that of a standard slab (thickness dictated by local code). When the tubing is installed in a poured gypsum underlayment or in a lightweight concrete pour over a wood subfloor, the tubing must be stapled to the wood subfloor. If applicable, insulation is installed beneath the floor in the joist cavity. See Figure 10.

**Return-air Plenums:** Combustible piping may be installed in areas required to be of noncombustible construction. The Viega Barrier and PureFlow FostaPEX® tubing products and Climate Mat were tested to ASTM E84, UL 263, ULC S101 and ULC S102.2 and were found to have a flame-spread index (FS) rating of not more than 25 and a smoke-developed index (SD) rating of not more than 50 when tested. The Viega Barrier and PureFlow FostaPEX® tubing products and Climate Mat have been evaluated for installation in either horizontal or vertical orientations in return-air plenums. Ratings apply when tubing is field insulated with fiberglass insulation meeting the following requirements: ASTM E84 Listed and having a Flame Spread Index of <25 and a Smoke Developed Index of <50, a Wall thickness of not less than 1/2" and there shall be no exposed tubing. Tubing may contain fittings which shall also be fully encased in insulation.

Clearances from heat-producing equipment must be in accordance with Chapter 5 of the *International Fuel Gas Code*®, Chapter 13 of the IRC or Chapter 8 of the IAPMO UMC, as applicable.

Models:

### **Tubing:**

General: The Viega Barrier and PureFlow FostaPEX® tubing products are manufactured from cross-linked polyethylene (PEX) materials satisfying NSF 61, NSF 14, as well as ASTM F876, F877 and F3253. Viega LLC tube and fitting products are pressure-rated for 100 psi (689 kPa) at 180°F (82°C) and has a standard dimension ratio of 9. The standard dimension ratio is the ratio of tube outside diameter to the wall thickness and is constant for all Viega LLC tube sizes.

Viega Barrier is black with a red stripe and is composed of four layers: PEX, an adhesive layer, an oxygen barrier layer, and an outer PE layer. Viega Barrier is available in 5/16-, 3/8-, 1/2-, 5/8-, 3/4-, 1-, 1 1/4-, 1 1/2-, and 2-inch (7.9, 9.5, 12.7, 15.9, 19.1, 25.4, 31.7, 38.1 and 50.8 mm) nominal diameter sizes in coils ranging from 100 to 4000 feet (30.5 m to 1220 m) in length and is also available in straight lengths of 20 feet (6.1 m).

PureFlow FostaPEX® Tubing has a fully dimensional inner layer of Viega PureFlow PEX tubing, an adhesive layer, an aluminum layer and an outer PE layer. PureFlow FostaPEX® tubing is silver or red in color and available in 1/2-, 5/8-, 3/4- and 1-inch (12.7, 15.9, 19.1, and 25.4 mm) nominal diameter sizes. Silver PureFlow FostaPEX® is available in coils ranging from 150 to 400 feet (45.8 to 122 m) in length, and in straight lengths of 20 feet (6.1 m). Red PureFlow FostaPEX® is available in 150-foot (45.8 m) coils.

### **Fittings:**

The Viega PureFlow Press fitting system is used with Viega Barrier and PureFlow FostaPEX® tubing. The outer and aluminum layers of PureFlow FostaPEX® tubing must be removed with a tool supplied by Viega LLC before a pipe/fitting joint is made. The fittings are bronze or polymer, insert-type with an external attached stainless steel press sleeve. The stainless-steel press sleeve must appropriately be pressed onto the tube and fitting with a proprietary ratchet-style tool that is supplied by Viega LLC. The tool only releases from the fitting once the full compression is exerted on the fitting. When used with the fittings noted above, Viega PureFlow Press fittings comply with ASTM F877 and F3347. The fittings are illustrated in Figure 11 and 12.

**Note:** Climate Panel, Climate Trak, Heat transfer plates, Climate Mat, and Rapid Grid are included as non-listed accessories.

Conditions of Listing:

1. Tube and fitting systems must be manufactured, identified and installed in accordance with this listing, the applicable codes and the manufacturer's published installation instructions. Tube and fittings must be installed by Viega LLC-trained installers. Manufacturer's published installation instructions must be furnished to the code official. The instructions within this listing will govern if there are any conflicts between the manufacturer's instructions and this listing.
2. Details on the design and installation of the heating system must be submitted to the code official for approval.
3. Any potable water connections must be protected against backflow from the hydronic heating system.
4. The tubing must be maintained at the greater of 1 1/2 times the working pressure or 100 psi (89.4 kPa) during placement of the concrete cover for a hydronic piping system.
5. When installation is in fire-resistance-rated assemblies, evidence of compliance with IBC Section 712 (penetrations), UBC Section 709 (walls and partitions) and UBC Section 710 (floor/ceiling or roof/ceiling), as applicable, must be provided to the code official.
6. Viega tubing and fittings must be protected from exposure to direct sunlight. Tubing and fittings must be protected from physical damage with an oversized sleeve at structural mass penetrations and when the tube is uncovered. Annular spaces between sleeves and pipes must be filled or tightly caulked in an approved manner.
7. Each installation must be pressure-tested for leaks in the presence of the code official or the code official's designated representative.
8. The use of the tubing is limited to hydronic systems using water or a mixture of water and an approved glycol as the heat transfer fluid.

9. The tubing must not be used as a source of electrical ground.
10. The minimum cold free-bending radius is eight times the outside diameter, or five times the outside diameter with use of a bend support supplied by Viega LLC. The outside diameter is the nominal diameter plus 1/8 inch (3.2 mm).
11. When the system is embedded in concrete, tubing must be covered a minimum of 3/4 inch (19.1 mm) and installation must comply with IBC Chapter 19 and comply with local code.
12. The cross-linked polyethylene tubing under quality control programs with surveillance inspections by ICC-ES.

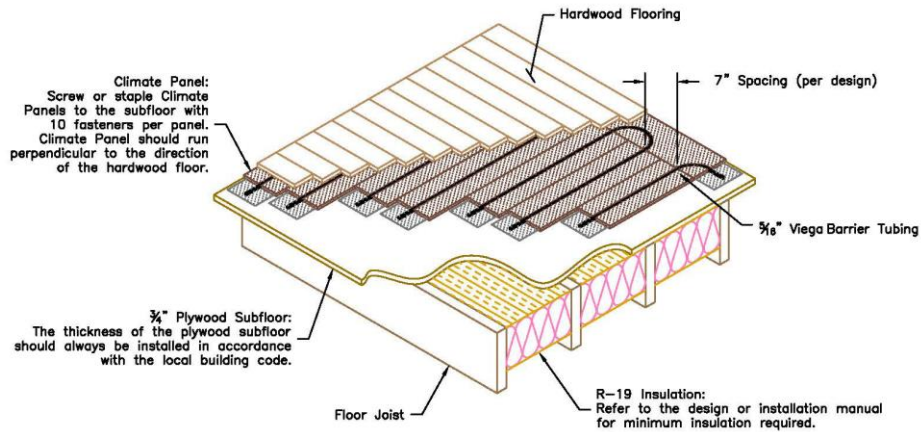

Figure 1 Climate Panel – Joist Subfloor - Hardwood

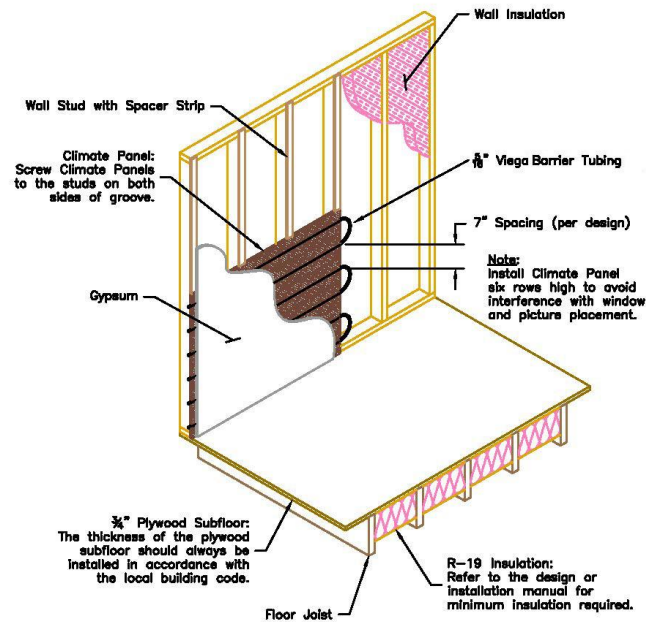

Figure 2 Climate Panel – Wall Gypsum - CP Wall Gypsum

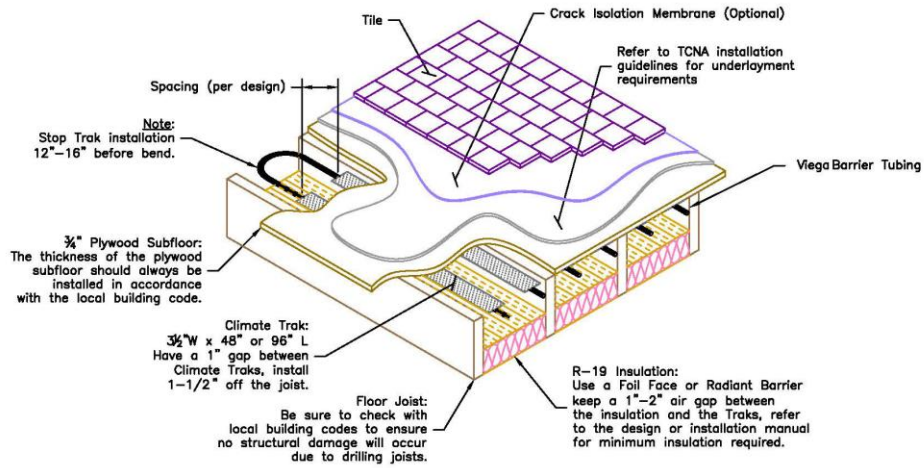

Figure 3 Climate Trak – Joist Tile

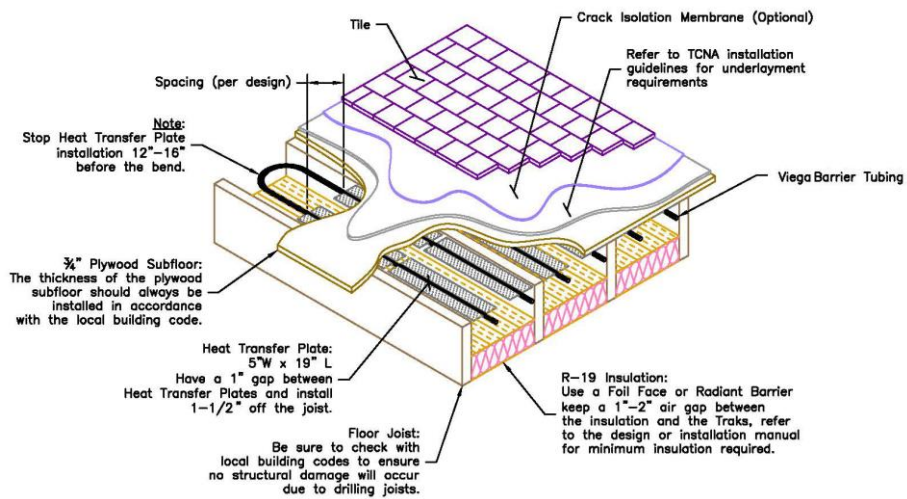

Figure 4 Heat Transfer Plate – In-Joist

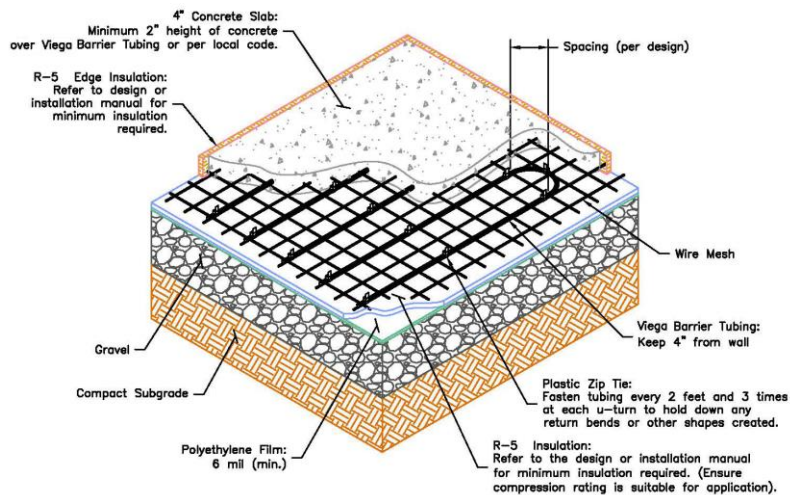

Figure 5 In-Slab – Plastic Zip Ties

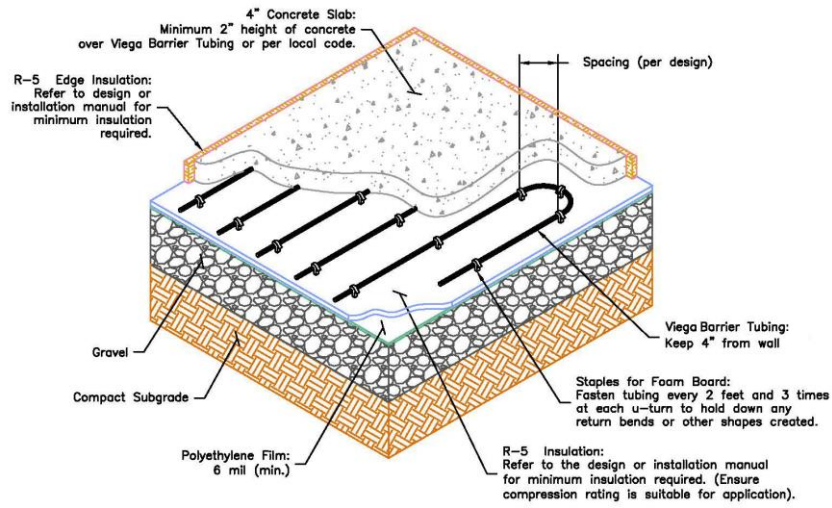

Figure 6 In-Slab – Foamboard Staples

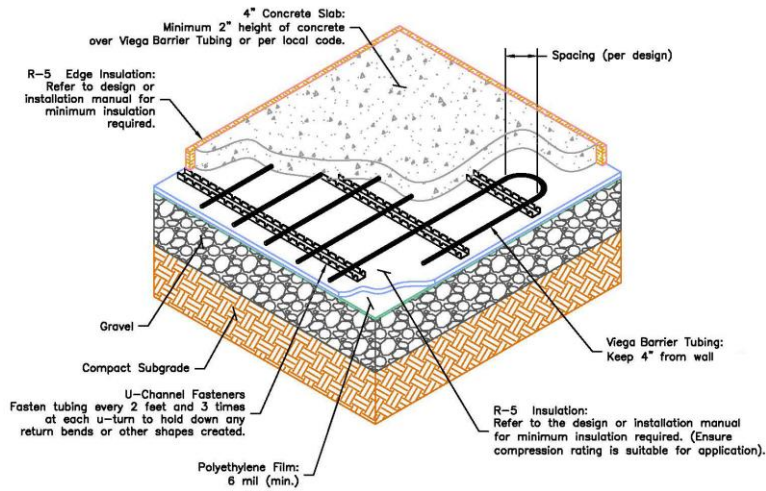

Figure 7 In-Slab – U-Channel

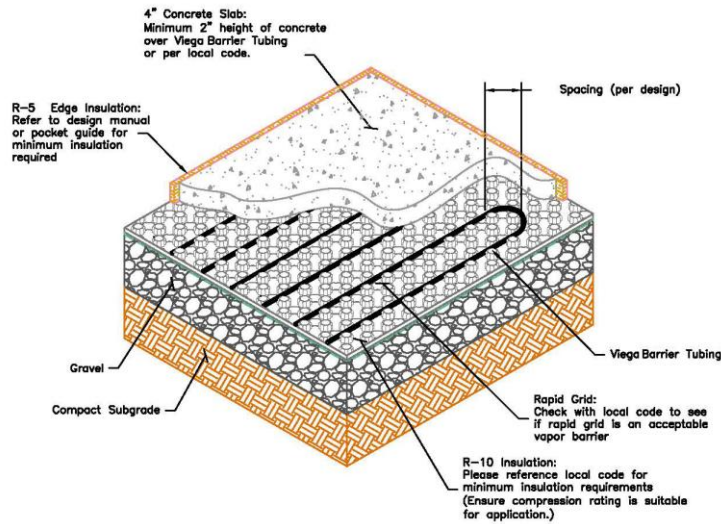

Figure 8 In-Slab – Rapid Grid

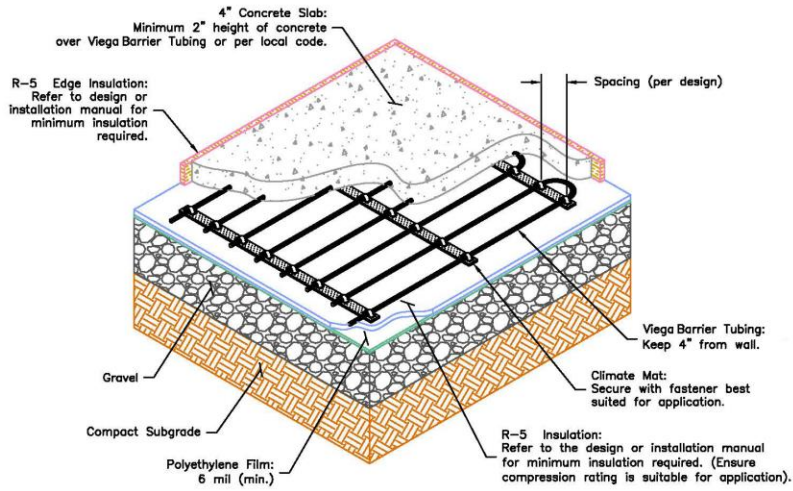

Figure 9 Climate Mat – In-Slab with Insulation

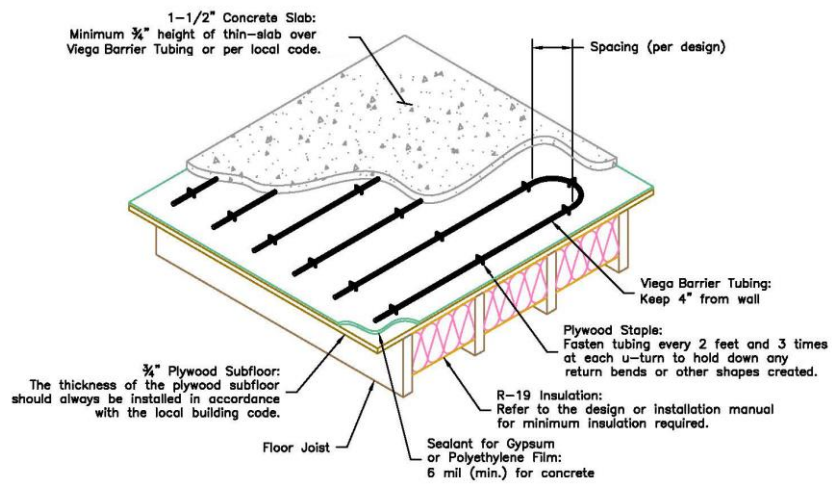

Figure 10 Thin-Slab – Plywood Staples

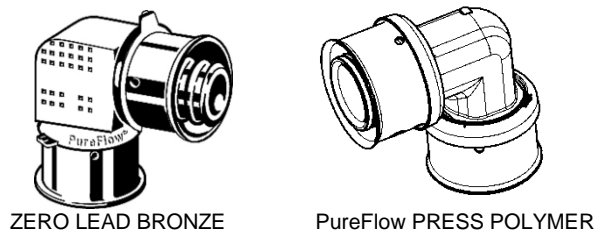
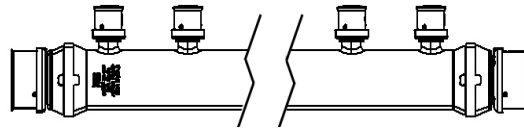
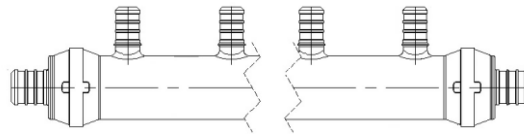

FIGURE 11  
VIEGA PureFlow PRESS FITTINGS

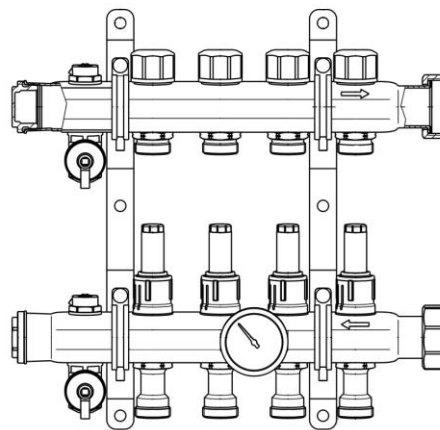



**FIGURE 12**  
**VIEGA PureFlow PRESS POLYMER MANIFOLD**



**FIGURE 13**  
**VIEGA POLYALLOY MANIFOLD**



**FIGURE 14**  
**VIEGA METAL ZONING MANIFOLDS**