

Pocket Guide

Viega PureFlow® Systems



viega

Viega...

Connected in quality

Building on Tradition

Founded 120 years ago, Viega is a privately owned, international group of companies. In the United States, Canada, Mexico, and Latin America, Viega specializes in plumbing, heating, and pipe joining technologies. The values of Viega's founder, Franz-Anselm Viegener, are just as present today as they were when he started the company in 1899. Courage, passion, and innovative spirit are still the basics of Viega's foundation.

Heritage of quality, vision for the future

Viega's heritage of superiority demands nothing but the best for our customers. Engineered to be efficient, Viega products perform at the highest possible level, providing confidence and peace of mind. Viega is the only manufacturer to offer press systems in multiple pipe joining materials. More than one million Viega press fittings are installed every day around the world and, with a Supply Chain that can process orders in 48 hours or less, Viega is positioned to provide customers with the best, most versatile support in the industry.



WARNING!

Viega products are designed to be installed by licensed and trained plumbing and mechanical professionals who are familiar with Viega products and their installation. **Installation by non-professionals may void Viega LLC's warranty.**



This document is subject to updates. For the most current Viega technical literature please visit www.viega.us.

©2019, Viega®, FostaPEX®, ManaBloc®, PureFlow®, ProPress®, and Smart Connect® are registered trademarks of Viega GmbH & Co. KG. Eco Brass® is a registered trademark of Mitsubishi Shindoh Co., LTD. Radel® R is a registered trademark of Solvay Advanced Polymers. Viega: Connected in quality® is a trademark of Viega Holding GmbH & Co. KG. RIDGID® is a registered trademark of RIDGID, Inc.

Introduction	6
Viega PureFlow Systems	6
Smart Connect® Technology	6
Codes, Standards, and Certifications	7
Specifying PureFlow Systems	7
Codes	7
Standards	7
Certifications	7
Fire Resistant Construction	8
PureFlow Press Fittings	10
PureFlow Press	10
PureFlow Press Zero Lead Bronze	10
PureFlow Press Polymer	10
PureFlow Press Fitting Markings	10
PureFlow Crimp Fittings	11
PureFlow Crimp	11
PureFlow Crimp Eco Brass Fittings	11
PureFlow Crimp PolyAlloy Fittings	11
PureFlow Crimp Fitting Markings	11
PureFlow Tools	12
PureFlow Press Hand Tools	12
PureFlow Press Power Tools	12
PureFlow Crimp Hand Tools	13
Product Instructions	14
Viega PureFlow Press Hand Tool	14
Viega PureFlow Press Power Tool	15
Viega PureFlow Crimp Hand Tool	16
Tubing Overview	17
PureFlow PEX Tubing	17
Properties and Performance	17
PureFlow PEX Tubing Markings	17
FostaPEX® Tubing	18
Properties and Performance	18
FostaPEX Tubing Markings	18
PureFlow PEX Tubing with Corrugated Sleeving	19
Properties and Performance	19
PureFlow PEX Tubing Markings	19
Design Considerations	20
General System Sizing and Calculations	20
Viega PureFlow Press Friction Loss	20
Viega PureFlow Crimp Friction Loss	20
Viega PureFlow PEX Tubing Flow Velocity	21
Viega PureFlow Pressure Loss	22

ManaBloc Systems	23
Viega Manifolds	23
Viega Manifold Markings	23
ManaBloc Design and Sizing	23
Supply and Distribution Line Sizing	24
Water Heater Placement	24
Distribution Line Sizing to Fixture	24
ManaBloc Installation Overview	25
Carton Contents	25
ManaBloc Location	25
Multiple ManaBloc Installations	26
Locating a Remote ManaBloc	26
ManaBloc Supply Piping Options	27
Draining the ManaBloc Unit	28
Draining the ManaBloc System	28
Mounting the ManaBloc	29
Mounting the ManaBloc Between Studs	29
Mounting the ManaBloc – Without Mounting Straps	31
Mounting the ManaBloc – Surface Mount	31
Mounting the MiniBloc	32
Mounting PureFlow Press and PureFlow Crimp Polymer Manifolds	33
Installing PureFlow Systems	34
Storage Recommendations	34
Do's	34
Don'ts	34
Handling Viega PureFlow PEX Tubing	35
Uncoiling PureFlow PEX Tubing	35
Bending PureFlow PEX Tubing	35
Removing PureFlow Connections	36
Repairs	36
Freezing	37
Water Heaters	37
Heaters, Flues, Vents, and Recessed Lights	38
Fastening the PureFlow System	39
Wood Frame Construction	39
Steel Construction	39
Supporting PureFlow PEX Tubing	40
Installation Considerations	41
PEX Risers	41
PEX Support Trays	42
Noise and Water Hammer	43
Shower Valves	44
Electrical Grounding	44
Expanding Foams	44
Fire Stop Compounds	45
Tubing Expansion	45

Calculating Expansion Loops and Offsets _____	46
Corner Expansion Offset _____	46
Z-Type Expansion Offset _____	46
U-Type Expansion Offset _____	47
FostaPEX _____	47
Coiled Loop _____	47
Domestic Hot Water Circulating Systems _____	49
Installing Viega PureFlow Fittings _____	50
Stub Out Options _____	50
PureFlow PEX Tubing Installed in Slab _____	51
Sleeving Requirements _____	51
Sealants _____	52
Heat Tape _____	52
Freeze Repair _____	52
Condensation Control _____	52
Installing PEX Under a Slab _____	52
Installing PEX Below Grade as Service Line _____	53
Trace Wire _____	53
Pressure Testing PureFlow Systems _____	54
General _____	54
Air Testing _____	55
Preparing for Air Pressure Test _____	55
Pressurizing the System _____	55
Completing the Air Test _____	56
Leak Detection _____	56
System Disinfection _____	57
General _____	57
California Flushing Requirements _____	57
Limited Warranty _____	58
Viega PureFlow Water System _____	58

Viega PureFlow Systems

Viega PureFlow is a high-quality, flexible PEX system for hot and cold potable water distribution. It is the most complete potable water solution available on the North American market. With tubing, fittings, and distribution manifolds, Viega provides everything you need for a total plumbing system that is not only easy to install but also helps reduce energy costs and water waste.

The Viega PureFlow plumbing system offers maximum security thanks to press and full-circle crimp fitting techniques. Viega provides the highest-quality PEX tubing with the best UV and chlorine ratings in the industry. All Viega PureFlow tubing, fittings, and manifolds are NSF certified for use in potable water systems.

Viega PureFlow and its related fittings are listed to the requirements of AWWA C904 and approved for use in water service applications. Viega offers a variety of threaded, solder, and ProPress® adapters to transition PEX to several types of piping materials.

The systems incorporate:



- Viega PureFlow PEX tubing: red, white, blue, and black cross-linked polyethylene tubing designed with superior chlorine and UV resistance.
- Black Viega PureFlow PEX tubing (¾" - 2"): UL 1821 listed for use in multipurpose one- and two-family fire sprinkler systems per NFPA 13D.
- Viega FostaPEX® tubing: cross-linked polyethylene with additional aluminum and polyethylene layers to provide rigidity and form stability, available in red or silver to differentiate hot water lines.
- A range of Zero Lead bronze, Eco Brass®, or polymer fittings for PureFlow Press and PureFlow Crimp fitting systems.
- Viega ManaBloc® distribution system for use with Viega PureFlow PEX tubing.
- A range of inline, manifold, and stop valves for Viega PureFlow fitting systems.
- Viega press tools and jaws for the PureFlow Press fitting systems.
- Viega crimp tools for the PureFlow Crimp fitting systems.

Smart Connect® Technology

Locating unpressed connections is an important step in the pressure testing process. Viega PureFlow Press Polymer fitting systems incorporate Smart Connect technology, providing quick and easy identification of unpressed connections during a pressure test.

Smart Connect technology is an integral part of the design of the fitting, providing a path for liquids and/or gases from inside the system past the sealing element of an unpressed connection. When pressed according to our Product Instructions, the fluid path is altered, creating a leak-proof, reliable connection.

Unpressed connections are located by pressurizing the system with air or water. When testing, the proper pressure range is 40 to 100 psi.

- 
- 1 Identify an unpressed connection during pressure testing when water flows out of the unpressed fitting joint.
- 
- 2 Upon identification, use the press tool to press the fitting, making a secure, leak-proof connection.
- 
- 3 Viega PureFlow connections are fast and reliable.

Specifying PureFlow Systems

Viega offers many tools to assist the specifying engineer, engineer, contractor, and installer to ensure Viega PureFlow systems are properly designed and installed. This can be done by referring to one of the resources listed below:

- Engineering Specifications are available at www.viega.us.
- Viega guide specifications in Master Spec format are available upon request at (800) 976-9819.
- Contact your local Viega field sales representative.

With a 25 year limited warranty and unmatched quality in the industry, Viega offers a complete system solution for all your plumbing needs.

Viega PureFlow PEX tubing and Viega PureFlow Press polymer fittings are manufactured in the United States and provide secure, reliable connections for residential and light commercial projects, ranging from potable water to snow melting applications.

Codes

The Viega PureFlow system is accepted by the following model codes for use in potable hot- and cold-water distribution systems:

- Housing for Urban Development (HUD)
- IAPMO: California Plumbing Code (CPC)
- IAPMO: National Standard Plumbing Code (NSPC)
- IAPMO: Uniform Mechanical Code (UMC)
- IAPMO: Uniform Plumbing Code (UPC)
- ICC – International Code Council
- ICC: International Mechanical Code (IMC)
- ICC: International Plumbing Code (IPC)
- ICC: International Residential Code (IRC)
- National Building Code of Canada (NBCC)
- National Plumbing Code of Canada (NPCC)

Check with your local Viega representative for code compliance in your area.

Standards

- ASTM E814
- ASTM E84
- ASTM F1807/F2159
- ASTM F876/F2023
- ASTM F877
- AWWA C904
- ISO 9001
- NFPA 13D
- NSF/ANSI 14
- NSF/ANSI 359
- NSF/ANSI 372
- NSF/ANSI 61

Certifications

- CAN/ULC S101
- CAN/ULC S102.2
- CAN/ULC S115
- CAN/ULC/ORD/ C199P
- Certificate of Listing
- cNSF®us pw-G
- CSA B137.5
- IAPMO R&T
- ICC – ES
- ICC ES-PMG™
- NSF U.P. Code
- NSF-pw certification mark
- PEX 5306
- TR 4 Listed Materials
- UL/ANSI 1821
- UL/ANSI 263

Note: Certifications available at:

- www.nsf.org
- www.spec-direct.com (Intertek)
- www.ul.com
- www.canada.ul.com

Fire Resistant Construction



U.S. listings
Plenum rating

Viega PureFlow PEX tubing has been tested and listed to the ASTM E84 with the following ratings:

Manufacturer	ASTM E84 Plenum Ratings / Listing			Limitations
	Products Listed	Flame Spread	Smoke Development	
Viega	3/8" to 2" PEX	25 or less	50 or less	1/2" minimum insulation thickness, no spacing limitations

Note: Listings include fitting connections in line when covered by insulation.

Viega PureFlow PEX has the following listings for each respective construction type:

ANSI/UL 263 and ASTM E119		
Construction Type	Assembly Type	Design No.
Wood Frame Construction	Floor / Ceiling	M517
	Walls	VL/FWDP 60-01
Noncombustible Concrete / Steel Construction	Floor / Ceiling	VL/FWDP 120-01
		VL/FWDP 120-02
	Walls	VL/FWDP 60-02

U.S. Fire Resistant Construction



Canadian listings
Plenum rating

Viega PureFlow PEX tubing has been tested and listed to the CAN/ULC S102.2 with the following ratings:

ASTM E84 Plenum Ratings / Listing				
Manufacturer	Products Listed	Flame Spread	Smoke Development	Limitations
Viega	¾" to 2" PEX	25 or less	50 or less	½" minimum insulation thickness, no spacing limitations
Viega	¾" to ½" PEX	25 or less	50 or less	No spacing limitations

Note: Listings include fitting connections in line when covered by insulation.

Viega PureFlow PEX has the following listings for each respective construction type:

ANSI/UL 263 and ASTM E119		
Construction Type	Assembly Type	Design No.
Wood Frame Construction	Floor / Ceiling	M522
	Walls	VL/FWDP 60-01
Noncombustible Concrete / Steel Construction	Floor / Ceiling	VL/FWDP 120-01
		VL/FWDP 120-02
	Walls	VL/FWDP 60-02

Canadian Fire Resistant Construction

PureFlow Press

Viega PureFlow Press fittings allow installers to make secure press connections in less than seven seconds. With Viega press technology, pressure testing can be completed immediately after connections are made.

Viega PureFlow Press fittings are approved for potable water and hydronic heating applications. They are available in sizes ranging from 3/8" through 2" in both Zero Lead and high-grade polymer materials and include a factory-assembled, stainless steel sleeve with three viewing holes and a tool locator ring to ensure a proper press connection.

The following design criteria make Viega PureFlow Press fittings ideal for use in potable water applications:

- High corrosion resistance
- Excellent strength properties
- Resistant to stress corrosion
- Superior wear properties
- Compatible with all materials

PureFlow Press Zero Lead Bronze

Viega PureFlow Press Zero Lead bronze fittings are manufactured from a high-quality Zero Lead material specifically designed for press technology meeting or exceeding all manufacturing requirements.

PureFlow Press Polymer

Viega PureFlow Press polymer fittings are manufactured from Radel R® and incorporate the Viega Smart Connect technology.

PureFlow Press Fitting Markings

Each Viega PureFlow Press fitting is marked where space permits with the following information:

Manufacturer	VIEGA
ASTM Standard	ASTM F877
Temperature Rating	180°F (potable), 200°F (hydronic heating)
Certifications	cNSF®us pw-G, CSA B137.5, UPC® or UP Code, cJLus®, ICC-ES PMG™ 1038 / 1015

Note: All fittings may not be listed with each organization shown.



WARNING!

Use only Viega stainless steel attached PureFlow Press sleeves and press tools with Viega PureFlow Press fittings.



Viega PureFlow Press polymer fittings must be protected from UV exposure, which can damage them. In the event of incidental UV exposure during storage, installation, and handling, combined exposure of PureFlow Press fittings shall not exceed 15 days.



Do not expose Viega products to any foreign substance that includes but is not limited to VOC (volatile organic chemical) compounds, paints, solvents, glues, cleaners, and disinfectants. Viega products that are exposed to these types of substances are at risk of having failures (leaks).



PureFlow Crimp

Viega PureFlow Crimp fittings are in metallic or polymer configurations. The following design criteria make PureFlow Crimp fittings ideal for use in potable water applications:

- Excellent strength properties
- Corrosion resistant
- Fast installation

PureFlow Crimp Eco Brass Fittings

PureFlow Crimp Eco Brass fittings are manufactured from a high-grade Zero Lead alloy.

PureFlow Crimp PolyAlloy Fittings

PureFlow Crimp PolyAlloy fittings are manufactured from a performance-grade polymer (Acudel® and/or Radel-R®) with excellent chlorine- and corrosion-resistant properties.

PureFlow Crimp Fitting Markings

Each PureFlow Crimp fitting is marked where space permits with the following information:

Manufacturer	VIEGA
ASTM Standard	ASTM F1807 (metallic), F2159 (polymer)
Temperature Rating	180°F
Certifications	UPC®, or U.P. Code, NSF-pw, CSA B137.5, cNSF®us pw-G, ICC-ES PMG™ 1038

Note: All fittings may not be listed with each organization shown.



WARNING!

Use only ASTM F1807 copper crimp rings and full-circle crimp tools with PureFlow Crimp fittings.



WARNING!

NOT for use with FostaPEX tubing.



Viega PureFlow Crimp PolyAlloy fittings must be protected from UV exposure, which can damage them. In the event of incidental UV exposure during storage, installation, and handling, combined exposure of PureFlow Crimp PolyAlloy fittings shall not exceed 15 days.



Do not expose Viega products to any foreign substance that includes but is not limited to VOC (volatile organic chemical) compounds, paints, solvents, glues, cleaners, and disinfectants. Viega products that are exposed to these types of substances are at risk of having failures (leaks).



Do not expose Viega products to any foreign substance that includes but is not limited to VOC (volatile organic chemical) compounds, paints, solvents, glues, cleaners, and disinfectants. Viega products that are exposed to these types of substances are at risk of having failures (leaks).

PureFlow Press Hand Tools

The Viega PureFlow Press connection must always be carried out with the aid of a Viega PureFlow Press tool. The hand tool incorporates a forced compression mechanism to complete a secure connection each time. A ratchet inside the tool prevents the tool from being opened until the proper force has been applied to the press sleeve. A safety release screw allows the tool to be opened at any time, but any connection made without full tool compression must be repressed. The tool handles are color coded to match the PureFlow Press tool locator rings.

The reduced grip feature permits one-handed operation, making the Viega PureFlow Press system ideal for tight spaces and awkward locations. The compression of the tool also allows press connections to be made in temperatures as low as -4°F .



PureFlow Press Power Tools

The Viega PureFlow Press connection may also be carried out with a Viega power tool. These RIDGID® tools are designed to make the same consistent press as the Viega PureFlow Press hand tools. The compression of the tool also allows press connections to be made in temperatures as low as 23°F .



RP-241-B Kit



Compact Power Tool RP-240

PureFlow Crimp Hand Tools

The Viega PureFlow Crimp connection must always be carried out with the aid of a Viega PureFlow Crimp tool. There are multiple configurations of Viega PureFlow Crimp tools that are ideal for tight spaces and awkward locations. The compression of the tool also allows for crimp connections to be made in temperatures as low as -30°F.



A caliper (GO/NO GO gauge) is available to check the calibration of the crimp tool. A crimp is good if the GO gauge fits over the ring and the NO GO gauge does not.

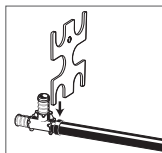

At least one connection should be checked at the beginning and end of each day to ensure proper crimps have been made. Most crimp tools can be recalibrated (refer to “Viega PureFlow Crimp Hand Tool” on page 16).

Viega PureFlow Press Hand Tool

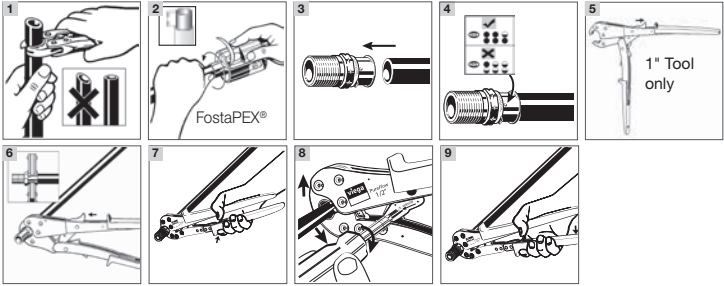

- 1** Square off tubing to proper length. Uneven, jagged, or irregular cuts will produce unsatisfactory connections.
- 2** If using FostaPEX tubing, insert into prep tool, push and turn until no resistance is felt.
- 3** Insert PureFlow Press fitting with attached sleeve into tubing and engage fully.
- 4** Ensure full tubing insertion at view holes in attached press sleeve. Full insertion means tubing must be completely visible in at least two view holes and partially visible in the one.
- 5** For the 1" tool, open the tool handles fully (thumb grip is available to maintain open jaw). Then close tool jaws to engage ratchet (ensure that thumb grip is returned fully forward before closing jaws).
- 6** Position the PureFlow press tool perpendicular over the press sleeve, resting it against the tool locator ring. For 1" tool, close tool jaws to engage ratchet (ensure that thumb grip is returned fully forward before closing jaws). Make sure the PureFlow press tool is properly aligned (see step 7 if it is not).
- 7** Close handles, using trigger to reduce grip span if desired.
- 8** If the PureFlow press tool is not properly aligned with the locator ring, use the emergency release (using a screw driver to turn the emergency release) to open the press tool. Once released, align the PureFlow press tool properly and go back to step 5.
- 9** Extend the PureFlow press tool handle and continue ratcheting until automatic tool release occurs at the proper compression force.



WARNING!

The connection is not leak-proof when the tool has been opened by emergency release. The tool locator ring must be present to ensure a proper PureFlow Press connection.



CAUTION!

Do not press twice.

i The tool locator ring must be in the factory-installed position while making a press to ensure a consistent leak-proof connection. It may be necessary to rotate the tool locator ring to avoid interference between the ring and tool.

Viega PureFlow Press Power Tool

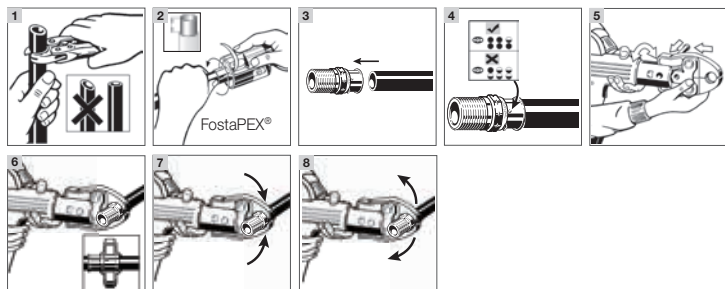

- 1** Square off tubing to proper length. Uneven, jagged, or irregular cuts will produce unsatisfactory connections.
- 2** If using FostaPEX tubing, insert into prep tool, push and turn until no resistance is felt.
- 3** Insert PureFlow Press fitting with attached sleeve into tubing and engage fully.
- 4** Ensure full tubing insertion at view holes in attached press sleeve. Full insertion means tubing must be completely visible in at least two view holes and partially visible in the one.
- 5** Insert the appropriate PureFlow Press Jaw into the press tool and push in the holding pin until it locks.
- 6** Open jaw and position perpendicular over press sleeve, resting it against the tool locator ring.
- 7** Start the pressing process; hold the trigger until the jaw has automatically released.
- 8** When press connection is complete, open and remove the jaw.

i The tool locator ring must be in the factory-installed position while making a press to ensure a consistent leak-proof connection. It may be necessary to rotate the tool locator ring to avoid interference between the ring and tool.

WARNING!
The tool locator ring must be present to ensure a proper PureFlow Press connection.

CAUTION!
Do not press twice.

Viega PureFlow Crimp Hand Tool

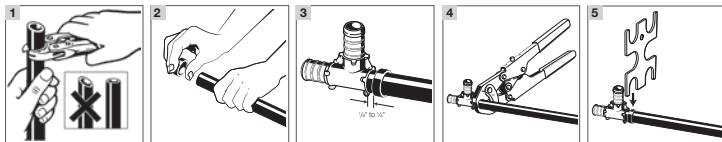

- 1 The tubing should be cut squarely and evenly without burrs. Uneven, jagged, or irregular cuts will produce unsatisfactory connections.
- 2 Slide the crimp ring onto the tubing and insert the fitting into the tube to the shoulder or tube stop.
- 3 Position the ring $\frac{1}{8}$ " to $\frac{1}{4}$ " from the end of the tubing.
- 4 The ring must be attached straight. Center the crimping tool jaws exactly over the ring. Keep the tool at 90° and close the handles completely.
- 5 When checking crimp connections with a caliper (GO/NO GO gauge), push the gauge STRAIGHT DOWN over the crimped ring. NEVER slide the gauge in from the side. Do not attempt to gauge the crimp at the jaw overlap area. The overlap area is indicated by a slight removal of the blackening treatment. A **crimp is acceptable** if the GO gauge fits the ring and the NO GO does not. A **crimp is unacceptable** if the GO gauge does not fit the ring or the NO GO gauge does fit. An incorrect crimp must be cut out of the tubing and replaced.



CAUTION!

Do not crimp twice.



Crimp dimensions can be verified with the provided Go/No-Go gauge.

PureFlow PEX Tubing

Viega PureFlow PEX (cross-linked polyethylene) is the ideal tubing choice for potable water systems. In addition, the smooth walls of Viega PureFlow PEX tubing are resistant to corrosion and scaling.



Properties and Performance

Linear Expansion Coefficient:

1.1 inch per 100 feet per 10°F

Temperature and Pressure Ratings:

180°F at 100 psi

73.4°F at 160 psi

UV Resistance:

Maximum exposure 6 months

Chlorine Resistance:

PEX 5306 – end-use condition of 100% at 140°F (approved for continuous domestic hot water circulation systems)

Bend Radius:

Viega PureFlow PEX can be easily bent by hand or with the use of Viega-approved bend supports (see “Wood Frame Construction” on page 39) to a radius as small as five times tubing outer diameter.

PureFlow PEX Tubing Markings

Viega PureFlow PEX tubing is marked every five feet with the following representative information.

Print Line Markings	
Length Marker	000 feet
Company	Viega
Product Name	Viega PureFlow PEX
Nominal Tubing Size	½"
Standard Dimension Ratio Tube Size	SDR 9 CTS (copper tube size)
Material Designation Code	PEX 5306
Temperature & Pressure Rating	100 psi @ 180F 160 psi @ 73F
NSF Listing (Potable)	cNSF®us-pw
NSF Chlorine Listing	CL5
ASTM Tubing Standards Certification	F876/F877
Canadian Standard Assoc	CSA B137.5
Fittings System Compatibility	PureFlow - ASTM F877/F1807/F2159
IAPMO Listing	UPC®
UL Listing Rating*	cULus 3SAV UL1821 130 psi @ 120F
Plenum Rating**	FS/SD 25/50 ASTM E84 CAN/ULC S102.2
Fire Resistance Ratings	CAN/ULC S101 ANSI/UL 263
ICC Listing	ES-PMG™ - 1038
AWWA Listing	C904
HUD Listing	MR 1276
Manufacturer's Date Code	1/1/2010
Material Code	X14.2
Country of Manufacture	Made in the USA

* ¾" through 2" Black Viega PureFlow PEX only

** 2" and smaller tube sizes when wrapped with ½" - 1" thick E84 rated insulation, ½" and smaller with no insulation per ULC S102.2 listing. Tubing may include fitting connections when wrapped.

FostaPEX® Tubing

Viega FostaPEX tubing is the ideal companion for the Viega PureFlow plumbing system. This tubing can be easily bent by hand like the Viega PureFlow PEX tubing but holds its shape after bending (combining the benefits of both rigid and flexible tubing). The result is fewer fittings and bend supports and less labor.

A unique feature of FostaPEX is that the inner layer is fully dimensioned Black Viega PureFlow PEX tubing. The aluminum and outer PE layers surround the inner PEX tubing. This construction allows the inner layer alone to meet all temperature and pressure requirements of the system. Using the prep tool to remove the outer layers allows the use of the standard Viega PureFlow Press Zero Lead bronze and polymer fitting systems, which reduces tooling costs for the contractor and simplifies connections.

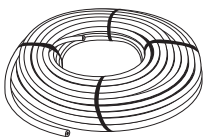

Properties and Performance

Linear Expansion Coefficient:

0.16 inch per 100 feet per 10°F

Temperature and Pressure Ratings:

200°F at 80 psi *

180°F at 100 psi

73.4°F at 160 psi

*For non-potable hydronic heating systems only

UV Resistance:

Maximum exposure 12 months.

FostaPEX should not be installed where permanently exposed to sunlight.

Chlorine Resistance:

PEX 5306 – end-use condition of 100% at 140°F (approved for continuous domestic hot water circulation systems)

Bend Radius:

FostaPEX tubing can be bent to a radius of 3.5 times tubing outer diameter with the use of a tubing bender.



WARNING!

Not for use with PEX Crimp fittings.

FostaPEX Tubing Markings

FostaPEX tubing is marked every five feet with the following representative information.

Print Line Markings	
Length Marker	000 feet
Company	Viega
Product Name	FostaPEX
Nominal Tubing Size	½"
Standard Dimension Ratio Tube Size	SDR 9 CTS (copper tube size)
Material Designation Code	PEX 5306
Temperature & Pressure Rating	100 psi @ 180F 160 psi @ 73F
NSF Listing (Potable)	cNSF®us-pw-rfh
NSF Chlorine Listing	CL5
ASTM Tubing Standards Certification	F876/F877
Canadian Standard Assoc	CSA B137.5
Fittings System Compatibility	PureFlow ASTM F877
IAPMO Listing	UPC®
Plenum Rating*	FS/SD 25/50 ASTM E84 CAN/ULC S102.2
Fire Resistance Ratings	CAN/ULC S101 ANSI/UL 263
ICC Listing	ES-PMG™ - 1015,1038
AWWA Listing	C904
HUD Listing	MR 1276
Manufacturer's Date Code	1/1/2010
Material Code	X18.1
Country of Manufacture	Made in the USA

* 2" and smaller tube sizes when wrapped with ½" - 1" thick E84 rated insulation, ½" and smaller with no insulation per ULC S102.2 listing. Tubing may include fitting connections when wrapped.

PureFlow PEX Tubing with Corrugated Sleeving

Viega PureFlow PEX tubing is available with a flexible polypropylene corrugated sleeving that is pre-installed on Viega PureFlow PEX red and blue 300-foot coils in 1/2" and 3/4" sizes. This sleeved PEX product is ideal for direct burial and/or cast in cement applications.

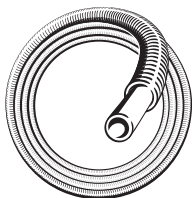

Properties and Performance

Linear Expansion Coefficient:

1.1 inch per 100 feet per 10°F

Temperature and Pressure Ratings:

180°F at 100 psi

73.4°F at 160 psi

UV Resistance:

Maximum exposure 6 months

Chlorine Resistance:

PEX 5306 – end-use condition of 100% at 140°F (approved for continuous domestic hot water circulation systems)

Bend Radius:

Viega PureFlow PEX can be easily bent by hand or with the use of Viega-approved bend supports to a radius as small as five times tubing outer diameter.

PureFlow PEX Tubing Markings

Viega PureFlow PEX tubing is marked every five feet with the following representative information.

Print Line Markings	
Length Marker	000 feet
Company	Viega
Product Name	Viega PureFlow PEX
Nominal Tubing Size	1/2"
Standard Dimension Ratio Tube Size	SDR 9 CTS (copper tube size)
Material Designation Code	PEX 5306
Temperature & Pressure Rating	100 psi @ 180F 160 psi @ 73F
NSF Listing (Potable)	cNSF®us-pw
NSF Chlorine Listing	CL5
ASTM Tubing Standards Certification	F876/F877
Canadian Standard Assoc	CSA B137.5
Fittings System Compatibility	PureFlow - ASTM F877/F1807/F2159
IAPMO Listing	UPC®
UL Listing Rating*	cULus 3SAV
	UL1821 130 psi @ 120F
Plenum Rating**	FS/SD 25/50
	ASTM E84 CAN/ULC S102.2
Fire Resistance Ratings	CAN/ULC S101 ANSI/UL 263
ICC Listing	ES-PMG™ - 1038
AWWA Listing	C904
HUD Listing	MR 1276
Manufacturer's Date Code	1/1/2010
Material Code	X14.2
Country of Manufacture	Made in the USA

* 3/4" through 2" Black Viega PureFlow PEX only

** 2" and smaller tube sizes when wrapped with 1/2" - 1" thick E84 rated insulation, 1/2" and smaller with no insulation per ULC S102.2 listing. Tubing may include fitting connections when wrapped.

General System Sizing and Calculations

Viega PureFlow systems should be designed following standard plumbing engineering practice. Follow local codes to determine minimum tubing size and required fixture pressures.

Pressure drop through fittings can be estimated from the charts on the following pages. Values are expressed in equivalent length of tubing, so add the values for the relevant fittings to the length of tubing in the run, and then determine the total pressure drop from the charts.

To determine the pressure drop through runs of Viega PureFlow PEX and FostaPEX tubing, refer to the “Viega PureFlow Press Friction Loss” tables below. For a known flow rate, tubing size, and tubing length, the pressure drop through the run can be easily determined.

Viega PureFlow Press Friction Loss

Equivalent feet of SDR9 PEX tubing

PureFlow Press Zero Lead Bronze Fittings				
Size	Coupling	Elbow	Tee Run	Tee Branch
3/8"	2.9	9.2	2.9	9.4
1/2"	2.0	9.4	2.2	10.4
3/4"	1.0	8.0	1.0	9.0
1"	1.0	10.0	2.0	10.0
1 1/4"	2.0	11.0	2.0	11.0
1 1/2"	2.0	13.0	2.0	12.0
2"	1.0	19.0	2.0	18.0

PureFlow Press Polymer Fittings				
Size	Coupling	Elbow	Tee Run	Tee Branch
3/8"	4.5	14.3	6.5	14.7
1/2"	2.6	12.6	3.9	14.0
3/4"	2.5	18.9	3.6	19.1
1"	3.1	17.7	3.8	18.4
1 1/4"	4.0	18.6	6.4	18.7
1 1/2"	5.2	29.4	7.9	28.3
2"	8.9	36.4	10.2	37.5

Viega PureFlow Crimp Friction Loss

Equivalent feet of SDR9 PEX tubing

PureFlow Crimp Eco Brass Fittings				
Size	Coupling	Elbow	Tee Run	Tee Branch
3/8"	2.9	9.2	2.9	9.4
1/2"	2.0	9.4	2.2	10.4
3/4"	0.6	9.4	1.9	8.9
1"	1.3	10.0	2.3	11.0

PureFlow Crimp PolyAlloy Fittings				
Size	Coupling	Elbow	Tee Run	Tee Branch
3/8"	10.9	22.3	N/A	N/A
1/2"	7.1	16.5	7.2	17.9
3/4"	4.8	17.4	6.6	17.7
1"	4.5	18.0	6.0	17.0

Viega PureFlow PEX Tubing Flow Velocity

Flow Rate GPM	Flow Velocity ft/sec						
	3/8	1/2	3/4	1	1 1/4	1 1/2	2
0.5	1.7	0.9			Velocity < 0.5 ft/sec		
0.75	2.5	1.4	0.7				
1.0	3.3	1.8	0.9	0.5			
1.5	5.0	2.7	1.4	0.8	0.6		
2.0	6.7	3.6	1.8	1.1	0.7	0.5	
2.5	8.3	4.5	2.3	1.4	0.9	0.7	
3.0	10.0	5.4	2.7	1.6	1.1	0.8	
3.5		6.3	3.2	1.9	1.3	0.9	0.5
4.0		7.2	3.6	2.2	1.5	1.1	0.6
4.5		8.1	4.1	2.5	1.7	1.2	0.7
5.0		9.1	4.5	2.7	1.8	1.3	0.8
6.0		10.9	5.4	3.3	2.2	1.6	0.9
7.0			6.4	3.8	2.6	1.8	1.1
8.0			7.3	4.4	2.9	2.1	1.2
9.0			8.2	4.9	3.3	2.4	1.4
10.0			9.1	5.5	3.7	2.6	1.5
11.0			10.0	6.0	4.0	2.9	1.7
12.0			10.9	6.6	4.4	3.2	1.8
13.0			11.8	7.1	4.8	3.4	2.0
14.0				7.7	5.1	3.7	2.2
15.0				8.2	5.5	4.0	2.3
16.0				8.8	5.9	4.2	2.5
17.0				9.3	6.3	4.5	2.6
18.0				9.9	6.6	4.8	2.8
19.0				10.4	7.0	5.0	2.9
20.0				11.0	7.4	5.3	3.1
25.0					9.2	6.6	3.8
30.0					11.0	7.9	4.6
35.0		Velocity > 12 ft/sec				9.2	5.4
40.0						10.6	6.2
45.0						11.9	6.9
50.0							7.7
55.0							8.5
60.0							9.2
65.0							10.0
70.0							10.8
75.0							11.5

Viega PureFlow Pressure Loss

Viega recommends the following velocities for hot and cold PEX water distribution systems:

■ Domestic cold water — 10 fps

■ Domestic hot water — 8 fps

The flow velocity through Viega's PEX fittings does not fall under these limitations. The equivalent length of PEX tube for Viega PureFlow fittings is available from Viega to assist in system sizing where applicable (refer to "Viega PureFlow Press Friction Loss" on page 20).

Flow Rate GPM	60°F (16°C) Water Pressure Loss PSI/ 100 ft of Pipe						
	3/8	1/2	3/4	1	1 1/4	1 1/2	2
0.5	2.0						
0.75	4.1						
1.0	7.0	1.6					
1.5	14.9	3.4					
2.0	25.4	5.8	1.1				
2.5	38.5	8.7	1.6				
3.0	53.9	12.2	2.3				
3.5		16.2	3.0				
4.0		20.8	3.9	1.1			
4.5		25.8	4.8	1.4			
5.0		31.4	5.9	1.7			
6.0		44.0	8.2	2.4			
7.0			10.9	3.2	1.2		
8.0			14.0	4.1	1.6		
9.0			17.4	5.1	1.9		
10.0			21.1	6.2	2.3	1.0	
11.0			25.2	7.4	2.8	1.2	
12.0			29.6	8.8	3.3	1.5	
13.0			34.3	10.1	3.8	1.7	
14.0				11.6	4.4	2.0	
15.0				13.2	5.0	2.2	
16.0				14.9	5.6	2.5	
17.0				16.7	6.3	2.8	
18.0				18.5	7.0	3.1	
19.0				20.5	7.7	3.4	
20.0				22.5	8.5	3.8	1.0
25.0					12.8	5.7	1.5
30.0					18.0	8.0	2.2
35.0						10.7	2.9
40.0						13.7	3.7
45.0						17.0	4.6
50.0							5.6
55.0							6.6
60.0							7.8
65.0							9.0
70.0							10.4
75.0							11.8

Note: Pressure loss based on Hazen-Williams formula (C = 150).

Pressure loss for actual length can be calculated by following formula:

Actual length / 100 ft x value from chart above.

Viega Manifolds

Viega offers several different manifolds to meet a variety of applications, whether it is a parallel water distribution system or combination installation.



Viega Manifold Markings

Each Viega manifold is marked, where space permits, with the following information:

Manufacturer	VIEGA
ASTM Standard	ASTM F877 / F1807 / F2159
Temperature Rating	180°F
Certifications	UPC®, cNSF ^{us} pw-G, CSA B137.5, ICC-ES PMG™ 1038

Note: All manifolds may not be listed with each organization shown.



WARNING!
To maintain your warranty and be code compliant, use only Viega-approved port adapters and supply adapters to connect Viega PureFlow PEX tubing to the ManaBloc.



Viega polymer manifolds must be protected from UV exposure, which can damage them. In the event of incidental UV exposure during storage, installation, and handling, combined exposure of Viega polymer manifolds shall not exceed 15 days.



Do not expose Viega products to any foreign substance that includes but is not limited to VOC (volatile organic chemical) compounds, paints, solvents, glues, cleaners, and disinfectants. Viega products that are exposed to these types of substances are at risk of having failures (leaks).

ManaBloc Design and Sizing

The general sizing information shown below may be appropriate for many ManaBloc installations. These recommendations are based on flow rates of typical fixtures that require 8 psi residual pressure.

The length of distribution tubing run between the Viega ManaBloc and each fixture shall be 50 feet or less to maximize optimal performance of the ManaBloc system. Exceeding this recommended distance affects the system's ability to efficiently deliver hot water, lengthening the time it takes for hot water to reach the fixture as well as increasing water waste. Check with local code for run length requirements.

If this cannot be accomplished with one ManaBloc, multiple ManaBlocs may be required. Place one at each end of the home to split the distribution line distance between them (see the section on "Multiple ManaBloc Installations" on page 26.)

Supply and Distribution Line Sizing

The best water and energy savings of a ManaBloc system are realized when distribution lines are sized according to the fixture demand and the length of the individual line. Viega recommends the following tube sizing.

Typical supply line size:

- ¾" up to 2½ baths
- 1" up to 4½ baths

Typical distribution line size:

- ¾" up to 2½ GPM fixture flow requirement (lavs, toilets, bidets, bar sinks, kitchen sinks, dishwashers)
- ½" up to 4 GPM fixture flow requirement (hose bibbs, tubs, showers, washing machines, whirlpool baths, soaking tubs, etc.)

Consult the fixture manufacturer's literature to determine the actual fill rate and residual pressure requirements for distribution line size. In addition, confirm with local Authority Having Jurisdiction (AHJ) for acceptable PEX tubing size.

Note: If a hose bibb is primarily for irrigation purposes, it should be supplied from the main service line prior to the ManaBloc.

A Viega PureFlow Press and PureFlow Crimp ManaBloc come with ½" ports that are designed to fit both ¾" and ½" PureFlow port adapters.

Water Heater Placement

The Viega ManaBloc should be as close as possible to the water heater to minimize extra water from being stored in the larger hot water supply lines between the ManaBloc and water heater.

The longer the hot water supply line is, the greater the volume of water needed to purge through that line and faucet before hot water is available. This creates water waste and longer hot water delivery times (see "ManaBloc Location" on page 25 for more information).

Distribution Line Sizing to Fixture

Proper water distribution line sizing to each fixture is crucial for overall system performance. If you oversize a distribution line to a fixture (½" PEX line supplying a sink instead of a ¾" PEX line) you are essentially doubling the volume of water being stored in that line. It can take roughly twice as long to purge an oversized line compared to a properly sized line.

The fixture is what dictates water flow (federally mandated, governed by code). The tubing applies a friction loss dictated by its size and length. Therefore, as long as you do not undersize a distribution line or run it excessive distances (60 feet or greater), the system will perform properly, maintaining sufficient pressure and flow.

ManaBloc Installation Overview

Carton Contents

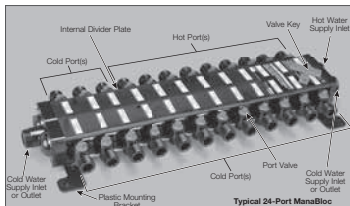

Additional package contents include:

- Valve T-Handle
- Instruction Sheet/Drill Guide
- Port Labels

ManaBloc Location

The ManaBloc is much like an electrical breaker box. When a fixture needs repair, the line to that fixture may be shut off at the ManaBloc, eliminating the need to shut down the water supply for the entire house. This feature requires that the ManaBloc be accessible after installation.

Before installing the ManaBloc, review the following instructions.

BEFORE INSTALLING THE MANABLOC, MAKE SURE THE FOLLOWING LOCATION REQUIREMENTS HAVE BEEN MET.



COLD WEATHER CAUTION!
The thermoplastic components of the ManaBloc, like all thermoplastics, have decreased resistance to impact under freezing conditions and can be damaged. Care must be exercised when installation occurs in freezing conditions.

Take extra caution when handling the ManaBloc in temperatures that are below freezing. Tubing penetrations may require sleeving or the installation of an insulator.

1. UNDER NO CIRCUMSTANCES shall the ManaBloc be located in a permanently covered area (behind sheetrock, plywood, paneling) or where freezing temperatures may occur. Do not install in direct sunlight. **THE MANABLOC MUST BE ACCESSIBLE** and there shall be sufficient clear area in front of the ManaBloc to provide access.
2. When local code allows, mount the ManaBloc unit in a fire-rated wall, provided an access door is installed over the access opening that meets the same rating requirements as the wall.
3. When installing the ManaBloc in a location other than between studs, provisions must be made to support the tubing runs as they exit the ManaBloc (see “Bending PureFlow PEX Tubing” on page 35).
4. Any installed cover panel shall allow access to the ManaBloc and its mounting screws, the port valves, distribution line connections, and supply line connections.
5. To maximize potential water and energy savings, the ManaBloc should be mounted as close as is practical to the hot water source, taking the following into consideration:
 - a. When the ManaBloc is mounted above the water heater, there shall be a minimum of 36" of connecting tubing between the water heater and the ManaBloc to reduce the chance of heat stacking.
 - b. When the ManaBloc is mounted beside the water heater and is connected with tubing incorporating a horizontal flow, there shall be at least 18" of developed tube length. Mounting the ManaBloc within eight feet of developed tube length of the water heater will minimize delivery time of hot water to individual fixtures. The ManaBloc may be mounted closer than 12" to the

hot water source (tank) if it does not exceed the minimum allowable vertical and horizontal spacing outlined in this section.

- c. Install the unit in an area that is centrally located to the most dense concentration of served fixtures. Some applications will require that the ManaBloc be mounted farther than eight feet from the hot water source. For design factors in installing a parallel system, refer to the PureFlow Water System Installation Manual for suggestions on reducing hot water delivery times in these instances.

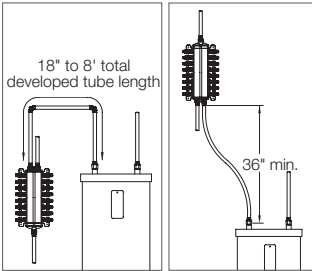

ManaBloc Locations

6. DO NOT install the ManaBloc within a continuously recirculating hot water plumbing loop. The ManaBloc, however, may be supplied from a recirculating hot water loop (refer to “Domestic Hot Water Circulating Systems” on page 49 for recommended options).
7. Position the ManaBloc so that it can be securely fastened through the holes provided in the mounting brackets. The mounting surface should be as flat as possible so as not to induce any twisting or bending forces on the unit. The mounting straps (part number 45716) simplify mounting between studs on 16" centers.

Multiple ManaBloc Installations

If a home requires multiple ManaBlocs to service the number of fixtures in the home, these guidelines should be followed if the ManaBlocs are closely located to each other.

- Consider dividing high-demand fixtures between the units.
- Consider a reasonable division, i.e., upstairs/downstairs, east/west, or front/back.

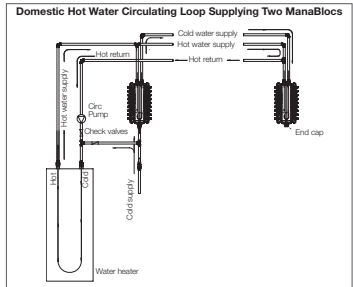

Locating a Remote ManaBloc

A remote ManaBloc is sometimes recommended to achieve maximum efficiency from your ManaBloc system. It is advantageous when the line lengths are excessive from one centralized ManaBloc unit. When the home requires more than one unit due to the number of fixtures or size of the home, consider locating a remote unit near an outlying group of fixtures.

ManaBloc Supply Piping Options

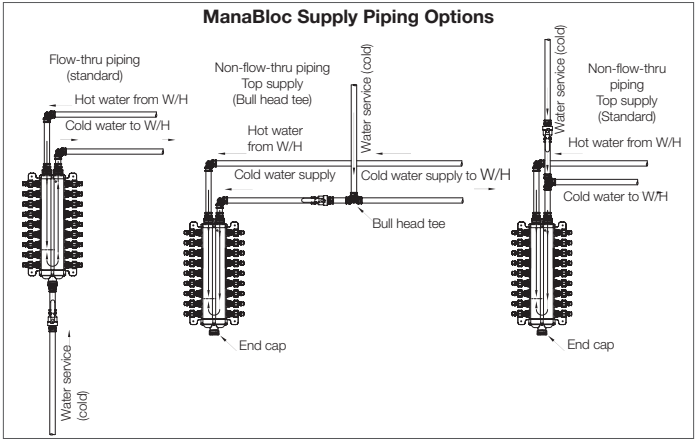

If a main inlet/outlet will not be used, it must be capped. (Use part number 53601.)

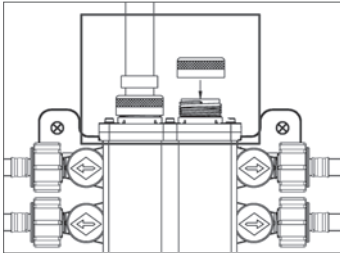

The main service line to the ManaBloc may include a main shutoff valve, as required by local code. Although a shutoff valve for the main service line at the ManaBloc itself is not required, it can be a beneficial option for a homeowner and is recommended.

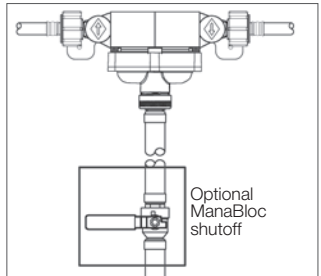

Local code may also require the installation of a check valve, Pressure Reducing Valve (PRV), back flow preventer, etc. To prevent debris and other particles from entering the system, a strainer may be installed in the service line.

Draining the ManaBloc Unit

If the ManaBloc system has been filled with water and there exists the possibility that the ambient temperature will drop close to or below 32°F (0°C), the ManaBloc unit MUST be drained to prevent irreparable damage. The process of draining involves loosening and removal of one or more supply line connections and two distribution lines from the ManaBloc.

Note: Depending on the installation, some supply connections may be capped. If that is the case, remove the cap(s) as instructed below.

1. Turn off all water supply(s) feeding the ManaBloc. Open both sides of all fixtures served by the manifold and leave the fixtures open during draining. For each port of the ManaBloc where there is a distribution line connected, make sure the port valve is in the open position.
2. Loosen and remove the bottom supply connection(s) (or cap(s)) and the lowest pair of hot and cold distribution lines.
3. As the connections are removed, most of the water contained in the ManaBloc main bores and some of the water in the distribution lines should purge from the system.
4. Allow to drain until no water purges.
5. Reattach the supply line(s) or cap(s) and the distribution lines. Tighten the supply connections according to the instructions in the PureFlow Water System Installation Manual. When reconnecting the distribution lines, DO NOT overtighten the connections. These only need to be hand-tight.

Note: This procedure will leave a small amount of water in the ManaBloc unit and, depending on the installation, may leave some or most of the water in the distribution lines. This remaining water should not cause damage to the manifold unit or to the PEX distribution lines in the event of a freeze. However, for complete assurance that freeze damage will not occur, perform the following additional steps.

Draining the ManaBloc System

1. Loosen and remove all of the supply line connections (or caps) and all of the distribution lines from the ManaBloc.
2. Remove the four attachment screws and withdraw the ManaBloc unit from its mounting. **Note:** Grasp the unit firmly before removing the last attachment screw to prevent the unit from falling and being damaged.
3. Completely drain the ManaBloc unit by inverting the unit several times until there is no water coming from any of the supply connections or ports.
4. To purge the PEX distribution lines, first make sure that both sides of all of the fixtures are in the open position. Using low-pressure air from a tank or compressor, force the water from the lines by connecting the air pressure source to each line one at a time and blow air through the lines until no water flows from the fixtures.
5. Reattach the ManaBloc and reconnect the supply and distribution line connections.

Note: When reconnecting the distribution lines, DO NOT overtighten the connections. Compression connections should require only about 1/8 turn past hand-tight when reinstalling connections that were previously tightened to the specifications outlined in the installation guide. PEX Press and PEX Crimp connections must be only hand-tightened.

Mounting the ManaBloc

Mounting the ManaBloc Between Studs

Dimensions in these instructions are for 16" stud centers and must be adjusted for other stud spacing.

Once the general location of the ManaBloc has been determined (see "ManaBloc Location" on page 25), the ManaBloc may be mounted to a suitable surface between a pair of adjacent studs. For 16" stud spacing, the mounting straps (part number 45716) can simplify installation.

Note: The wall in which the ManaBloc is mounted must be accessible from both sides during installation to use the mounting straps.

Additional tools and materials:

- Electric drill
- #2 Phillips head screwdriver
- Pencil or pen
- Permanent marking pen (optional)
- Framing square
- Tape measure
- 3/4" and 1 1/4" wood drill bits
- ManaBloc wrench - for compression ManaBlocs only (optional)
- Wood or drywall screws - 1/2" or longer
- 1/2" or 3/4" plywood - when flush mounting ManaBloc

1. Lay the ManaBloc, plastic brackets down, on a suitable flat surface that is large enough to accommodate the full length of the ManaBloc. Place a mounting strap under each plastic mounting bracket (located at the top and bottom ends of the ManaBloc). Attach the plastic mounting bracket at one end of the ManaBloc to the two outer center holes of a mounting strap using the provided self-tapping pan-head screws. The screw heads must be on the accessible side of the mounting strap. Repeat at the other end of the ManaBloc. Tighten screws securely.

2. Standing behind the stud wall, measure up from the floor and make a mark on the back of one of the studs to represent the top of the ManaBloc. This mark should be between four and six feet from the floor but may be at any height, provided the height will allow all valves on the ManaBloc to be accessible. With a framing square or level, transfer and mark the noted height on the other stud.

Note: A residence intended for disabled persons may require that the ManaBloc be mounted lower in the wall to provide access.

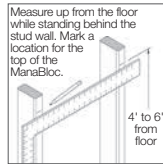

3. Standing behind the stud wall, hold the ManaBloc facing away from you and align the top of the UPPER mounting strap to the line on the stud that you made in Step 2. Loosely attach this mounting strap flush to the back outer edge of one stud using a 3/4" or longer drywall screw or other suitable wood screw (A).

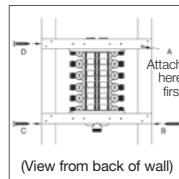

4. Line up the LOWER mounting strap with the back outer edge of the stud and attach it in the same manner (B). Attach the remaining strap ends (C and D) to the other stud, and tighten all screws.

- Standing in front of the wall, using a framing square or straight edge, mark the center line position of the top and bottom ports onto both studs.

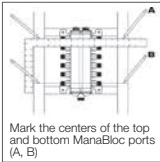

- Detach the ManaBloc from its mounting straps (or 1x4s) and remove it from the installation area to prevent wood chips or other debris from falling into the unit.
- Transfer the port location marks made in Step 5 to the insides of the stud cavity using a square and pencil.
- Measure $1\frac{5}{8}$ " from the mounting surface. Draw a vertical line on the studs that passes through each of the horizontal port center lines marked in Step 7. Be sure to mark the inside of both studs.

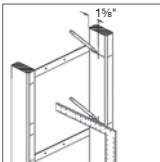

- Push a small nail through the printed center line at one end of the Drill Guide (A). Push the nail into the cross formed where the top port mark intersects with the $1\frac{5}{8}$ " mark. Tap the nail into the stud to hold the Drill Guide in place.
- Push a small nail through the printed center line on the lower end of the Drill Guide with the center line of the port (B). Tap the nail into the stud to hold the Drill Guide in place.

- Using an awl, nail, or other pointed tool (C), mark the stud by tapping through the Drill Guide at each printed center line between the two nails.

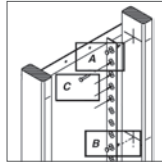

- Carefully remove the Drill Guide and repeat the marking procedure on the adjacent stud.
- Drill $\frac{3}{4}$ " holes through both studs at each marked location. Be sure to hold the drill level, perpendicular to the stud to prevent drilling holes at an angle. Remove any splinters or burrs made during drilling.
- Mark and drill any holes for main water supply and hot water supply/return lines at this time. A $1\frac{1}{4}$ " bit will provide adequate clearance for $\frac{3}{4}$ " or 1" tubing. The tubing shall enter and/or exit the ManaBloc in a straight line so as not to induce bending stress on the ManaBloc. Necessary elbows, couplings, and tees are allowed in the main water supply lines.

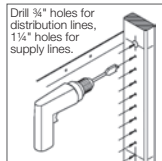

- Reattach the ManaBloc to the mounting straps.



When the ManaBloc is installed prior to wall finishing operations, the unit **MUST** be protected from paint, texture compounds, and drywall dust.

Mounting the ManaBloc – Without Mounting Straps

If not using the mounting straps, this procedure applies:

1. Cut two pieces of lumber (1x4 or ¾" plywood approximately 3½" wide) to a length that provides a snug fit BETWEEN two studs.
2. The top of the ManaBloc should be between four feet and six feet from the floor (but may be at any height provided that it maintains accessibility to all of the ports on the ManaBloc). Make a mark near the back of the inside of one stud that would represent the top of the ManaBloc. With a framing square or level, mirror the mark on the inside back of the other stud.
3. Attaching the ManaBloc between the studs:
 - a. Measure the total length of the ManaBloc.
 - b. Attach the first (UPPER) 1x4 inside and flush to the back of the studs at a height where the center of its width is centered on the marks from Step 2.

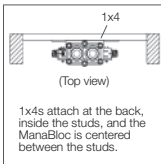

- c. Attach the remaining (LOWER) 1x4 inside and flush to the back of the studs at a distance below the upper 1x4 that is equal to the length of the ManaBloc (Step 3a) when measured from the top of the upper 1x4 to the bottom of the lower 1x4.

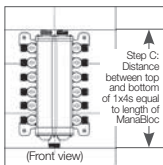

4. CENTER THE MANABLOC IN THE STUD CAVITY: Attach the ManaBloc to the 1x4s with four ½" - ¾" drywall screws. DO NOT OVER TIGHTEN.
5. Continue to Step 5 on the previous page to finish the installation.

Mounting the ManaBloc – Surface Mount

1. A suitable base for the ManaBloc can be constructed from a section of ½" or thicker plywood that is a minimum 22½" wide and slightly longer than the overall length of the ManaBloc.
2. Securely attach a length of 2x4, or other suitable framing material with a thickness of 1½" and about 3½" wide, on the left and right sides of the mounting base running the full length of the ManaBloc. The 2x4s will be used to secure the distribution lines at the correct height as they exit the ManaBloc. (Support clamps not to exceed 6" spacing from end of ports.)

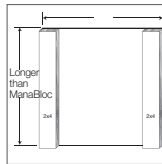

3. Attach the mounting base to the structure in a suitable location (see "ManaBloc Location" on page 25). The base should be mounted so the top of the ManaBloc is between four feet and six feet from the floor but may be at any height provided that the height maintains accessibility to all the ports on the ManaBloc.

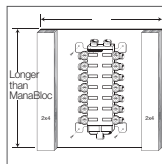

- The mounting base must be firmly attached to a structure solid enough to support, at a minimum, the weight of the ManaBloc filled with water. The base should be square and level.
- Center the ManaBloc on the base both vertically and horizontally. Attach the ManaBloc to the mounting base with four 1/2" or longer drywall screws or wood screws through the holes in the plastic brackets on the ManaBloc. **DO NOT OVER TIGHTEN.**

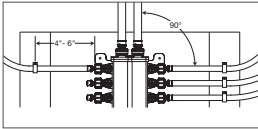

- As the distribution lines are connected to the ManaBloc (refer to the PureFlow Water System Installation Manual), ensure that the tubing exits the unit at a 90° angle to the center line of the ManaBloc so as not to induce bending stress on the ManaBloc.
- When attaching the distribution line tubing to the 2x4 supports, be sure to use appropriately sized Viega tubing clamps. (For example, use part number 52000 for 3/8" tubing and part number 52020 for 1/2" tubing.) Use one clamp per tube to ensure that the tubing is held securely. Position clamps **NO FARTHER** than 6" from the end of the port. **DO NOT** pull tubing tight.

Mounting the MiniBloc

- For proper bracket spacing, measure distance between the center ribs of the first and last MiniBloc modules. Mark this distance on the selected mounting surface.

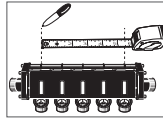

- Align the outside edge of each bracket within each end mark. Mounting brackets shall be mounted level and parallel to each other before affixing the MiniBloc manifold.

Note: Use both mounting brackets provided with each MiniBloc manifold. Ensure the mounting surface is suitable to support the weight of the manifold and attached tubing when filled with water.

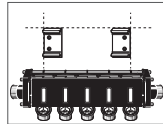

- Use two wood screws per bracket, 1" or longer, to prevent misalignment.

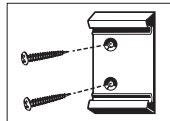

- Position bottom metal tie-rod into the bottom clip of the mounting brackets then roll manifold toward top clip. The MiniBloc may be mounted either vertically or horizontally.

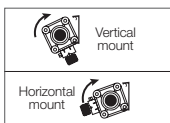

- Complete mounting by firmly pushing the MiniBloc toward the top clip of the mounting brackets, which should spread and snap over top of the metal tie-rod.

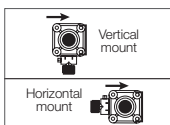

Mounting PureFlow Press and PureFlow Crimp Polymer Manifolds

Viega recommends using a minimum of two mounting brackets on manifolds with three ports and larger.

- Measure the distance (A) between the first and last set of manifold ports (as shown below). Using a straight edge, mark dimension (A) on the mounting surface. Ensure the mounting surface is level and suitable to support the weight of the manifold filled with water.

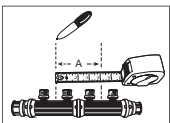

- Align the 1/4" lock clips (B) with the marks transferred from Step 1 and attach them using a 1" or longer screw appropriate for the mounting surface. **Note:** Lock clips sold separately (part number 58075).

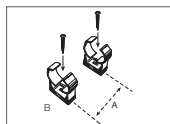

- With the lock clips in the open position, insert the manifold body into the clips, centering them between the end ports.

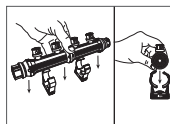

- Push evenly on both ends of the manifold until lock clips snap manifold body firmly into place. **Note:** Lock the clips into their second locking position to adequately secure the manifold.

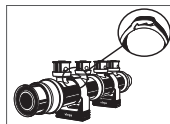

Storage Recommendations

Do's

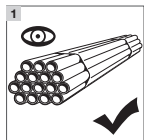

1 Inspect pipe and fittings before installing on the job site.

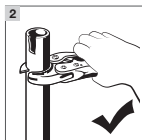

2 Damaged sections of tubing should be cut out and discarded.

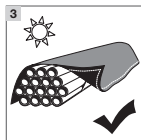

3 Cover any PEX exposed to direct sunlight with an opaque covering.



4 Handle PEX carefully, especially in freezing weather.

Don'ts

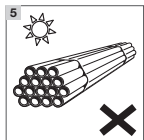

5 Do not expose Viega PureFlow tubing to sunlight or UV source for extended periods of time.

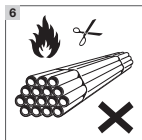

6 Do not expose Viega PureFlow tubing to sharp objects or open flames.

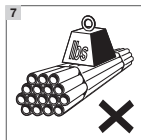

7 Do not store heavy objects on tubing or fittings.

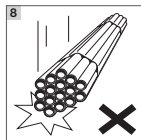

8 Do not handle PureFlow pipe and fittings roughly by gouging with tools, forcing, or dropping.

Handling Viega PureFlow PEX Tubing

The properties of Viega PureFlow PEX tubing make it easy to work with and install in most types of construction. Some care must be taken to prevent damage to the tubing before and during installation:

- Use care to protect both Viega PureFlow PEX and FostaPEX tubing from physical damage during storage and installation. Keep the tubing away from sharp objects, open flames, etc., and do not place heavy objects on the tubing.
- Damaged sections of tubing should be cut out and discarded.
- Do not expose Viega PureFlow PEX tubing to sunlight or any UV source for extended periods of time exceeding six months.
- FostaPEX, with its aluminum layer, is resistant to UV light, but long-term exposure should still be avoided.
- Do not store Viega PureFlow PEX or FostaPEX tubing outdoors where it may be exposed to UV light.



Uncoiling PureFlow PEX Tubing

An uncoiler should be used to prevent twisting when removing tubing from 3/8" to 1" coils. Roll coils out and use care to avoid twisting 1 1/4", 1 1/2", and 2" coils or when an uncoiler is unavailable.

Bending PureFlow PEX Tubing

Viega PureFlow PEX tubing can be free bent (unsupported bend) to a minimum radius of eight times the tubing O.D. and five times the tubing O.D. with the use of a Viega-approved bend support. Viega FostaPEX tubing can be free bent to a minimum radius of eight times the tubing O.D. and 3.5 times the tubing O.D. with the use of a Viega tubing bender. For situations requiring tighter bends, use elbow fittings. If bending against a PEX coil bend direction, the bending radius is 24 times the tubing O.D. Viega does not allow the practice of "hot bending" Viega PureFlow PEX tubing to make a tighter bend radius.

Viega PureFlow PEX Nominal Size*	Minimum Radius	
	Free Bend (8 x O.D.)	Supported (5 x O.D.)
3/8"	4"	2.5"
1/2"	5"	3.1"
3/4"	7"	4.4"
1"	9"	5.6"
1 1/4"	11"	6.75"
1 1/2"	13"	8.1"
2"	17"	10.6"

*Viega PureFlow PEX bend radius values were calculated using standard CTS O.D. dimensions, which are 1/8" larger than the nominal tube size listed.

Viega FostaPEX Nominal Size**	Minimum Radius	
	Free Bend (8 x O.D.)	Supported (3.5 x O.D.)
1/2"	5.6"	2.4"
3/4"	7.5"	3.3"
1"	9.6"	4.2"

** FostaPEX bend radius values were calculated using the actual O.D. dimensions, which include the additional aluminum and PE layers.

To reduce damaging stress on Viega PureFlow fittings, bend supports or tubing fasteners must be used to anchor all bends made close to fittings. Support must be provided for tubing bends located closer to fittings than distance “L” in the table below (also see the diagrams below for typical installation examples). Since FostaPEX will maintain its shape once bent, supports may not be necessary. However, support must be used at the “L” distance while making the bend.

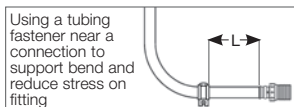
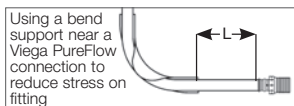
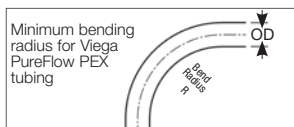

Removing PureFlow Connections

Should a mistake be made, simply cut out the PureFlow fitting and replace with a new one.



WARNING!

Do not reuse Viega PureFlow fittings

Repairs

Sections of kinked tubing should be repaired by cutting out the damaged section and installing a repair coupling.

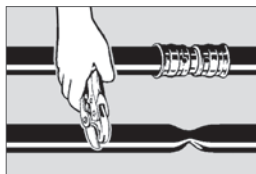

Inserting a coupling to repair kinked tubing

Tubing Size	Maximum distance from fitting to bend
3/8" PEX	L = 6 inches
1/2" PEX	L = 8 inches
3/4" PEX	L = 10 inches
1" PEX	L = 12 inches
1 1/4" PEX	L = 14 inches
1 1/2" PEX	L = 16 inches
2" PEX	L = 18 inches

Freezing

The flexibility of Viega PureFlow PEX tubing makes it resistant to damage from freezing, but precautions to prevent freezing should be taken when low temperatures might be encountered.

Insulating each PEX tube individually or as a group is not generally necessary if the PEX tubing is installed within the insulation envelope of the structure, i.e., the heated area. For example, the tubing may be installed under the insulation in the attic or within an interior wall of a heated space.

PureFlow PEX tubing systems should not be intentionally subjected to freezing.

Do not use open torch or excessive heat to thaw PureFlow PEX tubing. Tubing failure or damage can result.

Heat (DO NOT USE A TORCH) must be applied directly to the frozen tubing section. Temperature on tubing shall not exceed 180°F.

Several suitable methods exist to thaw PureFlow PEX tubing:

- Hot water
- Wet, hot towels
- Hand-held hair dryer
- Low-wattage electrical heating tape (self limiting)
- A commercial system that pumps heated water through a tube to the ice blockage and returns the cooled water for reheating



Water Heaters

Viega PureFlow PEX tubing should not be connected directly to gas-fired water heaters. The high temperatures of these appliances can damage the tubing.

When connecting a Viega PureFlow system to a gas-fired water heater, install a minimum of 18" of metallic piping between the water heater and tubing, keeping tubing more than 6" away from the vent pipe. Where local code allows, Viega PureFlow PEX tubing may be connected directly to electric water heaters and used for hot water recirculation lines that do not come within 6" of the gas heater vent.

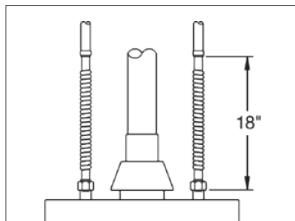

A minimum of 18" of metallic piping is required between a gas-fired water heater and PEX tubing.

Viega PureFlow PEX may be used to connect to instantaneous/tankless water heaters or other hot-water-producing devices. However, consult manufacturer's recommendations for use with plastic tubing and ensure temperature and pressure do not exceed the maximum ratings of the tubing.

Heaters, Flues, Vents, and Recessed Lights

Keep Viega PureFlow PEX tubing a **MINIMUM** of 12" vertically and 6" horizontally from sources of high heat such as gas flue vents, heating appliances, or electric motors.

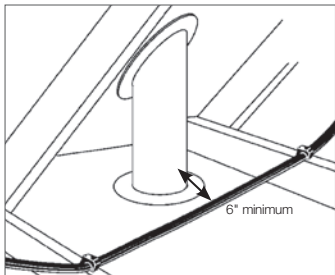
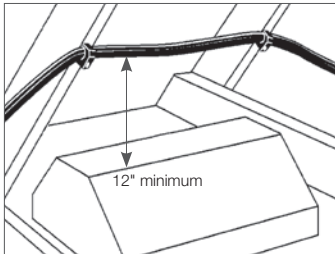

Maintain a minimum 12" of vertical and 6" of horizontal clearance from recessed lights and appliance or heater vents.

Concerning recessed lighting (including low-voltage types) and proper installation clearance, Viega recognizes the following types of lighting fixtures: Type IC or Inherently Protected, which allows direct contact with thermal insulation and other combustible materials, and Type Non-IC, which requires a minimum clearance of 3" from thermal insulation. If room does not allow for the minimum clearance spacing specified by Viega, then the PEX tubing must be insulated with a suitable pipe insulation capable of withstanding the specific maximum temperatures generated by the fixture. Minimum clearance between any pipe insulation and fixture shall be per the requirements of the fixture type and local building codes.

Forced air heating ducts and PVC power vent flues are not generally considered sources of high heat. These areas of installation should be rechecked after further construction and other mechanical systems have been installed.

In cases where light leakage (direct beam) from a UV-generating light source (special lighting or heating-type lamps) is possible, tubing must be adequately protected with light-blocking insulation.

Fastening the PureFlow System

Wood Frame Construction

Viega PureFlow PEX and FostaPEX tubing are ideal for use in wood frame construction. The ability to bend the tubing around corners and obstacles greatly simplifies installation. This system eliminates the expensive and time-consuming use of fittings where tubing turns within a wall, and it eliminates the potential fire hazard of soldering close to exposed framing members.

A few rules should be followed when running Viega PureFlow PEX tubing in wood frame construction:

- Use nailing plates to protect the tubing from nails and screws where it passes through studs.

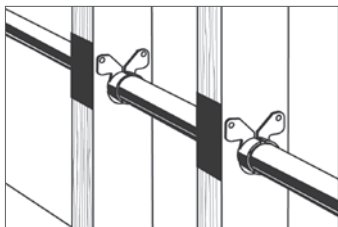

- Suspension clips are required for metal studs and optional for wooden studs.
- When turning tubing sharply to exit from a wall, a bend support must be used. Either use a drop-ear bend support, drop-ear elbow, or a stub out. Neglecting to use a support will place excessive stress on the fitting, and the tubing will not exit perpendicular to the wall (except FostaPEX).

Steel Construction

The Viega PureFlow system works as well in steel frame construction as it does in wood. Where tubing runs through metal studs, suspension clip fasteners must be used to protect tubing from sharp stud edges (see illustration below). Follow the same guidelines for fastening and supporting the tubing as for wood frame construction.



Suspension clip fasteners used to protect tubing from abrasion when passing through steel studs

Supporting PureFlow PEX Tubing

Use only plastic or plastic-coated tubing supports. Metal supports may damage tubing.

When running tubing, leave a small amount of slack between fasteners to account for tubing contraction.

Note that Viega PureFlow PEX tubing will expand or contract 1.1" per 100 feet for every 10°F of temperature change. In long straight runs, allow adequate clearance for this (see "Tubing Expansion" on page 45). The aluminum layer in FostaPEX reduces expansion and contraction, so that it expands only 0.16" per 100 feet for every 10°F of temperature change. This makes it ideal for locations where expansion must be minimized.

Tubing should be allowed freedom to move slightly as it expands. Do not clip it tightly into place or locate it where it will be tightly constrained. Use suspension clips or an approved plastic insulator where tubing passes through studs or joists where abrasion and noise are a concern.

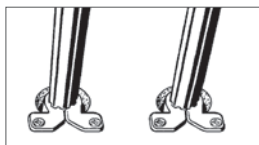

Suspension clips support tubing in joist penetrations or anywhere abrasion is a concern.

In risers or vertical runs, Viega PureFlow PEX and FostaPEX tubing should be attached with suspension clips or an approved plastic insulator at each floor or ceiling penetration, and every four feet in between.

WARNING! Some model codes may allow greater support spacing intervals for plastic tubing. Always refer to local code for approved spacing requirements that exceed the ones referenced in this guide.

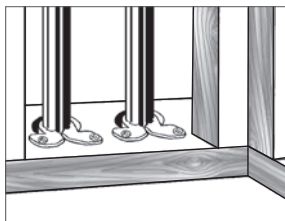

Suspension clip fasteners used at floor plate

Viega PureFlow PEX tubing must be fastened at a minimum interval noted in the table below for vertical and horizontal support.

	PEX Size	Horizontal	Vertical
Viega PureFlow PEX	½" - 1"	32" O.C.	Base of each floor with midlevel guide
	1¼" - 2"	48" O.C.	
FostaPEX	½" - 1"	32" O.C.	

PEX Support

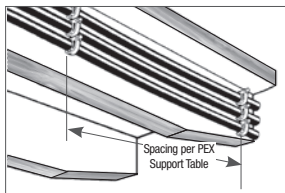

Tubing supported with U-clip or lock clip fasteners on horizontal runs

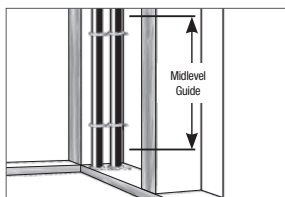

J-clamp or lock clip fasteners used to support tubing in vertical runs between floors

Installation Considerations

PEX Risers

Viega PureFlow tubing can be used as a riser to supply multiple floors with hot and cold water. To help control thermal expansion between multiple floors, use a midlevel guide at every floor and riser clamps at the following intervals:

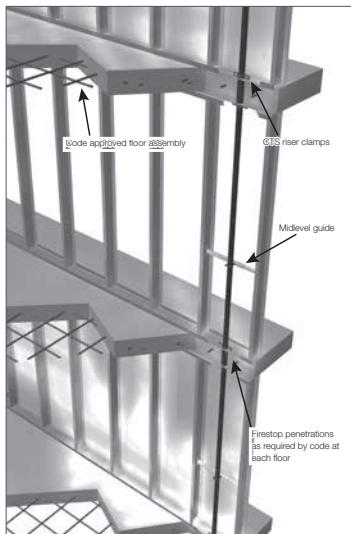

Hot Lines

Use clamps above and below the floor every other floor, with a single clamp above the floor in between.

Cold Lines

Use clamps above and below the floor every fourth floor, with a single clamp above each floor between.

Support

There are a variety of clamps and hangers to support PEX tubing risers to support members or wall surfaces. Always use products designed for use with plastic tubing that have no sharp edges or that can potentially flatten or crush PEX tubing.

Viega offers two types of multi clips that will fit up to 2" PEX tubing. One is designed to mount to a wall surface and comes with a mounting screw. The other type is designed to insert into a Uni-strut support bar. Lock clips, tubing insulators, and suspension clips are also available for use with PEX tubing. Ring clamps, clevis, or teardrop hangers shall have a rubber or protective lining when used with PEX tubing.



Installing PEX Under a Roadway

Viega PureFlow PEX tubing can be installed under a roadway as long as it is buried to the minimum frost level depth required by local code and following proper direct burial practices for plastic pipe.

PEX Support Trays

PEX support trays are for use with clevis hangers and/or coated ring clamps to help reduce the number of support hangers that are required for hanging PEX tubing. These trays are available in 10-ft. lengths for 1" through 2" PEX tubing sizes.

Installing PEX Support Trays

1. Install hangers at recommended spacing per table below.

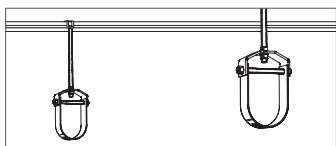

2. Install PEX tubing, slide the support trays under the tubing and into the hangers.

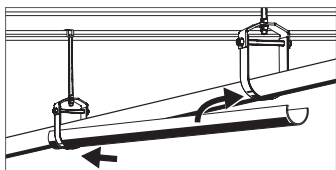

3. Snap the tubing into the support trays.

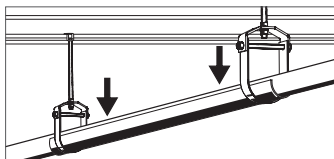

4. Trays shall be strapped to the tubing using Viega zip ties (or equivalent) every 48" (two straps for trays less than 48" in length) for clevis and/or teardrop hangers and only once between clamp-type hangers.

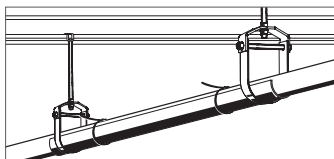

CAUTION!
When using tin snips or a reciprocating saw to trim support trays for shorter tubing runs, be sure to remove any sharp edges prior to installing trays onto the PEX tubing.

Note: Where space is available, it may be easier to install the support trays on the PEX tubing while on the floor and then install the tubing with trays attached onto the hangers.

Spacing Intervals

Tubing Size	Between Hangers*	Hanger to End of Tray	Between Trays	Fitting to Tray	Tray Overlap**
1"	8' max	min 1x nominal tube size	32"	2" min	4" min
1¼" - 2"	8' max	min 1x nominal tube size	48"	2" min	4" min

* Where trays are installed continuously it may be necessary to use closer hanger spacing to maintain a consistent hanger interval.

** A maximum of two continuous tray lengths shall be used where thermal compensation and/or offsets are required, typically every 50 ft.

Installation Details

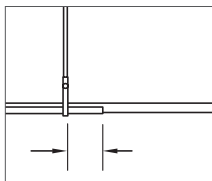

Hanger to end of tray

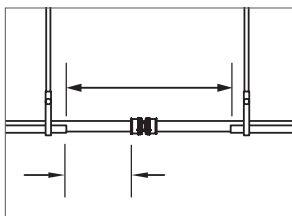

Fitting to tray / between trays

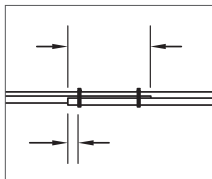

Overlap detail with straps

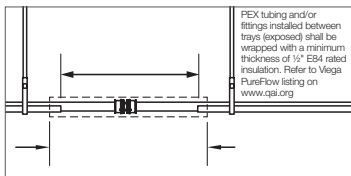

Plenum installation

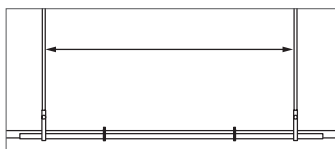
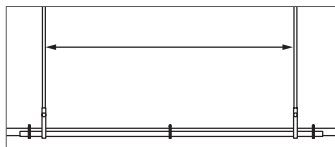

Tray strapping detail

Pipe Labels

When pipe labels are required, it is acceptable to place flexible, pressure-sensitive stickers directly on Viega PureFlow tubing and/or on jacketed insulation that is installed over the tubing. If label adhesion is an issue, zip ties can be used to assure long-term placement. Refer to local code for required pipe labeling and placement.

Noise and Water Hammer

As with all plumbing materials under some operating conditions, a water hammer can occur in PEX plumbing systems. The inherent flexibility of Viega PureFlow PEX drastically reduces the magnitude of pressure surges compared with metallic plumbing materials. Damage to plumbing components in a PEX system due to these pressure surges is highly unlikely, although noise can sometimes result. Fortunately, there are solutions to minimize or eliminate water hammer noise.

- Install fixtures that are not water hammer prone. As a general rule, two-handle fixtures are less likely to cause a hammer than single-handle fixtures. Single-handle shower valves, which rotate to close and therefore are difficult to close quickly, might be good choices.
- Clamping or strapping more frequently may help prevent tubing noise. It is important that the tubing not be in contact with the wallboard, forced air ducts, or other high-resonance articles. Insufficiently or improperly clamped or strapped tubing may move during fixture operation and hit against these surfaces.
- Install a water hammer arrester at fixtures where noise is a problem. A water hammer arrester (AA sized) installed as closely as possible to the fixture on the cold-water side only will eliminate the source of the noise (the pressure wave). It should be noted that even with an arrester, tubing that is clamped or strapped insufficiently may still hit against something as it moves slightly when the water flow is stopped.
- Avoid operating fixtures in such a way that causes near instantaneous shutoff. Simply closing fixtures in a less abrupt manner can eliminate hammer noise.

Shower Valves

PEX lines should only be run to the inlet connections of tub/shower valves unless specifically approved by the valve manufacturer for other connections.

Electrical Grounding

Neither Viega PureFlow PEX nor FostaPEX tubing may be used as an electrical ground. Consult the NEC for recommended grounding method when plastic pipe is used.

Expanding Foams

When penetrations must be sealed for air infiltration purposes, there are several options available. Use a good grade of silicone, acrylic, or siliconized acrylic caulking. DO NOT use oil-based caulks. Other materials may be used provided they do not cause short- or long-term damage to the PEX tubing.



WARNING!

When using expanding spray foam to insulate walls in a structure, there are several options available. Viega suggests using water-based or urethane-based open-cell insulation only. Do not use closed-cell spray foams. Both open-cell and closed-cell spray foams have the potential to generate high temperatures during their expansion process, especially when not applied properly, which can damage PEX tubing. Therefore, Viega suggests applying open-cell spray foam in layers up to 1.5 inches thick and allowing the insulation to cool before applying additional layers. Additionally, Viega's PureFlow polymer fittings and manifolds should be wrapped with a protective coating prior to the application of spray foam to avoid damage. Protective coatings can be either a polyethylene film or aluminum wrap. Viega's metallic fittings do not require additional protection from open-cell spray foam. Always follow the spray foam manufacturer's installation instructions and warnings.



Do not expose Viega products to any foreign substance that includes but is not limited to Volatile Organic Chemical (VOC) compounds, paints, solvents, glues, cleaners, and disinfectants. Viega products that are exposed to these types of substances are at risk of having failures (leaks).

Fire Stop Compounds

Most building codes require the use of a fire-stopping compound when tubing penetrates a fire-rated wall. There are a number of fire-stopping compounds identified as water based, acrylic, or latex that have been listed for use with PEX tubing that include but are not limited to the following:

- 3M Fire Protection – CP 25WB+ Caulk
- Tremco, Inc – TREMstop® IA
- Specified Technologies, Inc. – SpecSeal® SSS 100 / SSS 102
- Passive Fire Protection Partners – Fire Stop™ 4800 DW / 4100 DW / 4100 NS / 3600 EX

It is the responsibility of the user to determine the suitability of these or any products for the intended application and install the compounds in accordance with the product's installation instructions and listing.

Tubing Expansion

Viiega PureFlow PEX tubing, as with any PEX tubing, expands and contracts with temperature changes in the environment or the fluid inside the tubing. The longer the tubing run and the higher the temperature change, the more linear expansion the system will experience. This expansion and contraction can affect the appearance as well as integrity of the system by putting stress on the tubing, fittings, valves, and fasteners.

Tubing fasteners perform two functions: providing support for the tubing and guiding the tubing during expansion and contraction. It is important to keep this in mind when installing fasteners. An expansion compensator will not be effective if the fasteners prevent linear movement of the piping system.

Tubing sizes smaller than 3/4" generally do not require expansion compensators with fittings and can easily be bent into loops and offsets to absorb linear expansion. For tubing sizes 1" and larger, refer to "Calculating Expansion Loops and Offsets" on page 46 for compensation options.

For unconstrained tubing runs (not within the floor) Viiega recommends the use of expansion offsets. This can be accomplished at a corner or by using offsets or loops on straight tubing runs. Expansion compensators should be installed at the midway point of tubing runs and should be spaced no more than 50 feet apart.

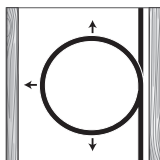

Using a loop to accommodate tubing expansion

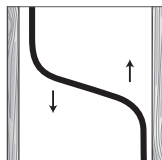

Offsets also provide room for tubing expansion.

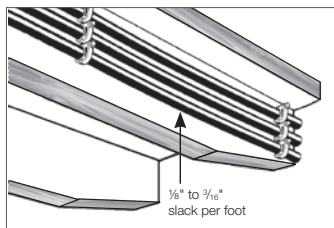

Allow some slack in all runs to prevent damage from tubing contraction.

Below is an example of required offsets for a 100-foot tubing run. Note that the expansion compensators are no more than 50 feet apart.

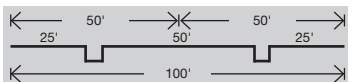

Calculating Expansion Loops and Offsets

There are three types of expansion offsets recommended for use with large-diameter tubing: the corner expansion offset, the Z-type expansion offset, and the U-type expansion loop. Descriptions and illustrations for each type of offset are located on the next several pages (see “FostaPEX” on the facing page for FostaPEX recommendations).

Corner Expansion Offset

Where piping takes a corner after a long straight run, a simple 90° elbow in the piping will allow for the absorption of expansion.

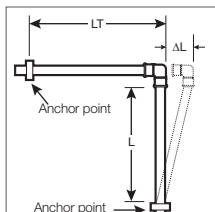

Corner Offset

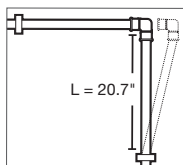

Corner Expansion Example

Z-Type Expansion Offset

The Z-type expansion offset integrates two 90° elbows that form a “Z” pattern.

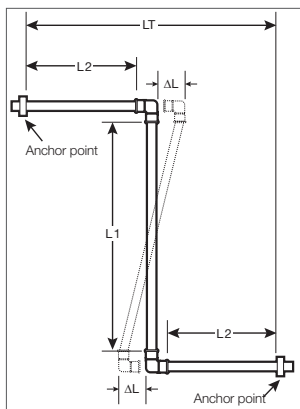

Z-Type Offset

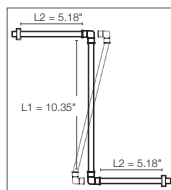

Z-Type Expansion Example

U-Type Expansion Offset

The U-type expansion loop integrates four 90° elbows that form a “U” pattern.

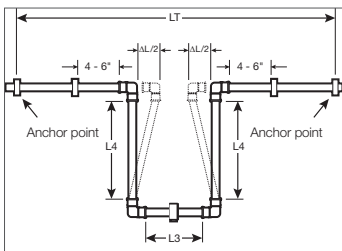

U-Type Looped Offset

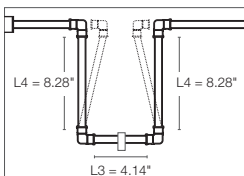

U-Type Expansion

See the PureFlow Water System Installation Manual or the PureFlow Commercial Water System Design Manual for details on how to do calculations.

FostaPEX

FostaPEX tubing has a fully dimensional PEX wall with an additional outer layer of aluminum and polyethylene. As a result of these extra layers, FostaPEX expands considerably less than that of standard PEX tubing and slightly more than copper tubing (0.16" per 100 feet per 10°F).

An approved method for expansion absorption when using FostaPEX is through the use of a coiled loop expansion compensator (at least every 50 feet). Do not use fitting offsets with FostaPEX as the stiffness of FostaPEX may lead to high stress at connections.

Coiled Loop

The coiled loop configuration calls for loops within the piping system. The diameter of the loop (D) is shown in the table and will increase or decrease as the tubing in the system expands and contracts.

Note: Tubing fasteners should be secured as to not prevent linear movement of tubing.

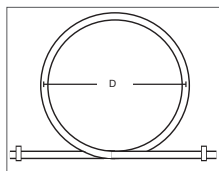

Coiled Loop Expansion

Coiled Loop Expansion

Tube Nominal Size	D (Diameter)
1/2" FostaPEX	12"
5/8" FostaPEX	14"
3/4" FostaPEX	16"
1" FostaPEX	20"

Installing PureFlow Systems

Tubing Tube nom.		Z-Type Expansion Offset (inches) per 50 linear feet of run															
		60		80		100		120		140		160		180		200	
$\Delta T(^{\circ}F)$		L1	L2	L1	L2	L1	L2	L1	L2	L1	L2	L1	L2	L1	L2	L1	L2
Veiega PureFlow PEX	¾"	10.2	5.1	11.8	5.9	13.2	6.6	14.4	7.2	15.6	7.8	16.7	8.3	17.7	8.8	18.6	9.3
	1"	11.6	5.8	13.4	6.7	15.0	7.5	16.4	8.2	17.7	8.8	18.9	9.5	20.1	10.0	21.1	10.6
	1¼"	12.8	6.4	14.8	7.4	16.5	8.3	18.1	9.1	19.6	9.8	20.9	10.5	22.2	11.1	23.4	11.7
	1½"	13.9	7.0	16.1	8.0	18.0	9.0	19.7	9.8	21.3	10.6	22.7	11.4	24.1	12.1	25.4	12.7
2"	15.9	8.0	18.4	9.2	20.5	10.3	22.5	11.3	24.3	12.2	26.0	13.0	27.6	13.8	29.1	14.5	

Tubing Tube nom.		U-Type Expansion Offset (inches) per 50 linear feet of run															
		60		80		100		120		140		160		180		200	
$\Delta T(^{\circ}F)$		L3	L4	L3	L4	L3	L4	L3	L4	L3	L4	L3	L4	L3	L4	L3	L4
Veiega PureFlow PEX	¾"	4.1	8.2	4.7	9.4	5.3	10.5	5.8	11.6	6.2	12.5	6.7	13.3	7.0	14.2	7.5	14.9
	1"	4.6	9.3	5.3	10.7	6.0	12.0	6.6	13.1	7.1	14.2	7.6	15.1	8.0	16.0	8.5	16.9
	1¼"	5.1	10.2	5.9	11.8	6.6	13.2	7.2	14.5	7.8	15.6	8.4	16.7	8.9	17.7	9.4	18.7
	1½"	5.6	11.1	6.4	12.9	7.2	14.4	7.9	15.7	8.5	17.0	9.1	18.2	9.6	19.3	10.2	20.3
2"	6.4	12.7	7.4	14.7	8.2	16.4	9.0	18.0	9.7	19.5	10.4	20.8	11.0	22.1	11.6	23.2	

The fastener shown on the L3 leg may be required to provide additional support depending on how the expansion loop is installed (horizontal/vertical).

Domestic Hot Water Circulating Systems

A hot water circulation system can be incorporated into most plumbing systems and works by constantly (or periodically throughout the day on a timer) circulating hot water through the main hot supply line of the plumbing system.

This is done by using a return line at the end of the main hot supply line and a low-flow pump (usually near the hot water tank). The circulating system keeps hot water readily available throughout the main hot water supply line, eliminating the need to purge the entire line before hot water is present at the fixture.

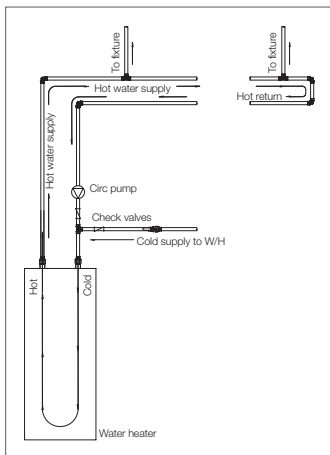

Typical domestic hot water circulation piping

There are a number of hot water circulation systems available in the marketplace that offer a variety of options. These systems are ideal for branch-and-main or combination systems with spread-out fixture groups/ floor plans, as well as for larger homes using multiple ManaBlocs in a parallel-type system.

Viiega PureFlow PEX can be used in recirculating domestic hot water plumbing loops, provided:

1. The plumbing loops shall operate with water temperatures of 140°F or lower, as required by most model plumbing codes.
2. The recirculating loop is for supplying hot water more quickly to the fixture.
3. The tubing is marked as rated for “continuous recirculation” as evidenced by the ASTM F876 certification marking PEX 5306 (CL5).

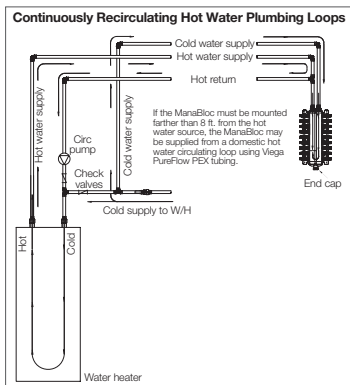

Installing Viega PureFlow Fittings

Stub Out Options

The Viega PureFlow system includes fittings to accommodate most plumbing needs. Stub outs are available for a variety of fixture situations, as well as fittings and valves to connect to other plumbing materials and fixtures.



Standard stub outs with 90° bends and a closed end to facilitate pressure testing are available in either 3/8" or 1/2" PEX x 1/2" copper.

Also, PureFlow Press copper tub elbow and PureFlow Crimp shower valve adapters are available for easy connections to tub and shower valves.



Drop-ear elbows provide a 1/2" or 3/4" F NPT threaded connection at a wall or floor penetration as well as a flange for securing the fitting.

Drop-ear bend supports allow Viega PureFlow PEX tubing to be directly stubbed out of a wall. These supports allow the tubing to make the tight bend necessary to exit the wall at a 90° angle as well as providing a flange for securing the support.

The exposed tubing can then be connected to a valve, using an optional chrome sleeve to cover the tubing if desired.

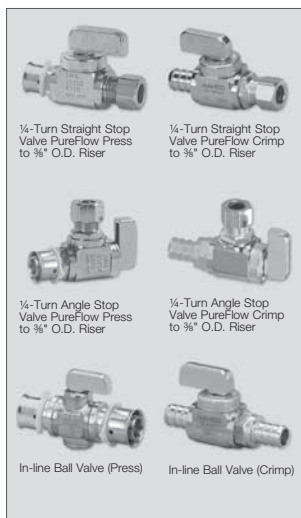

Commercial Ball Valve

PureFlow PEX Tubing Installed in Slab

Viega PureFlow PEX tubing can be installed within concrete slabs. Every effort should be made to use only continuous lengths of tubing within the slab.

When running tubing within a concrete slab, the tubing must be fastened to the reinforcing mesh or rebar every two to three feet to prevent it from floating up while concrete is curing.

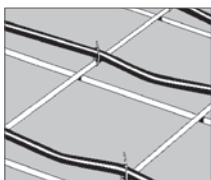

Tubing must be fastened to the reinforcing mesh on rebar with the use of plastic zip ties

Viega offers corrugated sleeved PEX for additional underground or in-slab protection. This allows for easy removal and replacement if future issues arise.

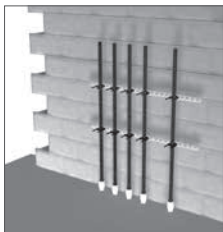

Sleeving Requirements

All penetration points of Viega PureFlow PEX tubing run within concrete slabs or walls (entry/exit points, expansion joints, etc.) must be sleeved to protect the tubing from expansion and contraction. Sleeving may consist of a larger piece of plastic tubing or open- or closed-cell insulation with a wall thickness no less than 0.022" thick.

Where sleeves are used, they shall be securely fastened to the assembly penetrated. Insulation and covering on or in the penetrating item shall not penetrate the assembly unless specific material used has been tested as part of the assembly.

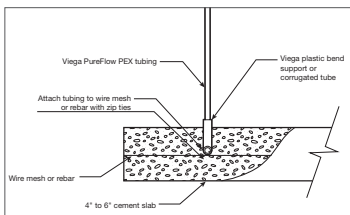

PEX in slab

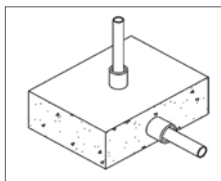

Elbow sleeves protect tubing at concrete slab penetrations

Sealants

The space between corrugated sleeving and opening of a building envelope, wall, floor, or ceiling assembly penetrated by a pipe shall be sealed in an approved manner with caulking material, foam sealant, or gasketing system tested in accordance with ASTM E814 or UL 1479.

Use of a silicone, acrylic, or silicized acrylic caulk may be necessary to seal any voids between PEX tubing and the sleeving material. Most canned expanding foams and open- or closed-cell pipe insulation are also good sealing materials and may be used in direct contact with PEX tubing. DO NOT use oil-based caulks or closed-cell spray foams!

If the use of fittings buried in concrete is necessary for repairs, all such fittings must be wrapped with insulation, noncorrosive tape (no adhesives) or sleeved to prevent corrosion. The wrap shall be a self-fusing, formaldehyde-free, fully cured silicone tape with a minimum of 0.020" thickness. The wrap is available from Viega (part number 15320). Contact a Viega representative for additional information on approved wrapping materials.

Heat Tape

It is an acceptable practice to use heat tape on PEX tubing as long as it is a self-limiting type not controlled by an external thermostat. Below is a list of manufacturers that offer heat tapes meeting these requirements:

- EasyHeat® /10800 series
- Heaterzone.com
- WRAP-ON / PIPE-GUARD™
- BriskHeat®

Freeze Repair

The flexibility of Viega PureFlow PEX tubing makes it resistant to damage from freezing. PEX tubing systems should not be intentionally subjected to freezing.

However, if freezing occurs, there are several methods to thaw PEX tubing.

- Hot water
- Wet, hot towels
- Hand-held hair dryer
- Low-wattage electric heating tape (self limiting)
- A commercial system that pumps heated water through a tube to the ice blockage and returns the cooled water for reheating



WARNING!

Heat must be applied directly to the frozen tubing section. Temperatures on tubing shall not exceed 180°F.



WARNING!

Do not use open torch or excessive heat to thaw PEX tubing. Tubing failure or damage can result.

Condensation Control

As a general practice, anywhere metal piping requires insulation for condensation control, plastic piping will too. Always check code for necessary insulation requirements.

Installing PEX Under a Slab

When installing Viega PureFlow PEX or FostaPEX tubing in the ground under the slab, the tubing should be snaked from side to side in the prepared trench. The trench bottom should be smooth and free of rocks and debris. Lay the tubing directly on the trench bottom. Tubing must be continuously supported by the trench bottom. Use only continuous lengths of tubing in or under the slab. Any connections must be outside the slab or in an access box.

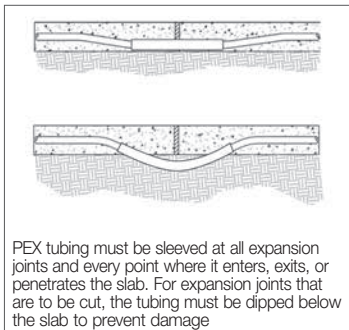

PEX tubing must be sleeved at all expansion joints and every point where it enters, exits, or penetrates the slab. For expansion joints that are to be cut, the tubing must be dipped below the slab to prevent damage

Installing PEX under the slab

Installing PEX Below Grade as Service Line

Viega PureFlow PEX and FostaPEX tubing may both be used underground and for water service piping. When running lines underground, it is important to provide a stable, continuous trench base to support the tubing.

Always allow sufficient slack when tubing is laid in trenches. Snake the tubing slightly side to side to provide for contraction due to temperature change.

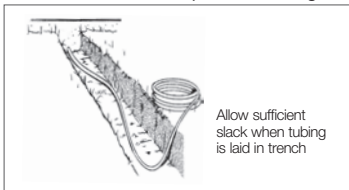

Allow sufficient slack when tubing is laid in trench

Do not use blocking to support tubing. PEX tubing can be damaged by contact with sharp objects. Ensure that the trench bottom and fill do not contain sharp rocks or other items. In good soil conditions, tubing may be placed directly on trench bottom. In poor soil conditions (rocky, loose, etc.) the trench should be excavated at least six inches

below the tubing level and backfilled with appropriate material to provide a stable base (coarse sand, pea gravel, or similar).

Backfill material must be free of large rocks, glass, or other sharp objects. Provide sufficient coverage over tubing so that expected traffic loads will not deform tubing (consult local codes). Compact this material to at least 6" above the tube.

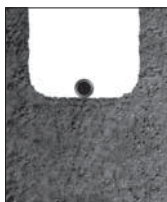

Trench in poor soil



Trench in good soil

Installing PEX below grade

Do not install Viega PureFlow PEX tubing where soil is or may become contaminated with solvents, fuels, or similar chemicals. Do not install tubing above or below septic tanks, leach fields, pits, or cesspools.

Always follow local codes when installing Viega PureFlow PEX tubing. Consult standards such as ASTM D2774: Standard Recommended Practice for Underground Installation of Thermoplastic Pressure Piping for further information.

Trace Wire

It is an acceptable practice to use trace wire to assist with the detection of Viega underground piping systems. Refer to local code for minimum wire gauge and material requirements.

General

Upon completion of a Viega PureFlow plumbing system installation, a hydrostatic (potable water) pressure test shall be conducted. If potable water is not available, or the potential for freezing conditions exists, pneumatic* (air or nitrogen) testing and/or the use of an RV antifreeze** solution are also acceptable methods for pressure testing.

- *Use air testing only if approved by local code or the Authority Having Jurisdiction (AHJ).
- **RV antifreeze shall be drained and flushed from all portions of the plumbing system prior to consumer use.

Always refer to local plumbing code for pressure testing requirements and approved methods specific to plastic plumbing systems. If none is specified, refer to the following table for acceptable methods, test pressures, and durations.

**Testing Viega PureFlow Systems
(Branch and Main / ManaBloc)**

Test Method	Min/Max Duration	Max Pressure (psi)	Min Pressure (psi)	Allowable Variance (psi)
Water	15 min/ 1 hr	100	40	NA
Air	15 min/ 1 hr	100	40	8*



WARNING!

WATER TESTING SHALL BE AVOIDED DURING FREEZING CONDITIONS. UNDER NO CIRCUMSTANCES SHALL THE SYSTEM BE TESTED AT TEMPERATURES LOWER THAN 10°F (-12°C).



ManaBloc Valve Information!

Opening a port valve to an empty or unpressurized distribution line may cause valve damage.

To prevent potential valve damage or failure, open the port valves before filling and pressurizing the lines. The force of water rushing to fill an empty line can cause the valve's seal to "clip off," resulting in incomplete sealing or complete valve failure.

CARE must be exercised when opening a port valve to an empty or unpressurized line. The fixture to which the line is connected should be in the OFF position and the valve must be opened slowly until water starts to flow into the line.

DO NOT CONTINUE to open the valve until the line is full and pressurized. Open the valve fully only after the line is up to system pressure. The fixture can then be opened to purge the line of air.

Valve stems are replaceable. Order part number 51602.



WARNING!

FOLLOW ANTIFREEZE MANUFACTURER'S INSTRUCTIONS FOR CONCENTRATIONS. Use only nontoxic antifreeze approved for drinking water systems.

Note: If such a solution is used, the antifreeze solution must be sufficiently concentrated to withstand the lowest temperature encountered while the testing fluid is in the system. Antifreeze solutions should be purged and the system flushed with potable water prior to consumer use.



WARNING!
PRESSURES USED IN
TESTING CAN BLOW
UNMADE OR INCOMPLETE
CONNECTIONS APART WITH
TREMENDOUS FORCE!

This force is many times greater when air is used as a test medium. To reduce the risk of personal injury, ensure that all connections are completed before testing. Use only the pressure and time required to determine that the system is leak free.

* If the pressure in the system declines more than 8 psi during the 15-minute to one-hour period, repressurize the system to the original test pressure and retest. If the system pressure declines more than 8 psi again during the test period, test the distribution line test caps or any other fittings in the system with the approved leak-detect solution.

Note: Some plumbing fixtures may not withstand test pressures greater than 80 psi. Consult fixture manufacturer's instructions for pressure limitations or plug all distribution lines at the fixture end. The system shall, at a minimum, withstand the test pressure, without leaking, for a period of 15 minutes.

Air Testing

Air testing of a Viega PureFlow plumbing system shall use the following procedure provided to ensure safety.



WARNING!
It is the responsibility of the installer to read and understand the below pressure testing criteria and all safety precautions. Compressed air can store extremely high energy as compared to compressed water systems. Failure to follow these steps could result in personal injury, death, and/or property damage.

Preparing for Air Pressure Test

- Notify other trades that air pressure test will be conducted on the plumbing system. Only qualified personnel should be present during system testing.
- Use only compressed air or nitrogen that is free of any kind of lubricating oils.
- Do not conduct pressure testing overnight or if a large temperature change is anticipated.
- Before pressurizing the system, conduct a visual inspection to ensure proper connections have been made throughout the plumbing system.
- All personnel involved in the pressure testing shall wear, at a minimum, eye and hearing protection. It is recommended the person applying the pressure to the system wear a full face shield.
- Only Viega PureFlow plumbing system components (tubing/fittings/manifolds) shall be pressure tested. All other system components (water heaters and fixtures) shall be isolated from the pressure test.
- Contact the inspector and schedule the pressure test.

Pressurizing the System

- Verify no other trades are present prior to starting the pressure test. Only qualified testing personnel should be present during pressure test.
- Introduce pressure into the system as outlined in the stages below.

Stage 1: Gradually increase system pressure to 10 psi (over the course of approximately 30 seconds).

- Wait for 10 minutes before inspecting pressure gauge.
- If pressure holds steady, continue to Stage 2.
- If pressure falls over the test period, look for potential leaks with an approved leak-detect solution. Once system pressure is completely relieved and the leak is fixed, restart test procedure.

Stage 2: Gradually increase system pressure to 50 psi (over the course of approximately 1 minute).

- Wait for 10 minutes before inspecting pressure gauge.
- If pressure holds stable, continue to Stage 3.
- If pressure falls over the test period, look for potential leaks with an approved leak-detect solution. Once system pressure is completely relieved and the leak is fixed, restart testing procedure from beginning.

Stage 3: Gradually increase system pressure to 100 psi (over the course of approximately 1 minute).

- Inspect gauge pressure over next 10-minute period to verify pressure has not decreased more than the allowable variance noted in the table on the preceding page.
- If pressure variance allowed is not exceeded, the system test has passed.
- If pressure decreases more than the allowable variance, the test has failed. Apply approved leak-detect solution (see “Leak detection” below) on fitting and/or manifold connections to isolate the location of the leak. Once system pressure is completely relieved and the leak is fixed, start testing procedure from beginning.

Completing the Air Test

Depressurize system.

- Use of the same safety equipment applies to these steps.
- Slowly bleed off any remaining air pressure from system (approximately 1-minute duration).
- Notify other trades the test is complete and the work area is safe to occupy.
- Document the time and date the test was completed and the pressure and duration of the test.

Leak Detection

Viega has identified the leak-detection solutions listed below as being compatible for use with Viega PureFlow Press system components. Consult leak-detect manufacturer for proper application and product instructions. To determine the compatibility of other leak-detection solutions not listed below, contact Viega Technical Services prior to their use.

- megabubble® Leak Detector
- Oatey® All Purpose Leak Detector
- Snoop Liquid Leak Detector

As an alternative leak detection, a mixture of Original Palmolive Green™ dishwashing soap (#46100-46200) or Palmolive Ultra™ (#356140 or 46128) mixed with potable water at a ratio of two ounces of soap to one gallon of water (mix Ultra at a ratio of 1.5 ounces per gallon) may be used.

Note: If the solution does not show a leak on any of the caps or fittings, isolate the ManaBloc by turning the valves to the “OFF” position, repressurize if needed and apply the same solution to the ManaBloc manifold components.

General

Local codes may require system disinfection. When no other method is available, follow the time limitations and exposure levels shown below.

1. Use a chlorine solution and one of the exposure durations listed below:

Concentration	Period	Authority
200 PPM	3 hours	IPC/UPC®
50 PPM	24 hours	IPC/UPC®

2. Mix the disinfection solution thoroughly before adding it to the system.
3. The chlorine solution must reach all parts of the system. Open all fixtures (both sides) and flow water until a chlorine smell is present. As an alternative, chlorine test tablets can be used to detect chlorine at each fixture.
4. The chlorine source for the solution can be, but is not limited to, the following:

Chlorine Source	% Active Chlorine	Form	Amount Per 100 Gallons Water for a 200 PPM Solution
Laundry bleach	5.25	Liquid	3 pints (48 oz.)

5. After the solution has been in the system for the time required by the Authority Having Jurisdiction (AHJ) or the exposure durations listed in Step 1, the system shall be flushed completely with potable water.
6. The system must be purged or drained of all water or protected from freezing.



FAILURE TO FLUSH THE SYSTEM NOTICE!!

To prevent reduced service life of system components, disinfection solutions shall not be allowed to stand in the system longer than 24 hours. Thoroughly flush the system with potable water after disinfection.

California Flushing Requirements

The State of California requires all installations of PEX piping, where it is the initial plumbing system installed in new construction, shall be flushed twice over a period of at least one week. The piping system shall be first flushed for at least 10 minutes and then filled and allowed to stand for no less than one week, after which all the branches of the piping system must be flushed long enough to fully empty the contained volume. This shall not apply to installations of PEX tubing where it replaces an existing tubing system of any material.

At the time of fill, each fixture shall have a removable tag, shown below.

This new plumbing system was first filled and flushed on _____ (date)
by _____ (name)

The State of California requires that the system be flushed after standing at least one week after the fill date specified above. If this system is used earlier than one week after the fill date, the water must be allowed to run for at least two minutes prior to use for human consumption.

This tag may not be removed prior to the completion of the required second flushing, except by the building owner or occupant.



The following warranty does not cover fire protection and motor home / RV applications. For warranty information on these and other applications, refer to applicable warranty.

Viega PureFlow Water System

Subject to the conditions and limitations in this Limited Warranty, VIEGA LLC (Viega) warrants to the owner of applicable real property in the United States (including its territories) and Canada that the components in its PureFlow Plumbing System (as described below) when properly installed by licensed plumbers in potable water systems, under normal conditions of use, shall be free from failure caused by manufacturing defects for a period of twenty-five (25) years from date of installation.

The Viega PureFlow Plumbing System and components covered by this twenty-five (25) year warranty are:

Viega PureFlow cross-linked polyethylene (PEX) tubing or PureFlow FostaPEX® tubing installed with PureFlow Press fittings in metal or polymer and PureFlow Press sleeves sold by Viega installed as a system.

Viega PureFlow cross-linked polyethylene (PEX) tubing and ASTM F1807 metal crimp insert fittings sold by Viega and ASTM F2159 PolyAlloy crimp fittings sold by Viega installed with copper crimp rings as a system.

Viega warrants that ManaBloc®, MiniBloc or polymer or metallic manifolds, and their approved connections, sold by Viega and installed as a manifold plumbing system under normal conditions of use, shall be free from failure caused by manufacturing defects for a period of ten (10) years from date of installation.

Power tools and jaws used with PureFlow Press fittings are warranted by the manufacturer and Viega extends no separate warranty on those tools or jaws. Viega warrants that PureFlow Press hand tools sold by Viega, under normal conditions of

use, shall be free from failure caused by manufacturing defects for a period of two (2) years from date of sale. Viega warrants that PureFlow Crimp hand tools and tubing cutters sold by Viega, under normal conditions of use, shall be free from failure caused by manufacturing defects for a period of twelve (12) months from date of sale.

Viega warrants that properly installed PureFlow valves, PureFlow lav and closet risers and riser accessories manufactured and/or sold by Viega shall be free from failure caused by manufacturing defects for a period of two (2) years from date of installation.

Viega does not extend any warranty on its components used in systems with tubing, fittings, manifolds, or press sleeves not sold by Viega or installed by other than a licensed plumber. In addition, the warranty does not apply if distribution lines and their connections to manifold plumbing systems sold by Viega are not Viega Pureflow PEX or PureFlow FostaPEX tubing or approved connections sold by Viega.

Connection to non-Viega plumbing products intended for riser and/or water service applications does not void the system warranty provided all pipe, fittings, valves and manifolds are sold by Viega after the transition location.

Termination connections to non-Viega end-use devices or equipment such as filtration, water softeners, shower valves, faucets, stops and other such devices, when utilizing Viega PureFlow PEX and PureFlow FostaPEX does not void the system warranty as described.

Under this limited warranty, you only have a right to reimbursement if the failure or leak or resulting damage resulted from

a manufacturing defect in the products covered by this warranty and the failure or leak or resulting damage occurred during the warranty period. You do not have a remedy or right of reimbursement under this warranty and the warranty does not apply if the failure or leak or resulting damage is caused by (1) components in the plumbing system other than those manufactured or sold by Viega; (2) not designing, installing, inspecting, testing, or operating the system in accordance with Viega's installation instructions at the time of the installation, applicable code requirements and good plumbing practices; (3) improper handling and protection of the product prior to and during installation, exposure to ultra violet light, inadequate freeze protection, exposure to water pressures or temperatures in excess of the limitations on the tubing or application of unauthorized or harmful solvents or chemicals; (4) chemically corrosive or aggressive water conditions; or (5) acts of nature such as earthquakes, fire, flood or lightning.

In the event of a failure or leak in the system, it is the responsibility of the property owner to obtain and pay for repairs. Only if the warranty applies will Viega be responsible for reimbursement under this warranty. The part or parts which you claim failed should be kept and Viega contacted at the address below or by telephoning 800-976-9819 within thirty (30) days after the failure or leak and identifying yourself as having a warranty claim. You should be prepared to ship, at your expense, the product which you claim failed due to a manufacturing defect, document the date of installation, and the amount of any claimed bills for which you seek reimbursement. Within a reasonable time after receiving the product, Viega will investigate the reasons for the failure, which includes the right to inspect the product at Viega and reasonable access to the site of damage in order to determine whether the warranty applies. Viega will notify you of the results of this review.

In the event that Viega determines that the failure or leak and any resulting damages were the result of a manufacturing defect

in the products covered by the 10-year or 25-year limited warranties and occurred during the first ten (10) years covered by this warranty, Viega will reimburse the property owner for reasonable repair or replacement charges to include drywall, flooring and painting costs, as well as damages to personal property, resulting from the failure or leak. The remaining 15-year limited warranty for products covered by the 25-year limited warranty will cover material costs for pipe and fittings only, sold by Viega, not inclusive of any labor or installation costs. Any change in property ownership after the first ten years will nullify any remaining warranty coverage.

VIEGA SHALL NOT BE LIABLE FOR CONSEQUENTIAL ECONOMIC LOSS DAMAGES UNDER ANY LEGAL THEORY AND WHETHER ASSERTED BY DIRECT ACTION, FOR CONTRIBUTION OR INDEMNITY OR OTHERWISE.

THE ABOVE LIMITED WARRANTY IS IN LIEU OF ALL OTHER WARRANTIES, EXPRESS OR IMPLIED, INCLUDING BUT NOT LIMITED TO, THE IMPLIED WARRANTIES OF MERCHANTABILITY AND FITNESS FOR A PARTICULAR PURPOSE. IF FOUND APPLICABLE, ANY IMPLIED WARRANTIES ARE LIMITED TO THE DURATION OF THE TIME LIMITS SET OUT IN THIS WRITTEN WARRANTY. Other than this limited warranty, Viega does not authorize any person or firm to create for it any other obligation or liability in connection with its products. This written warranty applies for the first 10 years of the applicable warranty regardless of any change of ownership in the property.

Some states do not allow the exclusion or limitation of incidental or consequential damages or limitations on the duration of implied warranties in certain types of transactions, so the above exclusion or limitations may not apply to you. This limited warranty gives you specific legal rights and you also may have other rights which vary from state to state. This warranty shall be interpreted and applied under the law of the state in which the product is installed.



Viega LLC

585 Interlocken Blvd
Broomfield, CO 80021

Ph: 800-976-9819
Fax: 800-976-9817
www.viega.us

