

38 Offset Steel Eye Socket Rod Hanger – 0380037EG

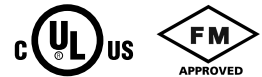

- Structural attachment used to join hanger rod to a structure
- Provides full vertical rod adjustment

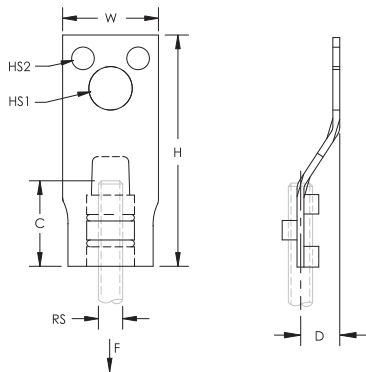

Part Number	0380037EG
Material	Steel
Finish	Electrogalvanized
Rod Size (RS)	3/8"
Pipe Size	4" Max
Hole Size 1 (HS1)	1/2"
Hole Size 2 (HS2)	1/4"
Height (H)	3 1/4"
Width (W)	1 1/8"
C	1 3/16"
D	3/4"
Static Load (F)	250 lb
Certifications	cULus FM
Standard Packaging Quantity	250 pc
UPC	78285635090

Load rating dependent on wood structure strength.

For 3/8" rod through 2" pipe, use two Model #43 Wood Drive Screws. For 3/8" rod through 4" pipe, use one Model #42 1/2" x 3" Lag Screw.

FM is a registered certification mark of FM Approvals LLC, LTD. UL, UR, cUL, cUR, cULus and cURus are registered certification marks of UL LLC.

WARNING

nVent products shall be installed and used only as indicated in nVent's product instruction sheets and training materials. Instruction sheets are available at www.erico.com and from your nVent customer service representative. Improper installation, misuse, misapplication or other failure to completely follow nVent's instructions and warnings may cause product malfunction, property damage, serious bodily injury and death and/or void your warranty.

© 2021 nVent All rights reserved

nVent, nVent CADDY, nVent ERICO, nVent ERIFLEX and nVent LENTON are owned by nVent or its global affiliates.

All other trademarks are the property of their respective owners. nVent reserves the right to change specifications without prior notice.

