

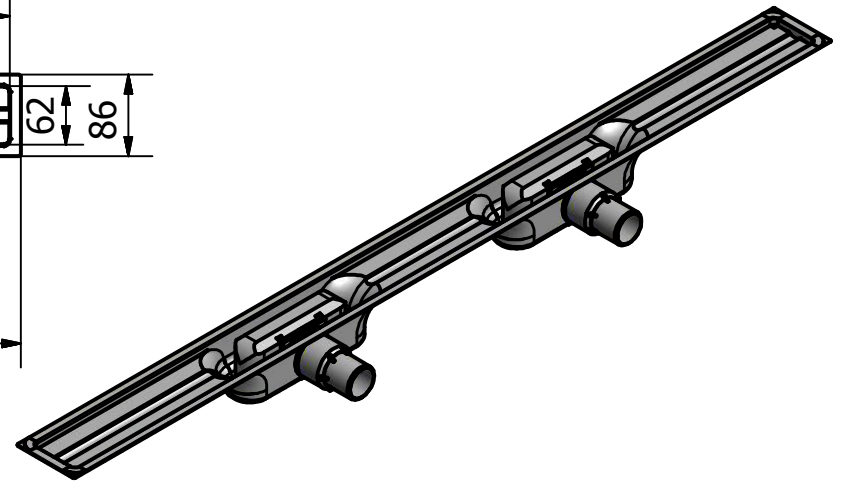

A'-A' ( 1/2 )

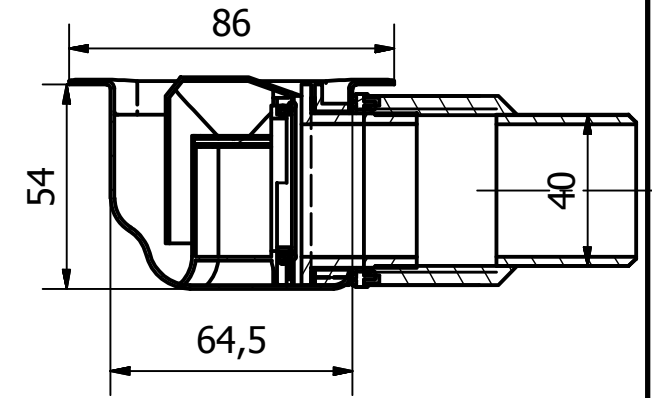

**I-DRAIN NEDERLAND B.V.**  
 Teugseweg 20 | 7418 AM Deventer  
 Postbus 131 | 7400 AC Deventer  
 T +31 (0)570 74 54 00 | E info@i-drain.nl  
[www.i-drain.nl](http://www.i-drain.nl)



PROJECT:ID4M11002X1	Tol: +/-	Datum:19/05/2010	A4
Omshrijving:	Tekenaar:Frederik	Aantal:	1/8
Goedkeuring:	Tekening:ID4M11002X1.DWG		Rev.4