

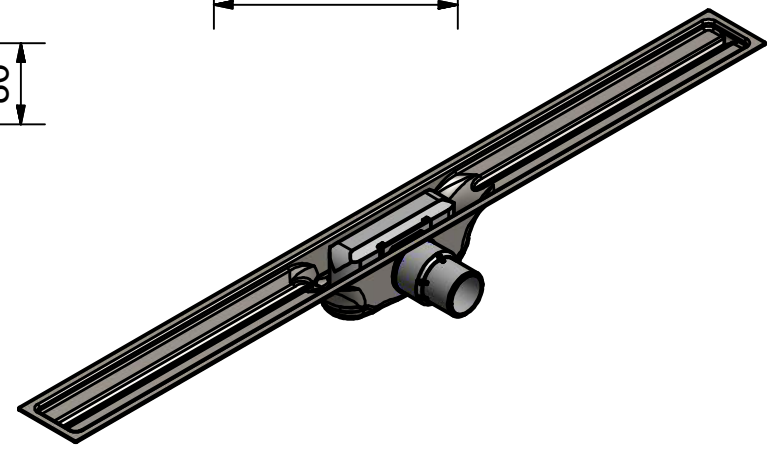

A'-A' (1/2)

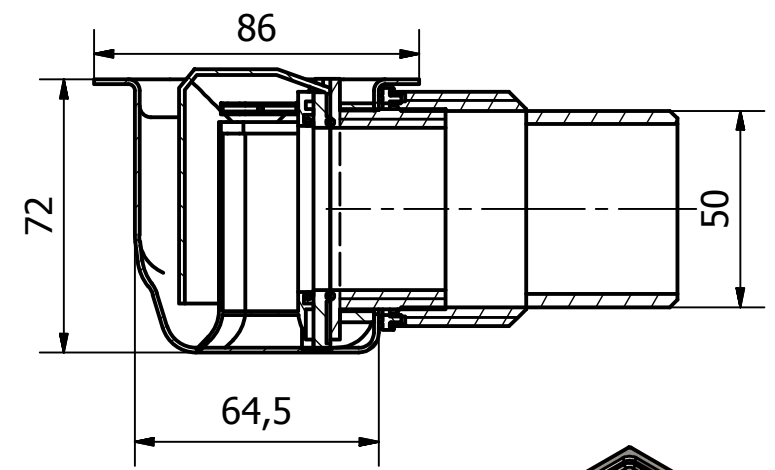

I-DRAIN NEDERLAND B.V.
 Teugseweg 20 | 7418 AM Deventer
 Postbus 131 | 7400 AC Deventer
 T +31 (0)570 74 54 00 | E info@i-drain.nl
www.i-drain.nl



PROJECT:ID5M10001X1	Tol: +/-	Datum:19/05/2010	A4
Omschrijving:	Tekenaar:Frederik	Aantal:	1/8
Goedkeuring:	Tekening:ID5M10001X1.DWG		Rev.4