

A-A (1/2)

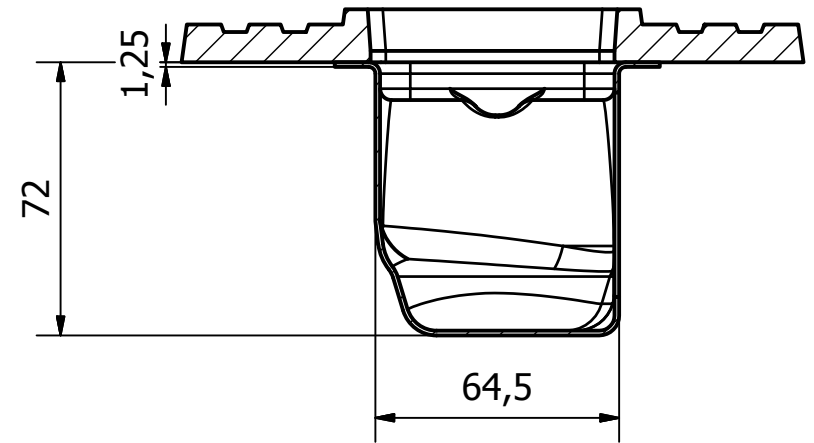

I-DRAIN NEDERLAND B.V.

Teugseweg 20 | 7418 AM Deventer
 Postbus 131 | 7400 AC Deventer
 T +31 (0)570 74 54 00 | E info@i-drain.nl
www.i-drain.nl



PROJECT:ED5.SS.0800	Tol: ISO-2768-C	Datum: 5/12/2017	A4
Omschrijving:ED5.SS.0800	Tekenaar: Jonas	Materiaal:	Schaal: 1/8
Goedkeuring:	Tekening:ED5.SS.0800.dwg		Rev.1